



RESULTS BOOK

KARATE1 YOUTH LEAGUE - CANCUN
2024

2024.08.08 - 2024.08.11

IBEROSTAR PLAYA PARAÍSO CONVENTION
CENTER, AVENIDA DEL SOL KM 309, PLAYA
PARAISO, 77710 RIVIERA MAYA

TABLE OF CONTENTS

NUMBER OF ENTRIES	4
ENTRYLIST	6
ENTRYLIST BY WEIGHT CATEGORY	24
STATISTICS	46
CADET KATA FEMALE	48
CADET KATA MALE	56
CADET KUMITE FEMALE -47 KG	64
CADET KUMITE FEMALE -54 KG	69
CADET KUMITE FEMALE -61 KG	74
CADET KUMITE FEMALE 61+ KG	79
CADET KUMITE MALE -52 KG	86
CADET KUMITE MALE -57 KG	93
CADET KUMITE MALE -63 KG	98
CADET KUMITE MALE -70 KG	106
CADET KUMITE MALE 70+ KG	114
JUNIOR KATA FEMALE	119
JUNIOR KATA MALE	127
JUNIOR KUMITE FEMALE -48 KG	135
JUNIOR KUMITE FEMALE -53 KG	140
JUNIOR KUMITE FEMALE -59 KG	145
JUNIOR KUMITE FEMALE -66 KG	150
JUNIOR KUMITE FEMALE 66+ KG	155
JUNIOR KUMITE MALE -55 KG	160
JUNIOR KUMITE MALE -61 KG	167
JUNIOR KUMITE MALE -68 KG	175
JUNIOR KUMITE MALE -76 KG	183
JUNIOR KUMITE MALE 76+ KG	191
U14 KATA FEMALE	198
U14 KATA MALE	206

U14 KUMITE FEMALE -42 KG	214
U14 KUMITE FEMALE -47 KG	219
U14 KUMITE FEMALE -52 KG	224
U14 KUMITE FEMALE 52+ KG	229
U14 KUMITE MALE +55 KG	234
U14 KUMITE MALE -40 KG	242
U14 KUMITE MALE -45 KG	247
U14 KUMITE MALE -50 KG	255
U14 KUMITE MALE -55 KG	260
U21 KATA FEMALE	265
U21 KATA MALE	273
U21 KUMITE FEMALE -50 KG	281
U21 KUMITE FEMALE -55 KG	286
U21 KUMITE FEMALE -61 KG	291
U21 KUMITE FEMALE -68 KG	296
U21 KUMITE FEMALE 68+ KG	301
U21 KUMITE MALE -60 KG	306
U21 KUMITE MALE -67 KG	313
U21 KUMITE MALE -75 KG	320
U21 KUMITE MALE -84 KG	325
U21 KUMITE MALE 84+ KG	330
OFFICIAL RESULTS	335



Karate1 Youth League - Cancun 2024

MEXICO

2024.08.08 - 2024.08.11

Iberostar Playa Paraíso Convention Center, Avenida del Sol Km 309, Playa Paraíso, 7



NUMBER OF ENTRIES

#	Code	Country	Male Entries	Female Entries	Total Entries	Total Athletes
1	ARG	ARGENTINA	1	0	1	1
2	ARU	ARUBA	2	0	2	2
3	AUS	AUSTRALIA	0	2	2	2
4	AUT	AUSTRIA	4	4	8	8
5	BEL	BELGIUM	2	1	3	3
6	BOL	BOLIVIA	0	1	1	1
7	BIH	BOSNIA AND HERZEGOVINA	0	1	1	1
8	BRA	BRAZIL	5	4	9	8
9	CAN	CANADA	14	17	31	29
10	CHI	CHILE	41	31	72	71
11	COL	COLOMBIA	16	13	29	28
12	CRC	COSTA RICA	28	21	49	32
13	CRO	CROATIA	5	5	10	10
14	CZE	CZECH REPUBLIC	4	0	4	2
15	DEN	DENMARK	1	3	4	4
16	DOM	DOMINICAN REPUBLIC	5	2	7	7
17	ECU	ECUADOR	3	1	4	4
18	ESA	EL SALVADOR	0	3	3	3
19	ENG	ENGLAND	8	4	12	12
20	EST	ESTONIA	1	0	1	1
21	FRA	FRANCE	4	3	7	7
22	GER	GERMANY	11	8	19	19
23	GRE	GREECE	2	0	2	2
24	GUA	GUATEMALA	9	5	14	13
25	HON	HONDURAS	1	0	1	1
26	HKG	HONG KONG, CHINA	2	0	2	1
27	ISL	ICELAND	1	1	2	2
28	IND	INDIA	1	0	1	1
29	IRI	ISLAMIC REPUBLIC OF IRAN	1	0	1	1
30	ITA	ITALY	10	5	15	15
31	JAM	JAMAICA	4	0	4	2
32	LAT	LATVIA	1	0	1	1
33	LUX	LUXEMBOURG	1	0	1	1
34	MLT	MALTA	0	2	2	2
35	MEX	MEXICO	118	64	182	160
36	NED	NETHERLANDS	0	2	2	2
37	NCA	NICARAGUA	3	1	4	4
38	PAN	PANAMA	1	0	1	1
39	PAR	PARAGUAY	8	2	10	10
40	PER	PERU	14	6	20	20
41	POL	POLAND	3	3	6	6
42	POR	PORTUGAL	9	10	19	19
43	PUR	PUERTO RICO	4	0	4	4
44	ROU	ROMANIA	2	0	2	2
45	SCO	SCOTLAND	0	1	1	1
46	SVK	SLOVAKIA	2	3	5	5



Karate1 Youth League - Cancun 2024









MEXICO

2024.08.08 - 2024.08.11

Iberostar Playa Paraíso Convention Center, Avenida del Sol Km 309, Playa Paraiso, 7



NUMBER OF ENTRIES

#	Code	Country	Male Entries	Female Entries	Total Entries	Total Athletes
47		SLO SLOVENIA	0	1	1	1
48		ESP SPAIN	9	6	15	15
49		SWE SWEDEN	2	1	3	3
50		SUI SWITZERLAND	14	2	16	13
51		TUN TUNISIA	0	1	1	1
52		UKR UKRAINE	0	1	1	1
53		USA UNITED STATES	54	32	86	67
54		VEN VENEZUELA	10	4	14	13
55		WAL WALES	1	0	1	1
Totals:			442	277	719	646



Karate1 Youth League - Cancun 2024



ENTRIES BY NOC

As of 11 AUG 2024

NOC Code	Gender	Name	Date Of Birth	Event	Seed
ARG	M	GALLARDO JUAN IGNACIO	14 JUL 2006	U21 Kumite Male -60 kg	
ARU	M	BOEKHOUDT NATHAN	10 AUG 2006	Junior Kumite Male -68 kg	
	M	PRADA SUNCO KEVEN	04 JAN 2005	U21 Kumite Male -67 kg	
AUS	F	CHOI LAWRENCE LUCY	26 OCT 2009	Cadet Kumite Female -47 kg	
	F	WIBOWO REBECCA	07 FEB 2011	U14 Kata Female	
AUT	M	PLATISA PASCAL	24 MAR 2008	Junior Kumite Male -68 kg	
	M	SELIMOVIC ARMIN	30 APR 2007	Junior Kumite Male 76+ kg	
	M	WU TIMON	01 FEB 2007	Junior Kata Male	
	M	ZADINA EMIL	28 MAR 2011	U14 Kata Male	
	F	CETIN CEYLIN	19 MAI 2008	Junior Kumite Female -59 kg	
	F	KEMETINGER SARAH	25 NOC 2009	Cadet Kumite Female 61+ kg	
	F	LEHNER TAMARA	28 JAN 2009	Cadet Kata Female	
	F	SCHUETZE EMMA	21 NOC 2005	U21 Kumite Female 68+ kg	
BEL	M	Ejja Amine	19 MAR 2006	U21 Kumite Male -67 kg	
	M	ROMBEAUX MATT	06 SEP 2007	Junior Kumite Male -61 kg	
	F	Ejja Iman	21 NOC 2004	U21 Kumite Female -55 kg	
BOL	F	LUNA PAOLA	08 JAN 2005	U21 Kumite Female -50 kg	
BIH	F	Omanović Lamija	20 MAI 2011	U14 Kumite Female 52+ kg	
BRA	M	Assunção João	16 AUG 2006	Junior Kumite Male -61 kg	
	M	Gonçalves Negri Pedro	14 SEP 2004	U21 Kumite Male -75 kg	
	M	LIBORIO GUSTAVO	21 JAN 2009	Cadet Kata Male	
	M	Miranda Vaz Murillo	12 DEC 2011	U14 Kata Male	
	M	Miranda Vaz Murillo	12 DEC 2011	U14 Kumite Male -45 kg	
	F	BISSOLI FERRI KUSTER AMANDA	21 FEB 2005	U21 Kata Female	
	F	Cardoso Letícia de Souza	07 JUL 2005	U21 Kata Female	
	F	Collela Yasmin	04 JUL 2008	Junior Kata Female	
	F	LINS BEATRIZ	20 NOC 2008	Cadet Kata Female	
CAN	M	Concepcion Dean	16 JUN 2011	U14 Kata Male	
	M	CRONJE JINICHI	05 FEB 2009	Cadet Kumite Male -70 kg	
	M	Danesh Daniel	24 JAN 2007	Junior Kumite Male -76 kg	
	M	Darveau Olivier	11 NOC 2004	U21 Kata Male	
	M	DE LANDA ZISKROUT ISAAC	31 MAR 2006	U21 Kumite Male 84+ kg	
	M	GRUITIA MATTHEW	08 MAR 2007	Junior Kata Male	
	M	Gunja Karim	09 MAR 2011	U14 Kata Male	
	M	HOBSON CHASE	19 FEB 2011	U14 Kumite Male -40 kg	
	M	HOBSON CHASE	19 FEB 2011	U14 Kata Male	
	M	Lee Christopher	04 JUL 2007	Junior Kumite Male -61 kg	
	M	Palanisamy Arun Adit	04 APR 2012	U14 Kumite Male -45 kg	
	M	RATHNAYAKE HELITHA	24 SEP 2006	Junior Kumite Male -55 kg	
	M	SAJADI PARSА	17 JUN 2011	U14 Kumite Male +55 kg	
	M	Singh Evan	29 SEP 2010	U14 Kumite Male -50 kg	
	F	BEAUDET ALICE	13 FEB 2010	Cadet Kumite Female -54 kg	
	F	CARTER BROOKLYN	16 OCT 2005	U21 Kata Female	
	F	Delarosa Kiara	02 JUN 2008	Junior Kumite Female -53 kg	
	F	Gill Sereya	21 JUL 2012	U14 Kumite Female -42 kg	



Karate1 Youth League - Cancun 2024



ENTRIES BY NOC

As of 11 AUG 2024

NOC Code	Gender	Name	Date Of Birth	Event	Seed
CAN	F	GUERRERO MARIANA	09 FEB 2009	Cadet Kumite Female 61+ kg	
	F	HOLLYBOW ANIKA	23 AUG 2007	Junior Kumite Female 66+ kg	
	F	Jawkar Aarya	02 JUL 2011	U14 Kumite Female -47 kg	
	F	JAWKAR ANUSHKA	16 FEB 2007	Junior Kumite Female -59 kg	
	F	Kudsi Masa	08 NOC 2004	U21 Kata Female	
	F	LAWRANCE SOPHIE	16 FEB 2005	U21 Kumite Female -61 kg	
	F	Lee Amanda	10 JUL 2008	Junior Kata Female	
	F	Lee Amanda	10 JUL 2008	Junior Kumite Female -59 kg	
	F	Nijjar Anisha	24 JUN 2007	Junior Kumite Female -59 kg	
	F	RAHMANI AYA	13 APR 2009	Cadet Kumite Female -61 kg	
	F	RATHNAYAKE MUTHULI	04 SEP 2010	U14 Kumite Female -47 kg	
	F	REGLAR EMILY	29 DEC 2004	U21 Kumite Female -55 kg	
	F	Silva Isabel	13 DEC 2009	Cadet Kata Female	
CHI	M	ADRIAZOLA REYES BENJAMIN	27 DEC 2006	Junior Kumite Male -68 kg	
	M	aguilera Martin	13 JUL 2007	Junior Kumite Male -55 kg	
	M	ARAOS SAGREDO MARTIN	24 JUN 2008	Junior Kumite Male -61 kg	
	M	Araya Astengo Joaquín Alonso	10 JAN 2010	Cadet Kumite Male -52 kg	
	M	ARCE ZUNIGA BASTIAN	30 MAI 2004	U21 Kumite Male -67 kg	
	M	ARRIAGADA PAVEZ INAKI	25 SEP 2009	Cadet Kumite Male -63 kg	
	M	BAHAMONDE AGUSTIN	22 AUG 2011	U14 Kumite Male -45 kg	
	M	BAHAMONDE MARTIN	17 NOC 2006	Junior Kumite Male -61 kg	
	M	Borquez Arancibia Abraham Guillermo	24 MAI 2010	Cadet Kata Male	
	M	BUSTAMANTE ALVARADO LEANDRO	17 JAN 2011	U14 Kumite Male +55 kg	
	M	CALISTO GASPAR	26 JUN 2008	Junior Kumite Male -68 kg	
	M	CAMINADA CATALÁN PHILLIP ANDREE	16 APR 2007	Junior Kumite Male -76 kg	
	M	Campusano Matías	18 DEC 2011	U14 Kumite Male +55 kg	
	M	CARRENO OLAVARRIA VICENTE	07 JAN 2010	Cadet Kumite Male -70 kg	
	M	Carrera Rubilar Lucian	07 MAI 2010	Cadet Kumite Male -57 kg	
	M	Carvajal Vergara Leonardo José	11 AUG 2007	Junior Kumite Male -68 kg	
	M	Concha Sepulveda Jorge	28 OCT 2009	Cadet Kumite Male 70+ kg	
	M	CONTRERAS ORTIZ LUCAS	13 OCT 2010	U14 Kumite Male -50 kg	
	M	CUEVAS NUNEZ JAVIER	21 MAI 2006	U21 Kumite Male -60 kg	
	M	Gálvez Tamayo Vicente Cristóbal	25 JAN 2007	Junior Kumite Male 76+ kg	
	M	HERMOSILLA KIRSTEN CRISTOBAL	12 JUN 2007	Junior Kumite Male -55 kg	
	M	HERNANDEZ NAVARRO MATHIAS	01 NOC 2011	U14 Kumite Male +55 kg	
	M	Jara Muñoz Maximiliano Ignacio	10 FEB 2006	U21 Kumite Male -67 kg	
M	LOBOS MACEDO RODRIGO	16 MAI 2009	Cadet Kumite Male -57 kg		
M	Macchiavello Ramírez Piero Alessandro	11 JUN 2010	Cadet Kumite Male -63 kg		
M	MARTINEZ SAGREDO LEON	22 SEP 2011	U14 Kumite Male -40 kg		
M	Mesina Fuentes Kevin Alexis	06 APR 2004	U21 Kata Male		
M	MIRALLES PINEDA MATEO	03 AUG 2011	U14 Kumite Male -50 kg		
M	Mondaca Rivera Esteban Vicente Andres	14 DEC 2007	Junior Kumite Male -68 kg		
M	MUÑOZ CONTRERAS SEBASTIAN	21 OCT 2008	Cadet Kumite Male -70 kg		



Karate1 Youth League - Cancun 2024



ENTRIES BY NOC

As of 11 AUG 2024

NOC Code	Gender	Name	Date Of Birth	Event	Seed
CHI	M	Navarrete Sebastián	20 OCT 2011	U14 Kumite Male -45 kg	
	M	OYARZUN BAHAMONDE ALONSO	02 MAR 2010	Cadet Kumite Male -52 kg	
	M	PAVEZ ALONSO	23 JAN 2008	Junior Kumite Male -68 kg	
	M	PEÑA RENATO	19 MAR 2008	Junior Kumite Male -76 kg	
	M	PONCE SOTO HECTOR	03 JAN 2006	U21 Kumite Male -84 kg	
	M	Puga rojas Emilio Alonso	19 JUL 2010	Cadet Kumite Male -52 kg	
	M	SALAS HERNANDEZ DILAN	16 FEB 2011	U14 Kumite Male +55 kg	
	M	SANCHEZ BAHAMONDE VICENTE	28 APR 2009	Cadet Kumite Male -52 kg	
	M	Sotomayor Villaroel Benjamin	30 MAR 2012	U14 Kumite Male -45 kg	
	M	Sotomayor Villaroel Benjamin	30 MAR 2012	U14 Kata Male	
	M	URDANETA VALENCIA ALBERTO	08 JUN 2006	U21 Kata Male	
	F	AGUILERA PEREZ PAULA	08 DEC 2009	Cadet Kumite Female 61+ kg	
	F	ALVARADO MYHELLEN	24 SEP 2009	Cadet Kumite Female 61+ kg	
	F	ANTIPA GONZALEZ MAILEN	22 JUL 2011	U14 Kumite Female 52+ kg	
	F	AROS REBOLLEDO EMILIA	11 JUL 2011	U14 Kumite Female 52+ kg	
	F	CAVICCHIOLI TOLEDO CAMILA	03 MAI 2007	Junior Kumite Female -59 kg	
	F	CAVICCHIOLI TOLEDO CONSTANZA	02 SEP 2010	U14 Kumite Female -47 kg	
	F	Contreras Villavicencio Bianca amyra	21 MAR 2010	Cadet Kumite Female -54 kg	
	F	De Luca Agustina Sofia	26 AUG 2008	Cadet Kata Female	
	F	DONOSO ALMONACID MAITE	27 MAR 2010	Cadet Kumite Female -61 kg	
	F	ECHEVERRIA VEGA BELÉN ANTONIA ALEXANDRA	22 DEC 2005	U21 Kumite Female -50 kg	
	F	flores cabrera francisca	05 MAI 2006	U21 Kumite Female -55 kg	
	F	GALLO ARAYA ISIDORA	06 JUN 2005	U21 Kata Female	
	F	GARAY SUAZO ISIDORA NOEMI	29 NOC 2007	Junior Kumite Female -66 kg	
	F	GATICA MORALES BELEN	18 SEP 2004	U21 Kumite Female -55 kg	
	F	GODOY MAGDALENA	22 SEP 2004	U21 Kumite Female -55 kg	
	F	LEIVA GAETE MAIRA	03 MAI 2006	U21 Kumite Female -50 kg	
	F	MELIAN PEREZ ANTONIA	02 JAN 2007	Junior Kumite Female -53 kg	
	F	Núñez Daniela	02 FEB 2009	Cadet Kumite Female 61+ kg	
	F	Oyarce Agustina	08 JUL 2009	Cadet Kumite Female -61 kg	
	F	PERALTA MARCO DANDARU IGNACIA	20 MAR 2008	Junior Kumite Female -66 kg	
	F	PERALTA MARCO José Ignacia	30 OCT 2004	U21 Kumite Female -68 kg	
	F	Puga Rojas Fiorentina Ignacia	16 JUN 2008	Junior Kumite Female 66+ kg	
	F	SALINAS ISIDORA CAROLINA	15 JUL 2005	U21 Kata Female	
	F	Sepúlveda Ly Flavia Emilia	03 DEC 2008	Cadet Kumite Female 61+ kg	
	F	Soto Catalina	07 AUG 2012	U14 Kumite Female -47 kg	
	F	SOTO SEPULVEDA MARTINA IGNACIA	25 JUN 2008	Junior Kumite Female 66+ kg	
	F	Valderrama Alvarez Fernanda Amaral	28 JUL 2011	U14 Kumite Female -42 kg	
	F	VEGA BUSTAMANTE AMANDA	11 APR 2012	U14 Kumite Female -52 kg	
	F	Vega ruz Isidora Agustina	24 APR 2010	Cadet Kumite Female 61+ kg	
F	Vera Gazmuri Martina	03 NOC 2009	Cadet Kumite Female 61+ kg		
F	Vergara Ramírez Martina Isidora	17 MAR 2004	U21 Kumite Female -61 kg		
COL	M	BAENA TAMAYO MATEO	22 NOC 2005	U21 Kumite Male -67 kg	



Karate1 Youth League - Cancun 2024



ENTRIES BY NOC

As of 11 AUG 2024

NOC Code	Gender	Name	Date Of Birth	Event	Seed	
COL	M	BOHORQUEZ CAUSIL JOSE LUIS	13 OCT 2007	Junior Kumite Male -61 kg		
	M	castillo velez matias	12 AUG 2009	Cadet Kata Male		
	M	cifuentes munar giancarlo	23 FEB 2009	Cadet Kumite Male -57 kg		
	M	GAMBOA NICOLAS	27 JUL 2006	U21 Kumite Male 84+ kg		
	M	gomez tobon jose david	15 APR 2005	U21 Kumite Male -75 kg		
	M	hernandez meneses joseph ferney	01 MAR 2006	U21 Kumite Male 84+ kg		
	M	MAINGUEZ NOGUERA JUAN CAMILO	27 NOC 2003	U21 Kumite Male -60 kg		
	M	Medina David	30 JUN 2004	U21 Kata Male		
	M	MONTOYA CARDOZO CESAR STIVEN	10 MAI 2005	U21 Kumite Male -75 kg		
	M	Olmos quintana Juan David	08 APR 2004	U21 Kumite Male -67 kg		
	M	Olmos quintana matheo	30 OCT 2007	Junior Kumite Male -76 kg		
	M	ospina soscue santiago	09 AUG 2005	U21 Kumite Male -84 kg		
	M	PASTRANA SANTANA JORDI JOSE	21 MAR 2004	U21 Kumite Male -60 kg		
	M	TOLEDO SEBASTIAN	15 DEC 2007	Junior Kumite Male -61 kg		
	M	TORDECILLA FELIPE	17 JAN 2010	Cadet Kumite Male -70 kg		
	F	AGUDELO MARIN MARIA ALEJANDRA	09 NOC 2004	U21 Kumite Female -61 kg		
	F	cardona grajales sara	26 DEC 2006	Junior Kumite Female -59 kg		
	F	cardona grajales sara	26 DEC 2006	Junior Kata Female		
	F	castaño rojo leidy daniela	16 JAN 2004	U21 Kata Female		
	F	gomez betancur ana maria	23 OCT 2005	U21 Kumite Female -61 kg		
	F	GOMEZ BUITRAGO MARIA JOSE	09 AUG 2004	U21 Kumite Female -55 kg		
	F	GUARIN SOFIA	27 JUL 2005	U21 Kumite Female 68+ kg		
	F	LONDONO ANDREA VALENTINA	03 NOC 2008	Cadet Kumite Female -54 kg		
	F	Lopez Bernal Maria Del Mar	21 JAN 2007	Junior Kumite Female -48 kg		
	F	MAYA NAYELIS	14 OCT 2004	U21 Kumite Female -61 kg		
	F	PEREZ SALAMANCA NATALIA	05 JAN 2012	U14 Kumite Female -42 kg		
	F	SANCHEZ QUICENO JULIETA	19 OCT 2006	Junior Kumite Female -53 kg		
	F	VALDERRAMA GARCIA VALERIA	23 MAI 2007	Junior Kumite Female -48 kg		
	CRC	M	ABELLAN ORLANDO	27 AUG 2006	Junior Kata Male	
		M	ABELLAN ORLANDO	27 AUG 2006	Junior Kumite Male -68 kg	
		M	ARAYA DANIEL	28 JUL 2008	Junior Kumite Male -76 kg	
		M	BONILLAS NICOLAS	11 MAR 2009	Cadet Kata Male	
M		BONILLAS NICOLAS	11 MAR 2009	Cadet Kumite Male -70 kg		
M		CARDENAS EDUARDO	04 JUN 2007	Junior Kumite Male 76+ kg		
M		CORRALES NATAN	24 JUL 2012	U14 Kumite Male -50 kg		
M		CORRALES NATAN	24 JUL 2012	U14 Kata Male		
M		GONZALES MOISES	23 DEC 2011	U14 Kumite Male -40 kg		
M		GONZALES MOISES	23 DEC 2011	U14 Kata Male		
M		JARA JOSHUA	05 JAN 2005	U21 Kumite Male -60 kg		
M		JIMENEZ MATIAS	28 JAN 2009	Cadet Kata Male		
M		JIMENEZ MATIAS	28 JAN 2009	Cadet Kumite Male -70 kg		
M		JIMENEZ NICOLAS	19 JAN 2011	U14 Kumite Male -50 kg		
M	JIMENEZ NICOLAS	19 JAN 2011	U14 Kata Male			
M	MEJIA SEBASTIAN	13 NOC 2009	Cadet Kata Male			
M	MEJIA SEBASTIAN	13 NOC 2009	Cadet Kumite Male -70 kg			



Karate1 Youth League - Cancun 2024



ENTRIES BY NOC

As of 11 AUG 2024

NOC Code	Gender	Name	Date Of Birth	Event	Seed
CRC	M	MURILLO DERECK	31 JUL 2009	Cadet Kata Male	
	M	MURILLO DERECK	31 JUL 2009	Cadet Kumite Male -63 kg	
	M	MURILLO JOSEPH	02 OCT 2006	Junior Kata Male	
	M	PALMA GABRIEL	20 MAR 2008	Junior Kumite Male -55 kg	
	M	RIVERA FABRICIO	09 OCT 2009	Cadet Kumite Male -63 kg	
	M	RODESNO DANIEL	24 SEP 2009	Cadet Kumite Male -57 kg	
	M	RODRIGUEZ DANIEL	19 JUN 2007	Junior Kata Male	
	M	RODRIGUEZ DANIEL	19 JUN 2007	Junior Kumite Male -61 kg	
	M	RODRIGUEZ SANTIAGO	24 OCT 2008	Cadet Kumite Male -63 kg	
	M	RODRIGUEZ SEBASTIAN	08 JUL 2008	Junior Kata Male	
	M	VILLALOBOS JUAN CAMILO	20 AUG 2010	U14 Kumite Male -50 kg	
	F	CALVO ARIELA	06 FEB 2007	Junior Kumite Female -59 kg	
	F	CALVO ARIELA	06 FEB 2007	Junior Kata Female	
	F	CORDERO MARIEL	29 JAN 2009	Cadet Kata Female	
	F	CORDERO MARIEL	29 JAN 2009	Cadet Kumite Female 61+ kg	
	F	DIAZ SOFIA	10 JAN 2008	Junior Kumite Female -66 kg	
	F	FERRETO JIMENEZ ANGHELINA	20 FEB 2008	Junior Kata Female	
	F	FERRETO JIMENEZ ANGHELINA	20 FEB 2008	Junior Kumite Female -53 kg	
	F	JIMENEZ MARIA	01 JAN 2007	Junior Kumite Female -53 kg	
	F	LOPEZ SASHA	25 JUN 2009	Cadet Kata Female	
	F	LOPEZ SASHA	25 JUN 2009	Cadet Kumite Female -47 kg	
	F	MORA ALFARO ALOIS	03 SEP 2008	Cadet Kata Female	
	F	MORA ALFARO ALOIS	03 SEP 2008	Cadet Kumite Female -61 kg	
	F	MORENO AMANDA	31 JUL 2007	Junior Kumite Female 66+ kg	
	F	RODRIGUEZ ISABELLA	20 MAI 2009	Cadet Kumite Female -47 kg	
	F	RODRIGUEZ MORENO NAHOMY	27 FEB 2009	Cadet Kata Female	
	F	RODRIGUEZ MORENO NAHOMY	27 FEB 2009	Cadet Kumite Female -54 kg	
	F	RUIZ CAMILA	08 NOC 2005	U21 Kata Female	
	F	SOLOMON ALANA	03 APR 2012	U14 Kata Female	
	F	SOLOMON ALANA	03 APR 2012	U14 Kumite Female -47 kg	
	F	VASQUEZ AMY	21 JUL 2010	Cadet Kumite Female -47 kg	
	F	VASQUEZ AMY	21 JUL 2010	Cadet Kata Female	
CRO	M	GONDI NIKOLA	11 AUG 2006	Junior Kumite Male 76+ kg	
	M	Mabić Filip	02 JUL 2008	Junior Kumite Male -61 kg	
	M	SLUKIC PETAR	11 JAN 2010	Cadet Kumite Male -70 kg	
	M	SOLTIC ERVIN	09 JUN 2009	Cadet Kumite Male 70+ kg	
	M	STRAHIJA SVEN	09 JUN 2007	Junior Kumite Male -76 kg	
	F	CACKO MIA	17 JUL 2005	U21 Kumite Female -61 kg	
	F	GRGUREVIC LEA	06 MAI 2008	Junior Kumite Female -66 kg	
	F	MAGDALENIC PAULINA	04 MAI 2009	Cadet Kumite Female -61 kg	
	F	STRAHIJA LAURA	17 JUN 2008	Junior Kumite Female -66 kg	
	F	TRSTENJAK AIDA	14 JUN 2008	Junior Kumite Female -48 kg	
CZE	M	Šťáhlavský David	19 AUG 2009	Cadet Kata Male	
	M	Šťáhlavský David	19 AUG 2009	Cadet Kumite Male -70 kg	
	M	Šťáhlavský Ondřej	11 MAR 2006	U21 Kumite Male -75 kg	
	M	Šťáhlavský Ondřej	11 MAR 2006	U21 Kata Male	
DEN	M	Linaa Mathias Bech	26 DEC 2004	U21 Kumite Male -67 kg	



Karate1 Youth League - Cancun 2024



ENTRIES BY NOC

As of 11 AUG 2024

NOC Code	Gender	Name	Date Of Birth	Event	Seed
DEN	F	Bath Astamaja	31 OCT 2007	Junior Kumite Female -66 kg	
	F	Bath Hannah	04 JAN 2010	Cadet Kumite Female -61 kg	
	F	Bath Sofia	31 OCT 2007	Junior Kumite Female -48 kg	
DOM	M	BERA BISONO EMIR	21 APR 2010	Cadet Kata Male	
	M	BERA BISONO YUSEF	18 FEB 2008	Junior Kata Male	
	M	CARBALLO JOSE	11 JUL 2012	U14 Kata Male	
	M	DISLA JOSE	30 JUL 2011	U14 Kata Male	
	M	SANCHEZ FIALLO JOSE GUILLERMO	14 AUG 2010	U14 Kata Male	
	F	GUZMAN VERGARA BELEN	05 DEC 2009	Cadet Kata Female	
	F	SALAZAR MONSERRAT	16 OCT 2008	Cadet Kata Female	
ECU	M	CHUCHUCA JARED	28 APR 2007	Junior Kumite Male -61 kg	
	M	NARVAEZ MARCO	29 MAR 2007	Junior Kata Male	
	M	PAEZ JOAQUIN	15 MAR 2005	U21 Kata Male	
	F	PAEZ AMELIA	14 JUN 2010	Cadet Kata Female	
ESA	F	CERROS ELENA ISABEL	23 FEB 2008	Junior Kata Female	
	F	FLORES RAMOS HAZEL SAMEIDY	24 APR 2006	U21 Kumite Female -55 kg	
	F	ORANTES MAGANA SOFIA ALEJANDRA	20 JUL 2004	U21 Kumite Female -50 kg	
ENG	M	Attard Zachary	14 OCT 2007	Junior Kumite Male -61 kg	
	M	Barnes Dylan	10 JAN 2005	U21 Kata Male	
	M	Black Joseph	15 OCT 2006	Junior Kumite Male -55 kg	
	M	Flounders Joseph	30 APR 2004	U21 Kumite Male -67 kg	
	M	McDade Chad	20 MAI 2004	U21 Kata Male	
	M	Monk Luke	23 MAI 2005	U21 Kumite Male -67 kg	
	M	Walker Ollie	30 MAR 2005	U21 Kumite Male -84 kg	
	M	Wilkins Logan	31 MAI 2007	Junior Kumite Male -68 kg	
	F	Allsopp Amber	18 FEB 2004	U21 Kumite Female 68+ kg	
	F	Fry Autumn	09 DEC 2007	Junior Kumite Female 66+ kg	
	F	HANDLEY SKYLA	02 SEP 2011	U14 Kumite Female 52+ kg	
F	Williams Danni	23 SEP 2004	U21 Kata Female		
EST	M	Mets Mihkel	26 AUG 2003	U21 Kumite Male -84 kg	
FRA	M	Adjanonhoun Ihsane	19 SEP 2008	Cadet Kumite Male 70+ kg	
	M	BOMPAS JANHAEL	17 SEP 2004	U21 Kata Male	
	M	HOFFMANN LUCAS	13 APR 2005	U21 Kata Male	
	M	NGUYEN Toan	19 SEP 2008	Cadet Kata Male	
	F	Ben Rabeh Aliya	02 NOC 2010	U14 Kumite Female -42 kg	
	F	BUI Mai-Linh	27 OCT 2006	Junior Kata Female	
	F	VAUCELLE-SPELLE Ninon	26 NOC 2008	Cadet Kata Female	
GER	M	Azadi Bijan	31 DEC 2011	U14 Kumite Male +55 kg	
	M	Gräfe Lukas	20 MAI 2011	U14 Kumite Male +55 kg	
	M	Grünelt Oliver	26 NOC 2010	U14 Kumite Male -45 kg	
	M	Heller Ben	04 JUL 2007	Junior Kumite Male -68 kg	
	M	Hoerner Paul-Willibald	11 APR 2009	Cadet Kumite Male -57 kg	
	M	Knopp Phil	13 JUL 2007	Junior Kumite Male -76 kg	



Karate1 Youth League - Cancun 2024



ENTRIES BY NOC

As of 11 AUG 2024

NOC Code	Gender	Name	Date Of Birth	Event	Seed
GER	M	Namyslik Felix	03 NOC 2009	Cadet Kumite Male -52 kg	
	M	Niederelz Tim	26 JAN 2009	Cadet Kumite Male -63 kg	
	M	Pagin Lukasz	02 OCT 2010	U14 Kumite Male +55 kg	
	M	Thierbach Luca	19 NOC 2007	Junior Kumite Male -68 kg	
	M	Zuniga Späthe Robin Mateo	05 JUN 2007	Junior Kumite Male -76 kg	
	F	Drehmann Emily-Chiara	17 JUL 2008	Junior Kumite Female -48 kg	
	F	Förster Alexia	09 JAN 2012	U14 Kumite Female -52 kg	
	F	Gräfe Lotte	12 JAN 2009	Cadet Kumite Female 61+ kg	
	F	Hellen Ili	24 APR 2008	Junior Kumite Female -59 kg	
	F	Hoerner Frieda	07 JUN 2012	U14 Kumite Female 52+ kg	
	F	Mussweiler Mia	07 DEC 2007	Junior Kumite Female -59 kg	
	F	Olschewski Hanna	24 DEC 2010	U14 Kumite Female -47 kg	
	F	Schindler Miley	02 JUL 2009	Cadet Kumite Female 61+ kg	
GRE	M	FILIAGKOS ATHANASIOS	24 FEB 2009	Cadet Kumite Male -52 kg	
	M	KARRAS PETROS	29 MAI 2007	Junior Kumite Male -61 kg	
GUA	M	CALDERON FERNANDO	11 AUG 2003	U21 Kata Male	
	M	Castillo Mazariego Jose Manuel	13 SEP 2005	U21 Kumite Male -60 kg	
	M	Castillo Mazariego Jose Manuel	13 SEP 2005	U21 Kata Male	
	M	CHACON MAZARIEGOS DIEGO ERNESTO	30 OCT 2005	U21 Kumite Male -67 kg	
	M	Diego Noriega Francisco David	14 JAN 2006	U21 Kata Male	
	M	FLORES ORTIZ JORGE DAMIAN	29 JUL 2009	Cadet Kumite Male -63 kg	
	M	GARCIA MONTT JOSE EMILIANO	06 JUN 2006	U21 Kumite Male -84 kg	
	M	MORALES SERRANO GERSHON ADIR	03 JUN 2007	Junior Kumite Male -76 kg	
	M	ROLDAN REYNA JOSE MIGUEL	14 JUL 2009	Cadet Kumite Male 70+ kg	
	F	AGUILAR ALBIZURES MARIA RENEE	29 JUL 2007	Junior Kumite Female -66 kg	
	F	COY AJU DAGNY NAHOMI	19 NOC 2008	Cadet Kumite Female -47 kg	
F	FLORES ORTIZ MARIA RENEE	24 NOC 2006	Junior Kumite Female -48 kg		
F	PALENCIA LUISA	13 OCT 2003	U21 Kumite Female -68 kg		
F	REYES REYNA EMILIA ESTER	04 NOC 2008	Cadet Kumite Female -61 kg		
HON	M	Torres Santos Henry Samael	11 APR 2008	Junior Kumite Male 76+ kg	
HKG	M	KWOK HO HIM	02 OCT 2005	U21 Kata Male	
	M	KWOK HO HIM	02 OCT 2005	U21 Kumite Male -67 kg	
ISL	M	Halldórsson Hugi	10 AUG 2005	U21 Kumite Male -84 kg	
	F	Halldórsdóttir Embla	30 DEC 2008	Cadet Kumite Female -61 kg	
IND	M	Agrawal Abhirraj	10 DEC 2009	Cadet Kumite Male -63 kg	
IRI	M	Nadimighasroldasht Alireza	30 NOC 2006	Junior Kata Male	
ITA	M	Camanzo Salvatore	20 SEP 2007	Junior Kata Male	
	M	CAPONERA Emanuele	07 JUN 2007	Junior Kata Male	
	M	CITI JACOPO	25 JUN 2008	Junior Kumite Male -68 kg	
	M	Di Rubba Luigi	10 APR 2007	Junior Kata Male	
	M	ederar karim	11 SEP 2006	Junior Kata Male	
	M	Ferraris Giacomo	13 OCT 2010	U14 Kumite Male -50 kg	
	M	MATACCHIONI LUIGI	13 JAN 2006	U21 Kata Male	



Karate1 Youth League - Cancun 2024



ENTRIES BY NOC

As of 11 AUG 2024

NOC Code	Gender	Name	Date Of Birth	Event	Seed
ITA	M	Ollagnero Giovanni	31 OCT 2007	Junior Kata Male	
	M	TONIOLO ALVISE	09 JUL 2007	Junior Kumite Male -68 kg	
	M	TURCATO GIACOMO FILIPPO	05 DEC 2009	Cadet Kata Male	
	F	ederar miriam	11 SEP 2006	Junior Kata Female	
	F	GATTA LINDA	19 AUG 2008	Cadet Kata Female	
	F	GENTA MICOL	08 NOC 2006	Junior Kumite Female -48 kg	
	F	Stangherlin Sofia	09 SEP 2006	Junior Kata Female	
	F	Tagliafierro Chiara	28 OCT 2004	U21 Kata Female	
JAM	M	EVANS RASANDRE VALENTINO	27 JUN 2010	Cadet Kumite Male -57 kg	
	M	EVANS RASANDRE VALENTINO	27 JUN 2010	Cadet Kata Male	
	M	EVANS VALENTINO RASANDRE	22 JAN 2012	U14 Kumite Male -45 kg	
	M	EVANS VALENTINO RASANDRE	22 JAN 2012	U14 Kata Male	
LAT	M	Ritenieks Olivers	18 APR 2008	Junior Kumite Male -68 kg	
LUX	M	Todorovic Filip	23 SEP 2009	Cadet Kumite Male -63 kg	
MLT	F	ANTONELLI THYIS	03 SEP 2008	Cadet Kumite Female 61+ kg	
	F	MADDEN LEIA-SUMMER	05 SEP 2011	U14 Kumite Female -47 kg	
MEX	M	ACOSTA PARICIO TOMAS	06 JAN 2011	U14 Kumite Male -55 kg	
	M	ALCAZAR RUIZ FRANCISCO JAVIER YASYDT	24 MAR 2011	U14 Kumite Male -40 kg	
	M	ALMEIDA CHAVEZ MARCO ANTONIO	07 JUL 2009	Cadet Kumite Male -52 kg	
	M	AMBROSIO PENA ROGELIO ANTONIO	16 MAI 2012	U14 Kumite Male -40 kg	
	M	ANDRADE MARTINEZ OWEN	12 DEC 2007	Junior Kumite Male -68 kg	
	M	ARTEAGA ESCALERA RICARDO	29 MAI 2007	Junior Kumite Male -55 kg	
	M	AVILA IBARRA SALVADOR	13 JUL 2005	U21 Kumite Male 84+ kg	
	M	BARAJAS ORTEGA EMILIANO	22 AUG 2007	Junior Kumite Male -68 kg	
	M	BAULCH LECA AIZEN	11 AUG 2010	U14 Kata Male	
	M	BAUTISTA ESTEBAN	14 SEP 2005	U21 Kumite Male -60 kg	
	M	BOJORQUEZ ARCE BRANDON VLADIMIR	16 MAR 2011	U14 Kumite Male -40 kg	
	M	BOJORQUEZ ARCE BRANDON VLADIMIR	16 MAR 2011	U14 Kata Male	
	M	BOJORQUEZ BRITO EDWARD ADRIAN	16 MAI 2009	Cadet Kumite Male -57 kg	
	M	CAAMAL PUC PEDRO RAFAEL	07 AUG 2012	U14 Kumite Male -55 kg	
	M	CABALLERO AQUINO LUIS ERNESTO	11 FEB 2012	U14 Kumite Male -45 kg	
	M	CAMPOS DESCIDERIO GENCO ANDRE	07 DEC 2008	Cadet Kumite Male 70+ kg	
	M	CARAVANTES MONTOYA ARIF ENRIQUE	05 DEC 2003	U21 Kumite Male -84 kg	
	M	CASTILLO CORTES ADRIAN	06 MAI 2006	U21 Kumite Male -60 kg	
	M	CASTILLO RAMOS RODRIGO	27 SEP 2004	U21 Kata Male	
	M	CERVANTES BANDA SEBASTIAN	17 APR 2009	Cadet Kumite Male -63 kg	
M	Cervantes Vazquez Vishwambar Jan	24 FEB 2011	U14 Kumite Male -45 kg		
M	CETINA VALLEJOS NOEL ABISAI	23 NOC 2011	U14 Kumite Male -45 kg		



Karate1 Youth League - Cancun 2024



ENTRIES BY NOC

As of 11 AUG 2024

NOC Code	Gender	Name	Date Of Birth	Event	Seed
MEX	M	CHAVEZ RAMIREZ Gerardo Gabriel	22 JUN 2011	U14 Kumite Male -55 kg	
	M	CORONA VAZQUEZ IVAN ALEJANDRO	06 JUL 2007	Junior Kumite Male -61 kg	
	M	CRUZ ROMERO DANIEL ALEJANDRO	15 JAN 2007	Junior Kumite Male -55 kg	
	M	CURIEL ALARCON SANTIAGO	28 MAI 2004	U21 Kumite Male -75 kg	
	M	D FLON VASQUEZ KAILASH TARIK	22 JAN 2012	U14 Kumite Male -45 kg	
	M	DE LA TORRE ROBLEDO LEONARDO	15 MAI 2007	Junior Kumite Male -61 kg	
	M	DELGADO SANCHEZ ALFONSO ANDRE	20 APR 2008	Junior Kumite Male -61 kg	
	M	DELGADO SANCHEZ ALFONSO ANDRE	20 APR 2008	Junior Kata Male	
	M	DELGADO SANCHEZ SAUL ALEJANDRO	21 AUG 2010	U14 Kata Male	
	M	DELGADO SANCHEZ SAUL ALEJANDRO	21 AUG 2010	U14 Kumite Male -55 kg	
	M	DOMINGUEZ HERNANDEZ ANGEL JULIAN	28 NOC 2007	Junior Kumite Male -61 kg	
	M	ESCOBAR CASILLAS PATRICK ALEXANDER	27 DEC 2007	Junior Kumite Male -55 kg	
	M	FREGOSO SUINAGA IKER	23 JUN 2008	Junior Kumite Male -55 kg	
	M	FUNES ANAYA PABLO JESUS	17 MAR 2005	U21 Kata Male	
	M	GALAVIZ GALAVIZ JORGE ERUBIEL	06 APR 2009	Cadet Kumite Male -63 kg	
	M	GALEOTE TIERRABLANCA ITAN SAID	29 JAN 2010	Cadet Kumite Male -52 kg	
	M	GARCIA GARCIA JESUS FRANCISCO	26 JUN 2006	U21 Kumite Male -84 kg	
	M	GARCIA ROCHA JOSE LUIS	28 OCT 2010	U14 Kumite Male +55 kg	
	M	GARCIA RODRIGUEZ ELIHUDD EMMANUEL	11 MAI 2009	Cadet Kumite Male -57 kg	
	M	GARCIA VALADEZ JUAN PABLO	28 APR 2007	Junior Kata Male	
	M	GARCIA VALADEZ MATEO	24 APR 2010	Cadet Kumite Male -52 kg	
	M	GARCÍA MENESES IGNACIO SALVADOR	12 SEP 2008	Cadet Kumite Male -63 kg	
	M	GARCÍA SANCHEZ DIEGO	19 DEC 2007	Junior Kumite Male -68 kg	
	M	GARZA CHAVARRIA FRANCISCO DEMIAN	17 MAI 2007	Junior Kumite Male 76+ kg	
	M	GARZA VIZCAINO JOSE MARCELO	09 OCT 2007	Junior Kata Male	
	M	GARZA VIZCAINO JOSE SANTIAGO	30 APR 2010	Cadet Kata Male	
	M	GARZA VIZCAINO JOSE SANTIAGO	30 APR 2010	Cadet Kumite Male -63 kg	
	M	GIL GONZALEZ PATRICIO	18 MAI 2012	U14 Kumite Male -50 kg	
	M	GOMEZ GONZALEZ JOSHUA ALI	20 MAI 2008	Junior Kumite Male -61 kg	
	M	GONZALEZ RAZO GABRIEL	13 JAN 2010	Cadet Kata Male	
	M	GUEVARA VALDEZ DANIEL ALEJANDRO	01 FEB 2010	Cadet Kata Male	
	M	GUEVARA VALDEZ DANIEL ALEJANDRO	01 FEB 2010	Cadet Kumite Male -52 kg	



Karate1 Youth League - Cancun 2024



ENTRIES BY NOC

As of 11 AUG 2024

NOC Code	Gender	Name	Date Of Birth	Event	Seed
MEX	M	GUTIERREZ MADRIGAL KAROL DANIEL	15 FEB 2005	U21 Kumite Male -75 kg	
	M	HERNANDEZ JIMENEZ JULIAN	01 SEP 2010	U14 Kumite Male -55 kg	
	M	HIGUERA ROMERO Carlos Francisco	09 DEC 2009	Cadet Kumite Male -63 kg	
	M	INIESTA MEZA HECTOR LEONARDO	21 JAN 2010	Cadet Kumite Male -52 kg	
	M	JANDA KOBROVA DOMINIK	29 NOC 2008	Cadet Kata Male	
	M	JANDA KOBROVA DOMINIK	29 NOC 2008	Cadet Kumite Male -70 kg	
	M	LEDESMA LUNA ISAAC RAFAEL	20 AUG 2005	U21 Kata Male	
	M	LEDESMA LUNA ISAAC RAFAEL	20 AUG 2005	U21 Kumite Male -75 kg	
	M	LOPEZ IBARRA EDER RENE	16 APR 2010	Cadet Kumite Male -70 kg	
	M	LOPEZ MUNOZ ANGEL IVAN	07 OCT 2007	Junior Kata Male	
	M	MACIAS CASTELLANOS JUAN PABLO	03 FEB 2007	Junior Kata Male	
	M	MERCADO DE ANDA Abraham	29 SEP 2010	U14 Kumite Male -50 kg	
	M	MERINO HERNADEZ JOSUE JACOB	11 SEP 2007	Junior Kumite Male -68 kg	
	M	MOJICA SOTO IAN NICKOLAS	06 JUN 2009	Cadet Kumite Male -70 kg	
	M	MONTANO MORALES EDUARDO	19 JUL 2007	Junior Kumite Male -76 kg	
	M	MORENO CANO JOSE DE JESUS	13 JUL 2007	Junior Kumite Male 76+ kg	
	M	MORENO FLORES GUILLERMO ZABDIEL	02 DEC 2006	Junior Kumite Male 76+ kg	
	M	OLIVAS ROMERO PABLO ANTONIO	01 JUL 2011	U14 Kumite Male +55 kg	
	M	OROZCO GALICIA DANTE ALEJANDRO	21 JAN 2008	Junior Kumite Male -68 kg	
	M	OROZCO GALICIA DANTE ALEJANDRO	21 JAN 2008	Junior Kata Male	
	M	OROZCO TORRES JOSE HUMBERTO	24 FEB 2011	U14 Kumite Male -50 kg	
	M	ORTEGA DESCIDERIO ANGEL JOSUE	01 APR 2008	Junior Kumite Male -76 kg	
	M	PADILLA GARCIA ISAAC GAEL	19 NOC 2004	U21 Kumite Male 84+ kg	
	M	PERERA TAMAY CHRISTOPHER JESUS	21 JUL 2009	Cadet Kumite Male 70+ kg	
	M	PEREZ GUTIERREZ MARCO ANTONIO	25 SEP 2008	Cadet Kumite Male 70+ kg	
	M	PEREZ KASUGA MARIO ALBERTO SHINJI	13 MAI 2011	U14 Kumite Male -40 kg	
	M	PEREZ LOPEZ SANTIAGO	17 NOC 2009	Cadet Kumite Male -57 kg	
	M	PEREZ MENDEZ FRANCISCO DANIEL	31 JUL 2011	U14 Kumite Male -55 kg	
	M	PONCE SANCHEZ FABBIO ALESSANDRO	26 AUG 2006	Junior Kumite Male -55 kg	
	M	PUEBLA GODOY GABRIEL TZAM	09 APR 2008	Junior Kumite Male 76+ kg	
	M	RAMOS DEL ANGEL ALFREDO	22 FEB 2010	Cadet Kata Male	
	M	RANGEL RANGEL GUSTAVO	16 MAI 2009	Cadet Kumite Male -57 kg	
	M	REBOLLEDO BRAVO ANDRE SALVADOR	10 JAN 2008	Junior Kumite Male -61 kg	
	M	REYNA CANO ORLANDO	02 JUN 2009	Cadet Kumite Male 70+ kg	
	M	RIVERO ARJONA DAYRON FERNANDO	14 AUG 2009	Cadet Kumite Male -63 kg	



Karate1 Youth League - Cancun 2024



ENTRIES BY NOC

As of 11 AUG 2024

NOC Code	Gender	Name	Date Of Birth	Event	Seed
MEX	M	ROBLES CASTRO CARLOS KALEB	12 MAI 2012	U14 Kumite Male -40 kg	
	M	ROBLES CASTRO CARLOS KALEB	12 MAI 2012	U14 Kata Male	
	M	rodriguez gonzalez miguel angel	03 MAI 2006	U21 Kumite Male 84+ kg	
	M	RODRIGUEZ PEREZ JAVIER ALEJANDRO	15 JAN 2008	Junior Kumite Male 76+ kg	
	M	RODRIGUEZ VALENCIA LUIS	16 JAN 2009	Cadet Kata Male	
	M	ROJAS SANCHEZ ARATH SAID	20 MAI 2006	U21 Kata Male	
	M	SALGADO RUEDA DIEGO	01 JAN 2010	Cadet Kumite Male -52 kg	
	M	SANCHEZ MONTENEGRO RUBEN	20 JUL 2007	Junior Kumite Male -76 kg	
	M	SANDOVAL SANDOVAL JOSE ANTONIO	18 APR 2007	Junior Kumite Male -76 kg	
	M	SANTIAGO ZAVALA AXEL MANUEL	19 AUG 2011	U14 Kumite Male -45 kg	
	M	SANTIAGO ZAVALA AXEL MANUEL	19 AUG 2011	U14 Kata Male	
	M	SANTIAGO ZAVALA LUIS EDUARDO	19 SEP 2007	Junior Kata Male	
	M	SANTIAGO ZAVALA LUIS EDUARDO	19 SEP 2007	Junior Kumite Male 76+ kg	
	M	SIXTO GARCIA IZEL OCELOTL	20 APR 2009	Cadet Kumite Male -57 kg	
	M	TAPIA SOLANO NICOLAS WINAJEL	13 OCT 2007	Junior Kumite Male -76 kg	
	M	Torres García Cesar Emiliano	30 JUL 2008	Junior Kumite Male -55 kg	
	M	VALERO HERNANDEZ ERIK ALEJANDRO	17 OCT 2009	Cadet Kumite Male 70+ kg	
	M	Vega Batiz Carlos Santiago	08 AUG 2005	U21 Kata Male	
	M	Vega Batiz Carlos Santiago	08 AUG 2005	U21 Kumite Male -67 kg	
	M	VELASCO MARQUEZ ALBERTO	12 MAR 2005	U21 Kumite Male 84+ kg	
	M	VELAZQUEZ OSUNA OLIVER LEONARDO	05 NOC 2010	U14 Kumite Male -55 kg	
	M	VELAZQUEZ OSUNA SERGIO EDUARDO	01 MAI 2007	Junior Kumite Male -61 kg	
	M	VIDEGARAY PEREZ PATRICIO	18 FEB 2004	U21 Kumite Male -67 kg	
	M	VILLAFANA VARGAS ALAN GERARDO	04 OCT 2007	Junior Kumite Male -76 kg	
	M	YOSHII MIZUKAMI HAYATO FRANCISCO	07 MAR 2006	U21 Kumite Male -75 kg	
	M	YOSHII MIZUKAMI HIROTO JAVIER	27 MAR 2004	U21 Kumite Male -67 kg	
	M	YOSHII MIZUKAMI KAITO DANIEL	08 MAR 2010	Cadet Kumite Male -57 kg	
	M	ZAVALA MERCADO JOSE JUAN	16 SEP 2007	Junior Kumite Male -76 kg	
	M	ZAVALA MERCADO JOSE JUAN	16 SEP 2007	Junior Kata Male	
	F	ALCAZAR CAMACHO Francés hannaely	30 DEC 2011	U14 Kumite Female -42 kg	
	F	BARROSO RIOS ASHLEY CAMILA	25 JUN 2008	Junior Kumite Female -66 kg	
	F	CABRERA PALOMINO GLORIA YESENIA	06 NOC 2007	Junior Kumite Female -48 kg	
	F	CARRILLO URDIALES CINTHIA RUBI	14 AUG 2004	U21 Kumite Female -50 kg	
	F	CATALAN BARRIENTOS ANETTE	04 DEC 2009	Cadet Kumite Female -47 kg	
	F	CATALAN BARRIENTOS ANETTE	04 DEC 2009	Cadet Kata Female	



Karate1 Youth League - Cancun 2024



ENTRIES BY NOC

As of 11 AUG 2024

NOC Code	Gender	Name	Date Of Birth	Event	Seed
MEX	F	CONTRERAS MUNOZ ANA KARENI	04 JUL 2007	Junior Kumite Female -53 kg	
	F	CRUZ CASTILLO PAOLA YAZMIN	20 DEC 2008	Cadet Kata Female	
	F	CRUZ LOPEZ FRIDA NAOMI	08 MAR 2009	Cadet Kata Female	
	F	DAVILA LOPEZ BARBARA ITZEL	07 JAN 2010	Cadet Kumite Female -61 kg	
	F	Dena Alvarez Joana María	16 APR 2004	U21 Kata Female	
	F	ESCOBEDO CASTAÑEDA METZTLI	10 JUL 2009	Cadet Kumite Female -54 kg	
	F	FRIAS CABRAL MELINA	01 JAN 2011	U14 Kumite Female 52+ kg	
	F	GARCIA ARELLANO NAOMI ALOTL	22 OCT 2010	U14 Kumite Female 52+ kg	
	F	GARCIA ARELLANO NAOMI ALOTL	22 OCT 2010	U14 Kata Female	
	F	GARCIA PACHECO REGINA ESTELA	05 OCT 2005	U21 Kumite Female -55 kg	
	F	GARCIA PACHECO REGINA ESTELA	05 OCT 2005	U21 Kata Female	
	F	GARZA VIZCAINO MARIA VICTORIA	13 OCT 2011	U14 Kumite Female -42 kg	
	F	GARZA VIZCAINO MARIA VICTORIA	13 OCT 2011	U14 Kata Female	
	F	GARZA VIZCAINO VALENTINA	12 NOC 2008	Cadet Kumite Female -54 kg	
	F	HERNANDEZ DIAZ NAOMY	23 DEC 2008	Cadet Kata Female	
	F	HERNANDEZ DIAZ NAOMY	23 DEC 2008	Cadet Kumite Female 61+ kg	
	F	HERNANDEZ QUIROZ ROBERTA	06 JUN 2012	U14 Kumite Female -47 kg	
	F	HERNANDEZ QUIROZ ROBERTA	06 JUN 2012	U14 Kata Female	
	F	HERNANDEZ VAZQUEZ DAFNE YARETZI	01 MAI 2010	Cadet Kumite Female 61+ kg	
	F	HERNANDEZ YANEZ FRIDA NICOLE	04 SEP 2011	U14 Kumite Female -52 kg	
	F	HERRERA AYALA ANA CAROLINA	23 JUN 2005	U21 Kumite Female -55 kg	
	F	JUAREZ MARTINEZ VALERIA LINETT	25 DEC 2008	Cadet Kumite Female 61+ kg	
	F	Lopez Cerro Ingrid Vanessa	24 JAN 2010	Cadet Kumite Female 61+ kg	
	F	LOPEZ SERRATOS KATIA DANIELA	20 SEP 2004	U21 Kumite Female -61 kg	
	F	MARTINEZ ZAPATA ANA YURIDIA	09 SEP 2005	U21 Kata Female	
	F	MENDEZ MAYEN ALONDRA ELIZABETH	12 AUG 2004	U21 Kumite Female -68 kg	
	F	MENDOZA PEREZ XADANI XIOMARA	24 AUG 2008	Cadet Kumite Female 61+ kg	
	F	NIETO FLORES IDALIA KARIME	17 AUG 2004	U21 Kumite Female -55 kg	
	F	NORMAN PORTILLA KATHERINNE MARYCIELO	25 MAI 2007	Junior Kata Female	
	F	NORMAN PORTILLA KATHERINNE MARYCIELO	25 MAI 2007	Junior Kumite Female -53 kg	
	F	PATRICIO GAYOSSO REGINA	04 NOC 2011	U14 Kata Female	
	F	PENA CARRILLO SARA CAMILA	17 MAR 2008	Junior Kata Female	
	F	Perez Gonzalez Nahomi Dayana	11 SEP 2010	U14 Kata Female	
	F	PLIEGO MALDONADO ESTEFANY QUETZALLI	13 FEB 2009	Cadet Kata Female	
	F	QUINTERO AVAS CIELO	14 FEB 2006	U21 Kumite Female -68 kg	
	F	QUINTERO AVAS CIELO	14 FEB 2006	U21 Kata Female	



Karate1 Youth League - Cancun 2024



ENTRIES BY NOC

As of 11 AUG 2024

NOC Code	Gender	Name	Date Of Birth	Event	Seed
MEX	F	QUINTERO AVAS YUBIA MARINA	21 AUG 2008	Cadet Kumite Female -54 kg	
	F	QUINTERO AVAS YUBIA MARINA	21 AUG 2008	Cadet Kata Female	
	F	QUINTERO FLORES GEOMARA	11 NOC 2007	Junior Kumite Female -66 kg	
	F	RAMIREZ MIRANDA FERNANDA MARISOL	22 DEC 2008	Cadet Kumite Female -61 kg	
	F	RAMOS ALONSO RENATA	24 AUG 2007	Junior Kumite Female -59 kg	
	F	RAMOS VAZQUEZ Paloma Judith	07 AUG 2009	Cadet Kata Female	
	F	REYNA CANO AYLIN YAMILET	09 JUN 2007	Junior Kumite Female -53 kg	
	F	RIVERA RODRIGUEZ JADE GETSEMANI	10 MAR 2012	U14 Kumite Female -52 kg	
	F	RODRIGUEZ RIOS ZARA ABIGAIL	16 OCT 2009	Cadet Kata Female	
	F	ROSALES MATA GEMA SELENIA	05 APR 2010	Cadet Kumite Female -47 kg	
	F	RUIZ PEREZ MARIA FERNANDA	11 NOC 2010	U14 Kumite Female 52+ kg	
	F	SAAVEDRA AGUIRRE VALERIA	01 SEP 2005	U21 Kumite Female -61 kg	
	F	SALINAS HERNANDEZ EMILIA	20 JAN 2005	U21 Kumite Female -50 kg	
	F	SANCHEZ GRUJIC ANA CAROLINA	12 JUN 2009	Cadet Kumite Female 61+ kg	
	F	SERRANO JIMENEZ SOPHIA YAHILI	06 AUG 2010	Cadet Kumite Female -61 kg	
	F	SOLIS PAT MARIA JOSE	01 SEP 2009	Cadet Kumite Female -61 kg	
	F	SORIA ESQUIVEL ANA SOFIA	23 OCT 2003	U21 Kumite Female -68 kg	
	F	TAPIA GONZALEZ ALEXA ELIZABETH	11 OCT 2008	Cadet Kata Female	
	F	TERAN GOMEZ AMERICA NAOMI	11 OCT 2006	Junior Kata Female	
	F	VALDES LEYVA RAQUEL	06 JUL 2004	U21 Kata Female	
F	VALDES LEYVA RAQUEL	06 JUL 2004	U21 Kumite Female -68 kg		
F	VALLEJOS CAAMAL REBECA CATALINA	16 JAN 2009	Cadet Kumite Female -54 kg		
NED	F	Valk Imane	11 APR 2008	Junior Kumite Female -66 kg	
	F	YALCIN Samina	21 JUN 2005	U21 Kumite Female -50 kg	
NCA	M	JULIO ROMERO BERMUDEZ	20 DEC 2006	Junior Kumite Male -68 kg	
	M	MOLINA GARAY MATHEUS	22 OCT 2007	Junior Kumite Male -76 kg	
	M	MONTEALEGRE VILLELA OSCAR GUSTAVO	15 MAI 2012	U14 Kumite Male -50 kg	
	F	PAULINA RIOS CHAVARRIA	14 MAR 2009	Cadet Kumite Female -47 kg	
PAN	M	JAEN ANTHONY	04 JUL 2010	Cadet Kata Male	
PAR	M	ALCARAZ LEANDRO	20 NOC 2009	Cadet Kumite Male -70 kg	
	M	BRITOS IVAN	15 OCT 2004	U21 Kumite Male 84+ kg	
	M	FLORENTIN IVAN	02 NOC 2006	Junior Kumite Male -55 kg	
	M	LOPEZ ENZO	24 AUG 2006	Junior Kumite Male -61 kg	
	M	MARTINEZ ALBARO	27 DEC 2010	U14 Kumite Male -50 kg	
	M	RINCK DIETER	08 JAN 2005	U21 Kumite Male -67 kg	
	M	SANCHEZ CAMILO	02 APR 2007	Junior Kumite Male 76+ kg	
	M	SANCHEZ DARDO	20 MAI 2008	Junior Kumite Male -68 kg	
	F	BENITEZ LUCIA	30 MAR 2012	U14 Kumite Female 52+ kg	
	F	MENCIA JAZMIN	16 AUG 2007	Junior Kumite Female -53 kg	
PER	M	Alvarez Romero Emanuel	15 NOC 2007	Junior Kumite Male -61 kg	
	M	Arosquipa Quispe Wilbert	19 OCT 2008	Cadet Kumite Male -63 kg	



Karate1 Youth League - Cancun 2024



ENTRIES BY NOC

As of 11 AUG 2024

NOC Code	Gender	Name	Date Of Birth	Event	Seed
PER	M	ASALDE MENDOZA PABLO EMMANUEL	16 JUN 2010	Cadet Kumite Male -70 kg	
	M	BACHOIR VEGA ANDRE LOUIS	03 APR 2006	U21 Kumite Male -75 kg	
	M	Ccoillo Ferrante Adriano Tadeo	13 NOC 2010	U14 Kumite Male -55 kg	
	M	Correa Berru Thiago Mathias	25 MAI 2009	Cadet Kumite Male -57 kg	
	M	HIGUCHI KEN	27 DEC 2003	U21 Kata Male	
	M	Honorio Velasco Alvaro Manuel	17 MAR 2011	U14 Kumite Male +55 kg	
	M	ITURBE PAUCAR THIAGO GAEL	15 NOC 2009	Cadet Kumite Male -52 kg	
	M	Lavado Rojas Giordano Ghael	21 JUL 2012	U14 Kumite Male -40 kg	
	M	LAVADO ROJAS VALENTINO YAEL	13 JUN 2010	Cadet Kumite Male -63 kg	
	M	Mejia Ignacio	07 SEP 2005	U21 Kata Male	
	M	TUCTO SANCHEZ JUAN DIEGO	30 DEC 2003	U21 Kumite Male -60 kg	
	M	Urbina Carranza Gonzalo	04 OCT 2007	Junior Kumite Male -68 kg	
	F	Congona Leon Geraldine Nicole	12 MAI 2009	Cadet Kumite Female -61 kg	
	F	Honorio Velasco Doris Fabiana	23 MAI 2006	U21 Kumite Female 68+ kg	
	F	La Serna Hilario Grecia Beatriz	25 AUG 2010	U14 Kumite Female -52 kg	
	F	Valdivia Monzon Alexandra Sofia	31 DEC 2005	U21 Kata Female	
	F	Vásquez Peña Astrid	03 NOC 2011	U14 Kumite Female -47 kg	
	F	Yuffra Mirez Luana María	08 AUG 2011	U14 Kumite Female -52 kg	
	POL	M	Dziuda Dominik	22 JUN 2005	U21 Kumite Male -67 kg
M		OLICHWER NATAN	10 APR 2008	Junior Kumite Male -55 kg	
M		WAWER WOJCIECH	26 SEP 2009	Cadet Kata Male	
F		CHLEBOWSKA ANNA	26 JAN 2007	Junior Kumite Female -53 kg	
F		Criou Eva	24 DEC 2004	U21 Kumite Female -61 kg	
F		Dopieralska Zuzanna	12 APR 2007	Junior Kumite Female -53 kg	
POR		M	Alves Rafael	23 JAN 2004	U21 Kumite Male -67 kg
	M	Fernandes Bernardo Pineu	18 APR 2004	U21 Kumite Male -75 kg	
	M	Fernandes Santiago Pinéu	30 OCT 2007	Junior Kumite Male -55 kg	
	M	Gonçalves Guilherme	06 MAI 2005	U21 Kumite Male -67 kg	
	M	Inacio Diogo	01 SEP 2005	U21 Kumite Male -75 kg	
	M	Matos Pedro	06 APR 2006	U21 Kata Male	
	M	Oliveira Gustavo	25 MAR 2006	U21 Kumite Male -60 kg	
	M	Oliveira Martim	22 JUN 2008	Junior Kata Male	
	M	Teixeira Pena André Filipe	03 AUG 2009	Cadet Kumite Male -57 kg	
	F	Cadete Beatriz	10 JUL 2008	Junior Kumite Female -66 kg	
	F	Cardoso Maria	23 NOC 2004	U21 Kata Female	
	F	Fernandes Ema Pinéu	14 JUN 2009	Cadet Kumite Female -47 kg	
	F	Gonçalves Leonor	28 APR 2009	Cadet Kumite Female -54 kg	
	F	Marques Rita	02 AUG 2008	Junior Kata Female	
	F	Martins Rita	27 JAN 2005	U21 Kata Female	
	F	Matos Isis	13 DEC 2008	Cadet Kumite Female -47 kg	
	F	OLIVEIRA INÊS	22 JUN 2007	Junior Kata Female	
F	Silva Maria	18 SEP 2008	Cadet Kumite Female -54 kg		
F	Varanda Gabriela	15 JUL 2009	Cadet Kumite Female -54 kg		
PUR	M	Almodovar Marin Diego	23 APR 2009	Cadet Kumite Male -57 kg	
	M	Molina Ortiz Oscar	04 MAR 2008	Junior Kumite Male -76 kg	
	M	Montañes Adorno Arturo Andres	14 JUL 2008	Junior Kumite Male -55 kg	



Karate1 Youth League - Cancun 2024



ENTRIES BY NOC

As of 11 AUG 2024

NOC Code	Gender	Name	Date Of Birth	Event	Seed
PUR	M	Rivera Rivera Ricardo Jeniel	21 JAN 2010	Cadet Kumite Male -63 kg	
ROU	M	BOGZA GABRIEL	09 MAR 2008	Junior Kumite Male -68 kg	
	M	GOATA MATEI	12 OCT 2004	U21 Kumite Male -60 kg	
SCO	F	Ewing Maia	18 FEB 2009	Cadet Kumite Female 61+ kg	
SVK	M	Mitrik Richard	09 MAR 2010	Cadet Kumite Male 70+ kg	
	M	VERCIMAK MARTIN	12 AUG 2011	U14 Kata Male	
	F	Jalowiczorova Veronika	11 JAN 2007	Junior Kumite Female -48 kg	
	F	KADLECAJOVA Viktoria	18 OCT 2007	Junior Kata Female	
	F	Zeumerova Alexandra	01 AUG 2008	Junior Kumite Female -66 kg	
SLO	F	Muzik Taša Mau	12 FEB 2006	U21 Kumite Female 68+ kg	
ESP	M	BENITEZ MORENO FRANCISCO	23 JAN 2011	U14 Kumite Male -55 kg	
	M	Castro López Braulio	14 AUG 2010	U14 Kata Male	
	M	Gomez Jimenez Francisco Javier	21 FEB 2012	U14 Kumite Male +55 kg	
	M	Leal Moreno Iker	12 JUN 2007	Junior Kumite Male -76 kg	
	M	Mazo Marco	03 FEB 2010	Cadet Kumite Male 70+ kg	
	M	MIRESAN SECHEI CRISTIAN ALEXANDRU	09 DEC 2006	Junior Kumite Male 76+ kg	
	M	MUÑOZ MACIAS LUIS	21 SEP 2007	Junior Kumite Male -61 kg	
	M	PETAGNA LOPEZ PAOLO	18 AUG 2009	Cadet Kumite Male -52 kg	
	M	Ruiz Ruiz José Luis	29 DEC 2006	Junior Kumite Male 76+ kg	
	F	Castro López Rocío	28 MAR 2009	Cadet Kata Female	
	F	Mazariegos Iglesias Esther	03 MAR 2011	U14 Kumite Female -52 kg	
	F	Mazariegos Iglesias Irene	16 AUG 2006	Junior Kumite Female -66 kg	
	F	MELGAR POSTIGO JULIA MARIA	19 MAR 2011	U14 Kumite Female -52 kg	
	F	SKIBA BIRKELBACH AMELIE YAIZA	20 DEC 2009	Cadet Kumite Female -61 kg	
	F	VIZCAINO CALVO RUTH	08 MAR 2007	Junior Kumite Female -53 kg	
SWE	M	Erhardt Truls	18 OCT 2009	Cadet Kata Male	
	M	Jonasson Jakob	02 JAN 2009	Cadet Kata Male	
	F	Nyman Agnes	14 NOC 2007	Junior Kumite Female -48 kg	
SUI	M	Debost Gaspard	22 JAN 2008	Junior Kumite Male -61 kg	
	M	Lorenz Swan	31 OCT 2006	Junior Kumite Male -68 kg	
	M	Lüthy Corsin Dion	16 APR 2010	Cadet Kumite Male -52 kg	
	M	Lüthy Corsin Dion	16 APR 2010	Cadet Kata Male	
	M	Mateus Gomes Cristiano	28 DEC 2008	Cadet Kata Male	
	M	Mateus Gomes Cristiano	28 DEC 2008	Cadet Kumite Male -52 kg	
	M	Mateus Gomes Leonardo	28 MAI 2010	Cadet Kumite Male -52 kg	
	M	Mateus Gomes Leonardo	28 MAI 2010	Cadet Kata Male	
	M	Patricio-Clémont Johan	18 AUG 2009	Cadet Kumite Male -57 kg	
	M	PETRONE Leandro	08 MAR 2005	U21 Kata Male	
	M	Schedel Keni	16 NOC 2004	U21 Kata Male	
	M	Schedel Nolan	14 APR 2008	Junior Kata Male	
	M	Torres Steven	02 AUG 2006	U21 Kumite Male -67 kg	
	M	Zecca Lucas	01 DEC 2009	Cadet Kumite Male -52 kg	
	F	Schedel Kaena	23 SEP 2010	U14 Kata Female	
	F	Tschanz Olivia	13 JAN 2005	U21 Kata Female	



Karate1 Youth League - Cancun 2024



ENTRIES BY NOC

As of 11 AUG 2024

NOC Code	Gender	Name	Date Of Birth	Event	Seed
TUN	F	Ettaleb Meriame	06 SEP 2006	Junior Kumite Female 66+ kg	
UKR	F	Afendikova Nika	03 AUG 2009	Cadet Kata Female	
USA	M	Adi David	24 MAI 2005	U21 Kata Male	
	M	BARNABEI MASSIMO	08 JUN 2012	U14 Kumite Male -40 kg	
	M	BARNABEI MASSIMO	08 JUN 2012	U14 Kata Male	
	M	Belfand Paul	18 APR 2009	Cadet Kumite Male -52 kg	
	M	Blunck August	07 JUL 2008	Junior Kumite Male -61 kg	
	M	Bonetti Akiau Luigi	22 SEP 2011	U14 Kumite Male -45 kg	
	M	Bonetti Akiau Luigi	22 SEP 2011	U14 Kata Male	
	M	Buka Yan	16 SEP 2005	U21 Kumite Male -84 kg	
	M	Corao Luis	11 AUG 2007	Junior Kumite Male -68 kg	
	M	Corbin Joshua	24 MAI 2006	U21 Kata Male	
	M	Corbin Joshua	24 MAI 2006	U21 Kumite Male -75 kg	
	M	Cruz Bryan	05 SEP 2006	Junior Kumite Male -61 kg	
	M	Cruz Kevin	06 DEC 2004	U21 Kumite Male -60 kg	
	M	Davila Martin	09 SEP 2009	Cadet Kata Male	
	M	Davila Martin	09 SEP 2009	Cadet Kumite Male -70 kg	
	M	Dolinyan Davit	06 FEB 2006	U21 Kumite Male -60 kg	
	M	Dorta Janco	27 MAI 2004	U21 Kumite Male -60 kg	
	M	Dorta Jean	11 MAI 2006	U21 Kumite Male -60 kg	
	M	Farris Logan	03 APR 2009	Cadet Kumite Male -63 kg	
	M	Isa Cheon	02 OCT 2008	Cadet Kata Male	
	M	Jackson Isaiah	21 SEP 2009	Cadet Kumite Male 70+ kg	
	M	Kasturi Sahil	12 JUL 2004	U21 Kumite Male -75 kg	
	M	Lopez Zack	30 SEP 2007	Junior Kumite Male -61 kg	
	M	Merrell Grayson	21 JUL 2007	Junior Kumite Male -76 kg	
	M	Molinero Michael	17 AUG 2007	Junior Kumite Male 76+ kg	
	M	Nacu Mateo	23 MAI 2007	Junior Kumite Male -61 kg	
	M	Nacu Mateo	23 MAI 2007	Junior Kata Male	
	M	Nguyen Andersen	03 NOC 2009	Cadet Kata Male	
	M	Nguyen Andersen	03 NOC 2009	Cadet Kumite Male -70 kg	
	M	Nunez Aaron	08 JUN 2010	Cadet Kata Male	
	M	Nunez Aaron	08 JUN 2010	Cadet Kumite Male -52 kg	
	M	Ochoa Ken	04 AUG 2008	Junior Kumite Male -55 kg	
	M	OUSMANE NIANG	29 OCT 2010	U14 Kumite Male +55 kg	
	M	Quackenbush Eric	23 JUN 2006	U21 Kata Male	
	M	Ricotti Luca	05 OCT 2006	Junior Kata Male	
	M	River Ariel	06 NOC 2007	Junior Kumite Male -68 kg	
	M	Salgado Gomez Santiago	08 JUL 2010	Cadet Kata Male	
	M	Salgado Gomez Santiago	08 JUL 2010	Cadet Kumite Male -52 kg	
	M	Sanchez Luis	18 JUN 2012	U14 Kata Male	
	M	Sanchez Luis	18 JUN 2012	U14 Kumite Male -45 kg	
	M	Santos Lance	04 JUN 2008	Junior Kata Male	
	M	Sattanathan Sivanandh	17 JAN 2012	U14 Kumite Male -45 kg	
	M	Sattanathan Sivanandh	17 JAN 2012	U14 Kata Male	
	M	Saunders-Long Tristan	25 MAI 2004	U21 Kumite Male -84 kg	
	M	Seitz Brayden	28 AUG 2007	Junior Kata Male	



Karate1 Youth League - Cancun 2024



ENTRIES BY NOC

As of 11 AUG 2024

NOC Code	Gender	Name	Date Of Birth	Event	Seed
USA	M	SEKOU BEN STEPHAN TIMITE	04 JUL 2011	U14 Kumite Male -45 kg	
	M	Serafimovich Lucas	01 MAI 2008	Junior Kumite Male -61 kg	
	M	Shaikh Aariz	23 MAI 2012	U14 Kumite Male -40 kg	
	M	Shaikh Ryaz	23 MAI 2012	U14 Kumite Male -40 kg	
	M	Solis Mateo	23 SEP 2004	U21 Kumite Male -67 kg	
	M	Twaddell Xander	10 OCT 2006	Junior Kata Male	
	M	White Jared	23 MAI 2005	U21 Kumite Male 84+ kg	
	M	WILSON TAVERAS	20 JAN 2010	Cadet Kumite Male -63 kg	
	M	Wood Landen	11 JAN 2007	Junior Kumite Male -76 kg	
	F	Abu-Rahma Mariam	21 OCT 2009	Cadet Kumite Female -47 kg	
	F	Andreevski Angelina	07 JUL 2010	Cadet Kumite Female -54 kg	
	F	Andreevski Angelina	07 JUL 2010	Cadet Kata Female	
	F	Andreevski Kalina	12 JUN 2012	U14 Kata Female	
	F	Andreevski Kalina	12 JUN 2012	U14 Kumite Female -42 kg	
	F	Arcalean Mihaela	09 MAR 2011	U14 Kumite Female -52 kg	
	F	Balint Elina	01 AUG 2011	U14 Kumite Female -47 kg	
	F	Cottingham Emmersyn	21 NOC 2008	Cadet Kata Female	
	F	Deodhari Sierra	04 OCT 2008	Cadet Kata Female	
	F	Guaitarilla Kamila	13 OCT 2008	Cadet Kata Female	
	F	Guaitarilla Kamila	13 OCT 2008	Cadet Kumite Female -54 kg	
	F	Harling Skyla	08 MAR 2009	Cadet Kumite Female 61+ kg	
	F	Hong Sophia	28 APR 2010	Cadet Kumite Female 61+ kg	
	F	Hong Sophia	28 APR 2010	Cadet Kata Female	
	F	Jennings Destiny	09 SEP 2005	U21 Kumite Female 68+ kg	
	F	Jocic Alexa	22 SEP 2006	Junior Kata Female	
	F	Jocic Alexa	22 SEP 2006	Junior Kumite Female -48 kg	
	F	Kennaway Madelyn	11 MAR 2007	Junior Kata Female	
	F	Kumsi Ameya	03 JUN 2011	U14 Kumite Female -52 kg	
	F	Kumsi Shriya	05 NOC 2009	Cadet Kumite Female -61 kg	
	F	Lavarnway Sydney	30 JUL 2008	Junior Kumite Female -66 kg	
	F	McCammon Brielyn	22 DEC 2006	Junior Kata Female	
	F	McCammon Brielyn	22 DEC 2006	Junior Kumite Female -53 kg	
	F	Nguyen Katelyn	02 OCT 2011	U14 Kumite Female 52+ kg	
F	Nguyen Katelyn	02 OCT 2011	U14 Kata Female		
F	Rashidi Lily	02 MAI 2012	U14 Kata Female		
F	Sanchez Isabella	26 JAN 2010	Cadet Kata Female		
F	Sanchez Isabella	26 JAN 2010	Cadet Kumite Female -47 kg		
F	Shahnaz Lajwerd	11 FEB 2012	U14 Kumite Female -42 kg		
F	Shahnaz Lajwerd	11 FEB 2012	U14 Kata Female		
F	Solis Bella Lan	20 SEP 2007	Junior Kata Female		
F	Thahir Shaza	30 SEP 2003	U21 Kumite Female 68+ kg		
VEN	M	ALEJANDRO LABRADOR	20 MAI 2005	U21 Kumite Male 84+ kg	
	M	De Abreu De Abreu Santiago	04 FEB 2009	Cadet Kumite Male -63 kg	
	M	Gamez Gian	20 AUG 2004	U21 Kumite Male -67 kg	
	M	GRECO GIANLUCA	14 AUG 2008	Cadet Kata Male	
	M	IGNACIO RIOS	05 NOC 2010	U14 Kumite Male +55 kg	
	M	JESUS GARCIA	26 DEC 2010	U14 Kumite Male -50 kg	
	M	LUCAS MUJICA TOMAS	18 AUG 2009	Cadet Kumite Male -63 kg	



Karate1 Youth League - Cancun 2024



ENTRIES BY NOC

As of 11 AUG 2024

NOC Code	Gender	Name	Date Of Birth	Event	Seed
VEN	M	Muga Shamuel	22 JUL 2012	U14 Kata Male	
	M	Sanchez Marquez Joaquin Adolfo	20 JAN 2005	U21 Kumite Male 84+ kg	
	M	VALERO JESUS	10 OCT 2008	Cadet Kumite Male -70 kg	
	F	MARIA GABRIELA ANGULO	23 NOC 2007	Junior Kumite Female -48 kg	
	F	MARIA GABRIELA ANGULO	23 NOC 2007	Junior Kata Female	
	F	OLIGINO DIANA VALENTINA	14 MAI 2007	Junior Kata Female	
	F	REBECA CAMPOS	18 APR 2007	Junior Kumite Female -53 kg	
WAL	M	Preece Nathan	15 AUG 2003	U21 Kumite Male 84+ kg	



Karate1 Youth League - Cancun 2024
ENTRIES BY WEIGHT CATEGORY



Cadet Kata Female
As of 11 AUG 2024

NOC Code	Gender	Name	Seeding
AUT	F	LEHNER TAMARA	
BRA	F	LINS BEATRIZ	
CAN	F	Silva Isabel	
CHI	F	De Luca Agustina Sofia	
CRC	F	CORDERO MARIEL	
CRC	F	LOPEZ SASHA	
CRC	F	MORA ALFARO ALOIS	
CRC	F	RODRIGUEZ MORENO NAHOMY	
CRC	F	VASQUEZ AMY	
DOM	F	GUZMAN VERGARA BELEN	
DOM	F	SALAZAR MONSERRAT	
ECU	F	PAEZ AMELIA	
ESP	F	Castro López Rocío	
FRA	F	VAUCELLE-SPELLE Ninon	
ITA	F	GATTA LINDA	
MEX	F	CATALAN BARRIENTOS ANETTE	
MEX	F	CRUZ CASTILLO PAOLA YAZMIN	
MEX	F	CRUZ LOPEZ FRIDA NAOMI	
MEX	F	HERNANDEZ DIAZ NAOMY	
MEX	F	PLIEGO MALDONADO ESTEFANY QUETZALLI	
MEX	F	QUINTERO AVAS YUBIA MARINA	
MEX	F	RAMOS VAZQUEZ Paloma Judith	
MEX	F	RODRIGUEZ RIOS ZARA ABIGAIL	
MEX	F	TAPIA GONZALEZ ALEXA ELIZABETH	
UKR	F	Afendikova Nika	
USA	F	Andreevski Angelina	
USA	F	Cottingham Emmersyn	
USA	F	Deodhari Sierra	
USA	F	Guaitarilla Kamila	
USA	F	Hong Sophia	
USA	F	Sanchez Isabella	

Cadet Kata Male
As of 11 AUG 2024

NOC Code	Gender	Name	Seeding
BRA	M	LIBORIO GUSTAVO	
CHI	M	Borquez Arancibia Abraham Guillermo	
COL	M	castillo velez matias	
CRC	M	BONILLAS NICOLAS	
CRC	M	JIMENEZ MATIAS	
CRC	M	MEJIA SEBASTIAN	
CRC	M	MURILLO DERECK	
CZE	M	Šťáhlavský David	
DOM	M	BERA BISONO EMIR	



Karate1 Youth League - Cancun 2024
ENTRIES BY WEIGHT CATEGORY



Cadet Kata Male
As of 11 AUG 2024

NOC Code	Gender	Name	Seeding
FRA	M	NGUYEN Toan	
ITA	M	TURCATO GIACOMO FILIPPO	
JAM	M	EVANS RASANDRE VALENTINO	
MEX	M	GARZA VIZCAINO JOSE SANTIAGO	
MEX	M	GONZALEZ RAZO GABRIEL	
MEX	M	GUEVARA VALDEZ DANIEL ALEJANDRO	
MEX	M	JANDA KOBROVA DOMINIK	
MEX	M	RAMOS DEL ANGEL ALFREDO	
MEX	M	RODRIGUEZ VALENCIA LUIS	
PAN	M	JAEN ANTHONY	
POL	M	WAWER WOJCIECH	
SUI	M	Lüthy Corsin Dion	
SUI	M	Mateus Gomes Cristiano	
SUI	M	Mateus Gomes Leonardo	
SWE	M	Erhardt Truls	
SWE	M	Jonasson Jakob	
USA	M	Davila Martin	
USA	M	Isa Cheon	
USA	M	Nguyen Andersen	
USA	M	Nunez Aaron	
USA	M	Salgado Gomez Santiago	
VEN	M	GRECO GIANLUCA	

Cadet Kumite Female -47 kg
As of 11 AUG 2024

NOC Code	Gender	Name	Seeding
AUS	F	CHOI LAWRENCE LUCY	
CRC	F	LOPEZ SASHA	
CRC	F	RODRIGUEZ ISABELLA	
CRC	F	VASQUEZ AMY	
GUA	F	COY AJU DAGNY NAHOMI	
MEX	F	CATALAN BARRIENTOS ANETTE	
MEX	F	ROSALES MATA GEMA SELENIA	
NCA	F	PAULINA RIOS CHAVARRIA	
POR	F	Fernandes Ema Pinéu	
POR	F	Matos Isis	
USA	F	Abu-Rahma Mariam	
USA	F	Sanchez Isabella	

Cadet Kumite Female -54 kg
As of 11 AUG 2024

NOC Code	Gender	Name	Seeding
----------	--------	------	---------



Karate1 Youth League - Cancun 2024
ENTRIES BY WEIGHT CATEGORY



Cadet Kumite Female -54 kg
As of 11 AUG 2024

NOC Code	Gender	Name	Seeding
CAN	F	BEAUDET ALICE	
CHI	F	Contreras Villavicencio Bianca amyra	
COL	F	LONDONO ANDREA VALENTINA	
CRC	F	RODRIGUEZ MORENO NAHOMY	
MEX	F	ESCOBEDO CASTAÑEDA METZTLI	
MEX	F	GARZA VIZCAINO VALENTINA	
MEX	F	QUINTERO AVAS YUBIA MARINA	
MEX	F	VALLEJOS CAAMAL REBECA CATALINA	
POR	F	Gonçalves Leonor	
POR	F	Silva Maria	
POR	F	Varanda Gabriela	
USA	F	Andreevski Angelina	
USA	F	Guaitarilla Kamila	

Cadet Kumite Female -61 kg
As of 11 AUG 2024

NOC Code	Gender	Name	Seeding
CAN	F	RAHMANI AYA	
CHI	F	DONOSO ALMONACID MAITE	
CHI	F	Oyarce Agustina	
CRC	F	MORA ALFARO ALOIS	
CRO	F	MAGDALENIC PAULINA	
DEN	F	Bath Hannah	
ESP	F	SKIBA BIRKELBACH AMELIE YAIZA	
GUA	F	REYES REYNA EMILIA ESTER	
ISL	F	Halldórsdóttir Embla	
MEX	F	DAVILA LOPEZ BARBARA ITZEL	
MEX	F	RAMIREZ MIRANDA FERNANDA MARISOL	
MEX	F	SERRANO JIMENEZ SOPHIA YAHELI	
MEX	F	SOLIS PAT MARIA JOSE	
PER	F	Congona Leon Geraldine Nicole	
USA	F	Kumsi Shriya	

Cadet Kumite Female 61+ kg
As of 11 AUG 2024

NOC Code	Gender	Name	Seeding
AUT	F	KEMETINGER SARAH	
CAN	F	GUERRERO MARIANA	
CHI	F	AGUILERA PEREZ PAULA	
CHI	F	ALVARADO MYHELLEN	
CHI	F	Núñez Daniela	
CHI	F	Sepúlveda Ly Flavia Emilia	



Karate1 Youth League - Cancun 2024
ENTRIES BY WEIGHT CATEGORY



Cadet Kumite Female 61+ kg
As of 11 AUG 2024

NOC Code	Gender	Name	Seeding
CHI	F	Vega ruz Isidora Agustina	
CHI	F	Vera Gazmuri Martina	
CRC	F	CORDERO MARIEL	
GER	F	Gräfe Lotte	
GER	F	Schindler Miley	
MEX	F	HERNANDEZ DIAZ NAOMY	
MEX	F	HERNANDEZ VAZQUEZ DAFNE YARETZI	
MEX	F	JUAREZ MARTINEZ VALERIA LINETT	
MEX	F	Lopez Cerro Ingrid Vanessa	
MEX	F	MENDOZA PEREZ XADANI XIOMARA	
MEX	F	SANCHEZ GRUJIC ANA CAROLINA	
MLT	F	ANTONELLI THYIS	
SCO	F	Ewing Maia	
USA	F	Harling Skyla	
USA	F	Hong Sophia	

Cadet Kumite Male -52 kg
As of 11 AUG 2024

NOC Code	Gender	Name	Seeding
CHI	M	Araya Astengo Joaquín Alonso	
CHI	M	OYARZUN BAHAMONDE ALONSO	
CHI	M	Puga rojas Emilio Alonso	
CHI	M	SANCHEZ BAHAMONDE VICENTE	
ESP	M	PETAGNA LOPEZ PAOLO	
GER	M	Namyslik Felix	
GRE	M	FILIAGKOS ATHANASIOS	
MEX	M	ALMEIDA CHAVEZ MARCO ANTONIO	
MEX	M	GALEOTE TIERRABLANCA ITAN SAID	
MEX	M	GARCIA VALADEZ MATEO	
MEX	M	GUEVARA VALDEZ DANIEL ALEJANDRO	
MEX	M	INIESTA MEZA HECTOR LEONARDO	
MEX	M	SALGADO RUEDA DIEGO	
PER	M	ITURBE PAUCAR THIAGO GAEL	
SUI	M	Lüthy Corsin Dion	
SUI	M	Mateus Gomes Cristiano	
SUI	M	Mateus Gomes Leonardo	
SUI	M	Zecca Lucas	
USA	M	Belfand Paul	
USA	M	Nunez Aaron	
USA	M	Salgado Gomez Santiago	



Karate1 Youth League - Cancun 2024
ENTRIES BY WEIGHT CATEGORY



Cadet Kumite Male -57 kg
As of 11 AUG 2024

NOC Code	Gender	Name	Seeding
CHI	M	Carrera Rubilar Lucian	
CHI	M	LOBOS MACEDO RODRIGO	
COL	M	cifuentes munar giancarlo	
CRC	M	RODESNO DANIEL	
GER	M	Hoerner Paul-Willibald	
JAM	M	EVANS RASANDRE VALENTINO	
MEX	M	BOJORQUEZ BRITO EDWARD ADRIAN	
MEX	M	GARCIA RODRIGUEZ ELIHU EMMANUEL	
MEX	M	PEREZ LOPEZ SANTIAGO	
MEX	M	RANGEL RANGEL GUSTAVO	
MEX	M	SIXTO GARCIA IZEL OCELOTL	
MEX	M	YOSHII MIZUKAMI KAITO DANIEL	
PER	M	Correa Berru Thiago Mathias	
POR	M	Teixeira Pena André Filipe	
PUR	M	Almodovar Marin Diego	
SUI	M	Patricio-Clémont Johan	

Cadet Kumite Male -63 kg
As of 11 AUG 2024

NOC Code	Gender	Name	Seeding
CHI	M	ARRIAGADA PAVEZ INAKI	
CHI	M	Macchiavello Ramírez Piero Alessandro	
CRC	M	MURILLO DERECK	
CRC	M	RIVERA FABRICIO	
CRC	M	RODRIGUEZ SANTIAGO	
GER	M	Niederelz Tim	
GUA	M	FLORES ORTIZ JORGE DAMIAN	
IND	M	Agrawal Abhirraj	
LUX	M	Todorovic Filip	
MEX	M	CERVANTES BANDA SEBASTIAN	
MEX	M	GALAVIZ GALAVIZ JORGE ERUBIEL	
MEX	M	GARCÍA MENESES IGNACIO SALVADOR	
MEX	M	GARZA VIZCAINO JOSE SANTIAGO	
MEX	M	HIGUERA ROMERO Carlos Francisco	
MEX	M	RIVERO ARJONA DAYRON FERNANDO	
PER	M	Arosquipa Quispe Wilbert	
PER	M	LAVADO ROJAS VALENTINO YAEL	
PUR	M	Rivera Rivera Ricardo Jeniel	
USA	M	Farris Logan	
USA	M	WILSON TAVERAS	
VEN	M	De Abreu De Abreu Santiago	
VEN	M	LUCAS MUJICA TOMAS	



Karate1 Youth League - Cancun 2024
ENTRIES BY WEIGHT CATEGORY



Cadet Kumite Male -70 kg
As of 11 AUG 2024

NOC Code	Gender	Name	Seeding
CAN	M	CRONJE JINICHI	
CHI	M	CARRENO OLAVARRIA VICENTE	
CHI	M	MUÑOZ CONTRERAS SEBASTIAN	
COL	M	TORDECILLA FELIPE	
CRC	M	BONILLAS NICOLAS	
CRC	M	JIMENEZ MATIAS	
CRC	M	MEJIA SEBASTIAN	
CRO	M	SLUKIC PETAR	
CZE	M	Šťáhlavský David	
MEX	M	JANDA KOBROVA DOMINIK	
MEX	M	LOPEZ IBARRA EDER RENE	
MEX	M	MOJICA SOTO IAN NICKOLAS	
PAR	M	ALCARAZ LEANDRO	
PER	M	ASALDE MENDOZA PABLO EMMANUEL	
USA	M	Davila Martin	
USA	M	Nguyen Andersen	
VEN	M	VALERO JESUS	

Cadet Kumite Male 70+ kg
As of 11 AUG 2024

NOC Code	Gender	Name	Seeding
CHI	M	Concha Sepulveda Jorge	
CRO	M	SOLTIC ERVIN	
ESP	M	Mazo Marco	
FRA	M	Adjanonhoun Ihsane	
GUA	M	ROLDAN REYNA JOSE MIGUEL	
MEX	M	CAMPOS DESCIDERIO GENCO ANDRE	
MEX	M	PERERA TAMAY CHRISTOPHER JESUS	
MEX	M	PEREZ GUTIERREZ MARCO ANTONIO	
MEX	M	REYNA CANO ORLANDO	
MEX	M	VALERO HERNANDEZ ERIK ALEJANDRO	
SVK	M	Mitrik Richard	
USA	M	Jackson Isaiah	

Junior Kata Female
As of 11 AUG 2024

NOC Code	Gender	Name	Seeding
BRA	F	Collela Yasmin	
CAN	F	Lee Amanda	
COL	F	cardona grajales sara	
CRC	F	CALVO ARIELA	
CRC	F	FERRETO JIMENEZ ANGHELINA	



Karate1 Youth League - Cancun 2024
ENTRIES BY WEIGHT CATEGORY



Junior Kata Female
As of 11 AUG 2024

NOC Code	Gender	Name	Seeding
ESA	F	CERROS ELENA ISABEL	
FRA	F	BUI Mai-Linh	
ITA	F	ederar miriam	
ITA	F	Stangherlin Sofia	
MEX	F	NORMAN PORTILLA KATHERINNE MARYCIELO	
MEX	F	PENA CARRILLO SARA CAMILA	
MEX	F	TERAN GOMEZ AMERICA NAOMI	
POR	F	Marques Rita	
POR	F	OLIVEIRA INÉS	
SVK	F	KADLECAJOVA Viktoria	
USA	F	Jocic Alexa	
USA	F	Kennaway Madelyn	
USA	F	McCammon Brielyn	
USA	F	Solis Bella Lan	
VEN	F	MARIA GABRIELA ANGULO	
VEN	F	OLIGINO DIANA VALENTINA	

Junior Kata Male
As of 11 AUG 2024

NOC Code	Gender	Name	Seeding
AUT	M	WU TIMON	
CAN	M	GRUITIA MATTHEW	
CRC	M	ABELLAN ORLANDO	
CRC	M	MURILLO JOSEPH	
CRC	M	RODRIGUEZ DANIEL	
CRC	M	RODRIGUEZ SEBASTIAN	
DOM	M	BERA BISONO YUSEF	
ECU	M	NARVAEZ MARCO	
IRI	M	Nadimighasroldasht Alireza	
ITA	M	Camanzo Salvatore	
ITA	M	CAPONERA Emanuele	
ITA	M	Di Rubba Luigi	
ITA	M	ederar karim	
ITA	M	Ollagnero Giovanni	
MEX	M	DELGADO SANCHEZ ALFONSO ANDRE	
MEX	M	GARCIA VALADEZ JUAN PABLO	
MEX	M	GARZA VIZCAINO JOSE MARCELO	
MEX	M	LOPEZ MUNOZ ANGEL IVAN	
MEX	M	MACIAS CASTELLANOS JUAN PABLO	
MEX	M	OROZCO GALICIA DANTE ALEJANDRO	
MEX	M	SANTIAGO ZAVALA LUIS EDUARDO	
MEX	M	ZAVALA MERCADO JOSE JUAN	
POR	M	Oliveira Martim	
SUI	M	Schedel Nolan	



Karate1 Youth League - Cancun 2024
ENTRIES BY WEIGHT CATEGORY



Junior Kata Male
As of 11 AUG 2024

NOC Code	Gender	Name	Seeding
USA	M	Nacu Mateo	
USA	M	Ricotti Luca	
USA	M	Santos Lance	
USA	M	Seitz Brayden	
USA	M	Twaddell Xander	

Junior Kumite Female -48 kg
As of 11 AUG 2024

NOC Code	Gender	Name	Seeding
COL	F	Lopez Bernal Maria Del Mar	
COL	F	VALDERRAMA GARCIA VALERIA	
CRO	F	TRSTENJAK AIDA	
DEN	F	Bath Sofia	
GER	F	Drehmann Emily-Chiara	
GUA	F	FLORES ORTIZ MARIA RENEE	
ITA	F	GENTA MICOL	
MEX	F	CABRERA PALOMINO GLORIA YESENIA	
SVK	F	Jalowiczorova Veronika	
SWE	F	Nyman Agnes	
USA	F	Jocic Alexa	
VEN	F	MARIA GABRIELA ANGULO	

Junior Kumite Female -53 kg
As of 11 AUG 2024

NOC Code	Gender	Name	Seeding
CAN	F	Delarosa Kiara	
CHI	F	MELIAN PEREZ ANTONIA	
COL	F	SANCHEZ QUICENO JULIETA	
CRC	F	FERRETO JIMENEZ ANGHELINA	
CRC	F	JIMENEZ MARIA	
ESP	F	VIZCAINO CALVO RUTH	
MEX	F	CONTRERAS MUNOZ ANA KARENI	
MEX	F	NORMAN PORTILLA KATHERINNE MARYCIELO	
MEX	F	REYNA CANO AYLIN YAMILET	
PAR	F	MENCIA JAZMIN	
POL	F	CHLEBOWSKA ANNA	
POL	F	Dopieralska Zuzanna	
USA	F	McCammon Brielyn	
VEN	F	REBECA CAMPOS	



Karate1 Youth League - Cancun 2024
ENTRIES BY WEIGHT CATEGORY



Junior Kumite Female -59 kg
As of 11 AUG 2024

NOC Code	Gender	Name	Seeding
AUT	F	CETIN CEYLIN	
CAN	F	JAWKAR ANUSHKA	
CAN	F	Lee Amanda	
CAN	F	Nijjar Anisha	
CHI	F	CAVICCHIOLI TOLEDO CAMILA	
COL	F	cardona grajales sara	
CRC	F	CALVO ARIELA	
GER	F	Hellen Ili	
GER	F	Mussweiler Mia	
MEX	F	RAMOS ALONSO RENATA	

Junior Kumite Female -66 kg
As of 11 AUG 2024

NOC Code	Gender	Name	Seeding
CHI	F	GARAY SUAZO ISIDORA NOEMI	
CHI	F	PERALTA MARCO DANDARU IGNACIA	
CRC	F	DIAZ SOFIA	
CRO	F	GRGUREVIC LEA	
CRO	F	STRAHIJA LAURA	
DEN	F	Bath Astamaja	
ESP	F	Mazariegos Iglesias Irene	
GUA	F	AGUILAR ALBIZURES MARIA RENEE	
MEX	F	BARROSO RIOS ASHLEY CAMILA	
MEX	F	QUINTERO FLORES GEOMARA	
NED	F	Valk Imane	
POR	F	Cadete Beatriz	
SVK	F	Zeumerova Alexandra	
USA	F	Lavarnway Sydney	

Junior Kumite Female 66+ kg
As of 11 AUG 2024

NOC Code	Gender	Name	Seeding
CAN	F	HOLLYBOW ANIKA	
CHI	F	Puga Rojas Fiorentina Ignacia	
CHI	F	SOTO SEPULVEDA MARTINA IGNACIA	
CRC	F	MORENO AMANDA	
ENG	F	Fry Autumn	
TUN	F	Ettaleb Meriame	



Karate1 Youth League - Cancun 2024
ENTRIES BY WEIGHT CATEGORY



Junior Kumite Male -55 kg
As of 11 AUG 2024

NOC Code	Gender	Name	Seeding
CAN	M	RATHNAYAKE HELITHA	
CHI	M	aguilera Martin	
CHI	M	HERMOSILLA KIRSTEN CRISTOBAL	
CRC	M	PALMA GABRIEL	
ENG	M	Black Joseph	
MEX	M	ARTEAGA ESCALERA RICARDO	
MEX	M	CRUZ ROMERO DANIEL ALEJANDRO	
MEX	M	ESCOBAR CASILLAS PATRICK ALEXANDER	
MEX	M	FREGOSO SUINAGA IKER	
MEX	M	PONCE SANCHEZ FABBIO ALESSANDRO	
MEX	M	Torres García Cesar Emiliano	
PAR	M	FLORENTIN IVAN	
POL	M	OLICHWER NATAN	
POR	M	Fernandes Santiago Pinéu	
PUR	M	Montañes Adorno Arturo Andres	
USA	M	Ochoa Ken	

Junior Kumite Male -61 kg
As of 11 AUG 2024

NOC Code	Gender	Name	Seeding
BEL	M	ROMBEAUX MATT	
BRA	M	Assunção João	
CAN	M	Lee Christopher	
CHI	M	ARAOS SAGREDO MARTIN	
CHI	M	BAHAMONDE MARTIN	
COL	M	BOHORQUEZ CAUSIL JOSE LUIS	
COL	M	TOLEDO SEBASTIAN	
CRC	M	RODRIGUEZ DANIEL	
CRO	M	Mabić Filip	
ECU	M	CHUCHUCA JARED	
ENG	M	Attard Zachary	
ESP	M	MUÑOZ MACIAS LUIS	
GRE	M	KARRAS PETROS	
MEX	M	CORONA VAZQUEZ IVAN ALEJANDRO	
MEX	M	DE LA TORRE ROBLEDO LEONARDO	
MEX	M	DELGADO SANCHEZ ALFONSO ANDRE	
MEX	M	DOMINGUEZ HERNANDEZ ANGEL JULIAN	
MEX	M	GOMEZ GONZALEZ JOSHUA ALI	
MEX	M	REBOLLEDO BRAVO ANDRE SALVADOR	
MEX	M	VELAZQUEZ OSUNA SERGIO EDUARDO	
PAR	M	LOPEZ ENZO	
PER	M	Alvarez Romero Emanuel	
SUI	M	Debost Gaspard	
USA	M	Blunck August	



Karate1 Youth League - Cancun 2024
ENTRIES BY WEIGHT CATEGORY



Junior Kumite Male -61 kg
As of 11 AUG 2024

NOC Code	Gender	Name	Seeding
USA	M	Cruz Bryan	
USA	M	Lopez Zack	
USA	M	Nacu Mateo	
USA	M	Serafimovich Lucas	

Junior Kumite Male -68 kg
As of 11 AUG 2024

NOC Code	Gender	Name	Seeding
ARU	M	BOEKHOUDT NATHAN	
AUT	M	PLATISA PASCAL	
CHI	M	ADRIAZOLA REYES BENJAMIN	
CHI	M	CALISTO GASPAR	
CHI	M	Carvajal Vergara Leonardo José	
CHI	M	Mondaca Rivera Esteban Vicente Andres	
CHI	M	PAVEZ ALONSO	
CRC	M	ABELLAN ORLANDO	
ENG	M	Wilkins Logan	
GER	M	Heller Ben	
GER	M	Thierbach Luca	
ITA	M	CITI JACOPO	
ITA	M	TONIOLO ALVISE	
LAT	M	Ritenieks Olivers	
MEX	M	ANDRADE MARTINEZ OWEN	
MEX	M	BARAJAS ORTEGA EMILIANO	
MEX	M	GARCÍA SANCHEZ DIEGO	
MEX	M	MERINO HERNADEZ JOSUE JACOB	
MEX	M	OROZCO GALICIA DANTE ALEJANDRO	
NCA	M	JULIO ROMERO BERMUDEZ	
PAR	M	SANCHEZ DARDO	
PER	M	Urbina Carranza Gonzalo	
ROU	M	BOGZA GABRIEL	
SUI	M	Lorenz Swan	
USA	M	Corao Luis	
USA	M	River Ariel	

Junior Kumite Male -76 kg
As of 11 AUG 2024

NOC Code	Gender	Name	Seeding
CAN	M	Danesh Daniel	
CHI	M	CAMINADA CATALÁN PHILLIP ANDREE	
CHI	M	PEÑA RENATO	
COL	M	Olmos quintana matheo	



Karate1 Youth League - Cancun 2024
ENTRIES BY WEIGHT CATEGORY



Junior Kumite Male -76 kg
As of 11 AUG 2024

NOC Code	Gender	Name	Seeding
CRC	M	ARAYA DANIEL	
CRO	M	STRAHIJA SVEN	
ESP	M	Leal Moreno Iker	
GER	M	Knopp Phil	
GER	M	Zuniga Späthe Robin Mateo	
GUA	M	MORALES SERRANO GERSHON ADIR	
MEX	M	MONTANO MORALES EDUARDO	
MEX	M	ORTEGA DESCIDERIO ANGEL JOSUE	
MEX	M	SANCHEZ MONTENEGRO RUBEN	
MEX	M	SANDOVAL SANDOVAL JOSE ANTONIO	
MEX	M	TAPIA SOLANO NICOLAS WINAJEL	
MEX	M	VILLAFANA VARGAS ALAN GERARDO	
MEX	M	ZAVALA MERCADO JOSE JUAN	
NCA	M	MOLINA GARAY MATHEUS	
PUR	M	Molina Ortiz Oscar	
USA	M	Merrell Grayson	
USA	M	Wood Landen	

Junior Kumite Male 76+ kg
As of 11 AUG 2024

NOC Code	Gender	Name	Seeding
AUT	M	SELIMOVIC ARMIN	
CHI	M	Gálvez Tamayo Vicente Cristóbal	
CRC	M	CARDENAS EDUARDO	
CRO	M	GONDI NIKOLA	
ESP	M	MIRESAN SECHEI CRISTIAN ALEXANDRU	
ESP	M	Ruiz Ruiz José Luis	
HON	M	Torres Santos Henry Samael	
MEX	M	GARZA CHAVARRIA FRANCISCO DEMIAN	
MEX	M	MORENO CANO JOSE DE JESUS	
MEX	M	MORENO FLORES GUILLERMO ZABDIEL	
MEX	M	PUEBLA GODOY GABRIEL TZAM	
MEX	M	RODRIGUEZ PEREZ JAVIER ALEJANDRO	
MEX	M	SANTIAGO ZAVALA LUIS EDUARDO	
PAR	M	SANCHEZ CAMILO	
USA	M	Molinero Michael	

U14 Kata Female
As of 11 AUG 2024

NOC Code	Gender	Name	Seeding
AUS	F	WIBOWO REBECCA	
CRC	F	SOLOMON ALANA	



Karate1 Youth League - Cancun 2024
ENTRIES BY WEIGHT CATEGORY



U14 Kata Female
As of 11 AUG 2024

NOC Code	Gender	Name	Seeding
MEX	F	GARCIA ARELLANO NAOMI ALOTL	
MEX	F	GARZA VIZCAINO MARIA VICTORIA	
MEX	F	HERNANDEZ QUIROZ ROBERTA	
MEX	F	PATRICIO GAYOSSO REGINA	
MEX	F	Perez Gonzalez Nahomi Dayana	
SUI	F	Schedel Kaena	
USA	F	Andreevski Kalina	
USA	F	Nguyen Katelyn	
USA	F	Rashidi Lily	
USA	F	Shahnaz Lajwerd	

U14 Kata Male
As of 11 AUG 2024

NOC Code	Gender	Name	Seeding
AUT	M	ZADINA EMIL	
BRA	M	Miranda Vaz Murillo	
CAN	M	Concepcion Dean	
CAN	M	Gunja Karim	
CAN	M	HOBSON CHASE	
CHI	M	Sotomayor Villaroel Benjamin	
CRC	M	CORRALES NATAN	
CRC	M	GONZALES MOISES	
CRC	M	JIMENEZ NICOLAS	
DOM	M	CARBALLO JOSE	
DOM	M	DISLA JOSE	
DOM	M	SANCHEZ FIALLO JOSE GUILLERMO	
ESP	M	Castro López Braulio	
JAM	M	EVANS VALENTINO RASANDRE	
MEX	M	BAULCH LECA AIZEN	
MEX	M	BOJORQUEZ ARCE BRANDON VLADIMIR	
MEX	M	DELGADO SANCHEZ SAUL ALEJANDRO	
MEX	M	ROBLES CASTRO CARLOS KALEB	
MEX	M	SANTIAGO ZAVALA AXEL MANUEL	
SVK	M	VERCIMAK MARTIN	
USA	M	BARNABEI MASSIMO	
USA	M	Bonetti Akiau Luigi	
USA	M	Sanchez Luis	
USA	M	Sattanathan Sivanandh	
VEN	M	Muga Shamuel	



Karate1 Youth League - Cancun 2024
ENTRIES BY WEIGHT CATEGORY



U14 Kumite Female -42 kg
As of 11 AUG 2024

NOC Code	Gender	Name	Seeding
CAN	F	Gill Sereya	
CHI	F	Valderrama Alvarez Fernanda Amaral	
COL	F	PEREZ SALAMANCA NATALIA	
FRA	F	Ben Rabeh Aliya	
MEX	F	ALCAZAR CAMACHO Francés hannaely	
MEX	F	GARZA VIZCAINO MARIA VICTORIA	
USA	F	Andreevski Kalina	
USA	F	Shahnaz Lajwerd	

U14 Kumite Female -47 kg
As of 11 AUG 2024

NOC Code	Gender	Name	Seeding
CAN	F	Jawkar Aarya	
CAN	F	RATHNAYAKE MUTHULI	
CHI	F	CAVICCHIOLI TOLEDO CONSTANZA	
CHI	F	Soto Catalina	
CRC	F	SOLOMON ALANA	
GER	F	Olschewski Hanna	
MEX	F	HERNANDEZ QUIROZ ROBERTA	
MLT	F	MADDEN LEIA-SUMMER	
PER	F	Vásquez Peña Astrid	
USA	F	Balint Elina	

U14 Kumite Female -52 kg
As of 11 AUG 2024

NOC Code	Gender	Name	Seeding
CHI	F	VEGA BUSTAMANTE AMANDA	
ESP	F	Mazariegos Iglesias Esther	
ESP	F	MELGAR POSTIGO JULIA MARIA	
GER	F	Förster Alexia	
MEX	F	HERNANDEZ YANEZ FRIDA NICOLE	
MEX	F	RIVERA RODRIGUEZ JADE GETSEMANI	
PER	F	La Serna Hilario Grecia Beatriz	
PER	F	Yuffra Mirez Luana María	
USA	F	Arcalean Mihaela	
USA	F	Kumsi Ameya	

U14 Kumite Female 52+ kg
As of 11 AUG 2024

NOC Code	Gender	Name	Seeding
----------	--------	------	---------



Karate1 Youth League - Cancun 2024
ENTRIES BY WEIGHT CATEGORY



U14 Kumite Female 52+ kg
As of 11 AUG 2024

NOC Code	Gender	Name	Seeding
BIH	F	Omanović Lamija	
CHI	F	ANTIPA GONZALEZ MAILEN	
CHI	F	AROS REBOLLEDO EMILIA	
ENG	F	HANDLEY SKYLA	
GER	F	Hoerner Frieda	
MEX	F	FRIAS CABRAL MELINA	
MEX	F	GARCIA ARELLANO NAOMI ALOTL	
MEX	F	RUIZ PEREZ MARIA FERNANDA	
PAR	F	BENITEZ LUCIA	
USA	F	Nguyen Katelyn	

U14 Kumite Male +55 kg
As of 11 AUG 2024

NOC Code	Gender	Name	Seeding
CAN	M	SAJADI PARSA	
CHI	M	BUSTAMANTE ALVARADO LEANDRO	
CHI	M	Campusano Matías	
CHI	M	HERNANDEZ NAVARRO MATHIAS	
CHI	M	SALAS HERNANDEZ DILAN	
ESP	M	Gomez Jimenez Francisco Javier	
GER	M	Azadi Bijan	
GER	M	Gräfe Lukas	
GER	M	Pagin Lukasz	
MEX	M	GARCIA ROCHA JOSE LUIS	
MEX	M	OLIVAS ROMERO PABLO ANTONIO	
PER	M	Honorio Velasco Alvaro Manuel	
USA	M	OUSMANE NIANG	
VEN	M	IGNACIO RIOS	

U14 Kumite Male -40 kg
As of 11 AUG 2024

NOC Code	Gender	Name	Seeding
CAN	M	HOBSON CHASE	
CHI	M	MARTINEZ SAGREDO LEON	
CRC	M	GONZALES MOISES	
MEX	M	ALCAZAR RUIZ FRANCISCO JAVIER YASYDT	
MEX	M	AMBROSIO PENA ROGELIO ANTONIO	
MEX	M	BOJORQUEZ ARCE BRANDON VLADIMIR	
MEX	M	PEREZ KASUGA MARIO ALBERTO SHINJI	
MEX	M	ROBLES CASTRO CARLOS KALEB	
PER	M	Lavado Rojas Giordano Ghael	
USA	M	BARNABEI MASSIMO	



Karate1 Youth League - Cancun 2024
ENTRIES BY WEIGHT CATEGORY



U14 Kumite Male -40 kg
As of 11 AUG 2024

NOC Code	Gender	Name	Seeding
USA	M	Shaikh Aariz	
USA	M	Shaikh Ryaz	

U14 Kumite Male -45 kg
As of 11 AUG 2024

NOC Code	Gender	Name	Seeding
BRA	M	Miranda Vaz Murillo	
CAN	M	Palanisamy Arun Adit	
CHI	M	BAHAMONDE AGUSTIN	
CHI	M	Navarrete Sebastián	
CHI	M	Sotomayor Villaroel Benjamin	
GER	M	Grünelt Oliver	
JAM	M	EVANS VALENTINO RASANDRE	
MEX	M	CABALLERO AQUINO LUIS ERNESTO	
MEX	M	Cervantes Vazquez Vishwambar Jan	
MEX	M	CETINA VALLEJOS NOEL ABISAI	
MEX	M	D FLON VASQUEZ KAILASH TARIK	
MEX	M	SANTIAGO ZAVALA AXEL MANUEL	
USA	M	Bonetti Akiau Luigi	
USA	M	Sanchez Luis	
USA	M	Sattanathan Sivanandh	
USA	M	SEKOU BEN STEPHAN TIMITE	

U14 Kumite Male -50 kg
As of 11 AUG 2024

NOC Code	Gender	Name	Seeding
CAN	M	Singh Evan	
CHI	M	CONTRERAS ORTIZ LUCAS	
CHI	M	MIRALLES PINEDA MATEO	
CRC	M	CORRALES NATAN	
CRC	M	JIMENEZ NICOLAS	
CRC	M	VILLALOBOS JUAN CAMILO	
ITA	M	Ferraris Giacomo	
MEX	M	GIL GONZALEZ PATRICIO	
MEX	M	MERCADO DE ANDA Abraham	
MEX	M	OROZCO TORRES JOSE HUMBERTO	
NCA	M	MONTEALEGRE VILLELA OSCAR GUSTAVO	
PAR	M	MARTINEZ ALBARO	
VEN	M	JESUS GARCIA	



Karate1 Youth League - Cancun 2024
ENTRIES BY WEIGHT CATEGORY



U14 Kumite Male -55 kg
As of 11 AUG 2024

NOC Code	Gender	Name	Seeding
ESP	M	BENITEZ MORENO FRANCISCO	
MEX	M	ACOSTA PARICIO TOMAS	
MEX	M	CAAMAL PUC PEDRO RAFAEL	
MEX	M	CHAVEZ RAMIREZ Gerardo Gabriel	
MEX	M	DELGADO SANCHEZ SAUL ALEJANDRO	
MEX	M	HERNANDEZ JIMENEZ JULIAN	
MEX	M	PEREZ MENDEZ FRANCISCO DANIEL	
MEX	M	VELAZQUEZ OSUNA OLIVER LEONARDO	
PER	M	Ccoillo Ferrante Adriano Tadeo	

U21 Kata Female
As of 11 AUG 2024

NOC Code	Gender	Name	Seeding
BRA	F	BISSOLI FERRI KUSTER AMANDA	
BRA	F	Cardoso Letícia de Souza	
CAN	F	CARTER BROOKLYN	
CAN	F	Kudsi Masa	
CHI	F	GALLO ARAYA ISIDORA	
CHI	F	SALINAS ISIDORA CAROLINA	
COL	F	castaño rojo leidy daniela	
CRC	F	RUIZ CAMILA	
ENG	F	Williams Danni	
ITA	F	Tagliaferro Chiara	
MEX	F	Dena Alvarez Joana María	
MEX	F	GARCIA PACHECO REGINA ESTELA	
MEX	F	MARTINEZ ZAPATA ANA YURIDIA	
MEX	F	QUINTERO AVAS CIELO	
MEX	F	VALDES LEYVA RAQUEL	
PER	F	Valdivia Monzon Alexandra Sofia	
POR	F	Cardoso Maria	
POR	F	Martins Rita	
SUI	F	Tschanz Olivia	

U21 Kata Male
As of 11 AUG 2024

NOC Code	Gender	Name	Seeding
CAN	M	Darveau Olivier	
CHI	M	Mesina Fuentes Kevin Alexis	
CHI	M	URDANETA VALENCIA ALBERTO	
COL	M	Medina David	
CZE	M	Šťáhlavský Ondřej	
ECU	M	PAEZ JOAQUIN	



Karate1 Youth League - Cancun 2024
ENTRIES BY WEIGHT CATEGORY



U21 Kata Male
As of 11 AUG 2024

NOC Code	Gender	Name	Seeding
ENG	M	Barnes Dylan	
ENG	M	McDade Chad	
FRA	M	BOMPAS JANHAEL	
FRA	M	HOFFMANN LUCAS	
GUA	M	CALDERON FERNANDO	
GUA	M	Castillo Mazariego Jose Manuel	
GUA	M	Diego Noriega Francisco David	
HKG	M	KWOK HO HIM	
ITA	M	MATACCHIONI LUIGI	
MEX	M	CASTILLO RAMOS RODRIGO	
MEX	M	FUNES ANAYA PABLO JESUS	
MEX	M	LEDESMA LUNA ISAAC RAFAEL	
MEX	M	ROJAS SANCHEZ ARATH SAID	
MEX	M	Vega Batiz Carlos Santiago	
PER	M	HIGUCHI KEN	
PER	M	Mejia Ignacio	
POR	M	Matos Pedro	
SUI	M	PETRONE Leandro	
SUI	M	Schedel Keni	
USA	M	Adi David	
USA	M	Corbin Joshua	
USA	M	Quackenbush Eric	

U21 Kumite Female -50 kg
As of 11 AUG 2024

NOC Code	Gender	Name	Seeding
BOL	F	LUNA PAOLA	
CHI	F	ECHEVERRIA VEGA BELÉN ANTONIA ALEXANDRA	
CHI	F	LEIVA GAETE MAIRA	
ESA	F	ORANTES MAGANA SOFIA ALEJANDRA	
MEX	F	CARRILLO URDIALES CINTHIA RUBI	
MEX	F	SALINAS HERNANDEZ EMILIA	
NED	F	YALCIN Samina	

U21 Kumite Female -55 kg
As of 11 AUG 2024

NOC Code	Gender	Name	Seeding
BEL	F	Ejja Iman	
CAN	F	REGLAR EMILY	
CHI	F	flores cabrera francisca	
CHI	F	GATICA MORALES BELEN	
CHI	F	GODOY MAGDALENA	



Karate1 Youth League - Cancun 2024
ENTRIES BY WEIGHT CATEGORY



U21 Kumite Female -55 kg
As of 11 AUG 2024

NOC Code	Gender	Name	Seeding
COL	F	GOMEZ BUITRAGO MARIA JOSE	
ESA	F	FLORES RAMOS HAZEL SAMEIDY	
MEX	F	GARCIA PACHECO REGINA ESTELA	
MEX	F	HERRERA AYALA ANA CAROLINA	
MEX	F	NIETO FLORES IDALIA KARIME	

U21 Kumite Female -61 kg
As of 11 AUG 2024

NOC Code	Gender	Name	Seeding
CAN	F	LAWRANCE SOPHIE	
CHI	F	Vergara Ramírez Martina Isidora	
COL	F	AGUDELO MARIN MARIA ALEJANDRA	
COL	F	gomez betancur ana maria	
COL	F	MAYA NAYELIS	
CRO	F	CACKO MIA	
MEX	F	LOPEZ SERRATOS KATIA DANIELA	
MEX	F	SAAVEDRA AGUIRRE VALERIA	
POL	F	Criou Eva	

U21 Kumite Female -68 kg
As of 11 AUG 2024

NOC Code	Gender	Name	Seeding
CHI	F	PERALTA MARCO José Ignacia	
GUA	F	PALENCIA LUISA	
MEX	F	MENDEZ MAYEN ALONDRA ELIZABETH	
MEX	F	QUINTERO AVAS CIELO	
MEX	F	SORIA ESQUIVEL ANA SOFIA	
MEX	F	VALDES LEYVA RAQUEL	

U21 Kumite Female 68+ kg
As of 11 AUG 2024

NOC Code	Gender	Name	Seeding
AUT	F	SCHUETZE EMMA	
COL	F	GUARIN SOFIA	
ENG	F	Allsopp Amber	
PER	F	Honorio Velasco Doris Fabiana	
SLO	F	Muzik Taša Mau	
USA	F	Jennings Destiny	
USA	F	Thahir Shaza	



Karate1 Youth League - Cancun 2024
ENTRIES BY WEIGHT CATEGORY



U21 Kumite Male -60 kg
As of 11 AUG 2024

NOC Code	Gender	Name	Seeding
ARG	M	GALLARDO JUAN IGNACIO	
CHI	M	CUEVAS NUNEZ JAVIER	
COL	M	MAINGUEZ NOGUERA JUAN CAMILO	
COL	M	PASTRANA SANTANA JORDI JOSE	
CRC	M	JARA JOSHUA	
GUA	M	Castillo Mazariego Jose Manuel	
MEX	M	BAUTISTA ESTEBAN	
MEX	M	CASTILLO CORTES ADRIAN	
PER	M	TUCTO SANCHEZ JUAN DIEGO	
POR	M	Oliveira Gustavo	
ROU	M	GOATA MATEI	
USA	M	Cruz Kevin	
USA	M	Dolinyan Davit	
USA	M	Dorta Janco	
USA	M	Dorta Jean	

U21 Kumite Male -67 kg
As of 11 AUG 2024

NOC Code	Gender	Name	Seeding
ARU	M	PRADA SUNCO KEVEN	
BEL	M	Ejja Amine	
CHI	M	ARCE ZUNIGA BASTIAN	
CHI	M	Jara Muñoz Maximiliano Ignacio	
COL	M	BAENA TAMAYO MATEO	
COL	M	Olmos quintana Juan David	
DEN	M	Linaa Mathias Bech	
ENG	M	Flounders Joseph	
ENG	M	Monk Luke	
GUA	M	CHACON MAZARIEGOS DIEGO ERNESTO	
HKG	M	KWOK HO HIM	
MEX	M	Vega Batiz Carlos Santiago	
MEX	M	VIDEGARAY PEREZ PATRICIO	
MEX	M	YOSHII MIZUKAMI HIROTO JAVIER	
PAR	M	RINCK DIETER	
POL	M	Dziuda Dominik	
POR	M	Alves Rafael	
POR	M	Gonçalves Guilherme	
SUI	M	Torres Steven	
USA	M	Solis Mateo	
VEN	M	Gamez Gian	



Karate1 Youth League - Cancun 2024
ENTRIES BY WEIGHT CATEGORY



U21 Kumite Male -75 kg
As of 11 AUG 2024

NOC Code	Gender	Name	Seeding
BRA	M	Gonçalves Negri Pedro	
COL	M	gomez tobon jose david	
COL	M	MONTOYA CARDOZO CESAR STIVEN	
CZE	M	Šťáhlavský Ondřej	
MEX	M	CURIEL ALARCON SANTIAGO	
MEX	M	GUTIERREZ MADRIGAL KAROL DANIEL	
MEX	M	LEDESMA LUNA ISAAC RAFAEL	
MEX	M	YOSHII MIZUKAMI HAYATO FRANCISCO	
PER	M	BACHOIR VEGA ANDRE LOUIS	
POR	M	Fernandes Bernardo Pineu	
POR	M	Inacio Diogo	
USA	M	Corbin Joshua	
USA	M	Kasturi Sahil	

U21 Kumite Male -84 kg
As of 11 AUG 2024

NOC Code	Gender	Name	Seeding
CHI	M	PONCE SOTO HECTOR	
COL	M	ospina soscue santiago	
ENG	M	Walker Ollie	
EST	M	Mets Mihkel	
GUA	M	GARCIA MONTT JOSE EMILIANO	
ISL	M	Halldórsson Hugi	
MEX	M	CARAVANTES MONTOYA ARIF ENRIQUE	
MEX	M	GARCIA GARCIA JESUS FRANCISCO	
USA	M	Buka Yan	
USA	M	Saunders-Long Tristan	

U21 Kumite Male 84+ kg
As of 11 AUG 2024

NOC Code	Gender	Name	Seeding
CAN	M	DE LANDA ZISKROUT ISAAC	
COL	M	GAMBOA NICOLAS	
COL	M	hernandez meneses yoseph ferney	
MEX	M	AVILA IBARRA SALVADOR	
MEX	M	PADILLA GARCIA ISAAC GAEL	
MEX	M	rodriguez gonzalez miguel angel	
MEX	M	VELASCO MARQUEZ ALBERTO	
PAR	M	BRITOS IVAN	
USA	M	White Jared	
VEN	M	ALEJANDRO LABRADOR	
VEN	M	Sanchez Marquez Joaquin Adolfo	



Karate1 Youth League - Cancun 2024
ENTRIES BY WEIGHT CATEGORY



U21 Kumite Male 84+ kg
As of 11 AUG 2024

NOC Code	Gender	Name	Seeding
WAL	M	Preece Nathan	



Karate1 Youth League - Cancun 2024



Statistics

Participating Countries: 55

	Competitors	Entries
Female	247	277
Male	399	442
Total	646	719

Entries per Category	Entries	Teams
Cadet Kata Female	31	-
Cadet Kata Male	31	-
Cadet Kumite Female -47 kg	12	-
Cadet Kumite Female -54 kg	13	-
Cadet Kumite Female -61 kg	15	-
Cadet Kumite Female 61+ kg	21	-
Cadet Kumite Male -52 kg	21	-
Cadet Kumite Male -57 kg	16	-
Cadet Kumite Male -63 kg	22	-
Cadet Kumite Male -70 kg	17	-
Cadet Kumite Male 70+ kg	12	-
Junior Kata Female	21	-
Junior Kata Male	29	-
Junior Kumite Female -48 kg	12	-
Junior Kumite Female -53 kg	14	-
Junior Kumite Female -59 kg	10	-
Junior Kumite Female -66 kg	14	-
Junior Kumite Female 66+ kg	6	-
Junior Kumite Male -55 kg	16	-
Junior Kumite Male -61 kg	28	-
Junior Kumite Male -68 kg	26	-
Junior Kumite Male -76 kg	21	-
Junior Kumite Male 76+ kg	15	-
U14 Kata Female	12	-
U14 Kata Male	25	-
U14 Kumite Female -42 kg	8	-
U14 Kumite Female -47 kg	10	-
U14 Kumite Female -52 kg	10	-
U14 Kumite Female 52+ kg	10	-
U14 Kumite Male +55 kg	14	-
U14 Kumite Male -40 kg	12	-



Karate1 Youth League - Cancun 2024



Statistics

U14 Kumite Male -45 kg	16	-
U14 Kumite Male -50 kg	13	-
U14 Kumite Male -55 kg	9	-
U21 Kata Female	19	-
U21 Kata Male	28	-
U21 Kumite Female -50 kg	7	-
U21 Kumite Female -55 kg	10	-
U21 Kumite Female -61 kg	9	-
U21 Kumite Female -68 kg	6	-
U21 Kumite Female 68+ kg	7	-
U21 Kumite Male -60 kg	15	-
U21 Kumite Male -67 kg	21	-
U21 Kumite Male -75 kg	13	-
U21 Kumite Male -84 kg	10	-
U21 Kumite Male 84+ kg	12	-
Totals:	719	0

CADET KATA FEMALE



Karate1 Youth League - Cancun 2024
ENTRIES BY WEIGHT CATEGORY



Cadet Kata Female
As of 11 AUG 2024

NOC Code	Gender	Name	Seeding
AUT	F	LEHNER TAMARA	
BRA	F	LINS BEATRIZ	
CAN	F	Silva Isabel	
CHI	F	De Luca Agustina Sofía	
CRC	F	CORDERO MARIEL	
CRC	F	LOPEZ SASHA	
CRC	F	MORA ALFARO ALOIS	
CRC	F	RODRIGUEZ MORENO NAHOMY	
CRC	F	VASQUEZ AMY	
DOM	F	GUZMAN VERGARA BELEN	
DOM	F	SALAZAR MONSERRAT	
ECU	F	PAEZ AMELIA	
ESP	F	Castro López Rocío	
FRA	F	VAUCELLE-SPELLE Ninon	
ITA	F	GATTA LINDA	
MEX	F	CATALAN BARRIENTOS ANETTE	
MEX	F	CRUZ CASTILLO PAOLA YAZMIN	
MEX	F	CRUZ LOPEZ FRIDA NAOMI	
MEX	F	HERNANDEZ DIAZ NAOMY	
MEX	F	PLIEGO MALDONADO ESTEFANY QUETZALLI	
MEX	F	QUINTERO AVAS YUBIA MARINA	
MEX	F	RAMOS VAZQUEZ Paloma Judith	
MEX	F	RODRIGUEZ RIOS ZARA ABIGAIL	
MEX	F	TAPIA GONZALEZ ALEXA ELIZABETH	
UKR	F	Afendikova Nika	
USA	F	Andreevski Angelina	
USA	F	Cottingham Emmersyn	
USA	F	Deodhari Sierra	
USA	F	Guaitarilla Kamila	
USA	F	Hong Sophia	
USA	F	Sanchez Isabella	

Cadet Kata Female

Karate1 Youth League - Cancun 2024, Iberostar Playa Paraíso Convention Center, Avenida del Sol Km 309, Playa Paraiso, 77710 Riviera Maya, MEX

2024-08-10

Tatami

1 09:00

Pool

1/2

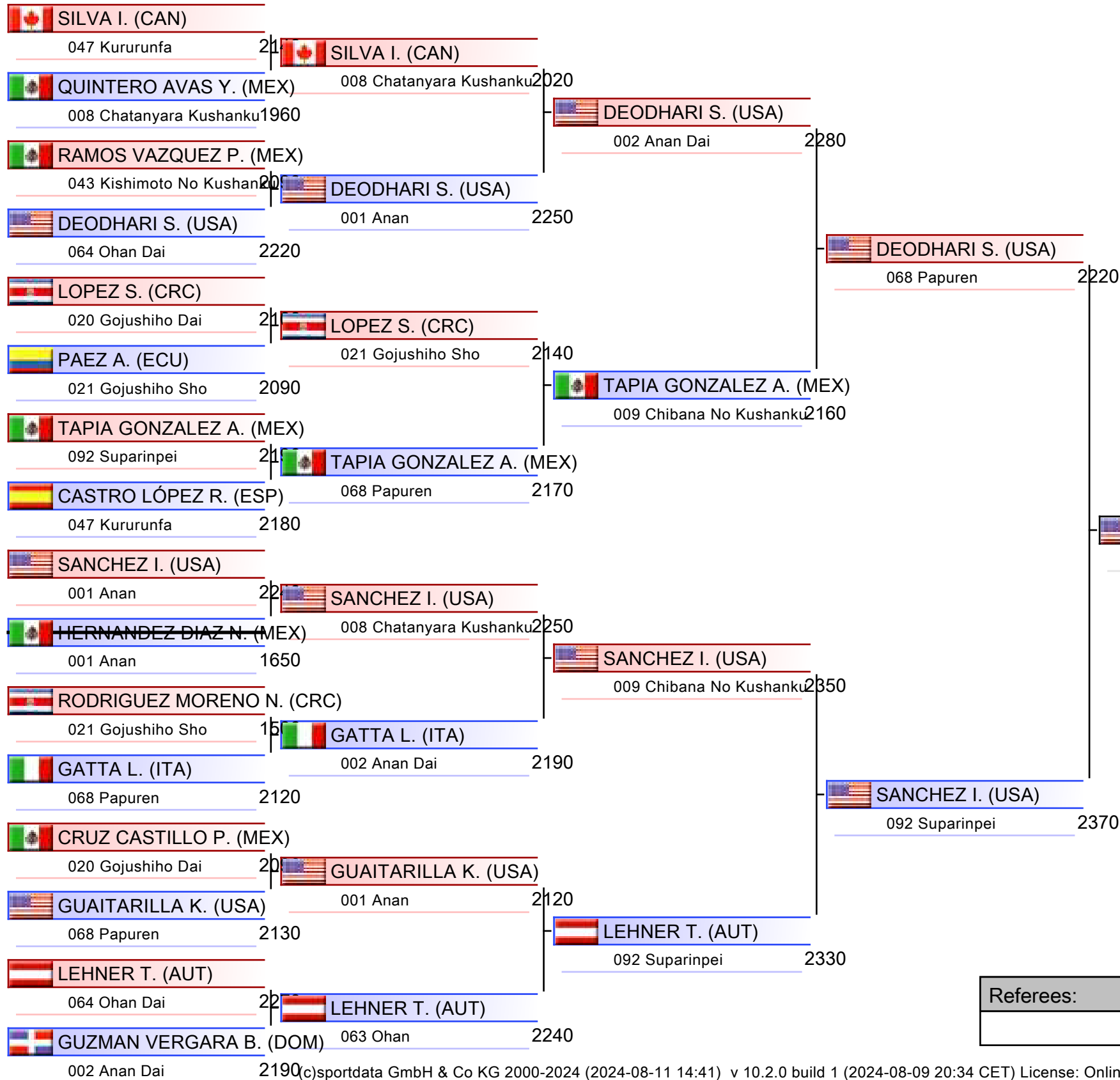

1. VAUCELLE-SPELLE NINON (FRA)
2. SANCHEZ ISABELLA (USA)
3. COTTINGHAM EMMERSYN (USA)
3. LEHNER TAMARA (AUT)
5. PLIEGO MALDONADO ESTEFANY QUETZALLI (CHI)
5. DEODHARI SIERRA (USA)
7. DE LUCA AGUSTINA SOFÍA (CHI)
7. GATTA LINDA (ITA)

Referees:			

Cadet Kata Female

Karate1 Youth League - Cancun 2024, Iberostar Playa Paraíso Convention Center, Avenida del Sol Km 309, Playa Paraiso, 77710 Riviera Maya, MEX

2024-08-10

Tatami

2 09:00

Pool

2/2

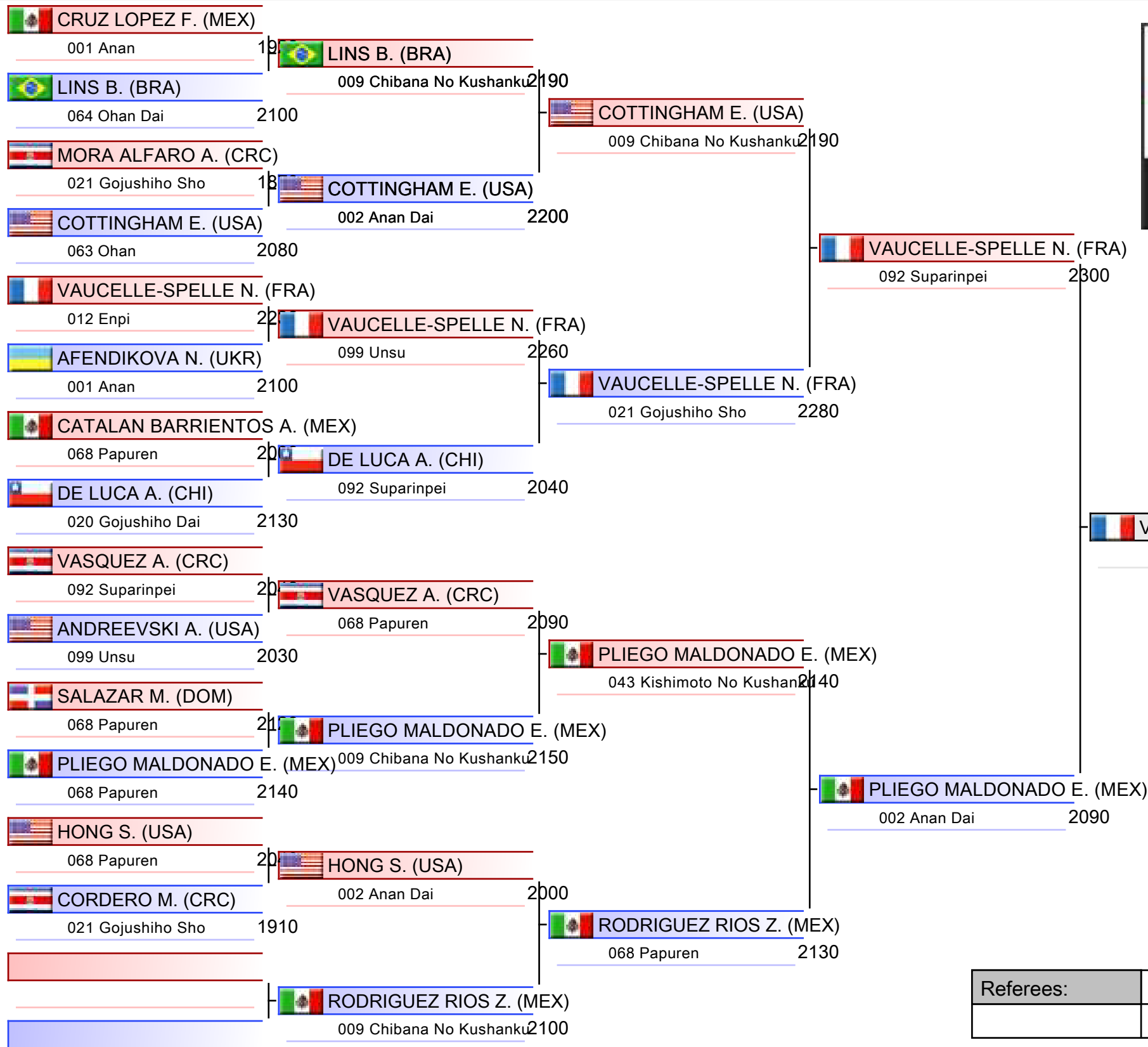

- | |
|--|
| 1. VAUCELLE-SPELLE NINON (FRA) |
| 2. SANCHEZ ISABELLA (USA) |
| 3. COTTINGHAM EMMERSYN (USA) |
| 3. LEHNER TAMARA (AUT) |
| 5. PLIEGO MALDONADO ESTEFANY QUETZALLI (MEX) |
| 5. DEODHARI SIERRA (USA) |
| 7. DE LUCA AGUSTINA SOFÍA (CHI) |
| 7. GATTA LINDA (ITA) |

Referees:			

Pool winner-Cadet Kata Female

Karate1 Youth League - Cancun 2024, Iberostar Playa Paraíso Convention Center, Avenida del Sol Km 309, Playa Paraiso, 77710 Riviera Maya, MEX

Tatami

Pool

1/1

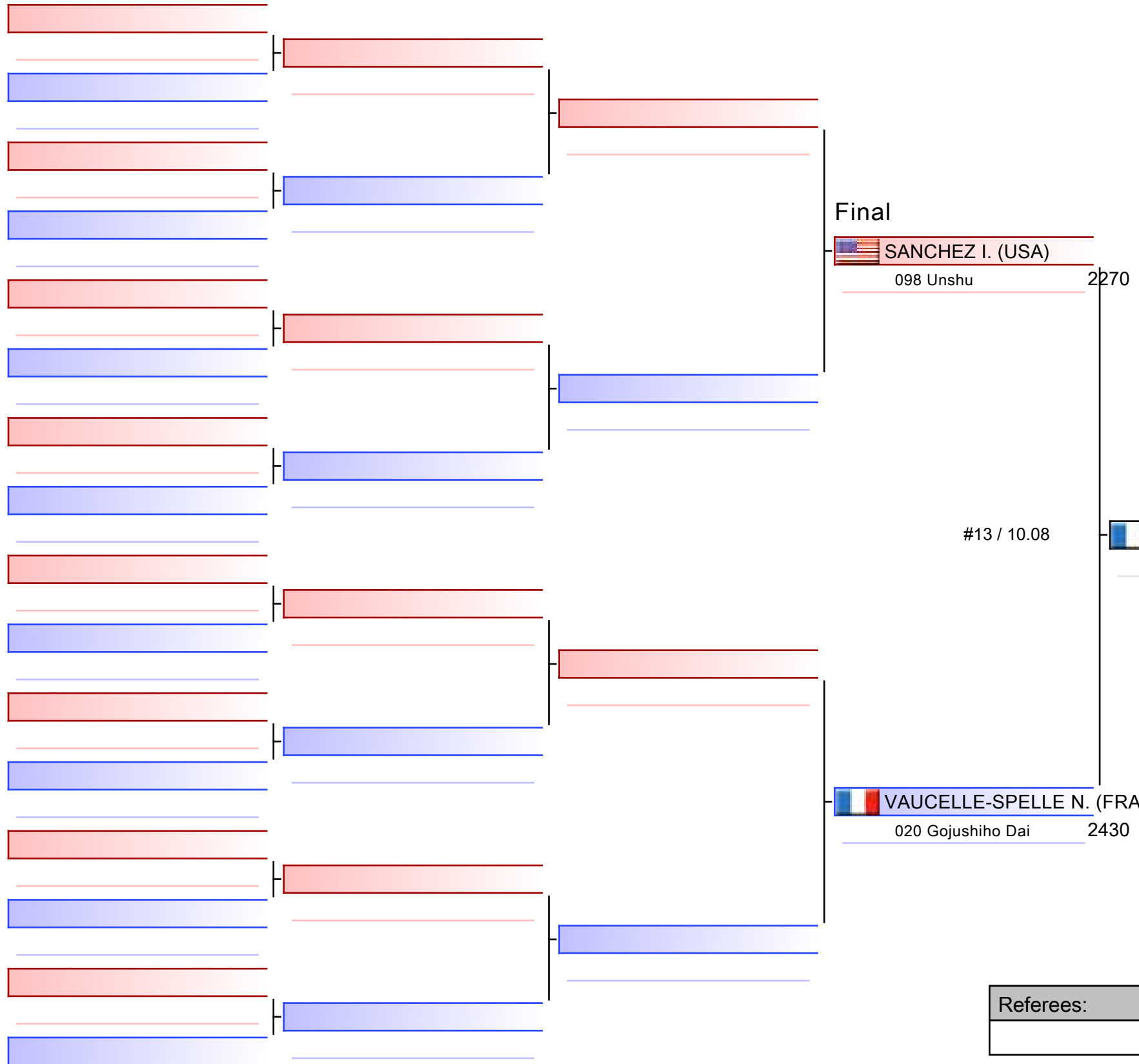

1. VAUCELLE-SPELLE NINON (FRA)
2. SANCHEZ ISABELLA (USA)
3. COTTINGHAM EMMERSYN (USA)
3. LEHNER TAMARA (AUT)
5. PLIEGO MALDONADO ESTEFANY QUETZALLI (MEX)
5. DEODHARI SIERRA (USA)
7. DE LUCA AGUSTINA SOFÍA (CHI)
7. GATTA LINDA (ITA)

Referees:			

Cadet Kata Female

Karate1 Youth League - Cancun 2024

2024-08-10

Tatami
1 11:00

Pool
1

(c)sportdata GmbH & Co KG 2000-2024 (2024-08-11 14:41) v 10.2.0 build 1 (2024-08-09 20:34 CET) License: Online_Event_ID-875_Karate1YouthLeagueCancun2024 (expire 2024-08-25)

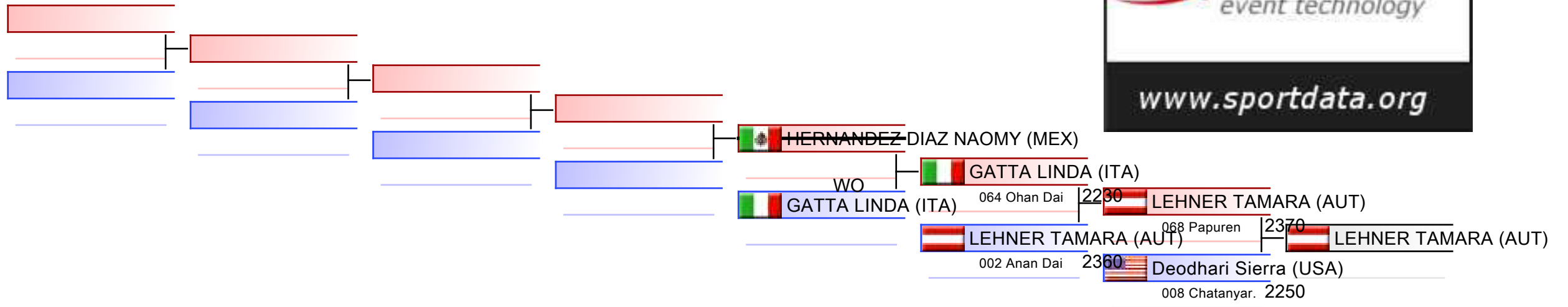

REPECHAGE: (1)

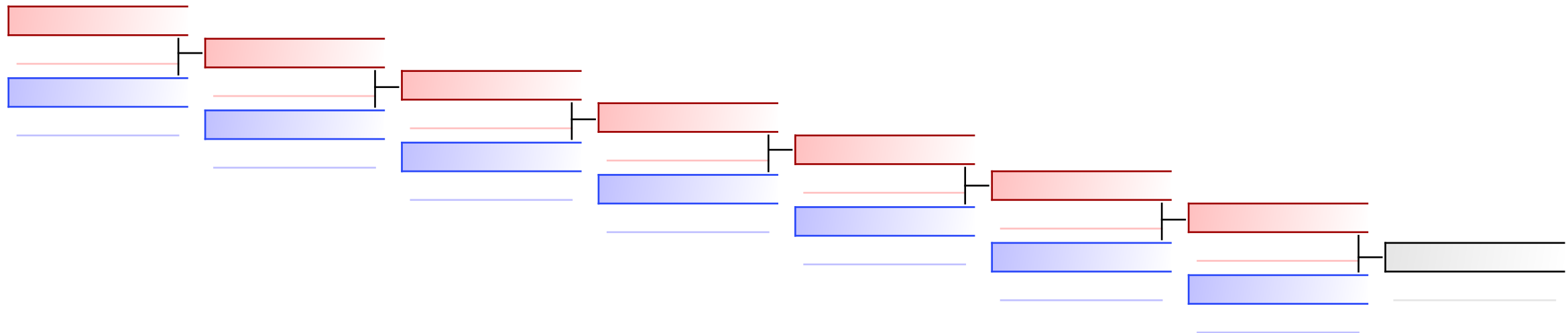

Referees:							
-----------	--	--	--	--	--	--	--

Cadet Kata Female

Karate1 Youth League - Cancun 2024

2024-08-10

Tatami
2 10:55

Pool
2

(c)sportdata GmbH & Co KG 2000-2024 (2024-08-11 14:41) v 10.2.0 build 1 (2024-08-09 20:34 CET) License: Online_Event_ID-875_Karate1YouthLeagueCancun2024 (expire 2024-08-25)

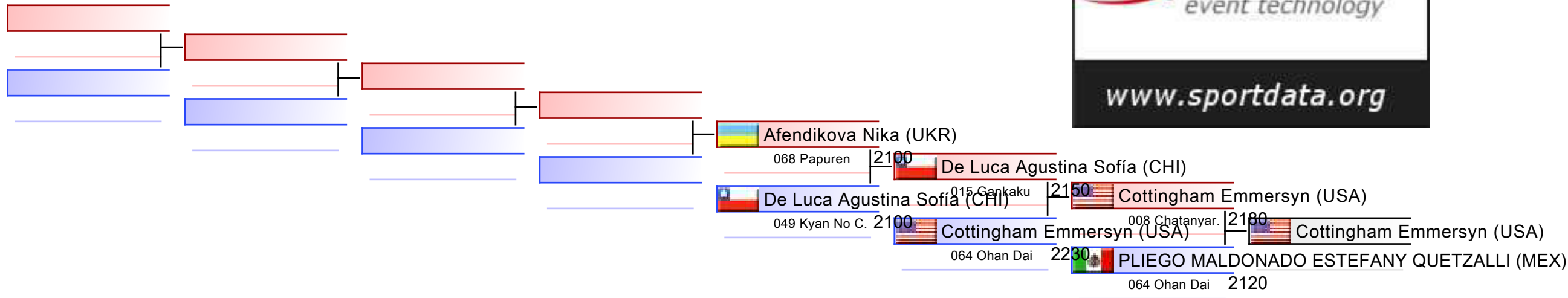

REPECHAGE: (2)

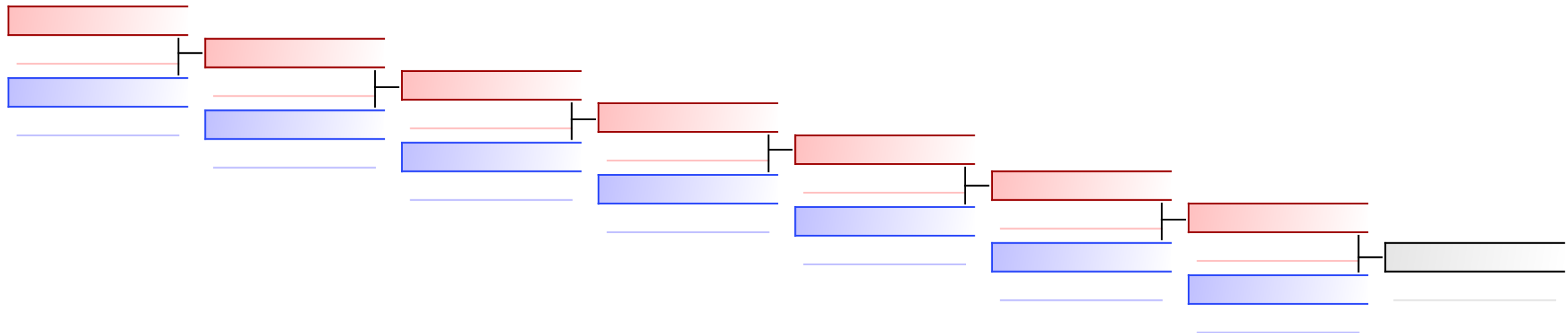

Referees:							
-----------	--	--	--	--	--	--	--



Karate1 Youth League - Cancun 2024 - 2024-08-08



Official Results

Cadet Kata Female			
1	VAUCELLE-SPELLE NINON		FRA - FRANCE
2	SANCHEZ ISABELLA		USA - UNITED STATES
3	COTTINGHAM EMMERSYN		USA - UNITED STATES
3	LEHNER TAMARA		AUT - AUSTRIA
5	PLIEGO MALDONADO ESTEFANY QUETZALLI		MEX - MEXICO
5	DEODHARI SIERRA		USA - UNITED STATES
7	DE LUCA AGUSTINA SOFÍA		CHI - CHILE
7	GATTA LINDA		ITA - ITALY
9	AFENDIKOVA NIKA		UKR - UKRAINE

CADET KATA MALE



Karate1 Youth League - Cancun 2024
ENTRIES BY WEIGHT CATEGORY



Cadet Kata Male
As of 11 AUG 2024

NOC Code	Gender	Name	Seeding
BRA	M	LIBORIO GUSTAVO	
CHI	M	Borquez Arancibia Abraham Guillermo	
COL	M	castillo velez matias	
CRC	M	BONILLAS NICOLAS	
CRC	M	JIMENEZ MATIAS	
CRC	M	MEJIA SEBASTIAN	
CRC	M	MURILLO DERECK	
CZE	M	Šťáhlavský David	
DOM	M	BERA BISONO EMIR	
FRA	M	NGUYEN Toan	
ITA	M	TURCATO GIACOMO FILIPPO	
JAM	M	EVANS RASANDRE VALENTINO	
MEX	M	GARZA VIZCAINO JOSE SANTIAGO	
MEX	M	GONZALEZ RAZO GABRIEL	
MEX	M	GUEVARA VALDEZ DANIEL ALEJANDRO	
MEX	M	JANDA KOBROVA DOMINIK	
MEX	M	RAMOS DEL ANGEL ALFREDO	
MEX	M	RODRIGUEZ VALENCIA LUIS	
PAN	M	JAEN ANTHONY	
POL	M	WAWER WOJCIECH	
SUI	M	Lüthy Corsin Dion	
SUI	M	Mateus Gomes Cristiano	
SUI	M	Mateus Gomes Leonardo	
SWE	M	Erhardt Truls	
SWE	M	Jonasson Jakob	
USA	M	Davila Martin	
USA	M	Isa Cheon	
USA	M	Nguyen Andersen	
USA	M	Nunez Aaron	
USA	M	Salgado Gomez Santiago	
VEN	M	GRECO GIANLUCA	

Cadet Kata Male

Karate1 Youth League - Cancun 2024, Iberostar Playa Paraíso Convention Center, Avenida del Sol Km 309, Playa Paraiso, 77710 Riviera Maya, MEX

2024-08-10

Tatami

3 09:00

Pool

1/2

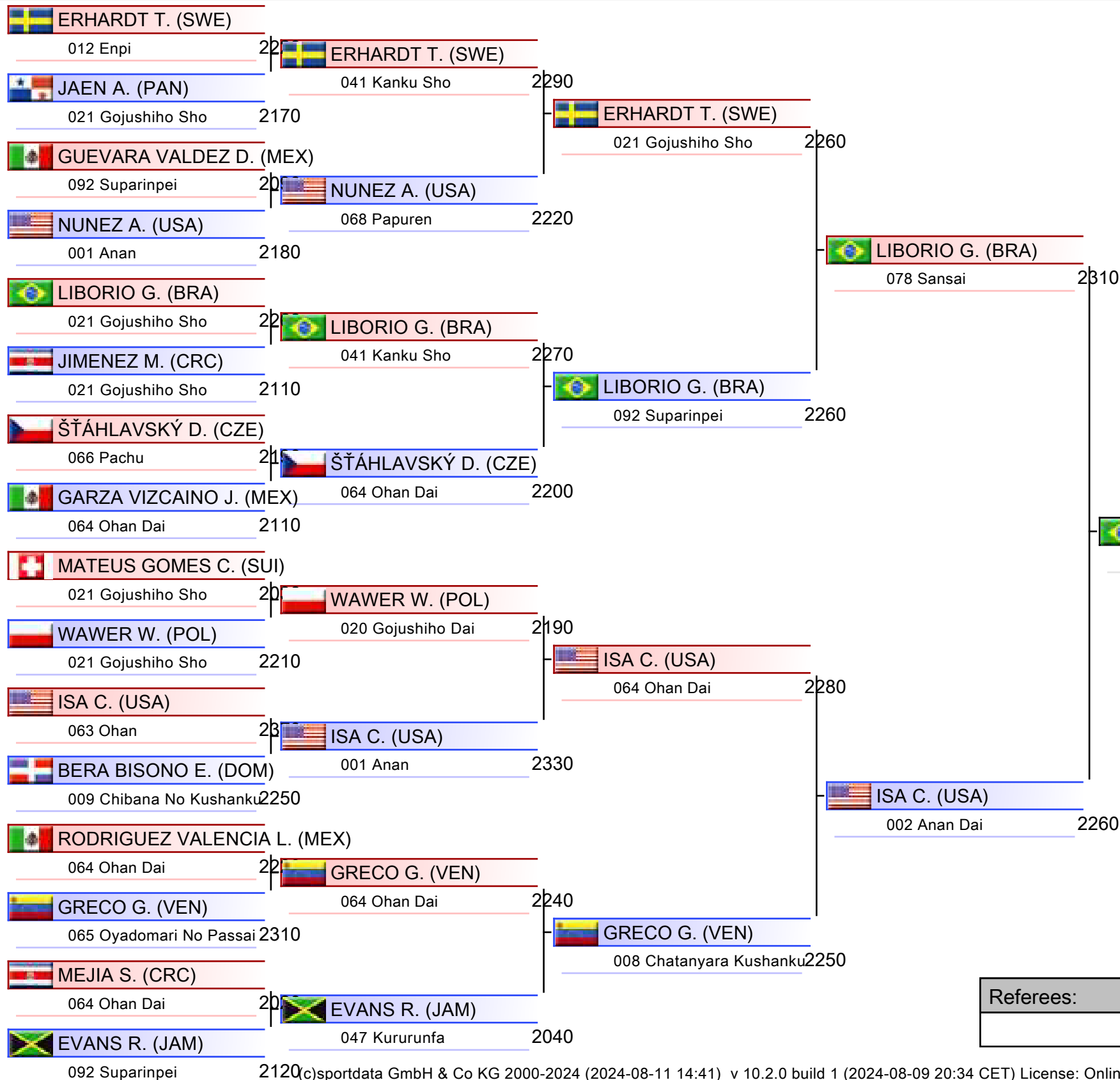

- | |
|----------------------------------|
| 1. LIBORIO GUSTAVO (BRA) |
| 2. TURCATO GIACOMO FILIPPO (ITA) |
| 3. ISA CHEON (USA) |
| 3. GONZALEZ RAZO GABRIEL (MEX) |
| 5. ERHARDT TRULS (SWE) |
| 5. LÜTHY CORSIN DION (SUI) |
| 7. ŠŤÁHLAVSKÝ DAVID (CZE) |
| 7. NGUYEN ANDERSEN (USA) |

Referees:			

Cadet Kata Male

Karate1 Youth League - Cancun 2024, Iberostar Playa Paraíso Convention Center, Avenida del Sol Km 309, Playa Paraiso, 77710 Riviera Maya, MEX

2024-08-10

Tatami
4 09:00

Pool
2/2

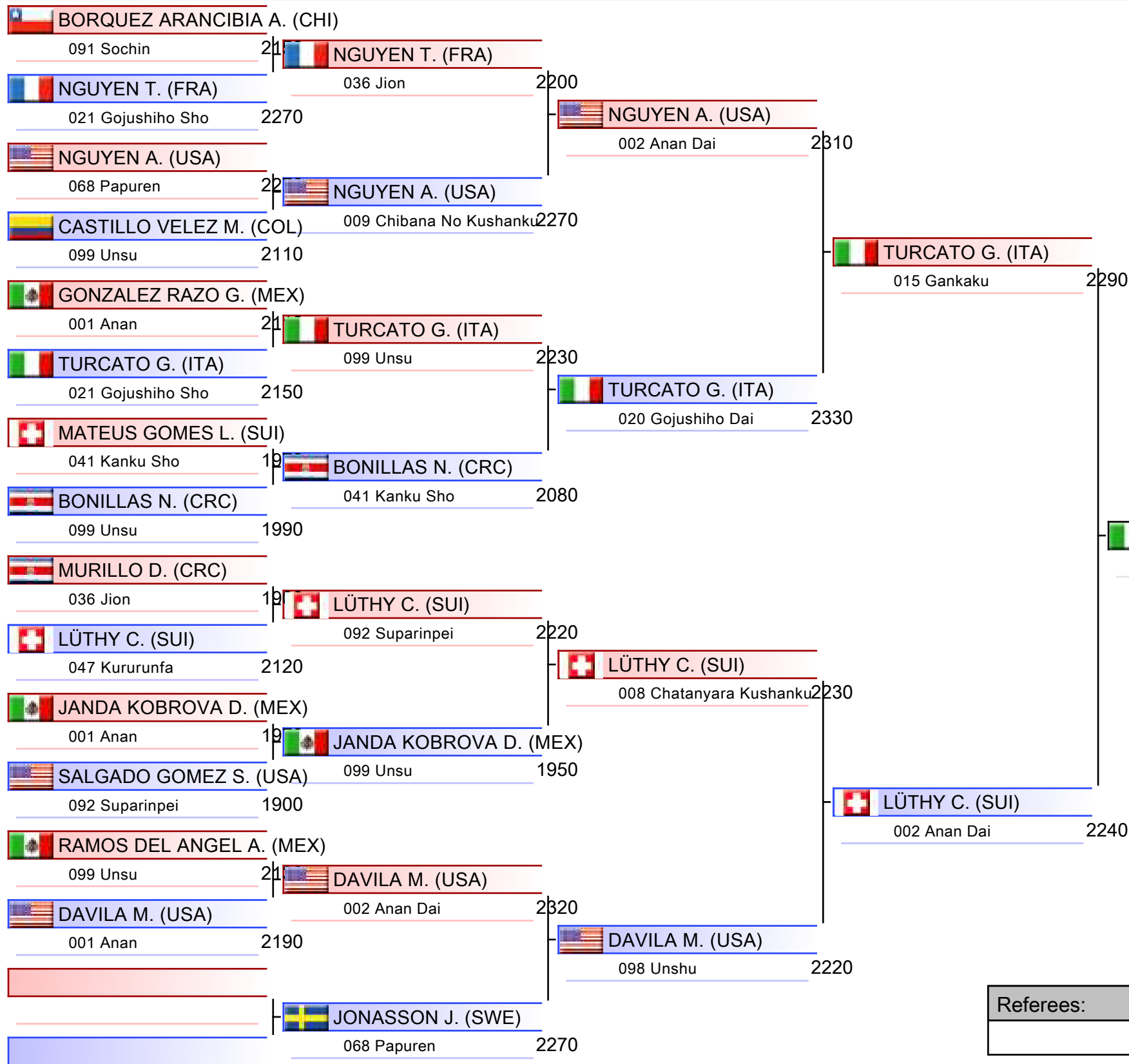

1. LIBORIO GUSTAVO (BRA)
2. TURCATO GIACOMO FILIPPO (ITA)
3. ISA CHEON (USA)
3. GONZALEZ RAZO GABRIEL (MEX)
5. ERHARDT TRULS (SWE)
5. LÜTHY CORSIN DION (SUI)
7. ŠŤÁHLAVSKÝ DAVID (CZE)
7. NGUYEN ANDERSEN (USA)

Referees:			

Pool winner-Cadet Kata Male

Karate1 Youth League - Cancun 2024, Iberostar Playa Paraíso Convention Center, Avenida del Sol Km 309, Playa Paraiso, 77710 Riviera Maya, MEX

Tatami

Pool

1/1

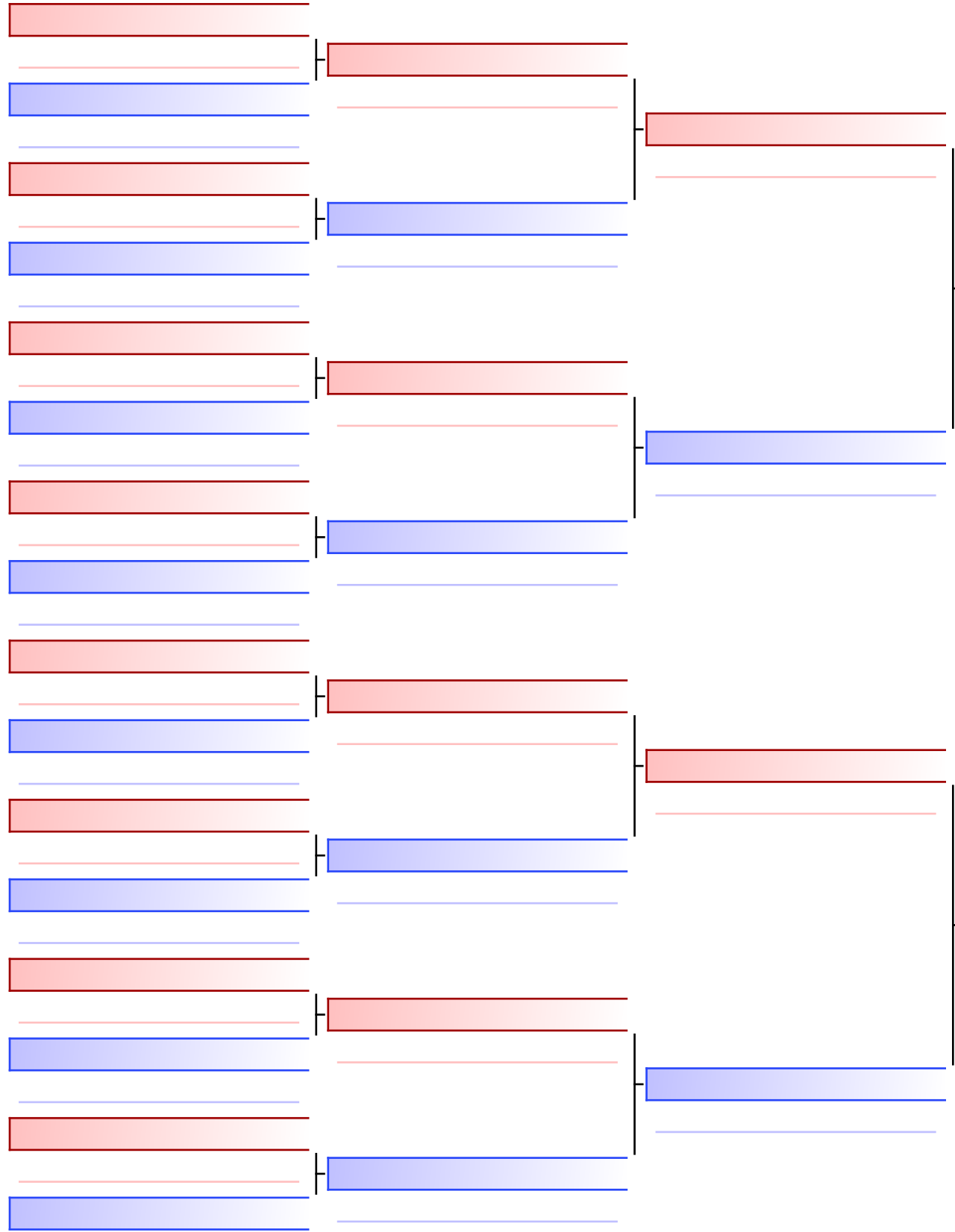

Final

 **LIBORIO G. (BRA)**
099 Unsu 2410

#14 / 10.08

 **LIBORIO G. (BRA)**

 **TURCATO G. (ITA)**
078 Sansai 2280



1. LIBORIO GUSTAVO (BRA)
2. TURCATO GIACOMO FILIPPO (ITA)
3. ISA CHEON (USA)
3. GONZALEZ RAZO GABRIEL (MEX)
5. ERHARDT TRULS (SWE)
5. LÜTHY CORSIN DION (SUI)
7. ŠŤÁHLAVSKÝ DAVID (CZE)
7. NGUYEN ANDERSEN (USA)

Referees:			

Cadet Kata Male

Karate1 Youth League - Cancun 2024

2024-08-10

Tatami
3 11:00

Pool
1

(c)sportdata GmbH & Co KG 2000-2024 (2024-08-11 14:41) v 10.2.0 build 1 (2024-08-09 20:34 CET) License: Online_Event_ID-875_Karate1YouthLeagueCancun2024 (expire 2024-08-25)

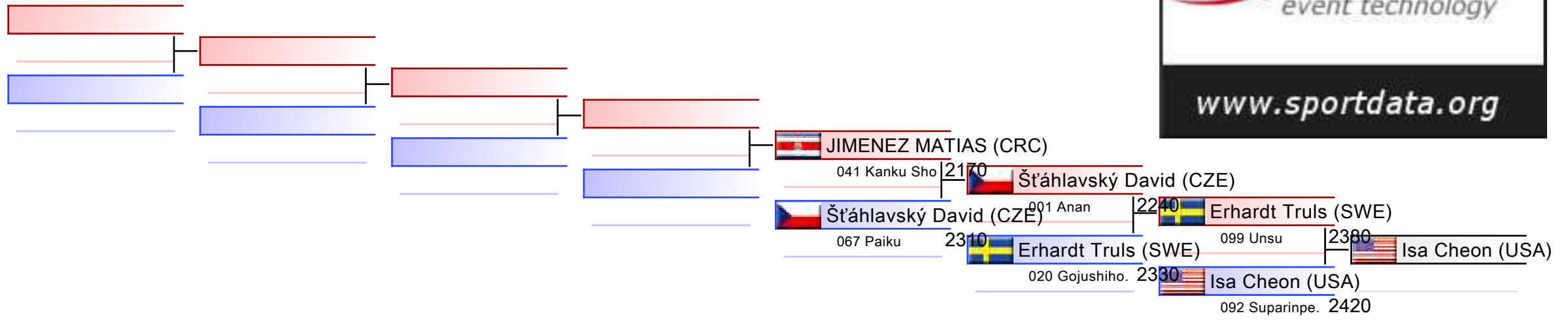

REPECHAGE: (1)

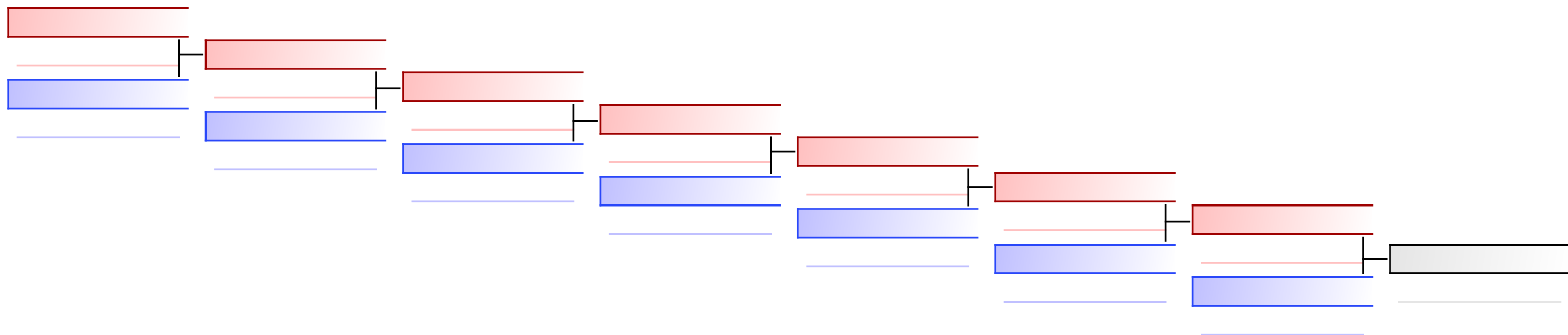

Referees:							
-----------	--	--	--	--	--	--	--

Cadet Kata Male

Karate1 Youth League - Cancun 2024

2024-08-10

Tatami
4 10:55

Pool
2

(c)sportdata GmbH & Co KG 2000-2024 (2024-08-11 14:41) v 10.2.0 build 1 (2024-08-09 20:34 CET) License: Online_Event_ID-875_Karate1YouthLeagueCancun2024 (expire 2024-08-25)

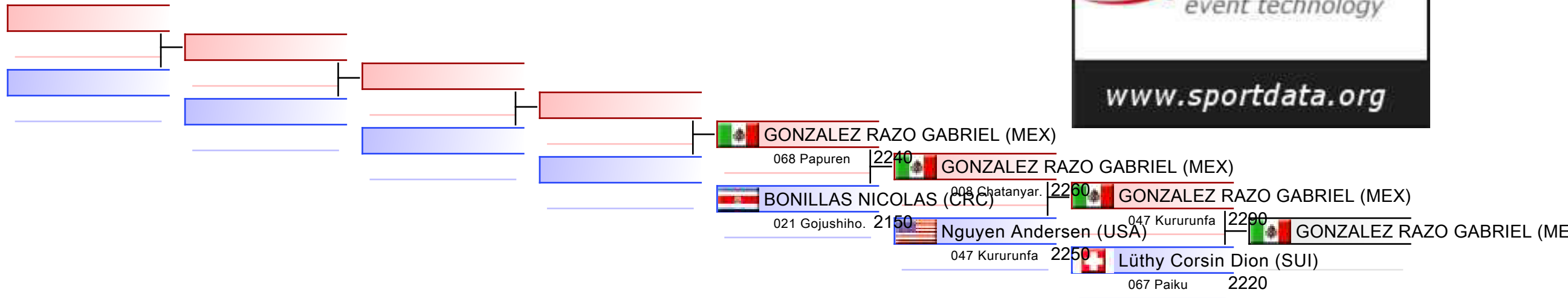

REPECHAGE: (2)

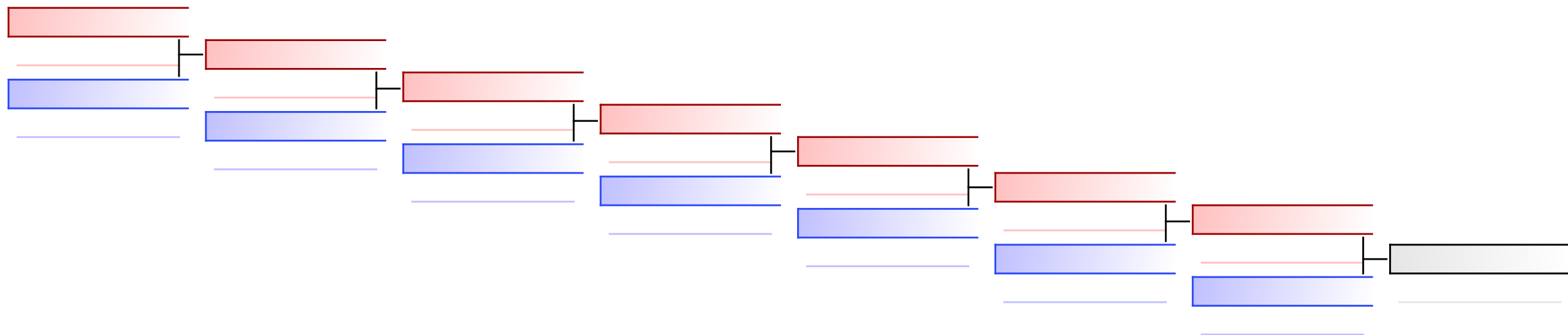

Referees:							
-----------	--	--	--	--	--	--	--



Karate1 Youth League - Cancun 2024 - 2024-08-08



Official Results

Cadet Kata Male			
1	LIBORIO GUSTAVO		BRA - BRAZIL
2	TURCATO GIACOMO FILIPPO		ITA - ITALY
3	ISA CHEON		USA - UNITED STATES
3	GONZALEZ RAZO GABRIEL		MEX - MEXICO
5	ERHARDT TRULS		SWE - SWEDEN
5	LÜTHY CORSIN DION		SUI - SWITZERLAND
7	ŠTAHLAVSKÝ DAVID		CZE - CZECH REPUBLIC
7	NGUYEN ANDERSEN		USA - UNITED STATES
9	JIMENEZ MATIAS		CRC - COSTA RICA
9	BONILLAS NICOLAS		CRC - COSTA RICA

CADET KUMITE FEMALE -47 KG



Karate1 Youth League - Cancun 2024
ENTRIES BY WEIGHT CATEGORY



Cadet Kumite Female -47 kg
As of 11 AUG 2024

NOC Code	Gender	Name	Seeding
AUS	F	CHOI LAWRENCE LUCY	
CRC	F	LOPEZ SASHA	
CRC	F	RODRIGUEZ ISABELLA	
CRC	F	VASQUEZ AMY	
GUA	F	COY AJU DAGNY NAHOMI	
MEX	F	CATALAN BARRIENTOS ANETTE	
MEX	F	ROSALES MATA GEMA SELENIA	
NCA	F	PAULINA RIOS CHAVARRIA	
POR	F	Fernandes Ema Pinéu	
POR	F	Matos Isis	
USA	F	Abu-Rahma Mariam	
USA	F	Sanchez Isabella	

Cadet Kumite Female -47 kg

Karate1 Youth League - Cancun 2024, Iberostar Playa Paraíso Convention Center, Avenida del Sol Km 309, Playa Paraiso, 77710 Riviera Maya, MEX

2024-08-10

Tatami

1 11:30

Pool

1/1

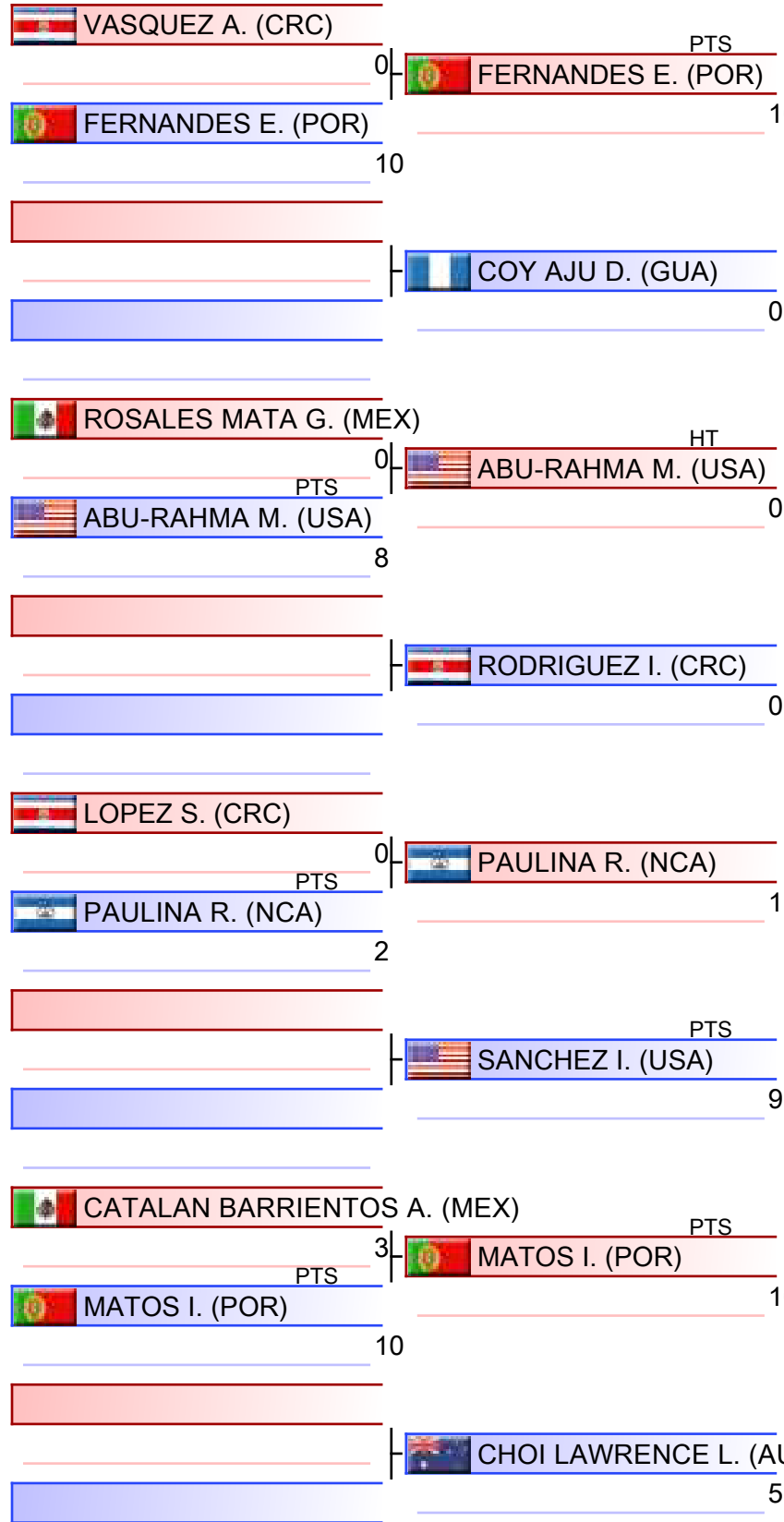

Final

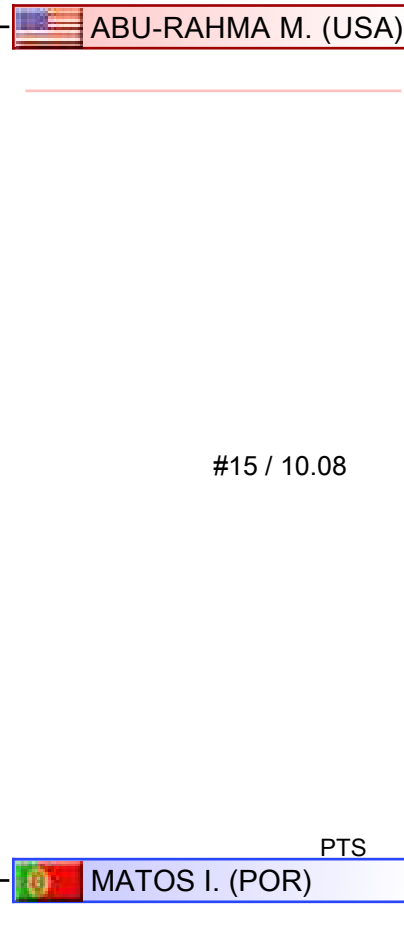

#15 / 10.08



1. MATOS ISIS (POR)
2. ABU-RAHMA MARIAM (USA)
3. SANCHEZ ISABELLA (USA)
3. FERNANDES EMA PINÉU (POR)
5. CHOI LAWRENCE LUCY (AUS)
5. RODRIGUEZ ISABELLA (CRC)
7. CATALAN BARRIENTOS ANETTE (MEX)
7. ROSALES MATA GEMA SELENIA (MEX)

Referees:			

Cadet Kumite Female -47 kg

Karate1 Youth League - Cancun 2024

2024-08-10

Tatami
1 12:20

Pool
1

(c)sportdata GmbH & Co KG 2000-2024 (2024-08-11 14:41) v 10.2.0 build 1 (2024-08-09 20:34 CET) License: Online_Event_ID-875_Karate1YouthLeagueCancun2024 (expire 2024-08-25)

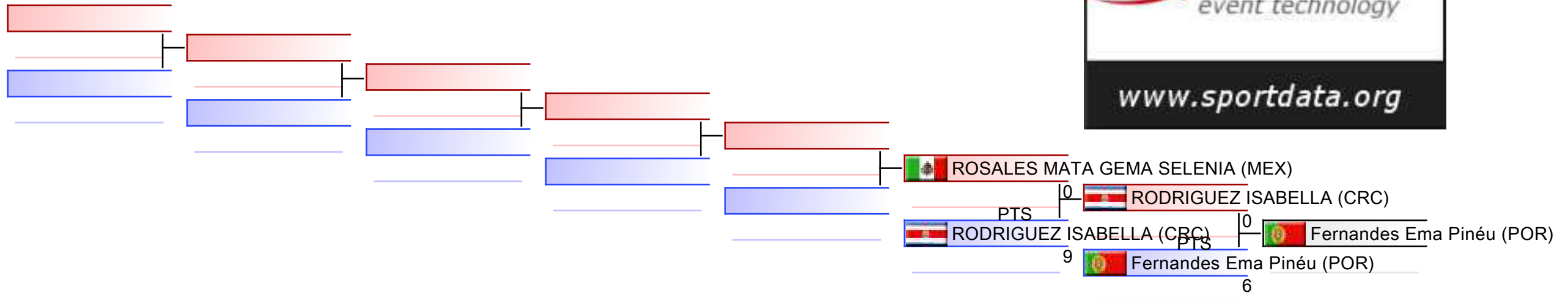

REPECHAGE: (1)

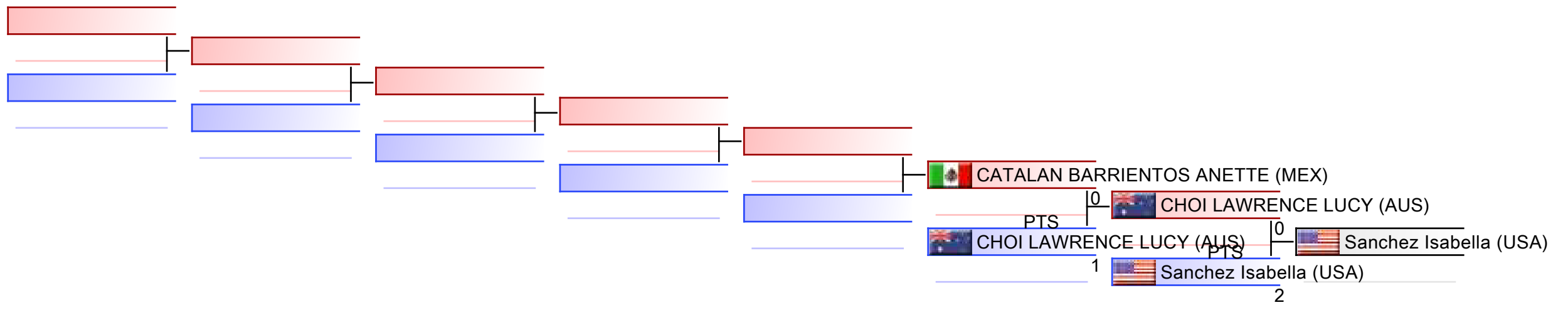

Referees:							
-----------	--	--	--	--	--	--	--



Karate1 Youth League - Cancun 2024 - 2024-08-08



Official Results

Cadet Kumite Female -47 kg			
1	MATOS ISIS		POR - PORTUGAL
2	ABU-RAHMA MARIAM		USA - UNITED STATES
3	SANCHEZ ISABELLA		USA - UNITED STATES
3	FERNANDES EMA PINÉU		POR - PORTUGAL
5	CHOI LAWRENCE LUCY		AUS - AUSTRALIA
5	RODRIGUEZ ISABELLA		CRC - COSTA RICA
7	CATALAN BARRIENTOS ANETTE		MEX - MEXICO
7	ROSALES MATA GEMA SELENIA		MEX - MEXICO

CADET KUMITE FEMALE -54 KG



Karate1 Youth League - Cancun 2024
ENTRIES BY WEIGHT CATEGORY



Cadet Kumite Female -54 kg
As of 11 AUG 2024

NOC Code	Gender	Name	Seeding
CAN	F	BEAUDET ALICE	
CHI	F	Contreras Villavicencio Bianca amyra	
COL	F	LONDONO ANDREA VALENTINA	
CRC	F	RODRIGUEZ MORENO NAHOMY	
MEX	F	ESCOBEDO CASTAÑEDA METZTLI	
MEX	F	GARZA VIZCAINO VALENTINA	
MEX	F	QUINTERO AVAS YUBIA MARINA	
MEX	F	VALLEJOS CAAMAL REBECA CATALINA	
POR	F	Gonçalves Leonor	
POR	F	Silva Maria	
POR	F	Varanda Gabriela	
USA	F	Andreevski Angelina	
USA	F	Guaitarilla Kamila	

Cadet Kumite Female -54 kg

Karate1 Youth League - Cancun 2024, Iberostar Playa Paraíso Convention Center, Avenida del Sol Km 309, Playa Paraiso, 77710 Riviera Maya, MEX

2024-08-10

Tatami

2 11:30

Pool

1/1

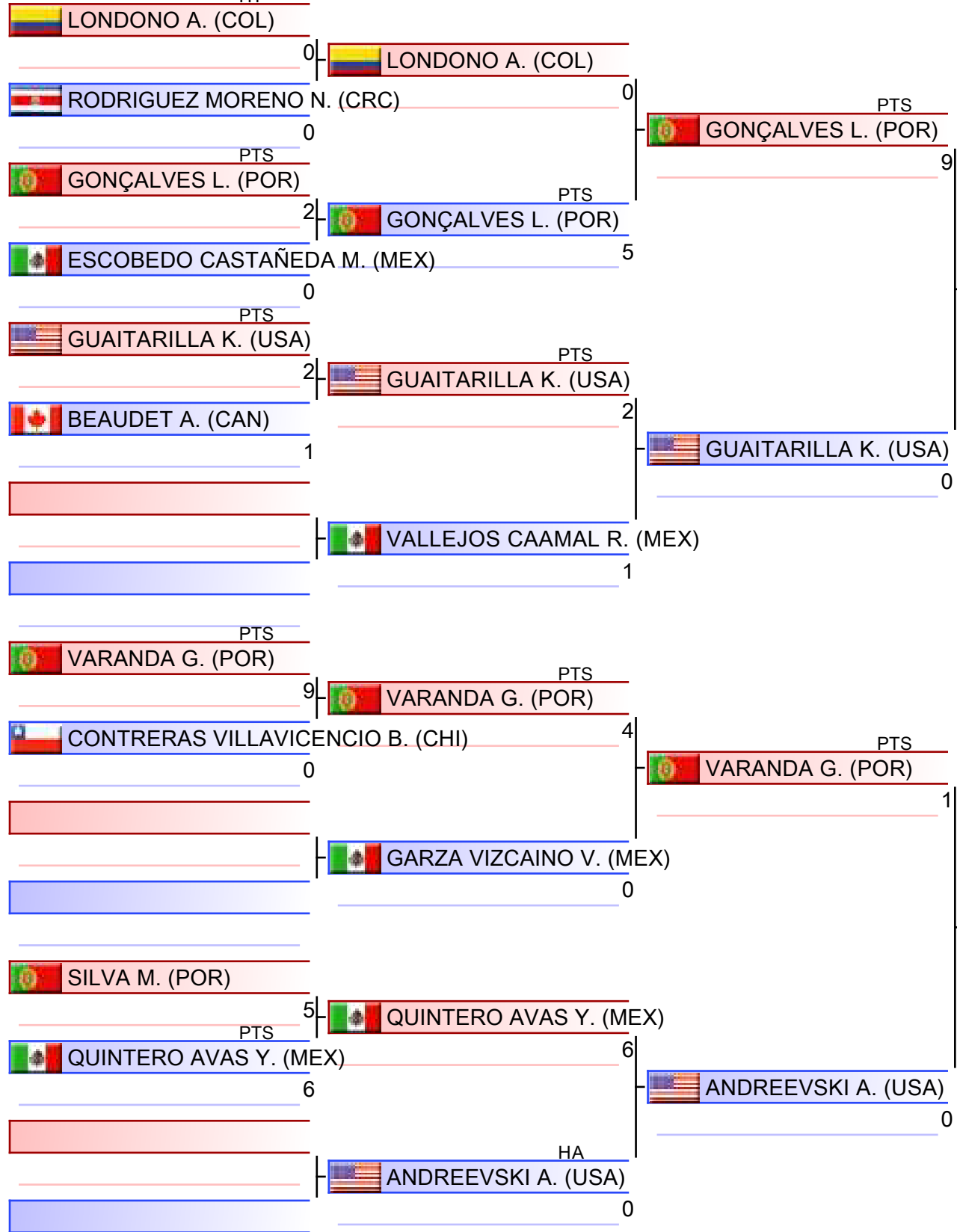

- | |
|---|
| 1. GONÇALVES LEONOR (POR) |
| 2. VARANDA GABRIELA (POR) |
| 3. ESCOBEDO CASTAÑEDA METZTLI (MEX) |
| 3. ANDREEVSKI ANGELINA (USA) |
| 5. GUAITARILLA KAMILA (USA) |
| 5. CONTRERAS VILLAVICENCIO BIANCA AMYRA |
| 7. LONDONO ANDREA VALENTINA (COL) |
| 7. GARZA VIZCAINO VALENTINA (MEX) |

Referees:			

Cadet Kumite Female -54 kg

Karate1 Youth League - Cancun 2024

2024-08-10

Tatami
2 12:25

Pool
1

(c)sportdata GmbH & Co KG 2000-2024 (2024-08-11 14:41) v 10.2.0 build 1 (2024-08-09 20:34 CET) License: Online_Event_ID-875_Karate1YouthLeagueCancun2024 (expire 2024-08-25)

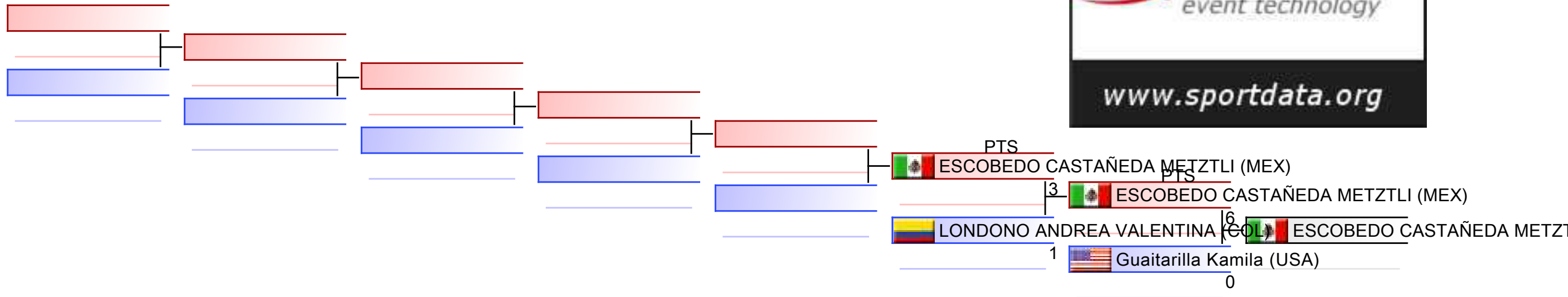

REPECHAGE: (1)

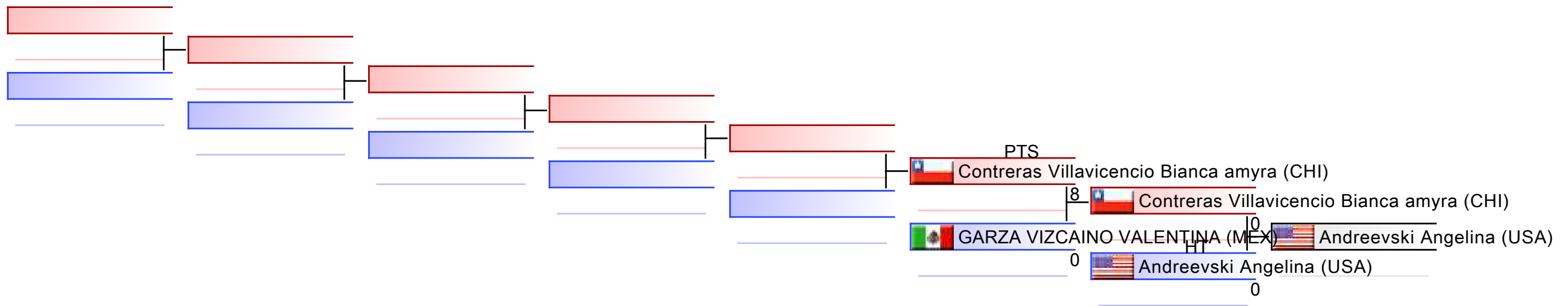

Referees:							
-----------	--	--	--	--	--	--	--



Karate1 Youth League - Cancun 2024 - 2024-08-08



Official Results

Cadet Kumite Female -54 kg			
1	GONÇALVES LEONOR		POR - PORTUGAL
2	VARANDA GABRIELA		POR - PORTUGAL
3	ESCOBEDO CASTAÑEDA METZTLI		MEX - MEXICO
3	ANDREEVSKI ANGELINA		USA - UNITED STATES
5	GUAITARILLA KAMILA		USA - UNITED STATES
5	CONTRERAS VILLAVICENCIO BIANCA AMYRA		CHI - CHILE
7	LONDONO ANDREA VALENTINA		COL - COLOMBIA
7	GARZA VIZCAINO VALENTINA		MEX - MEXICO

CADET KUMITE FEMALE -61 KG



Karate1 Youth League - Cancun 2024
ENTRIES BY WEIGHT CATEGORY



Cadet Kumite Female -61 kg
As of 11 AUG 2024

NOC Code	Gender	Name	Seeding
CAN	F	RAHMANI AYA	
CHI	F	DONOSO ALMONACID MAITE	
CHI	F	Oyarce Agustina	
CRC	F	MORA ALFARO ALOIS	
CRO	F	MAGDALENIC PAULINA	
DEN	F	Bath Hannah	
ESP	F	SKIBA BIRKELBACH AMELIE YAIZA	
GUA	F	REYES REYNA EMILIA ESTER	
ISL	F	Halldórsdóttir Embla	
MEX	F	DAVILA LOPEZ BARBARA ITZEL	
MEX	F	RAMIREZ MIRANDA FERNANDA MARISOL	
MEX	F	SERRANO JIMENEZ SOPHIA YAHELI	
MEX	F	SOLIS PAT MARIA JOSE	
PER	F	Congona Leon Geraldine Nicole	
USA	F	Kumsi Shriya	

Cadet Kumite Female -61 kg

Karate1 Youth League - Cancun 2024, Iberostar Playa Paraíso Convention Center, Avenida del Sol Km 309, Playa Paraiso, 77710 Riviera Maya, MEX

2024-08-10

Tatami
3 12:50

Pool
1/1

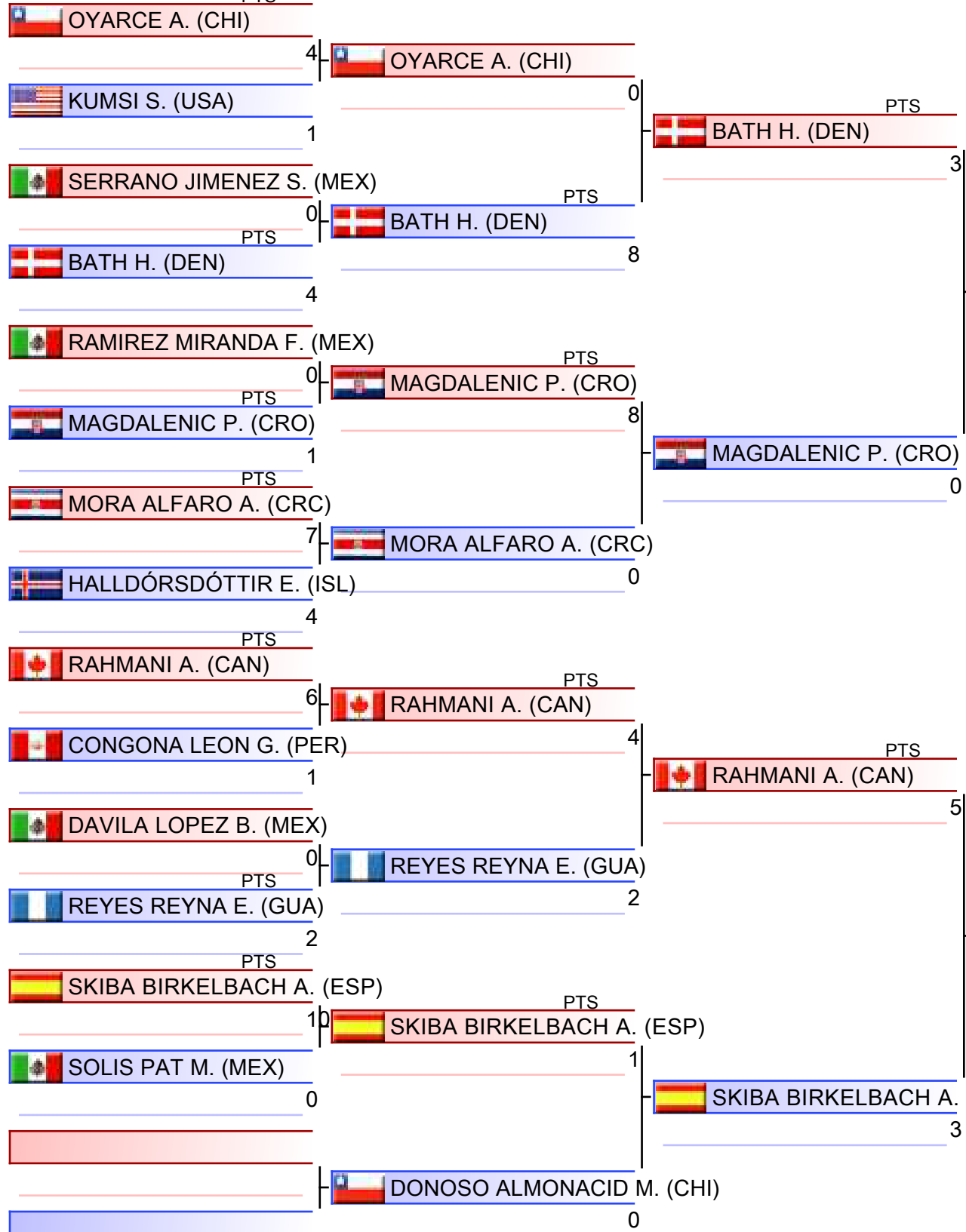

- | |
|--|
| 1. BATH HANNAH (DEN) |
| 2. RAHMANI AYA (CAN) |
| 3. MAGDALENIC PAULINA (CRO) |
| 3. SKIBA BIRKELBACH AMELIE YAIZA (ESP) |
| 5. SERRANO JIMENEZ SOPHIA YABELI (MEX) |
| 5. REYES REYNA EMILIA ESTER (GUA) |
| 7. OYARCE AGUSTINA (CHI) |
| 7. CONGONA LEON GERALDINE NICOLE (PER) |

Referees:			

Cadet Kumite Female -61 kg

Karate1 Youth League - Cancun 2024

2024-08-10

Tatami
3 13:55

Pool
1

(c)sportdata GmbH & Co KG 2000-2024 (2024-08-11 14:41) v 10.2.0 build 1 (2024-08-09 20:34 CET) License: Online_Event_ID-875_Karate1YouthLeagueCancun2024 (expire 2024-08-25)

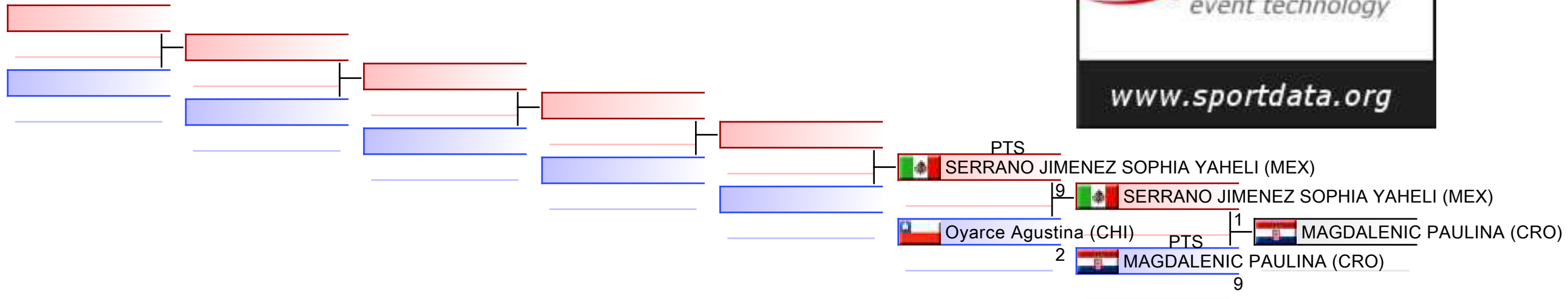

REPECHAGE: (1)

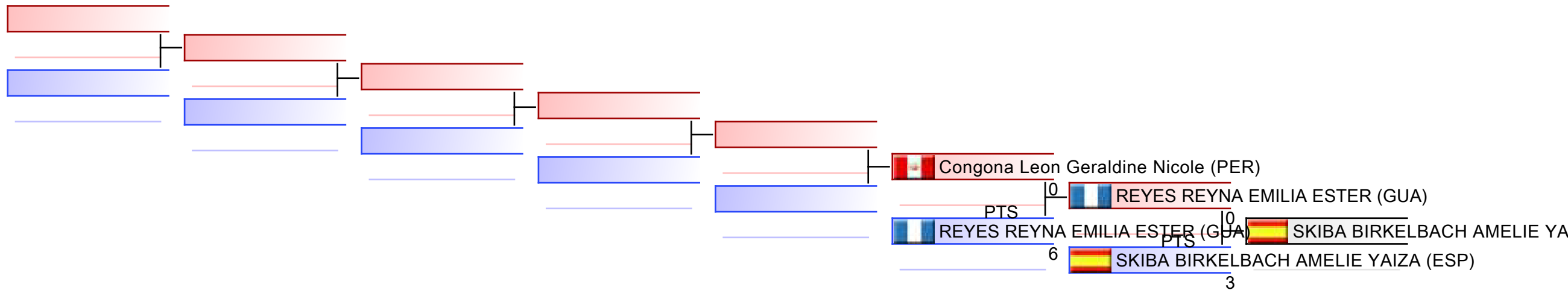

Referees:							
-----------	--	--	--	--	--	--	--



Karate1 Youth League - Cancun 2024 - 2024-08-08



Official Results

Cadet Kumite Female -61 kg			
1	BATH HANNAH		DEN - DENMARK
2	RAHMANI AYA		CAN - CANADA
3	MAGDALENIC PAULINA		CRO - CROATIA
3	SKIBA BIRKELBACH AMELIE YAIZA		ESP - SPAIN
5	SERRANO JIMENEZ SOPHIA YAHILI		MEX - MEXICO
5	REYES REYNA EMILIA ESTER		GUA - GUATEMALA
7	OYARCE AGUSTINA		CHI - CHILE
7	CONGONA LEON GERALDINE NICOLE		PER - PERU

CADET KUMITE FEMALE 61+ KG



Karate1 Youth League - Cancun 2024
ENTRIES BY WEIGHT CATEGORY



Cadet Kumite Female 61+ kg
As of 11 AUG 2024

NOC Code	Gender	Name	Seeding
AUT	F	KEMETINGER SARAH	
CAN	F	GUERRERO MARIANA	
CHI	F	AGUILERA PEREZ PAULA	
CHI	F	ALVARADO MYHELLEN	
CHI	F	Núñez Daniela	
CHI	F	Sepúlveda Ly Flavia Emilia	
CHI	F	Vega ruz Isidora Agustina	
CHI	F	Vera Gazmuri Martina	
CRC	F	CORDERO MARIEL	
GER	F	Gräfe Lotte	
GER	F	Schindler Miley	
MEX	F	HERNANDEZ DIAZ NAOMY	
MEX	F	HERNANDEZ VAZQUEZ DAFNE YARETZI	
MEX	F	JUAREZ MARTINEZ VALERIA LINETT	
MEX	F	Lopez Cerro Ingrid Vanessa	
MEX	F	MENDOZA PEREZ XADANI XIOMARA	
MEX	F	SANCHEZ GRUJIC ANA CAROLINA	
MLT	F	ANTONELLI THYIS	
SCO	F	Ewing Maia	
USA	F	Harling Skyla	
USA	F	Hong Sophia	

Cadet Kumite Female 61+ kg

Karate1 Youth League - Cancun 2024, Iberostar Playa Paraíso Convention Center, Avenida del Sol Km 309, Playa Paraiso, 77710 Riviera Maya, MEX

2024-08-10

Tatami
1 12:40

Pool
1/2

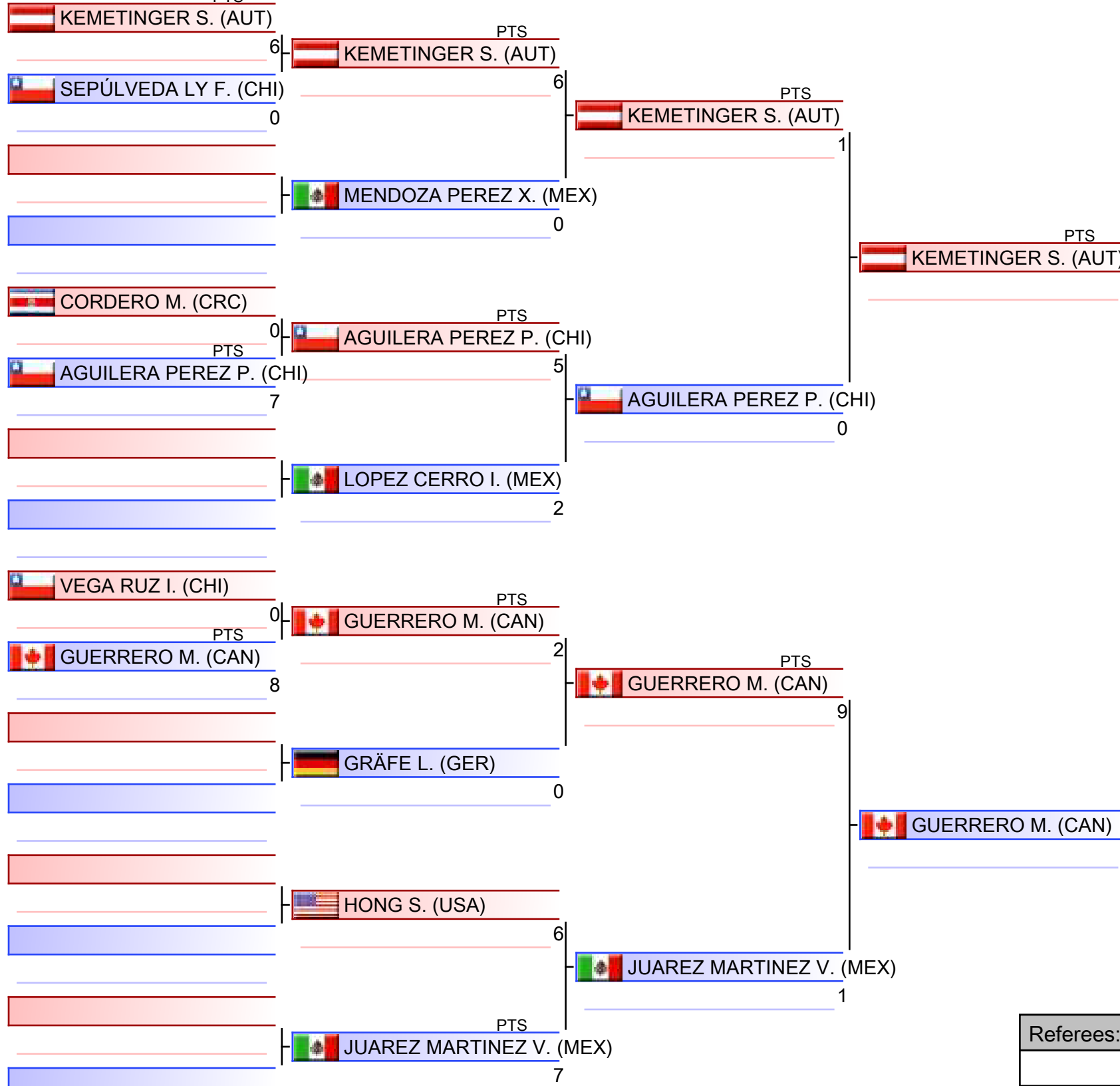

1. KEMETINGER SARAH (AUT)
2. HARLING SKYLA (USA)
3. GUERRERO MARIANA (CAN)
3. EWING MAIA (SCO)
5. AGUILERA PEREZ PAULA (CHI)
5. ALVARADO MYHELLEN (CHI)
7. SEPÚLVEDA LY FLAVIA EMILIA (CHI)
7. SCHINDLER MILEY (GER)

Referees:			

Cadet Kumite Female 61+ kg

Karate1 Youth League - Cancun 2024, Iberostar Playa Paraíso Convention Center, Avenida del Sol Km 309, Playa Paraiso, 77710 Riviera Maya, MEX

2024-08-10

Tatami
2 12:45

Pool
2/2

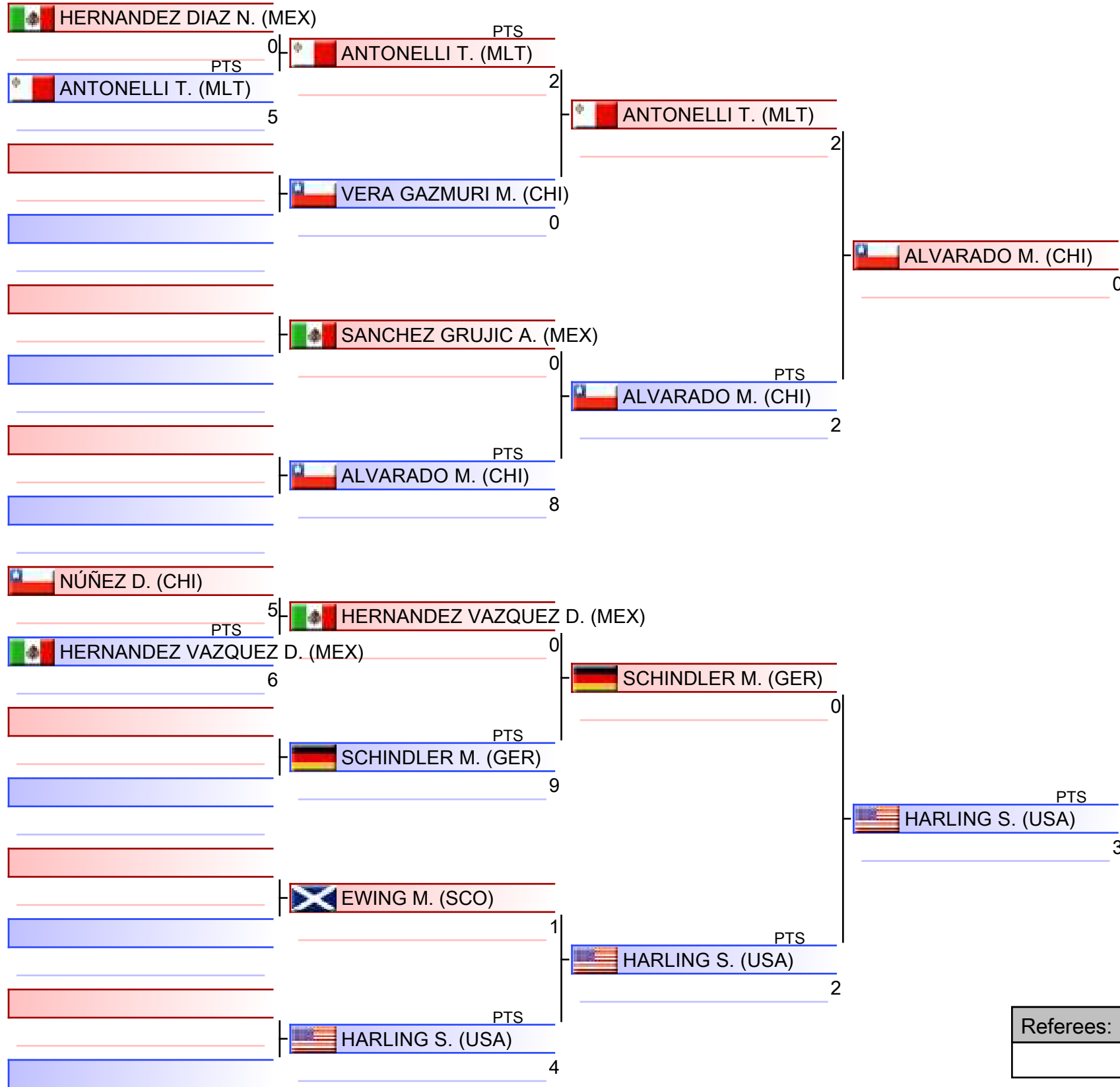

1. KEMETINGER SARAH (AUT)
2. HARLING SKYLA (USA)
3. GUERRERO MARIANA (CAN)
3. EWING MAIA (SCO)
5. AGUILERA PEREZ PAULA (CHI)
5. ALVARADO MYHELLEN (CHI)
7. SEPÚLVEDA LY FLAVIA EMILIA (CHI)
7. SCHINDLER MILEY (GER)

Referees:			

Pool winner-Cadet Kumite Female 61+ kg

Karate1 Youth League - Cancun 2024, Iberostar Playa Paraiso Convention Center, Avenida del Sol Km 309, Playa Paraiso, 77710 Riviera Maya, MEX

Tatami

Pool

1/1

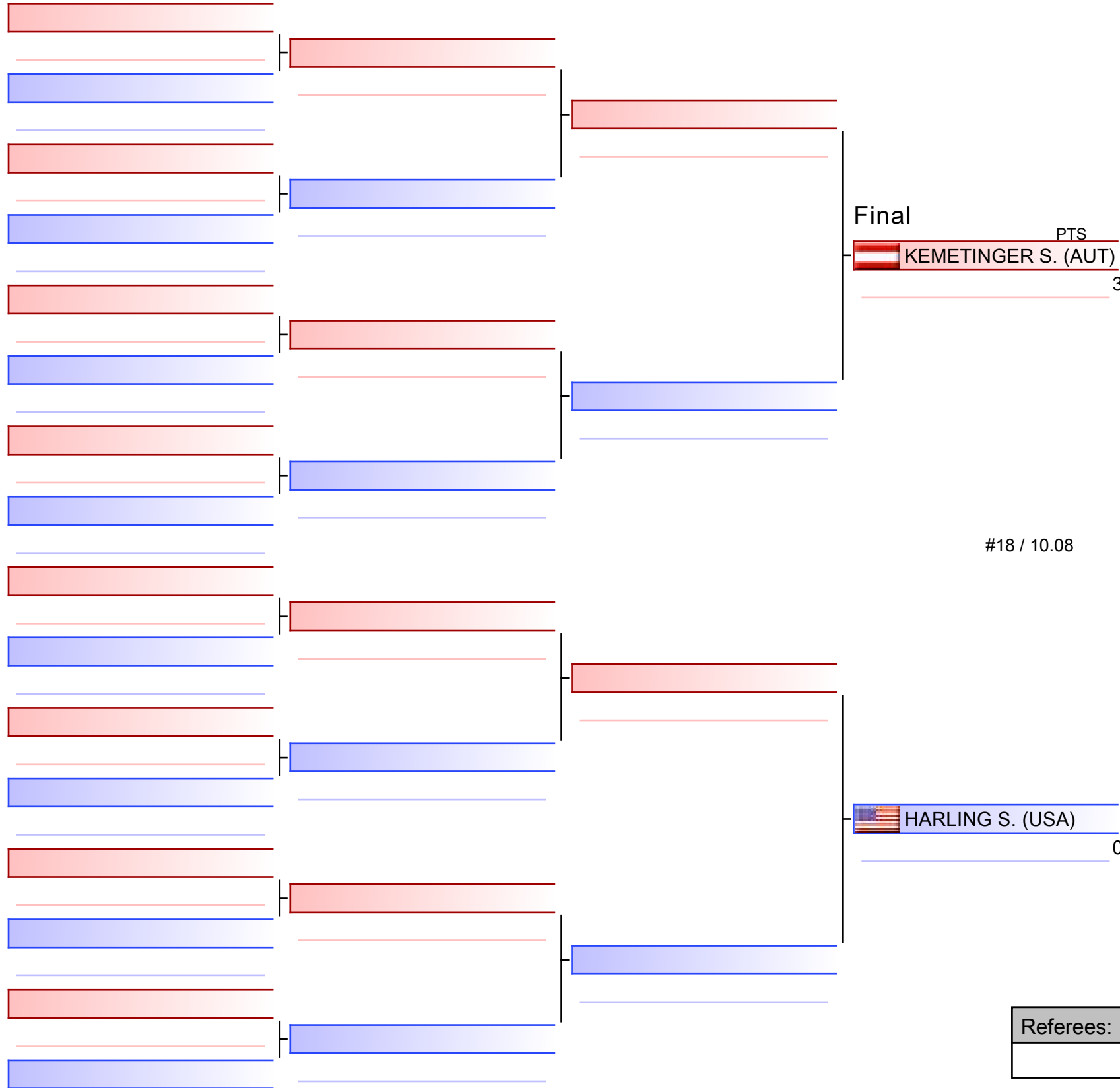

KEMETINGER S. (AUT)

- | |
|-------------------------------------|
| 1. KEMETINGER SARAH (AUT) |
| 2. HARLING SKYLA (USA) |
| 3. GUERRERO MARIANA (CAN) |
| 3. EWING MAIA (SCO) |
| 5. AGUILERA PEREZ PAULA (CHI) |
| 5. ALVARADO MYHELLEN (CHI) |
| 7. SEPÚLVEDA LY FLAVIA EMILIA (CHI) |
| 7. SCHINDLER MILEY (GER) |

Referees:			

Cadet Kumite Female 61+ kg

Karate1 Youth League - Cancun 2024

2024-08-10

Tatami
1 13:30

Pool
1,2

(c)sportdata GmbH & Co KG 2000-2024 (2024-08-11 14:41) v 10.2.0 build 1 (2024-08-09 20:34 CET) License: Online_Event_ID-875_Karate1YouthLeagueCancun2024 (expire 2024-08-25)

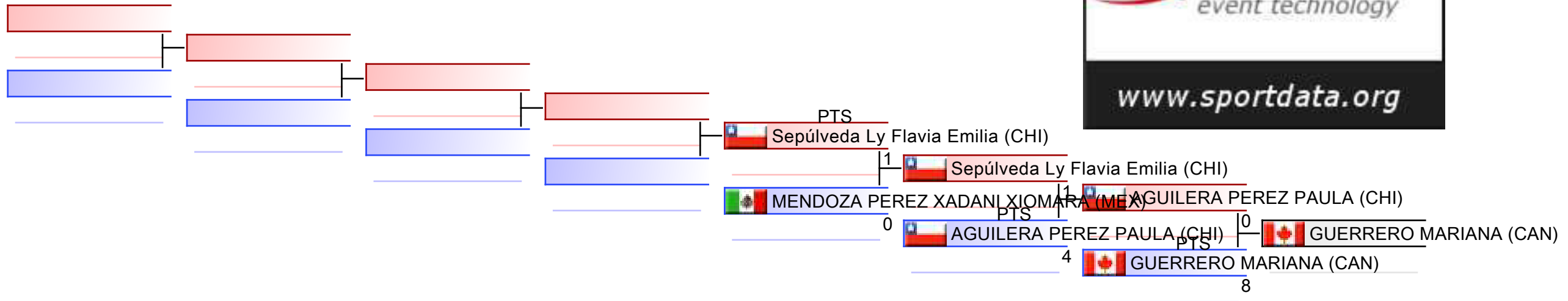

REPECHAGE: (1,2)

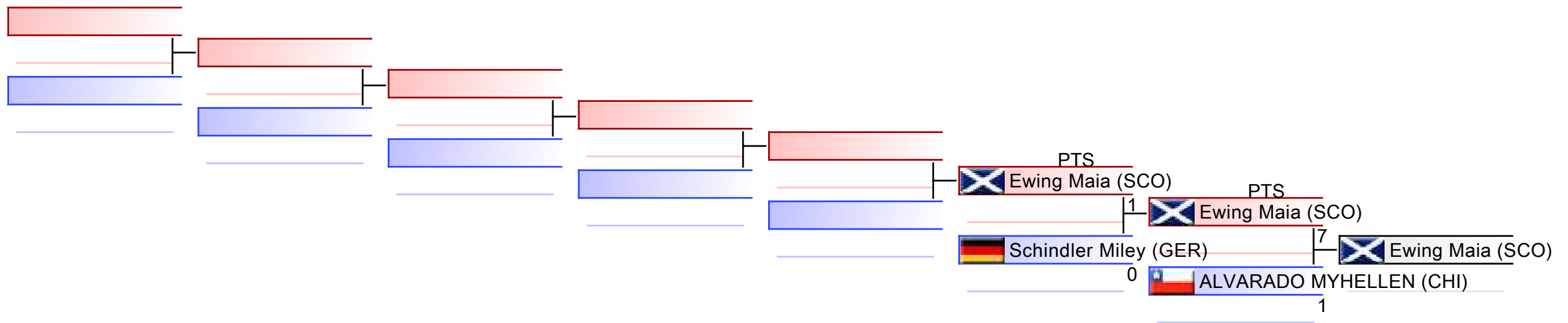

Referees:							
-----------	--	--	--	--	--	--	--



Karate1 Youth League - Cancun 2024 - 2024-08-08



Official Results

Cadet Kumite Female 61+ kg			
1	KEMETINGER SARAH		AUT - AUSTRIA
2	HARLING SKYLA		USA - UNITED STATES
3	GUERRERO MARIANA		CAN - CANADA
3	EWING MAIA		SCO - SCOTLAND
5	AGUILERA PEREZ PAULA		CHI - CHILE
5	ALVARADO MYHELLEN		CHI - CHILE
7	SEPULVEDA LY FLAVIA EMILIA		CHI - CHILE
7	SCHINDLER MILEY		GER - GERMANY
9	MENDOZA PEREZ XADANI XIOMARA		MEX - MEXICO

CADET KUMITE MALE -52 KG



Karate1 Youth League - Cancun 2024
ENTRIES BY WEIGHT CATEGORY



Cadet Kumite Male -52 kg
As of 11 AUG 2024

NOC Code	Gender	Name	Seeding
CHI	M	Araya Astengo Joaquín Alonso	
CHI	M	OYARZUN BAHAMONDE ALONSO	
CHI	M	Puga rojas Emilio Alonso	
CHI	M	SANCHEZ BAHAMONDE VICENTE	
ESP	M	PETAGNA LOPEZ PAOLO	
GER	M	Namyslik Felix	
GRE	M	FILIAGKOS ATHANASIOS	
MEX	M	ALMEIDA CHAVEZ MARCO ANTONIO	
MEX	M	GALEOTE TIERRABLANCA ITAN SAID	
MEX	M	GARCIA VALADEZ MATEO	
MEX	M	GUEVARA VALDEZ DANIEL ALEJANDRO	
MEX	M	INIESTA MEZA HECTOR LEONARDO	
MEX	M	SALGADO RUEDA DIEGO	
PER	M	ITURBE PAUCAR THIAGO GAEL	
SUI	M	Lüthy Corsin Dion	
SUI	M	Mateus Gomes Cristiano	
SUI	M	Mateus Gomes Leonardo	
SUI	M	Zecca Lucas	
USA	M	Belfand Paul	
USA	M	Nunez Aaron	
USA	M	Salgado Gomez Santiago	

Cadet Kumite Male -52 kg

Karate1 Youth League - Cancun 2024, Iberostar Playa Paraíso Convention Center, Avenida del Sol Km 309, Playa Paraiso, 77710 Riviera Maya, MEX

2024-08-10

Tatami
3 11:30

Pool
1/2

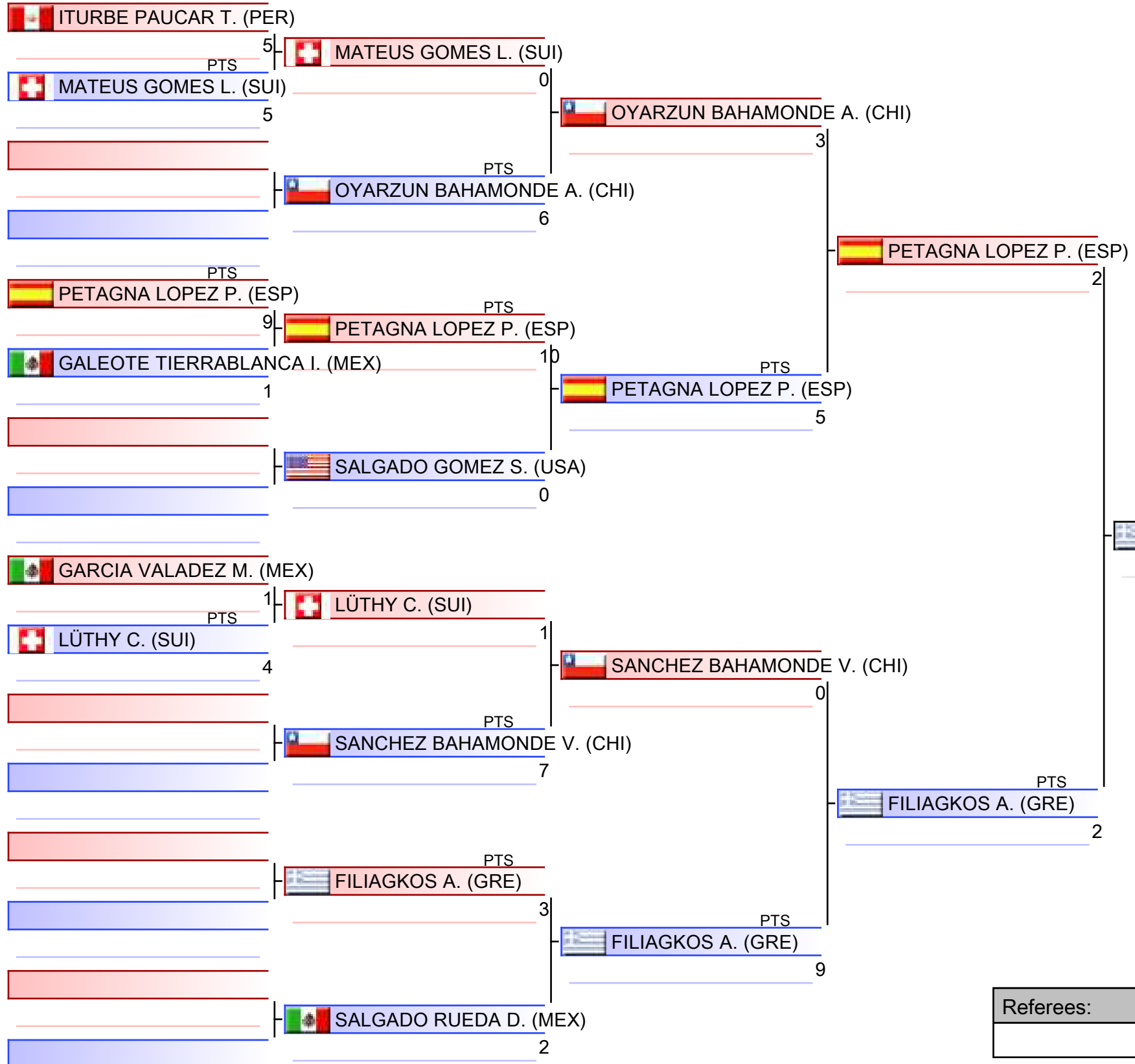

1. ZECCA LUCAS (SUI)
2. FILIAGKOS ATHANASIOS (GRE)
3. GUEVARA VALDEZ DANIEL ALEJANDRO (MEX)
3. PETAGNA LOPEZ PAOLO (ESP)
5. NUNEZ AARON (USA)
5. SANCHEZ BAHAMONDE VICENTE (CHI)
7. BELFAND PAUL (USA)
7. SALGADO RUEDA DIEGO (MEX)

Referees:			

Cadet Kumite Male -52 kg

Karate1 Youth League - Cancun 2024, Iberostar Playa Paraíso Convention Center, Avenida del Sol Km 309, Playa Paraiso, 77710 Riviera Maya, MEX

2024-08-10

Tatami
4 11:30

Pool
2/2

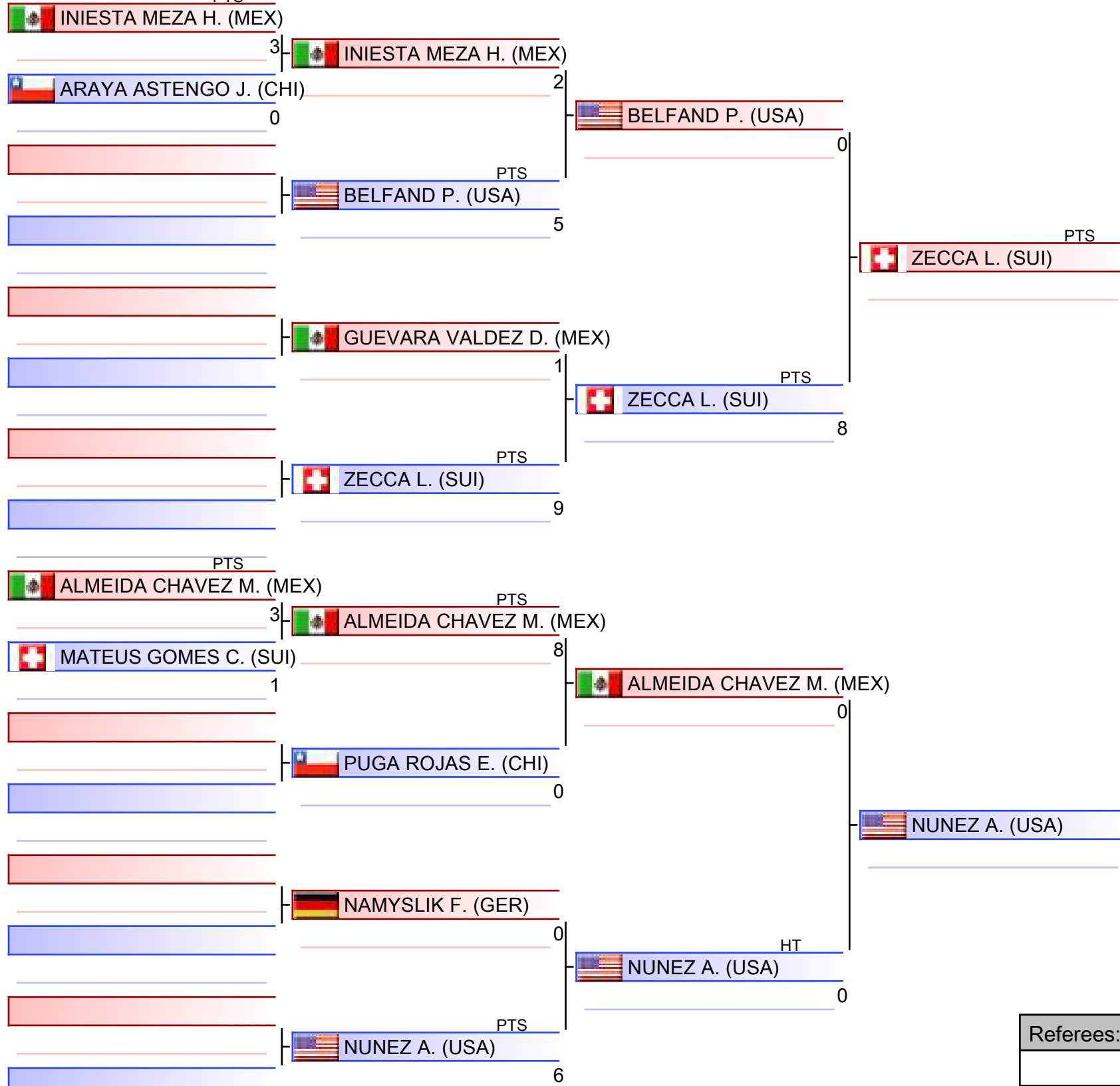

1. ZECCA LUCAS (SUI)
2. FILIAGKOS ATHANASIOS (GRE)
3. GUEVARA VALDEZ DANIEL ALEJANDRO (MEX)
3. PETAGNA LOPEZ PAOLO (ESP)
5. NUNEZ AARON (USA)
5. SANCHEZ BAHAMONDE VICENTE (CHI)
7. BELFAND PAUL (USA)
7. SALGADO RUEDA DIEGO (MEX)

Referees:			

Pool winner-Cadet Kumite Male -52 kg

Karate1 Youth League - Cancun 2024, Iberostar Playa Paraíso Convention Center, Avenida del Sol Km 309, Playa Paraiso, 77710 Riviera Maya, MEX

Tatami

Pool

1/1

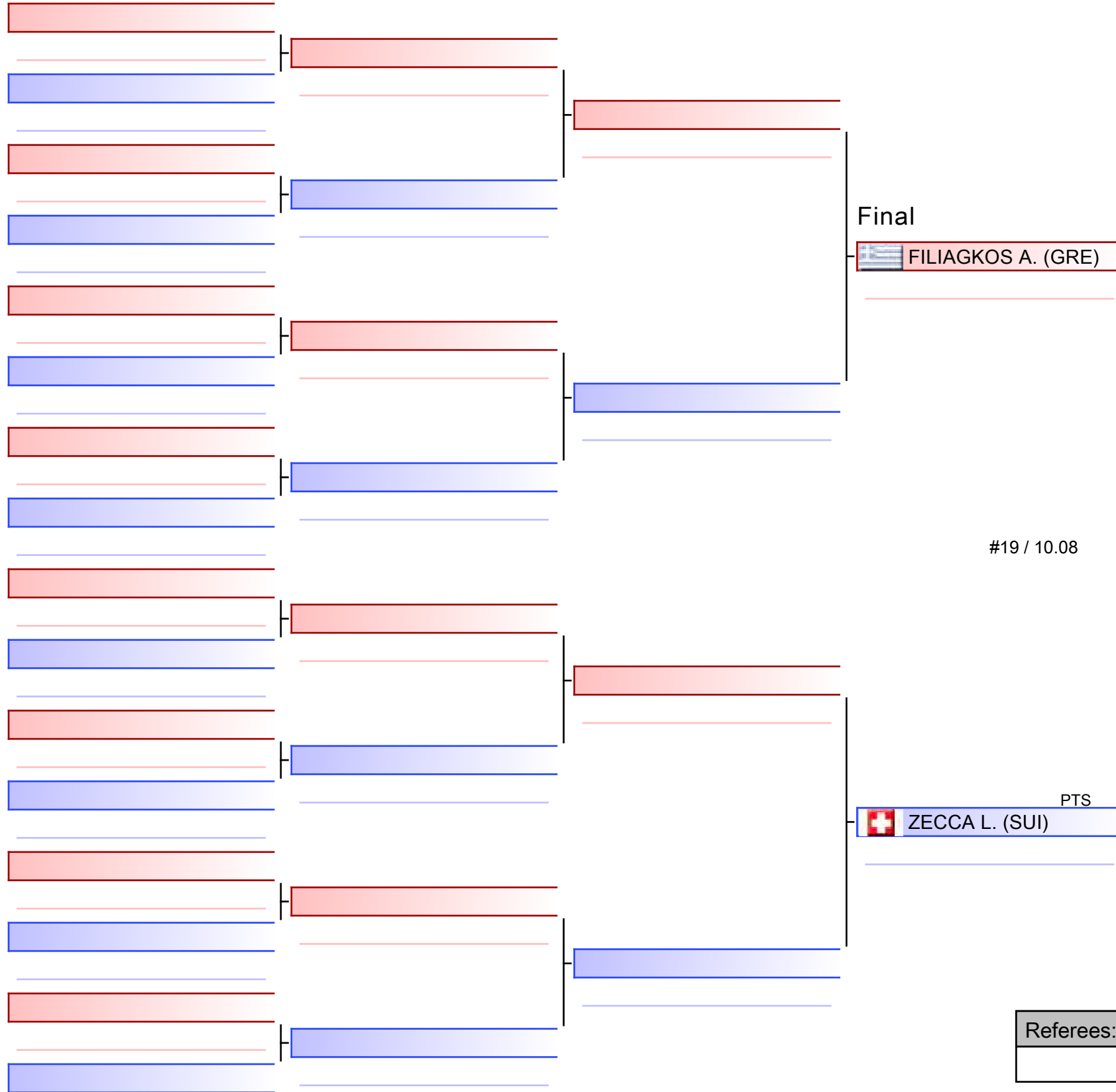

1. ZECCA LUCAS (SUI)
2. FILIAGKOS ATHANASIOS (GRE)
3. GUEVARA VALDEZ DANIEL ALEJANDRO (MEX)
3. PETAGNA LOPEZ PAOLO (ESP)
5. NUNEZ AARON (USA)
5. SANCHEZ BAHAMONDE VICENTE (CHI)
7. BELFAND PAUL (USA)
7. SALGADO RUEDA DIEGO (MEX)

Referees:			

Cadet Kumite Male -52 kg

Karate1 Youth League - Cancun 2024

2024-08-10

Tatami
3 12:20

Pool
1,2

(c)sportdata GmbH & Co KG 2000-2024 (2024-08-11 14:41) v 10.2.0 build 1 (2024-08-09 20:34 CET) License: Online_Event_ID-875_Karate1YouthLeagueCancun2024 (expire 2024-08-25)

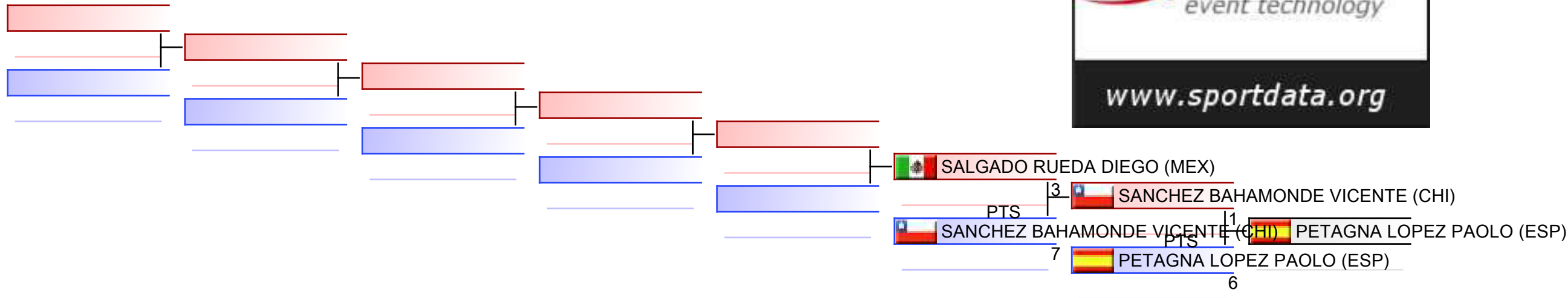

REPECHAGE: (1,2)

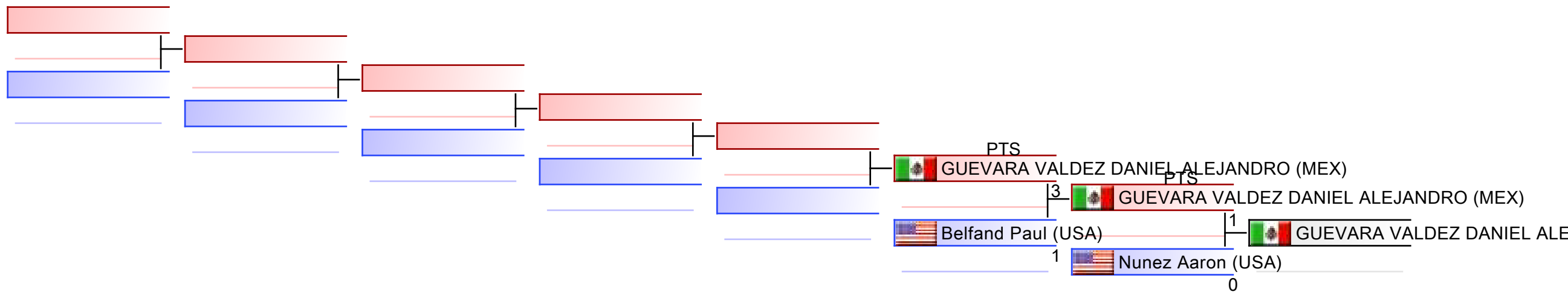

Referees:							
-----------	--	--	--	--	--	--	--



Karate1 Youth League - Cancun 2024 - 2024-08-08



Official Results

Cadet Kumite Male -52 kg			
1	ZECCA LUCAS		SUI - SWITZERLAND
2	FILIAGKOS ATHANASIOS		GRE - GREECE
3	GUEVARA VALDEZ DANIEL ALEJANDRO		MEX - MEXICO
3	PETAGNA LOPEZ PAOLO		ESP - SPAIN
5	NUNEZ AARON		USA - UNITED STATES
5	SANCHEZ BAHAMONDE VICENTE		CHI - CHILE
7	BELFAND PAUL		USA - UNITED STATES
7	SALGADO RUEDA DIEGO		MEX - MEXICO

CADET KUMITE MALE -57 KG



Karate1 Youth League - Cancun 2024
ENTRIES BY WEIGHT CATEGORY



Cadet Kumite Male -57 kg
As of 11 AUG 2024

NOC Code	Gender	Name	Seeding
CHI	M	Carrera Rubilar Lucian	
CHI	M	LOBOS MACEDO RODRIGO	
COL	M	cifuentes munar giancarlo	
CRC	M	RODESNO DANIEL	
GER	M	Hoerner Paul-Willibald	
JAM	M	EVANS RASANDRE VALENTINO	
MEX	M	BOJORQUEZ BRITO EDWARD ADRIAN	
MEX	M	GARCIA RODRIGUEZ ELIHU EMMANUEL	
MEX	M	PEREZ LOPEZ SANTIAGO	
MEX	M	RANGEL RANGEL GUSTAVO	
MEX	M	SIXTO GARCIA IZEL OCELOTL	
MEX	M	YOSHII MIZUKAMI KAITO DANIEL	
PER	M	Correa Berru Thiago Mathias	
POR	M	Teixeira Pena André Filipe	
PUR	M	Almodovar Marin Diego	
SUI	M	Patricio-Clément Johan	

Cadet Kumite Male -57 kg

Karate1 Youth League - Cancun 2024, Iberostar Playa Paraíso Convention Center, Avenida del Sol Km 309, Playa Paraiso, 77710 Riviera Maya, MEX

2024-08-10

Tatami
4 12:15

Pool
1/1

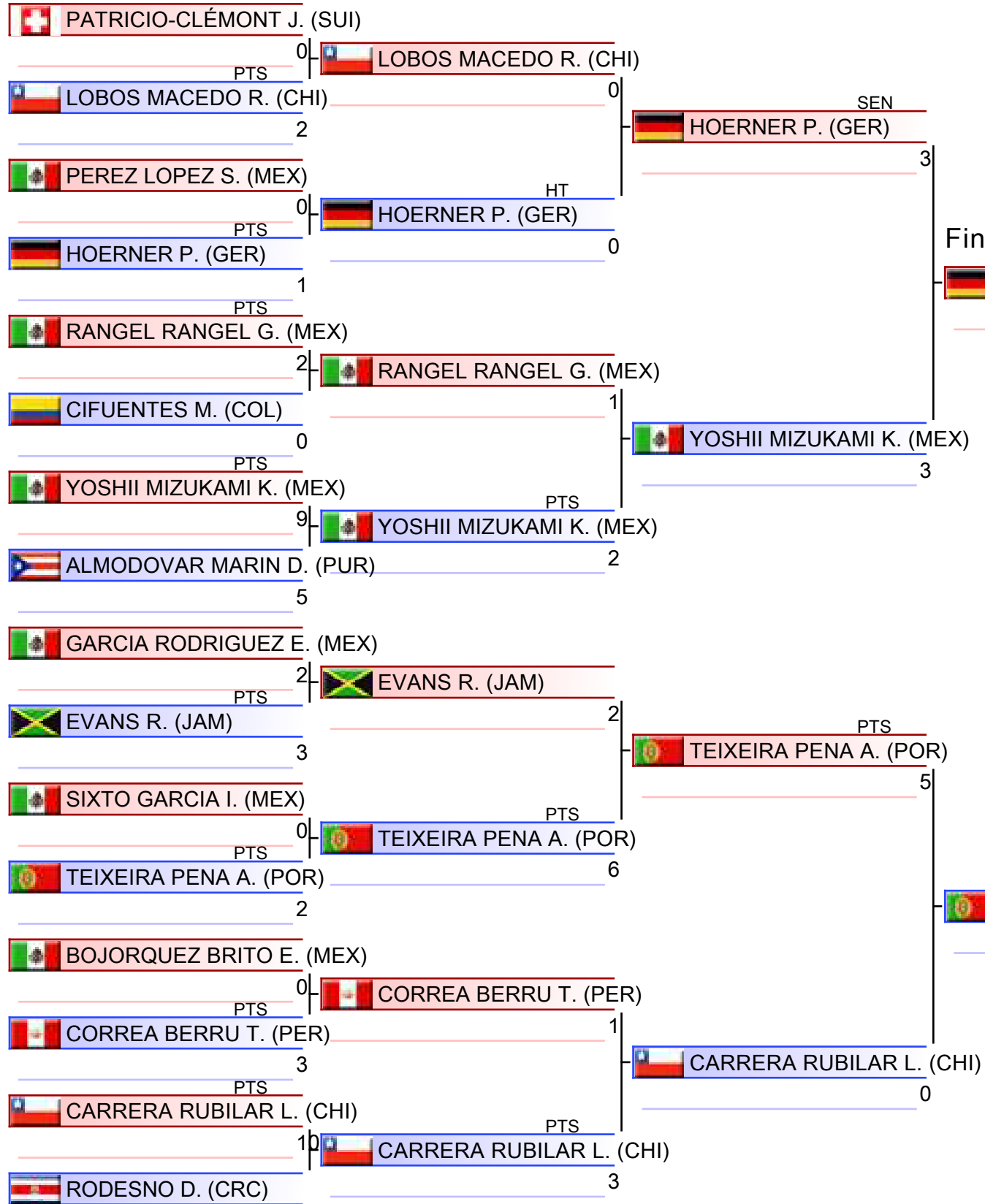

1. HOERNER PAUL-WILLIBALD (GER)
2. TEIXEIRA PENA ANDRÉ FILIPE (POR)
3. LOBOS MACEDO RODRIGO (CHI)
3. CARRERA RUBILAR LUCIAN (CHI)
5. YOSHII MIZUKAMI KAITO DANIEL (MEX)
5. SIXTO GARCIA IZEL OCELOTL (MEX)
7. PEREZ LOPEZ SANTIAGO (MEX)
7. EVANS RASANDRE VALENTINO (JAM)

Referees:			

Cadet Kumite Male -57 kg

Karate1 Youth League - Cancun 2024

2024-08-10

Tatami
4 13:25

Pool
1

(c)sportdata GmbH & Co KG 2000-2024 (2024-08-11 14:41) v 10.2.0 build 1 (2024-08-09 20:34 CET) License: Online_Event_ID-875_Karate1YouthLeagueCancun2024 (expire 2024-08-25)

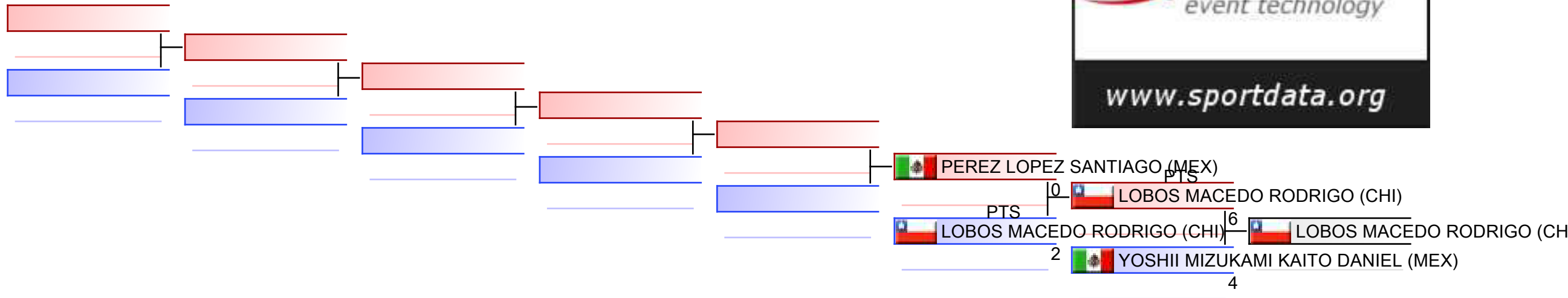

REPECHAGE: (1)

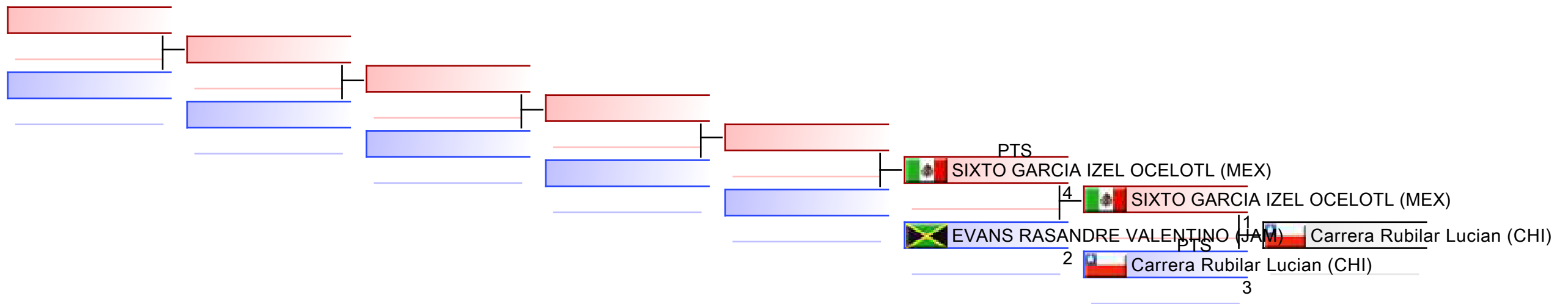

Referees:							
-----------	--	--	--	--	--	--	--



Karate1 Youth League - Cancun 2024 - 2024-08-08



Official Results

Cadet Kumite Male -57 kg			
1	HOERNER PAUL-WILLIBALD		GER - GERMANY
2	TEIXEIRA PENA ANDRÉ FILIPE		POR - PORTUGAL
3	LOBOS MACEDO RODRIGO		CHI - CHILE
3	CARRERA RUBILAR LUCIAN		CHI - CHILE
5	YOSHII MIZUKAMI KAITO DANIEL		MEX - MEXICO
5	SIXTO GARCIA IZEL OCELOTL		MEX - MEXICO
7	PEREZ LOPEZ SANTIAGO		MEX - MEXICO
7	EVANS RASANDRE VALENTINO		JAM - JAMAICA

CADET KUMITE MALE -63 KG



Karate1 Youth League - Cancun 2024
ENTRIES BY WEIGHT CATEGORY



Cadet Kumite Male -63 kg
As of 11 AUG 2024

NOC Code	Gender	Name	Seeding
CHI	M	ARRIAGADA PAVEZ INAKI	
CHI	M	Macchiavello Ramírez Piero Alessandro	
CRC	M	MURILLO DERECK	
CRC	M	RIVERA FABRICIO	
CRC	M	RODRIGUEZ SANTIAGO	
GER	M	Niederelz Tim	
GUA	M	FLORES ORTIZ JORGE DAMIAN	
IND	M	Agrawal Abhirraj	
LUX	M	Todorovic Filip	
MEX	M	CERVANTES BANDA SEBASTIAN	
MEX	M	GALAVIZ GALAVIZ JORGE ERUBIEL	
MEX	M	GARCÍA MENESES IGNACIO SALVADOR	
MEX	M	GARZA VIZCAINO JOSE SANTIAGO	
MEX	M	HIGUERA ROMERO Carlos Francisco	
MEX	M	RIVERO ARJONA DAYRON FERNANDO	
PER	M	Arosquipa Quispe Wilbert	
PER	M	LAVADO ROJAS VALENTINO YAEL	
PUR	M	Rivera Rivera Ricardo Jeniel	
USA	M	Farris Logan	
USA	M	WILSON TAVERAS	
VEN	M	De Abreu De Abreu Santiago	
VEN	M	LUCAS MUJICA TOMAS	

Cadet Kumite Male -63 kg

Karate1 Youth League - Cancun 2024, Iberostar Playa Paraíso Convention Center, Avenida del Sol Km 309, Playa Paraiso, 77710 Riviera Maya, MEX

2024-08-10

Tatami
1 14:00

Pool
1/2

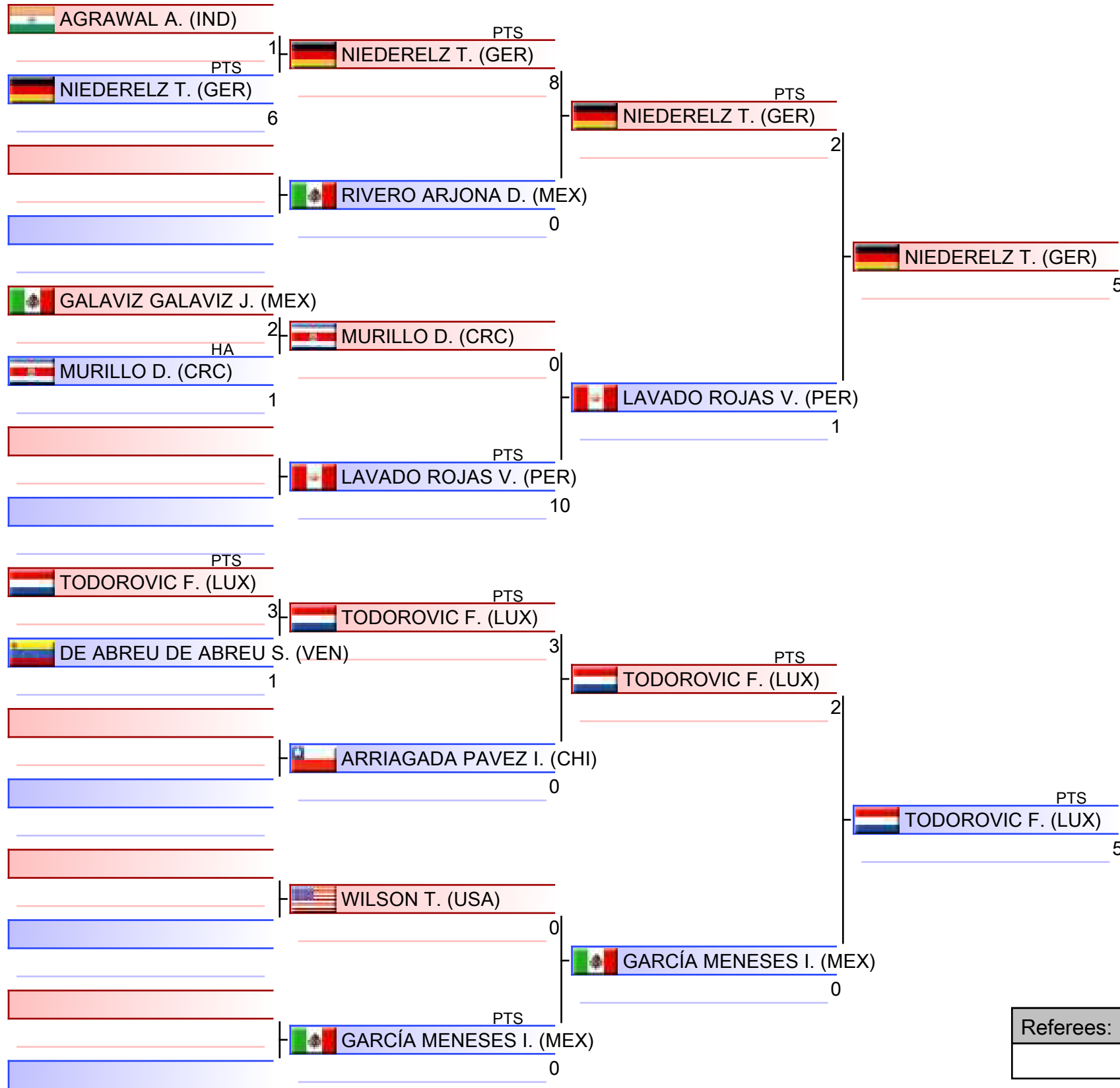

1. TODOROVIC FILIP (LUX)
2. RIVERA RIVERA RICARDO JENIEL (PUR)
3. NIEDERELZ TIM (GER)
3. FARRIS LOGAN (USA)
5. DE ABREU DE ABREU SANTIAGO (VEN)
5. FLORES ORTIZ JORGE DAMIAN (GUA)
7. GARCÍA MENESES IGNACIO SALVADOR (MEX)
7. RODRIGUEZ SANTIAGO (CRC)

Referees:			

Cadet Kumite Male -63 kg

Karate1 Youth League - Cancun 2024, Iberostar Playa Paraíso Convention Center, Avenida del Sol Km 309, Playa Paraiso, 77710 Riviera Maya, MEX

2024-08-10

Tatami

2 13:30

Pool

2/2

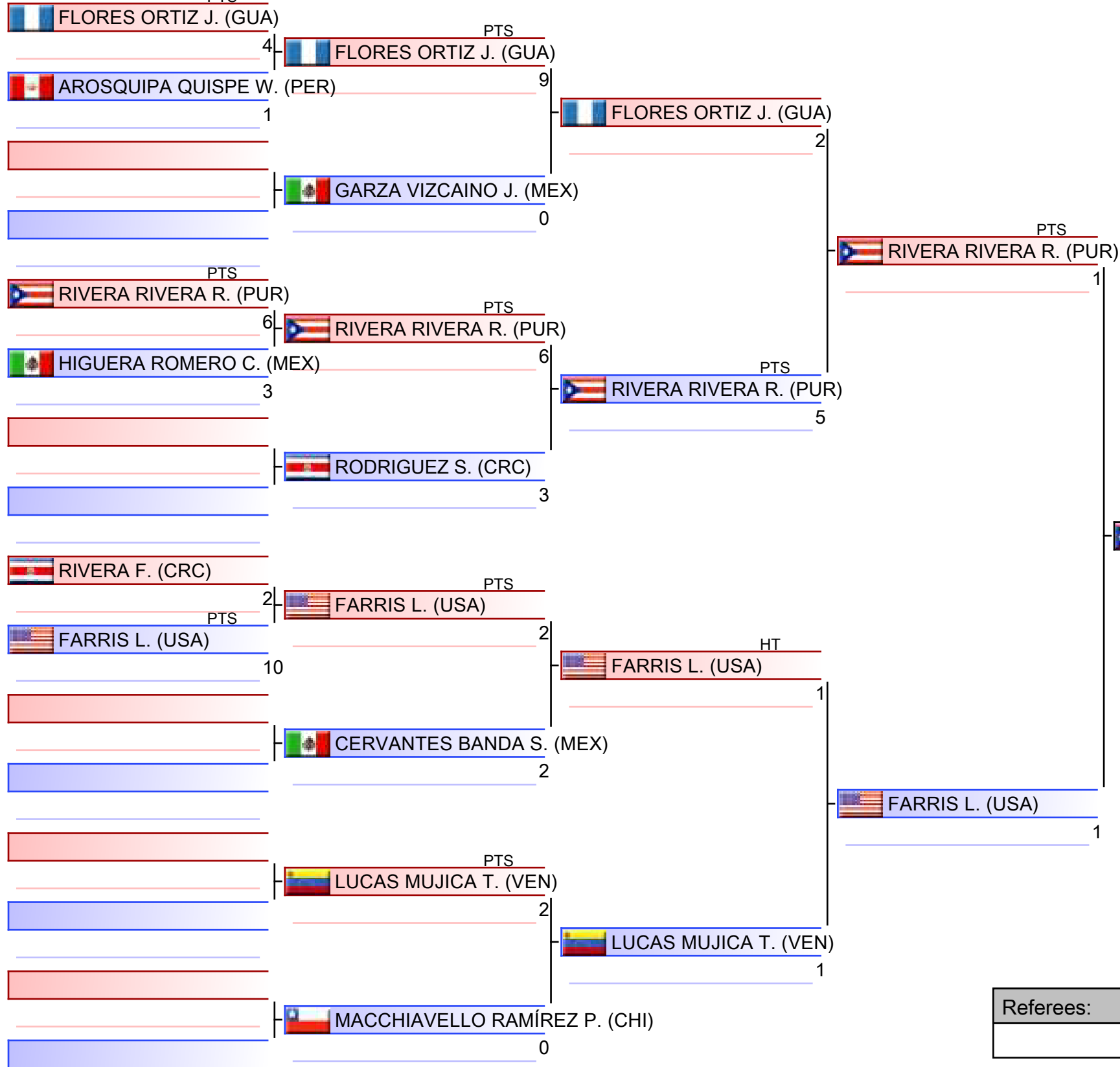

1. TODOROVIC FILIP (LUX)
2. RIVERA RIVERA RICARDO JENIEL (PUR)
3. NIEDERELZ TIM (GER)
3. FARRIS LOGAN (USA)
5. DE ABREU DE ABREU SANTIAGO (VEN)
5. FLORES ORTIZ JORGE DAMIAN (GUA)
7. GARCÍA MENESES IGNACIO SALVADOR (MEX)
7. RODRIGUEZ SANTIAGO (CRC)

Referees:			

Pool winner-Cadet Kumite Male -63 kg

Karate1 Youth League - Cancun 2024, Iberostar Playa Paraíso Convention Center, Avenida del Sol Km 309, Playa Paraiso, 77710 Riviera Maya, MEX

Tatami

Pool

1/1

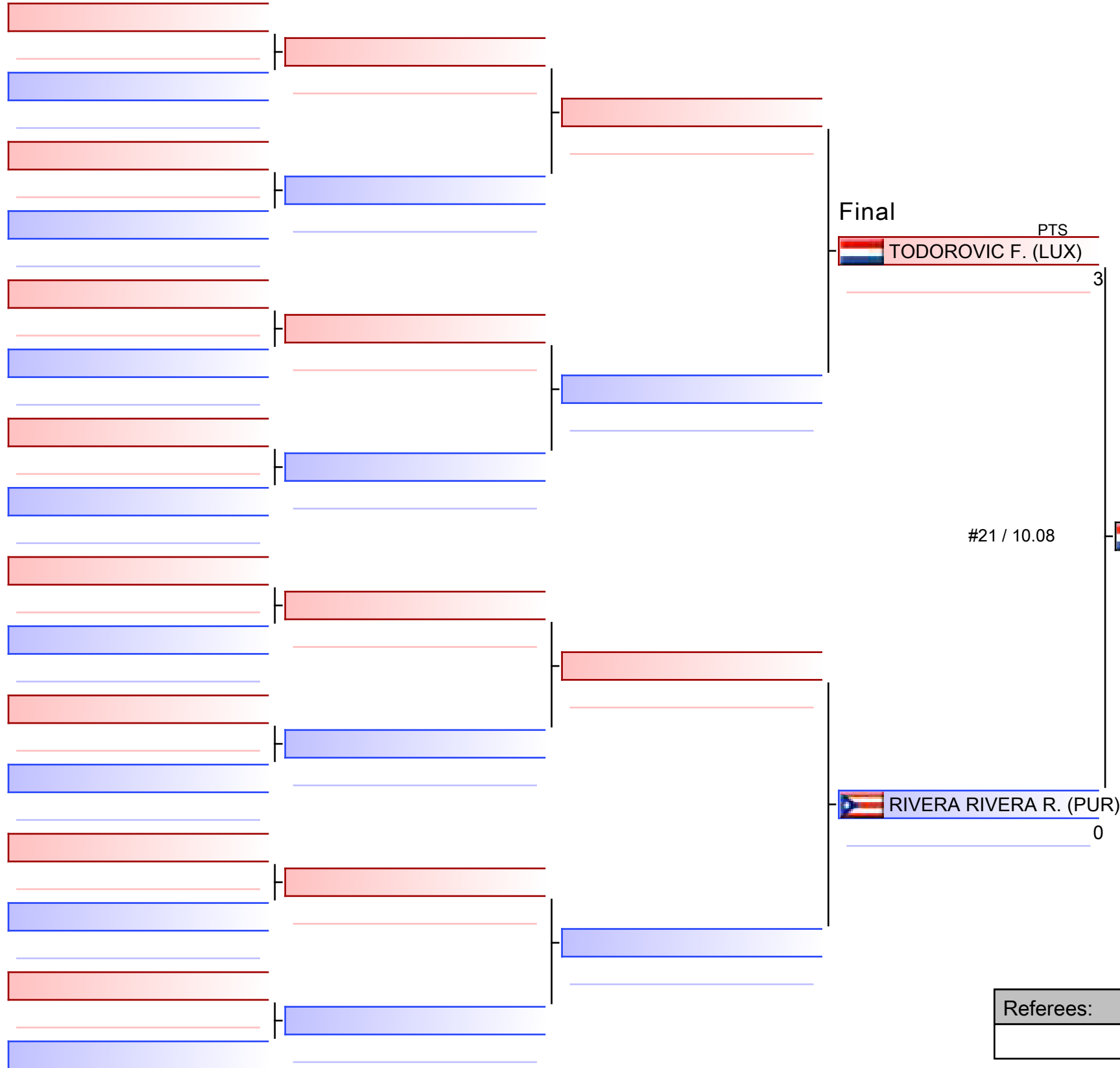

- | |
|--|
| 1. TODOROVIC FILIP (LUX) |
| 2. RIVERA RIVERA RICARDO JENIEL (PUR) |
| 3. NIEDERELZ TIM (GER) |
| 3. FARRIS LOGAN (USA) |
| 5. DE ABREU DE ABREU SANTIAGO (VEN) |
| 5. FLORES ORTIZ JORGE DAMIAN (GUA) |
| 7. GARCÍA MENESES IGNACIO SALVADOR (MEX) |
| 7. RODRIGUEZ SANTIAGO (CRC) |

Referees:			

Cadet Kumite Male -63 kg

Karate1 Youth League - Cancun 2024

2024-08-10

Tatami
1 14:50

Pool
1

(c)sportdata GmbH & Co KG 2000-2024 (2024-08-11 14:41) v 10.2.0 build 1 (2024-08-09 20:34 CET) License: Online_Event_ID-875_Karate1YouthLeagueCancun2024 (expire 2024-08-25)

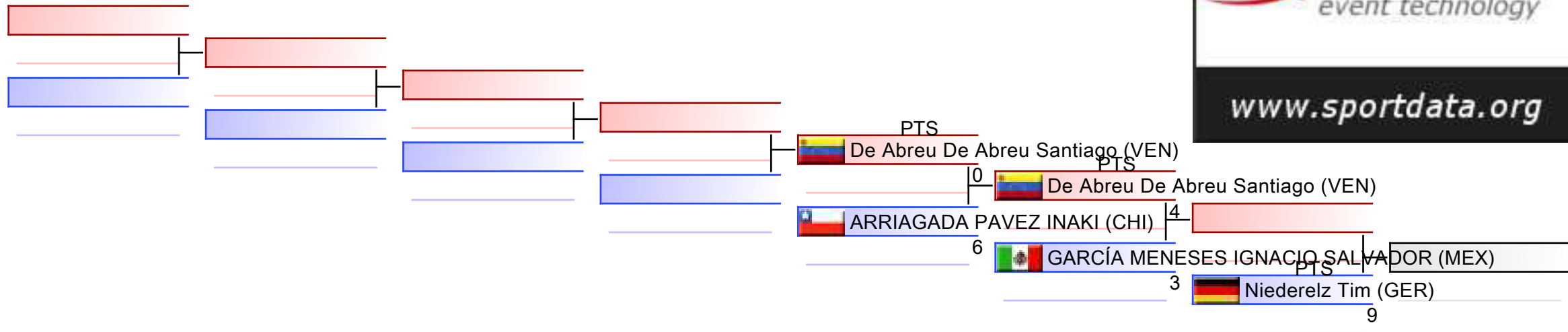

REPECHAGE: (1)

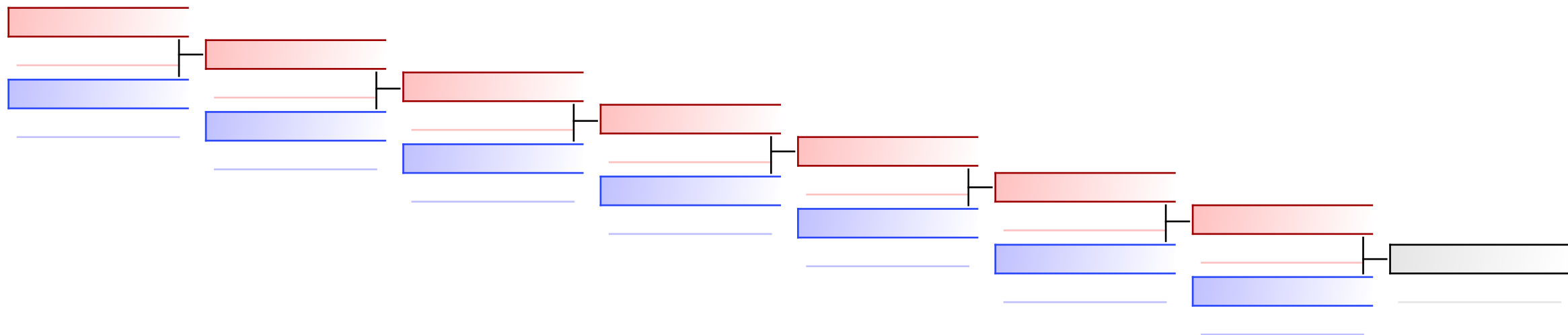

Referees:							
-----------	--	--	--	--	--	--	--

Cadet Kumite Male -63 kg

Karate1 Youth League - Cancun 2024

2024-08-10

Tatami
1 14:50

Pool
1,2

(c)sportdata GmbH & Co KG 2000-2024 (2024-08-11 14:41) v 10.2.0 build 1 (2024-08-09 20:34 CET) License: Online_Event_ID-875_Karate1YouthLeagueCancun2024 (expire 2024-08-25)

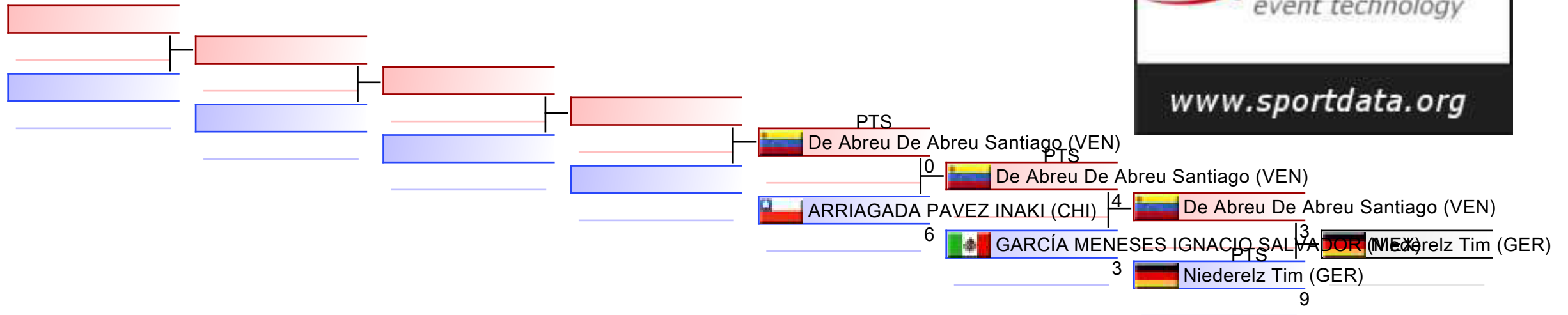

REPECHAGE: (1,2)

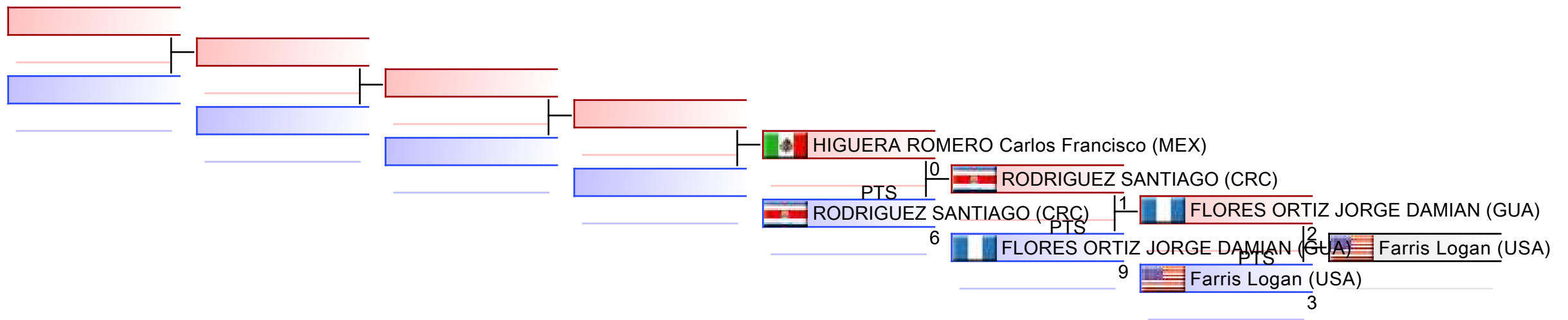

Referees:							
-----------	--	--	--	--	--	--	--



Karate1 Youth League - Cancun 2024 - 2024-08-08



Official Results

Cadet Kumite Male -63 kg			
1	TODOROVIC FILIP		LUX - LUXEMBOURG
2	RIVERA RIVERA RICARDO JENIEL		PUR - PUERTO RICO
3	NIEDERELZ TIM		GER - GERMANY
3	FARRIS LOGAN		USA - UNITED STATES
5	DE ABREU DE ABREU SANTIAGO		VEN - VENEZUELA
5	FLORES ORTIZ JORGE DAMIAN		GUA - GUATEMALA
7	GARCÍA MENESES IGNACIO SALVADOR		MEX - MEXICO
7	RODRIGUEZ SANTIAGO		CRC - COSTA RICA
9	ARRIAGADA PAVEZ INAKI		CHI - CHILE
9	HIGUERA ROMERO CARLOS FRANCISCO		MEX - MEXICO

CADET KUMITE MALE -70 KG



Karate1 Youth League - Cancun 2024
ENTRIES BY WEIGHT CATEGORY



Cadet Kumite Male -70 kg
As of 11 AUG 2024

NOC Code	Gender	Name	Seeding
CAN	M	CRONJE JINICHI	
CHI	M	CARRENO OLAVARRIA VICENTE	
CHI	M	MUÑOZ CONTRERAS SEBASTIAN	
COL	M	TORDECILLA FELIPE	
CRC	M	BONILLAS NICOLAS	
CRC	M	JIMENEZ MATIAS	
CRC	M	MEJIA SEBASTIAN	
CRO	M	SLUKIC PETAR	
CZE	M	Šťáhlavský David	
MEX	M	JANDA KOBROVA DOMINIK	
MEX	M	LOPEZ IBARRA EDER RENE	
MEX	M	MOJICA SOTO IAN NICKOLAS	
PAR	M	ALCARAZ LEANDRO	
PER	M	ASALDE MENDOZA PABLO EMMANUEL	
USA	M	Davila Martin	
USA	M	Nguyen Andersen	
VEN	M	VALERO JESUS	

Cadet Kumite Male -70 kg

Karate1 Youth League - Cancun 2024, Iberostar Playa Paraíso Convention Center, Avenida del Sol Km 309, Playa Paraiso, 77710 Riviera Maya, MEX

2024-08-10

Tatami
3 14:15

Pool
1/2

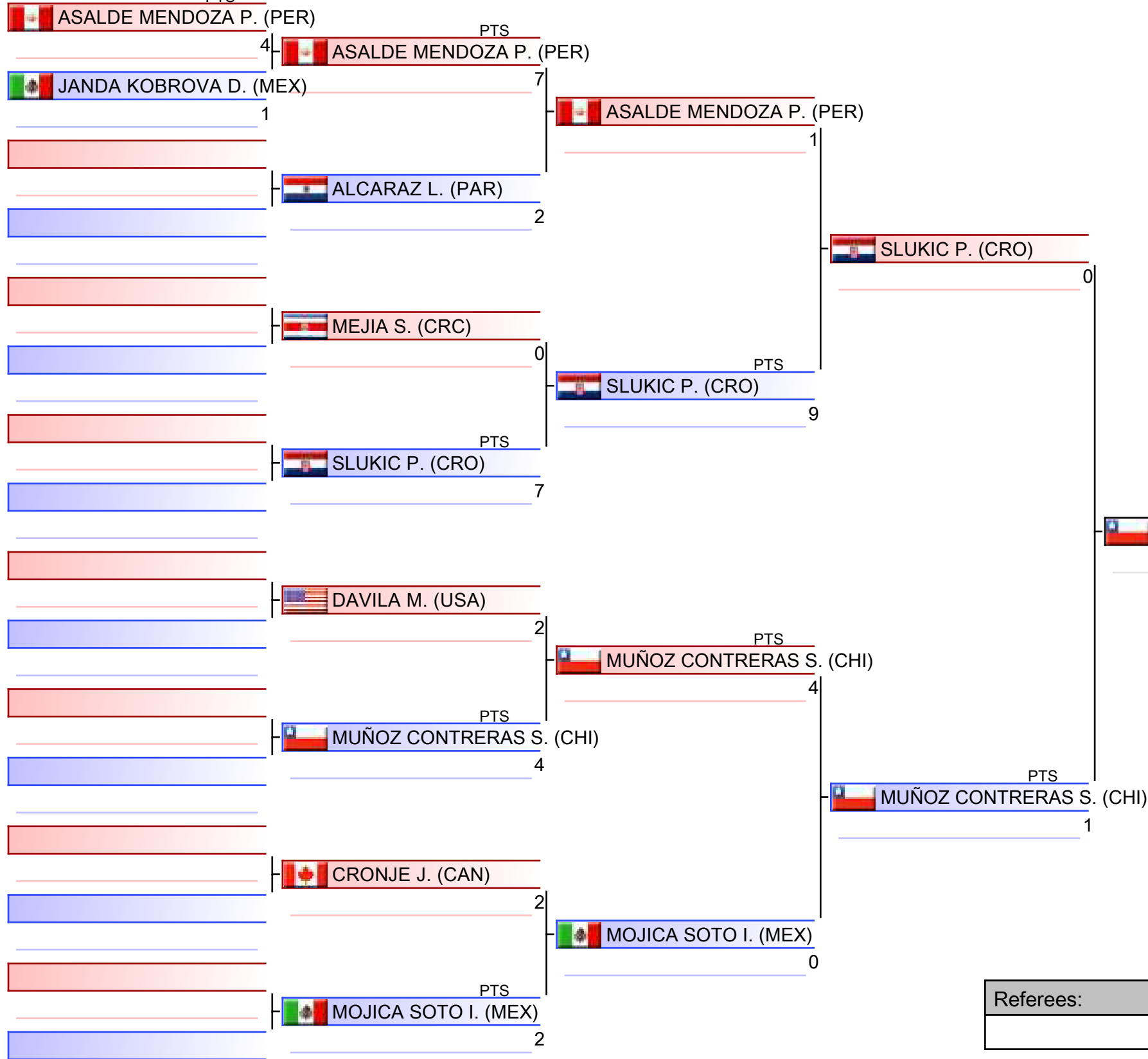

1. VALERO JESUS (VEN)
2. MUÑOZ CONTRERAS SEBASTIAN (CHI)
3. CARRENO OLAVARRIA VICENTE (CHI)
3. SLUKIC PETAR (CRO)
5. JIMENEZ MATIAS (CRC)
5. DAVILA MARTIN (USA)
7. TORDECILLA FELIPE (COL)
7. MOJICA SOTO IAN NICKOLAS (MEX)

Referees:			

Cadet Kumite Male -70 kg

Karate1 Youth League - Cancun 2024, Iberostar Playa Paraíso Convention Center, Avenida del Sol Km 309, Playa Paraiso, 77710 Riviera Maya, MEX

2024-08-10

Tatami
2 14:20

Pool
2/2

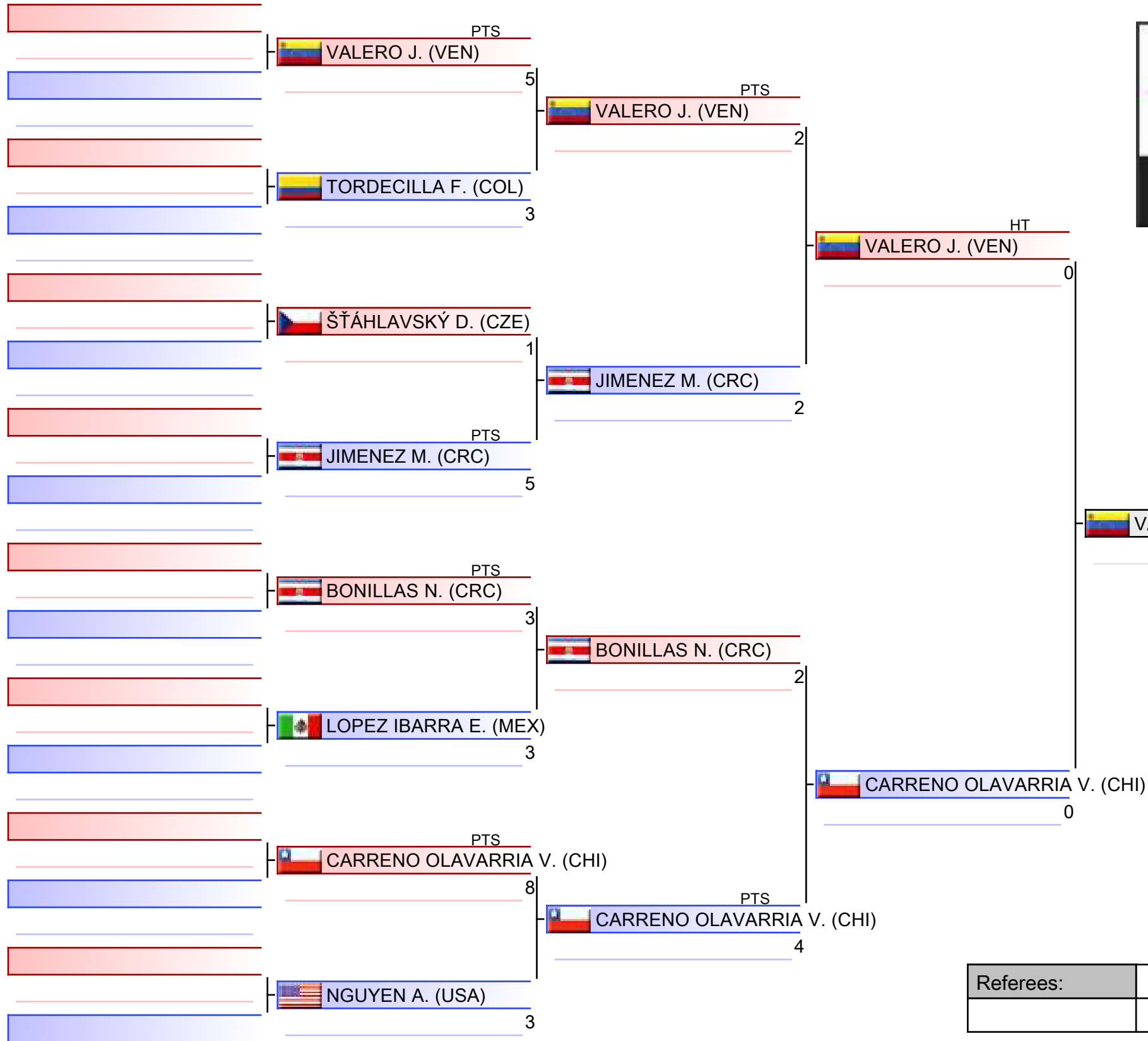

1. VALERO JESUS (VEN)
2. MUÑOZ CONTRERAS SEBASTIAN (CHI)
3. CARRENO OLAVARRIA VICENTE (CHI)
3. SLUKIC PETAR (CRO)
5. JIMENEZ MATIAS (CRC)
5. DAVILA MARTIN (USA)
7. TORDECILLA FELIPE (COL)
7. MOJICA SOTO IAN NICKOLAS (MEX)

Referees:			

Pool winner-Cadet Kumite Male -70 kg

Karate1 Youth League - Cancun 2024, Iberostar Playa Paraíso Convention Center, Avenida del Sol Km 309, Playa Paraiso, 77710 Riviera Maya, MEX

Tatami

Pool

1/1

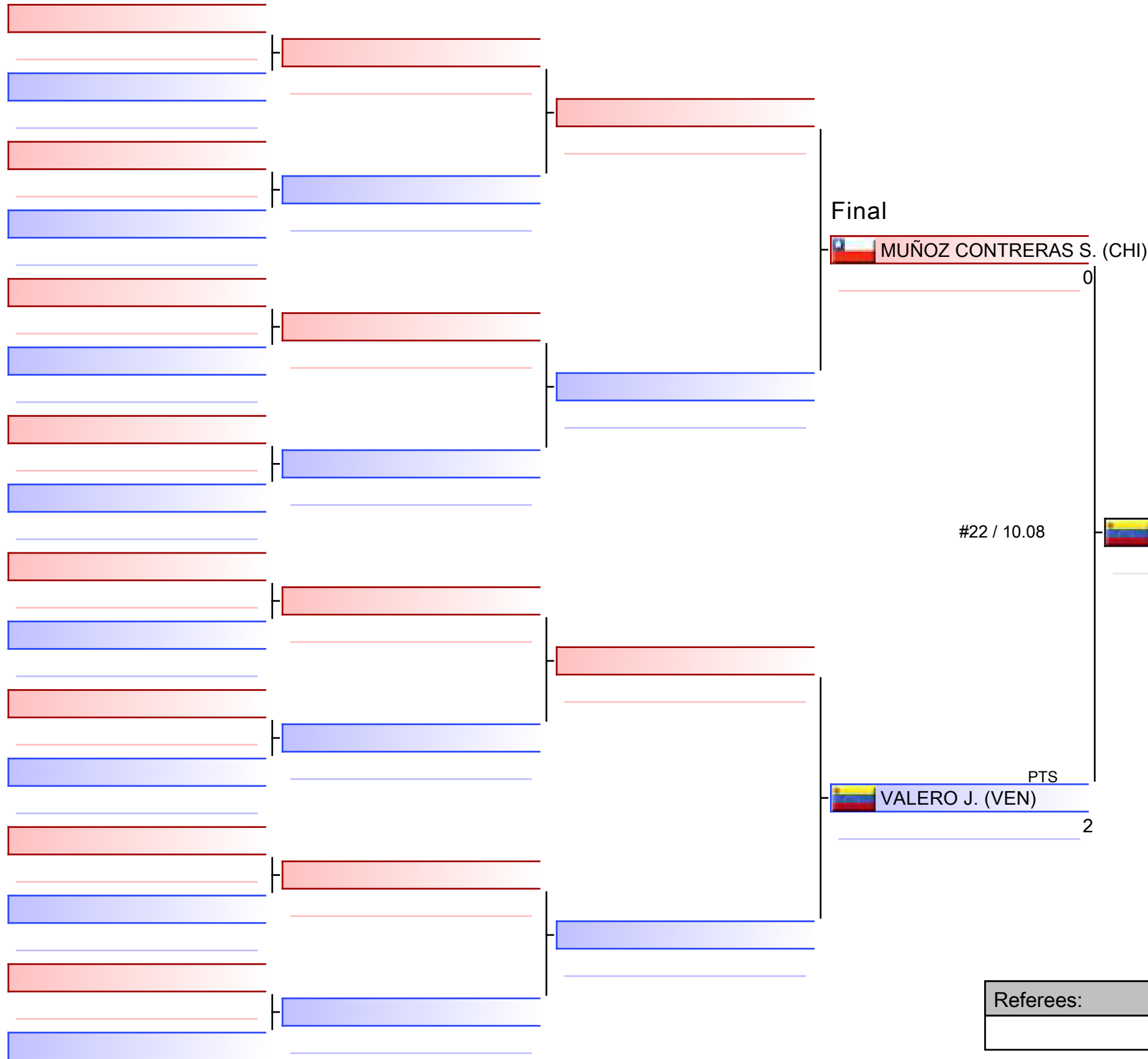

1. VALERO JESUS (VEN)
2. MUÑOZ CONTRERAS SEBASTIAN (CHI)
3. CARRENO OLAVARRIA VICENTE (CHI)
3. SLUKIC PETAR (CRO)
5. JIMENEZ MATIAS (CRC)
5. DAVILA MARTIN (USA)
7. TORDECILLA FELIPE (COL)
7. MOJICA SOTO IAN NICKOLAS (MEX)

Referees:			

Cadet Kumite Male -70 kg

Karate1 Youth League - Cancun 2024

2024-08-10

Tatami
3 14:55

Pool
1

(c)sportdata GmbH & Co KG 2000-2024 (2024-08-11 14:41) v 10.2.0 build 1 (2024-08-09 20:34 CET) License: Online_Event_ID-875_Karate1YouthLeagueCancun2024 (expire 2024-08-25)

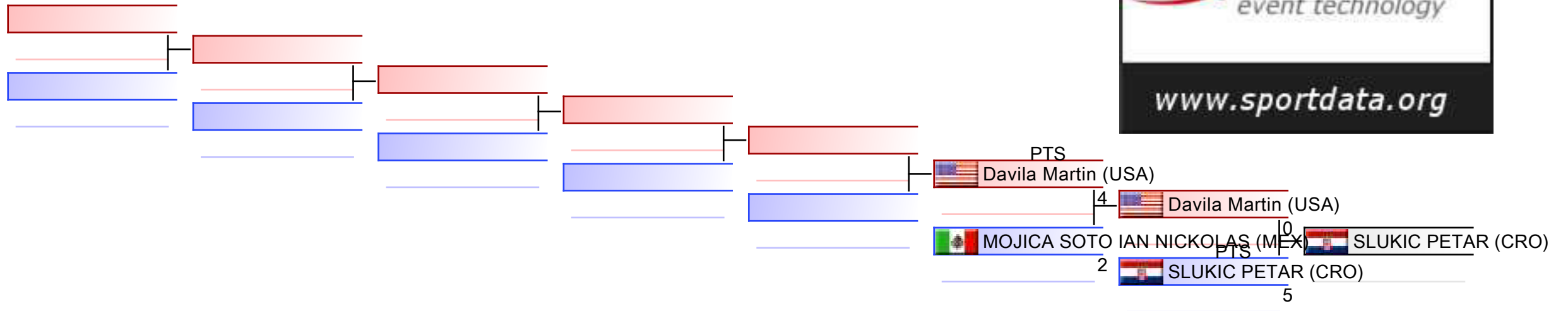

REPECHAGE: (1)

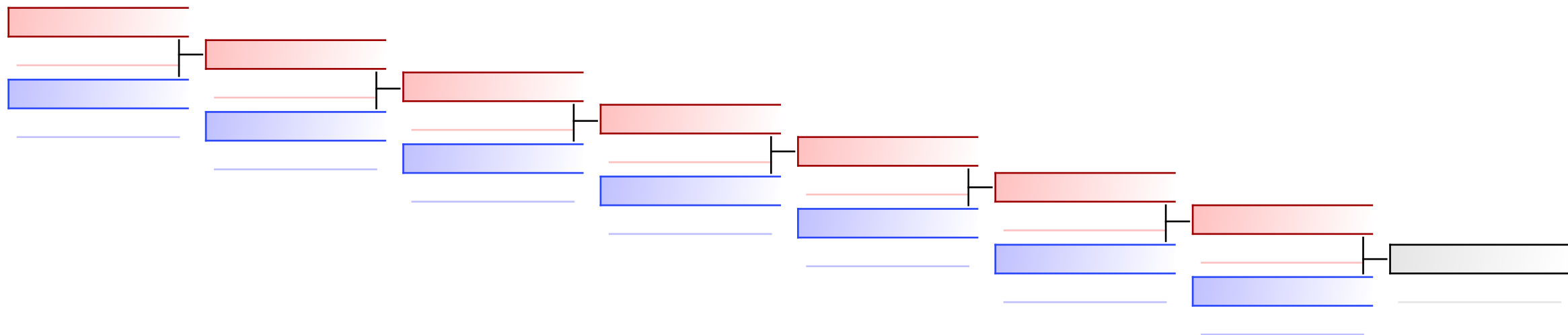

Referees:							
-----------	--	--	--	--	--	--	--

Cadet Kumite Male -70 kg

Karate1 Youth League - Cancun 2024

2024-08-10

Tatami
2 14:55

Pool
2

(c)sportdata GmbH & Co KG 2000-2024 (2024-08-11 14:41) v 10.2.0 build 1 (2024-08-09 20:34 CET) License: Online_Event_ID-875_Karate1YouthLeagueCancun2024 (expire 2024-08-25)

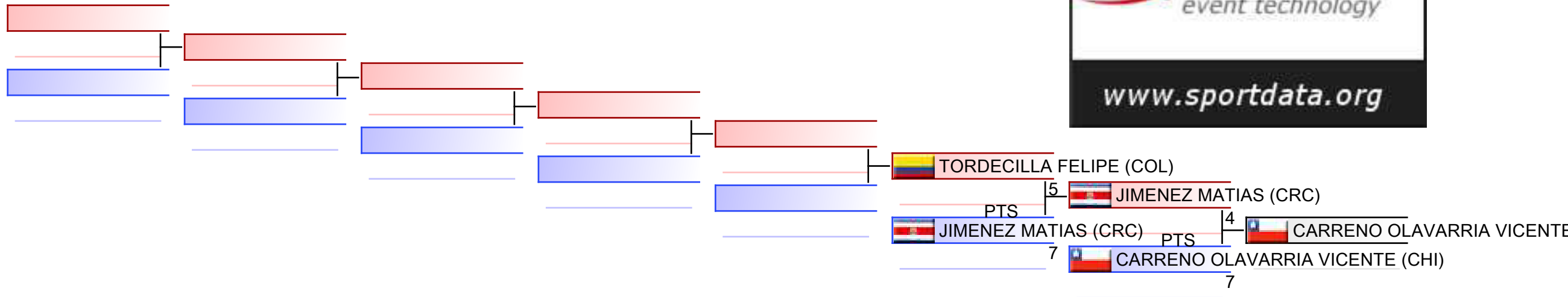

REPECHAGE: (2)

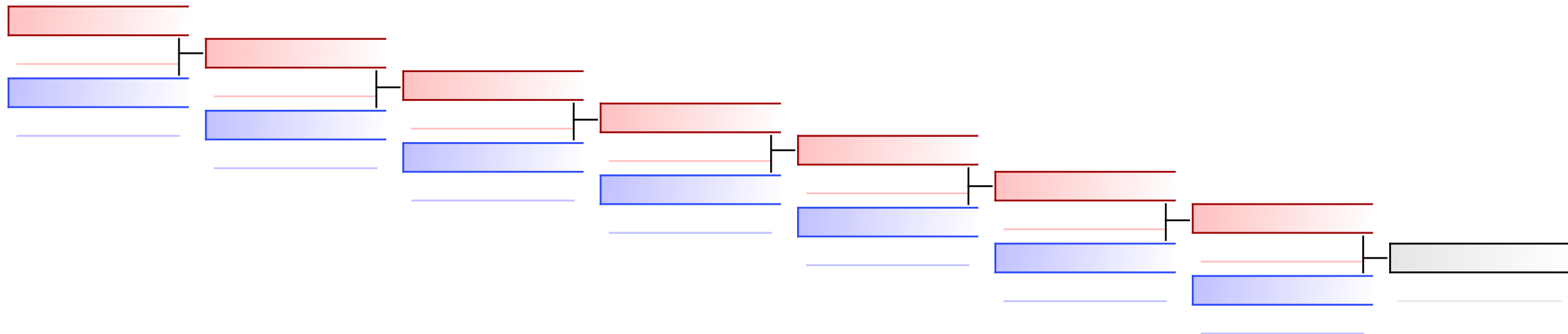

Referees:							
-----------	--	--	--	--	--	--	--



Karate1 Youth League - Cancun 2024 - 2024-08-08



Official Results

Cadet Kumite Male -70 kg			
1	VALERO JESUS		VEN - VENEZUELA
2	MUNOZ CONTRERAS SEBASTIAN		CHI - CHILE
3	CARRENO OLAVARRIA VICENTE		CHI - CHILE
3	SLUKIC PETAR		CRO - CROATIA
5	JIMENEZ MATIAS		CRC - COSTA RICA
5	DAVILA MARTIN		USA - UNITED STATES
7	TORDECILLA FELIPE		COL - COLOMBIA
7	MOJICA SOTO IAN NICKOLAS		MEX - MEXICO

CADET KUMITE MALE 70+ KG



Karate1 Youth League - Cancun 2024
ENTRIES BY WEIGHT CATEGORY



Cadet Kumite Male 70+ kg
As of 11 AUG 2024

NOC Code	Gender	Name	Seeding
CHI	M	Concha Sepulveda Jorge	
CRO	M	SOLTIC ERVIN	
ESP	M	Mazo Marco	
FRA	M	Adjanonhoun Ihsane	
GUA	M	ROLDAN REYNA JOSE MIGUEL	
MEX	M	CAMPOS DESCIDERIO GENCO ANDRE	
MEX	M	PERERA TAMAY CHRISTOPHER JESUS	
MEX	M	PEREZ GUTIERREZ MARCO ANTONIO	
MEX	M	REYNA CANO ORLANDO	
MEX	M	VALERO HERNANDEZ ERIK ALEJANDRO	
SVK	M	Mitrik Richard	
USA	M	Jackson Isaiah	

Cadet Kumite Male 70+ kg

Karate1 Youth League - Cancun 2024, Iberostar Playa Paraíso Convention Center, Avenida del Sol Km 309, Playa Paraiso, 77710 Riviera Maya, MEX

2024-08-10

Tatami
4 13:45

Pool
1/1

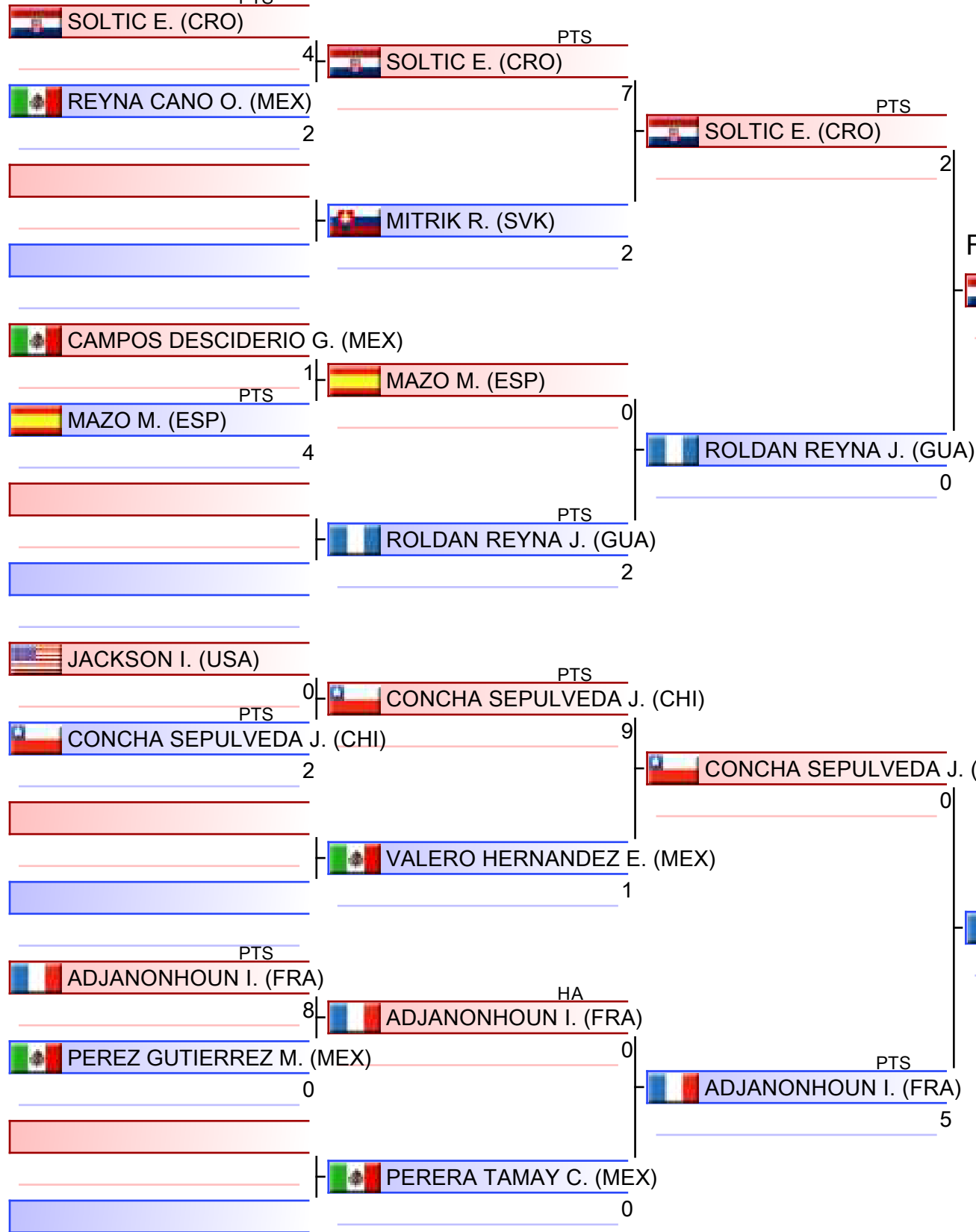

1. ADJANONHOUN IHSANE (FRA)
2. SOLTIC ERVIN (CRO)
3. PEREZ GUTIERREZ MARCO ANTONIO (MEX)
3. MITRIK RICHARD (SVK)
5. CONCHA SEPULVEDA JORGE (CHI)
5. ROLDAN REYNA JOSE MIGUEL (GUA)
7. PERERA TAMAY CHRISTOPHER JESUS (MEX)
7. REYNA CANO ORLANDO (MEX)

Referees:			

Cadet Kumite Male 70+ kg

Karate1 Youth League - Cancun 2024

2024-08-10

Tatami
4 14:35

Pool
1

(c)sportdata GmbH & Co KG 2000-2024 (2024-08-11 14:41) v 10.2.0 build 1 (2024-08-09 20:34 CET) License: Online_Event_ID-875_Karate1YouthLeagueCancun2024 (expire 2024-08-25)

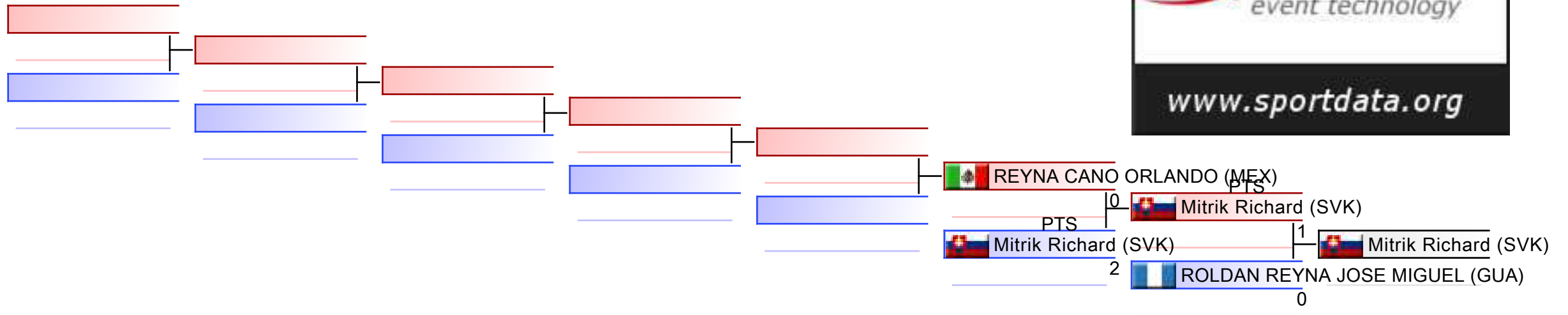

REPECHAGE: (1)

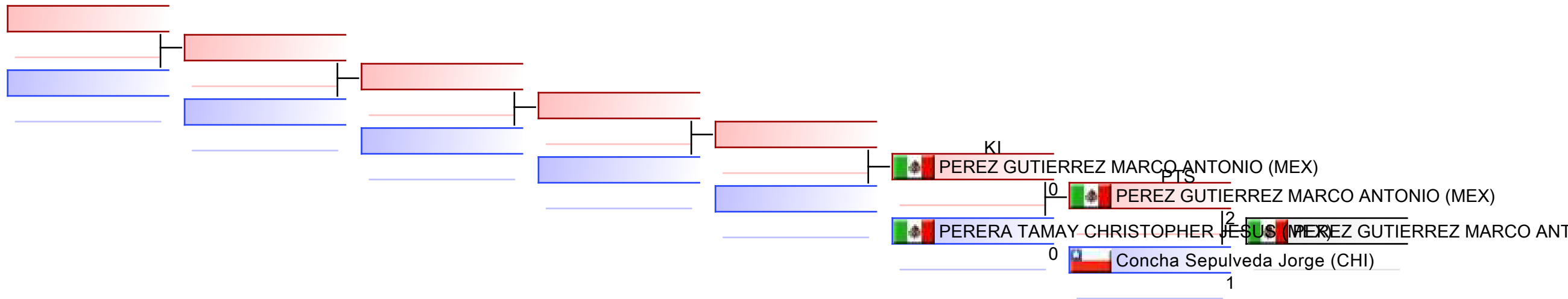

Referees:							
-----------	--	--	--	--	--	--	--



Karate1 Youth League - Cancun 2024 - 2024-08-08



Official Results

Cadet Kumite Male 70+ kg			
1	ADJANONHOUN IHSANE		FRA - FRANCE
2	SOLTIC ERVIN		CRO - CROATIA
3	PEREZ GUTIERREZ MARCO ANTONIO		MEX - MEXICO
3	MITRIK RICHARD		SVK - SLOVAKIA
5	CONCHA SEPULVEDA JORGE		CHI - CHILE
5	ROLDAN REYNA JOSE MIGUEL		GUA - GUATEMALA
7	PERERA TAMAY CHRISTOPHER JESUS		MEX - MEXICO
7	REYNA CANO ORLANDO		MEX - MEXICO

JUNIOR KATA FEMALE



Karate1 Youth League - Cancun 2024
ENTRIES BY WEIGHT CATEGORY



Junior Kata Female
As of 11 AUG 2024

NOC Code	Gender	Name	Seeding
BRA	F	Collela Yasmin	
CAN	F	Lee Amanda	
COL	F	cardona grajales sara	
CRC	F	CALVO ARIELA	
CRC	F	FERRETO JIMENEZ ANGHELINA	
ESA	F	CERROS ELENA ISABEL	
FRA	F	BUI Mai-Linh	
ITA	F	ederar miriam	
ITA	F	Stangherlin Sofia	
MEX	F	NORMAN PORTILLA KATHERINNE MARYCIELO	
MEX	F	PENA CARRILLO SARA CAMILA	
MEX	F	TERAN GOMEZ AMERICA NAOMI	
POR	F	Marques Rita	
POR	F	OLIVEIRA INÊS	
SVK	F	KADLECAJOVA Viktoria	
USA	F	Jocic Alexa	
USA	F	Kennaway Madelyn	
USA	F	McCammon Brielyn	
USA	F	Solis Bella Lan	
VEN	F	MARIA GABRIELA ANGULO	
VEN	F	OLIGINO DIANA VALENTINA	

Junior Kata Female

Karate1 Youth League - Cancun 2024, Iberostar Playa Paraíso Convention Center, Avenida del Sol Km 309, Playa Paraiso, 77710 Riviera Maya, MEX

2024-08-09

Tatami

3 09:00

Pool

1/2

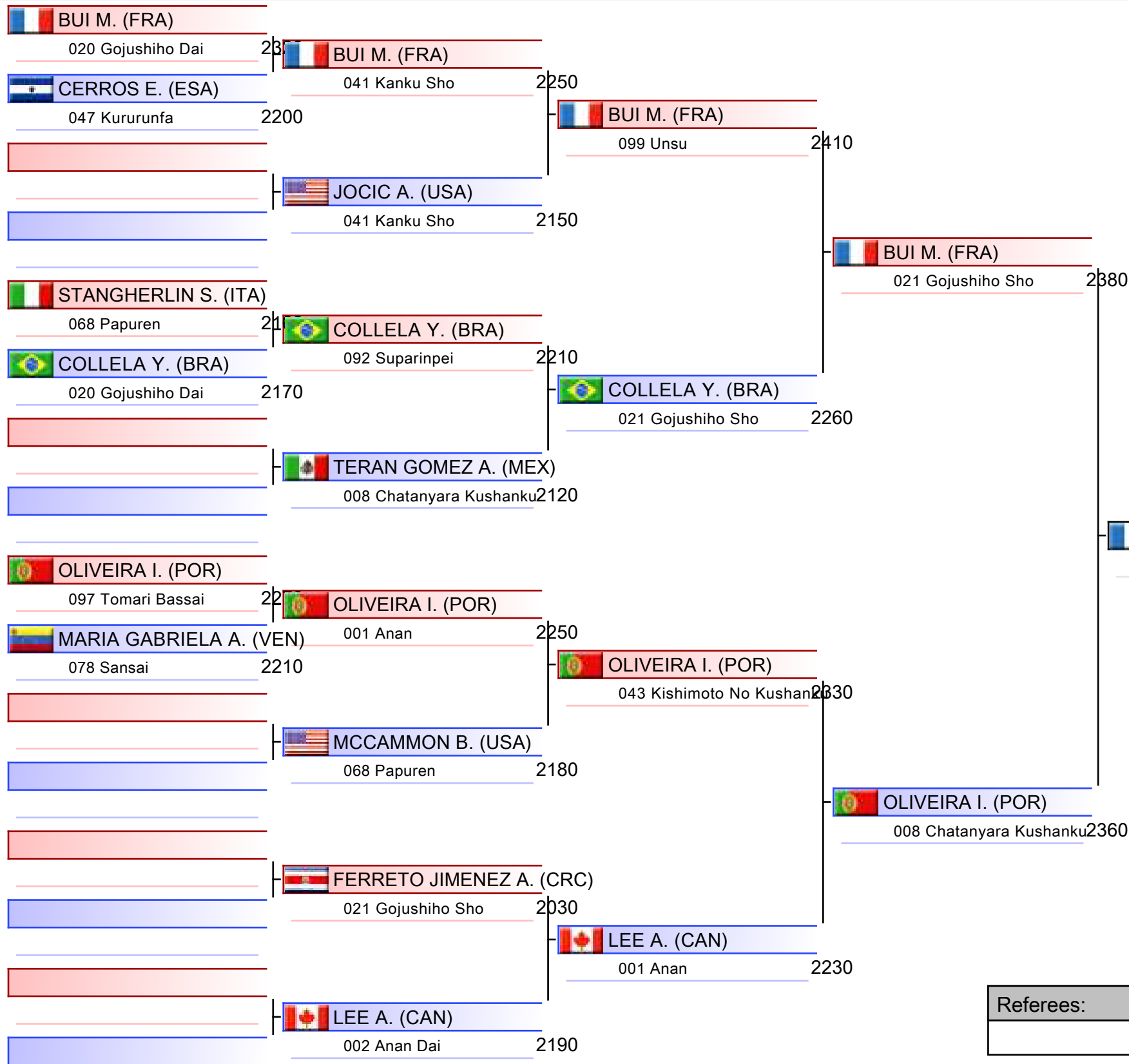

- | |
|---|
| 1. BUI MAÏ-LINH (FRA) |
| 2. MARQUES RITA (POR) |
| 3. OLIVEIRA INÊS (POR) |
| 3. OLIGINO DIANA VALENTINA (VEN) |
| 5. CERROS ELENA ISABEL (ESA) |
| 5. CARDONA GRAJALES SARA (COL) |
| 7. COLLELA YASMIN (BRA) |
| 7. NORMAN PORTILLA KATHERINNE MARYCIELO |

Referees:			

Junior Kata Female

Karate1 Youth League - Cancun 2024, Iberostar Playa Paraíso Convention Center, Avenida del Sol Km 309, Playa Paraiso, 77710 Riviera Maya, MEX

2024-08-09

Tatami
4 09:00

Pool
2/2

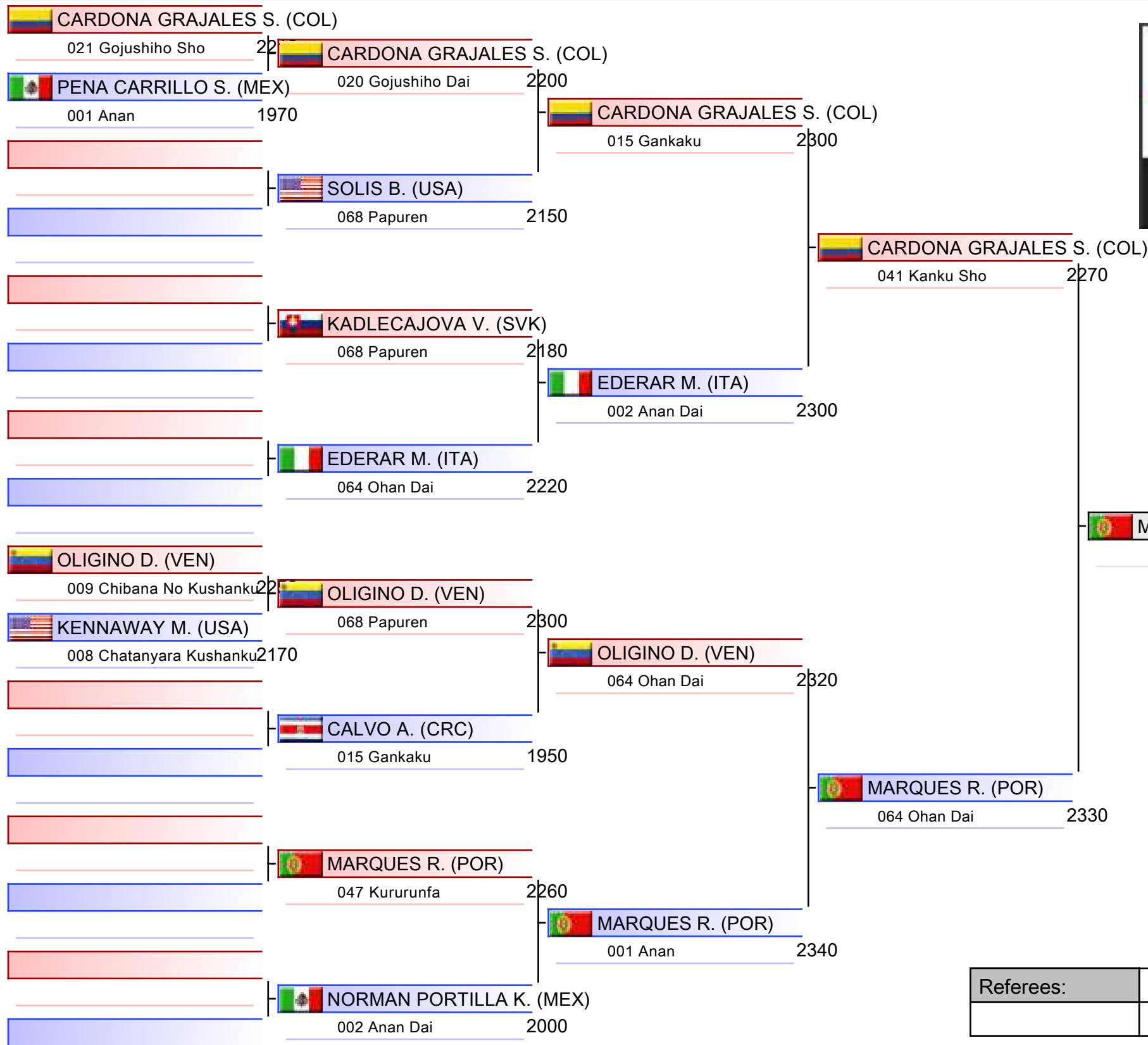

- | |
|---|
| 1. BUI MAÏ-LINH (FRA) |
| 2. MARQUES RITA (POR) |
| 3. OLIVEIRA INÊS (POR) |
| 3. OLIGINO DIANA VALENTINA (VEN) |
| 5. CERROS ELENA ISABEL (ESA) |
| 5. CARDONA GRAJALES SARA (COL) |
| 7. COLLELA YASMIN (BRA) |
| 7. NORMAN PORTILLA KATHERINNE MARYCIELO |

Referees:			

Pool winner-Junior Kata Female

Karate1 Youth League - Cancun 2024, Iberostar Playa Paraíso Convention Center, Avenida del Sol Km 309, Playa Paraiso, 77710 Riviera Maya, MEX

Tatami

Pool
1/1

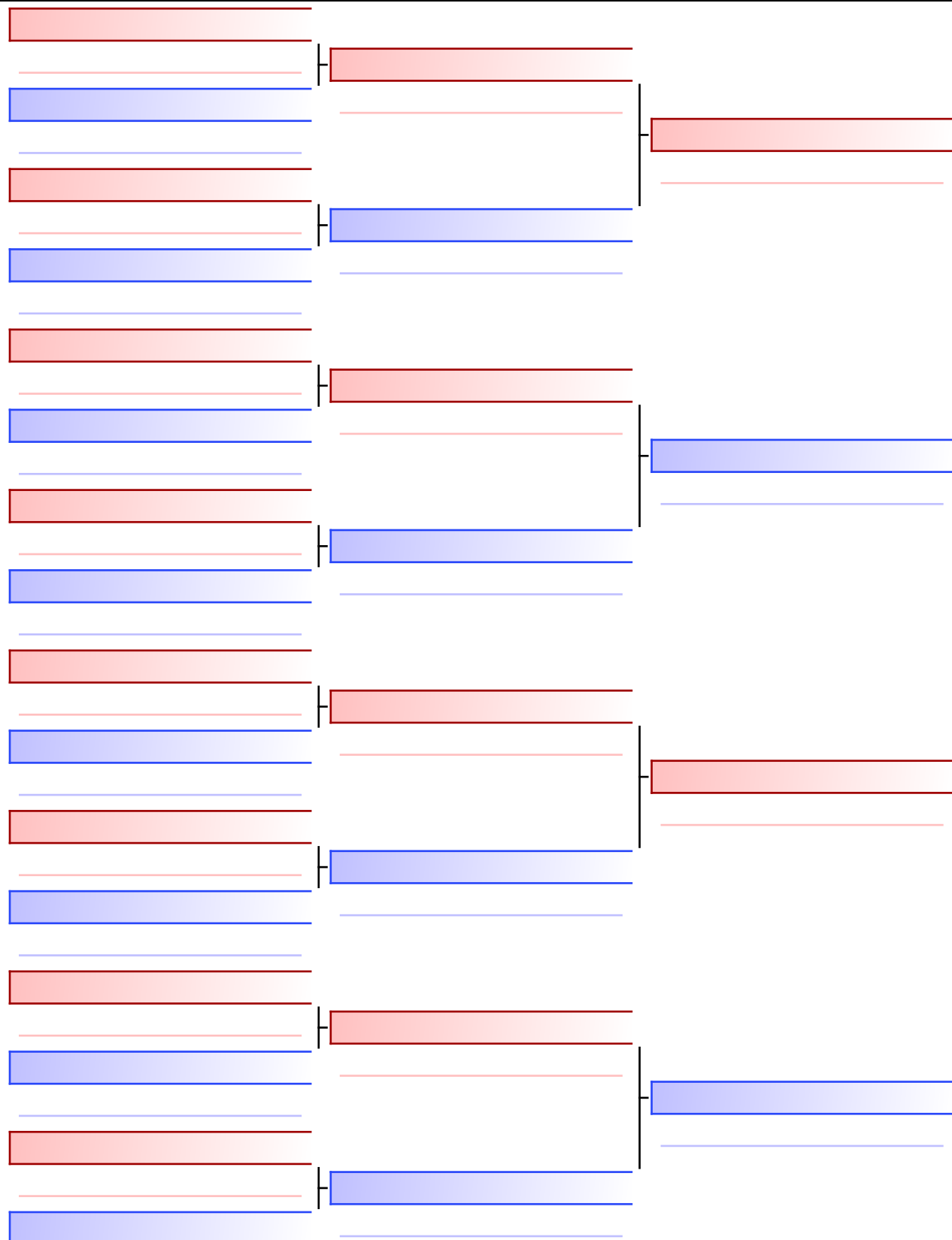

Final

 **BUI M. (FRA)**
092 Suparinpei 2410

#1 / 09.08

 **BUI M. (FRA)**

 **MARQUES R. (POR)**
092 Suparinpei 2300

1. BUI MAÏ-LINH (FRA)
2. MARQUES RITA (POR)
3. OLIVEIRA INÊS (POR)
3. OLIGINO DIANA VALENTINA (VEN)
5. CERROS ELENA ISABEL (ESA)
5. CARDONA GRAJALES SARA (COL)
7. COLLELA YASMIN (BRA)
7. NORMAN PORTILLA KATHERINNE MARYCIELO

Referees:			

Junior Kata Female

Karate1 Youth League - Cancun 2024

2024-08-09

Tatami
3 10:20

Pool
1

(c)sportdata GmbH & Co KG 2000-2024 (2024-08-11 14:41) v 10.2.0 build 1 (2024-08-09 20:34 CET) License: Online_Event_ID-875_Karate1YouthLeagueCancun2024 (expire 2024-08-25)

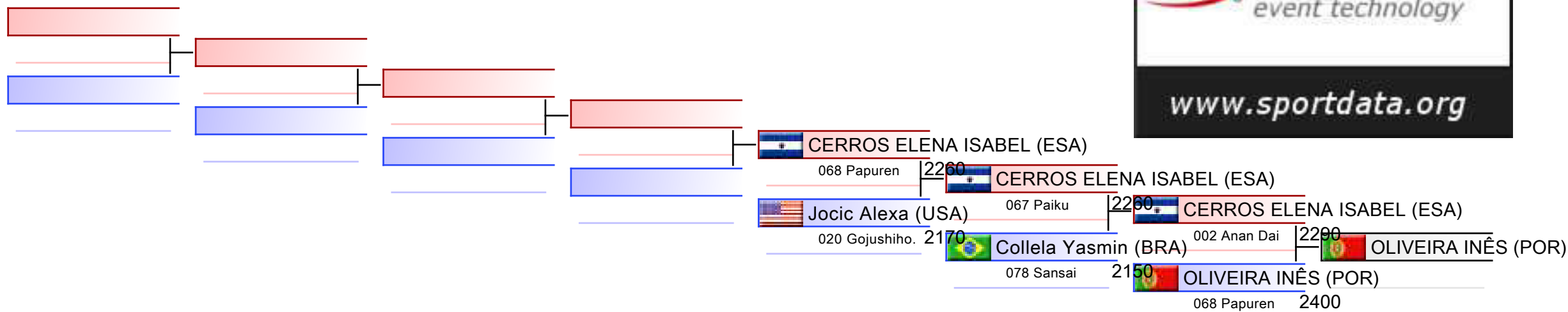

REPECHAGE: (1)

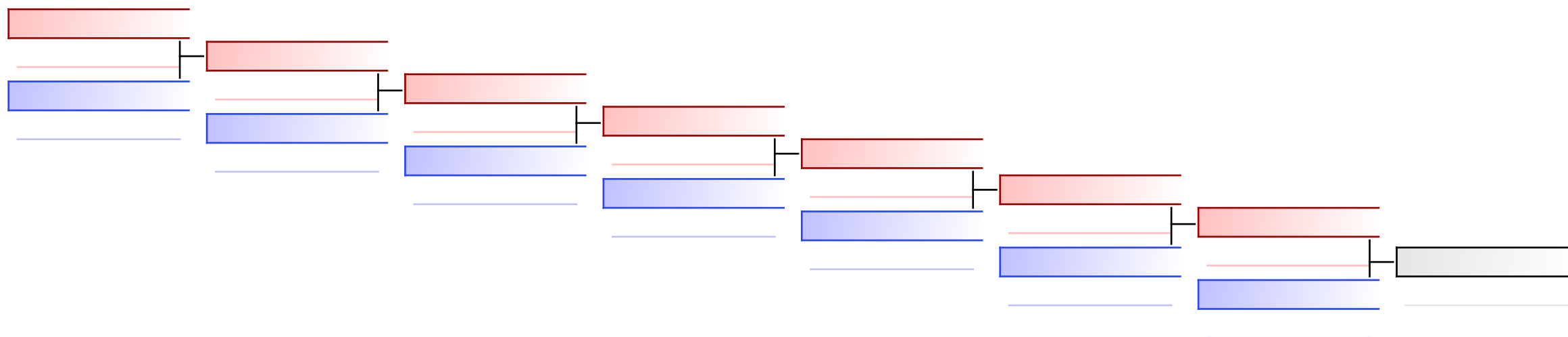

Referees:							
-----------	--	--	--	--	--	--	--

Junior Kata Female

Karate1 Youth League - Cancun 2024

2024-08-09

Tatami
4 10:15

Pool
2

(c)sportdata GmbH & Co KG 2000-2024 (2024-08-11 14:41) v 10.2.0 build 1 (2024-08-09 20:34 CET) License: Online_Event_ID-875_Karate1YouthLeagueCancun2024 (expire 2024-08-25)

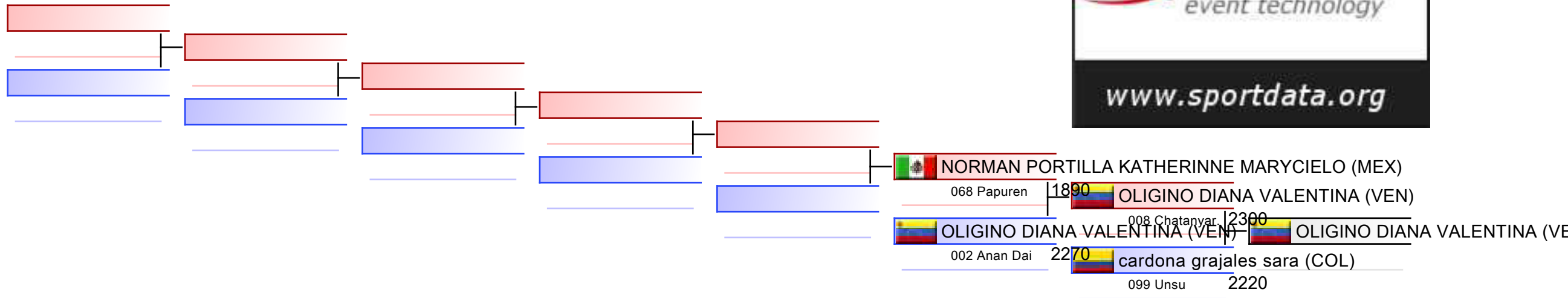

REPECHAGE: (2)

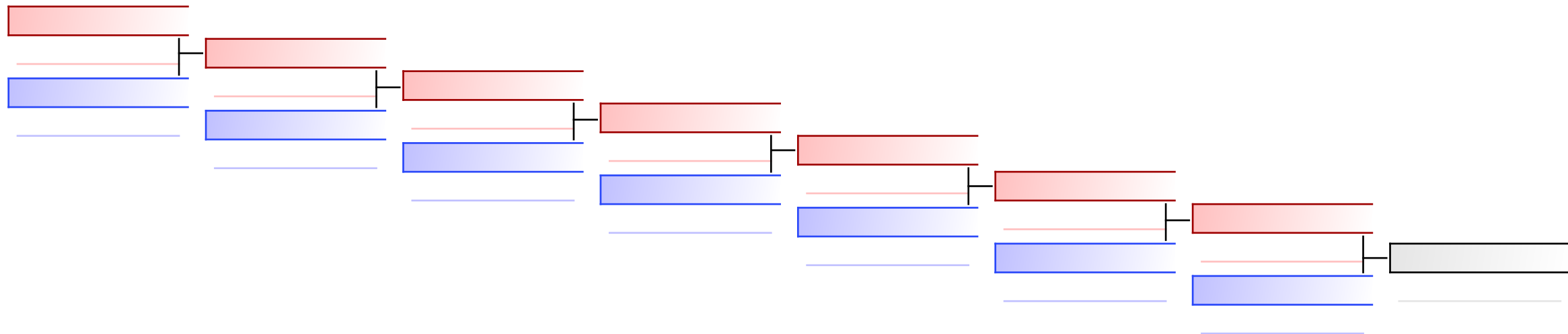

Referees:							
-----------	--	--	--	--	--	--	--



Karate1 Youth League - Cancun 2024 - 2024-08-08



Official Results

Junior Kata Female			
1	BUI MAI-LINH		FRA - FRANCE
2	MARQUES RITA		POR - PORTUGAL
3	OLIVEIRA INÊS		POR - PORTUGAL
3	OLIGINO DIANA VALENTINA		VEN - VENEZUELA
5	CERROS ELENA ISABEL		ESA - EL SALVADOR
5	CARDONA GRAJALES SARA		COL - COLOMBIA
7	COLLELA YASMIN		BRA - BRAZIL
7	NORMAN PORTILLA KATHERINNE MARYCIELO		MEX - MEXICO
9	JOCIC ALEXA		USA - UNITED STATES

JUNIOR KATA MALE



Karate1 Youth League - Cancun 2024
ENTRIES BY WEIGHT CATEGORY



Junior Kata Male
As of 11 AUG 2024

NOC Code	Gender	Name	Seeding
AUT	M	WU TIMON	
CAN	M	GRUITIA MATTHEW	
CRC	M	ABELLAN ORLANDO	
CRC	M	MURILLO JOSEPH	
CRC	M	RODRIGUEZ DANIEL	
CRC	M	RODRIGUEZ SEBASTIAN	
DOM	M	BERA BISONO YUSEF	
ECU	M	NARVAEZ MARCO	
IRI	M	Nadimighasroldasht Alireza	
ITA	M	Camanzo Salvatore	
ITA	M	CAPONERA Emanuele	
ITA	M	Di Rubba Luigi	
ITA	M	ederar karim	
ITA	M	Ollagnero Giovanni	
MEX	M	DELGADO SANCHEZ ALFONSO ANDRE	
MEX	M	GARCIA VALADEZ JUAN PABLO	
MEX	M	GARZA VIZCAINO JOSE MARCELO	
MEX	M	LOPEZ MUNOZ ANGEL IVAN	
MEX	M	MACIAS CASTELLANOS JUAN PABLO	
MEX	M	OROZCO GALICIA DANTE ALEJANDRO	
MEX	M	SANTIAGO ZAVALA LUIS EDUARDO	
MEX	M	ZAVALA MERCADO JOSE JUAN	
POR	M	Oliveira Martim	
SUI	M	Schedel Nolan	
USA	M	Nacu Mateo	
USA	M	Ricotti Luca	
USA	M	Santos Lance	
USA	M	Seitz Brayden	
USA	M	Twaddell Xander	

Junior Kata Male

Karate1 Youth League - Cancun 2024, Iberostar Playa Paraíso Convention Center, Avenida del Sol Km 309, Playa Paraiso, 77710 Riviera Maya, MEX

2024-08-09

Tatami

1 09:00

Pool

1/2

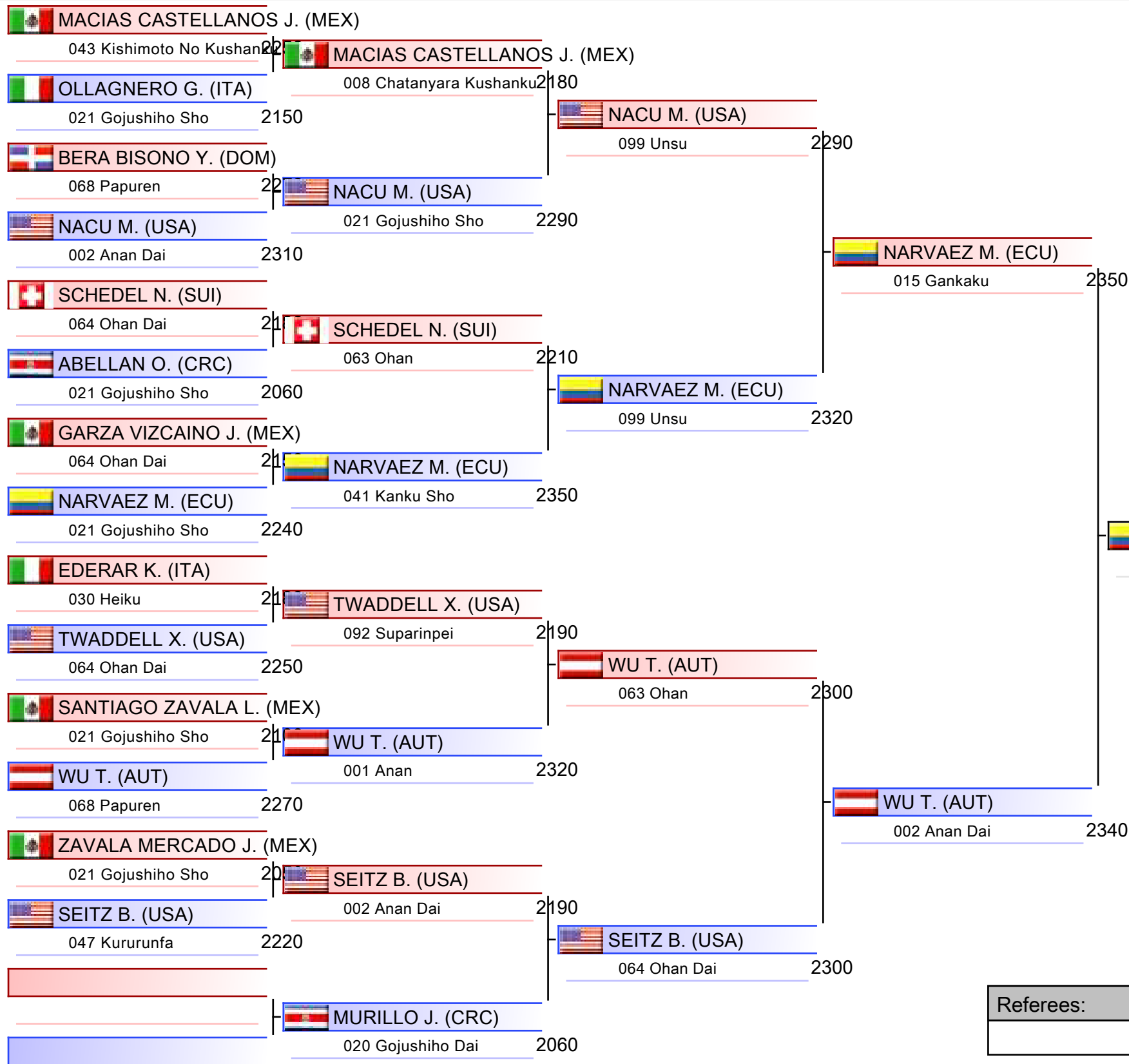

1. DI RUBBA LUIGI (ITA)
2. NARVAEZ MARCO (ECU)
3. CAPONERA EMANUELE (ITA)
3. WU TIMON (AUT)
5. SANTOS LANCE (USA)
5. NACU MATEO (USA)
7. GARCIA VALADEZ JUAN PABLO (MEX)
7. SCHEDEL NOLAN (SUI)

Referees:			

Junior Kata Male

Karate1 Youth League - Cancun 2024, Iberostar Playa Paraíso Convention Center, Avenida del Sol Km 309, Playa Paraiso, 77710 Riviera Maya, MEX

2024-08-09

Tatami

2 09:00

Pool

2/2

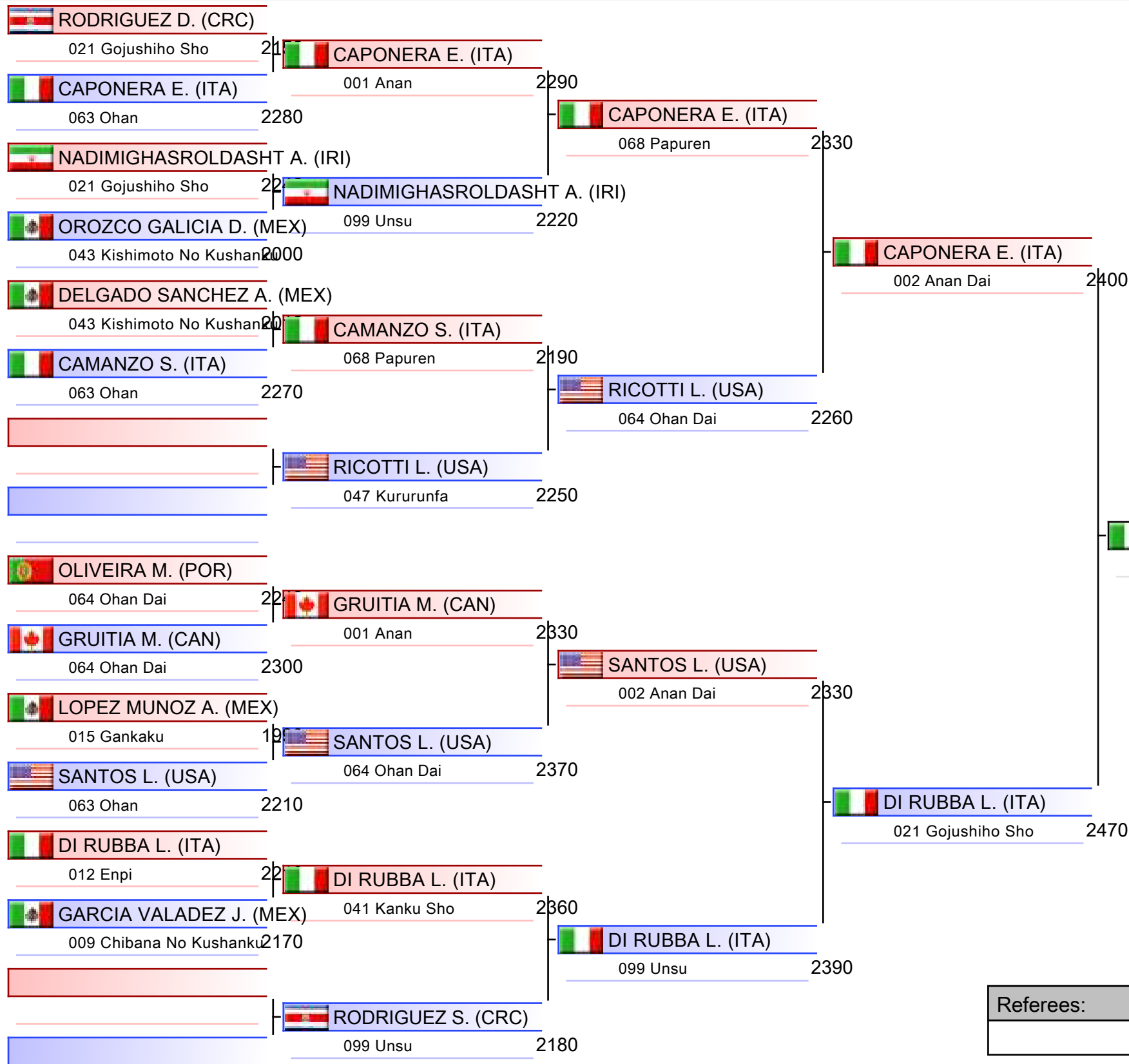

- | |
|------------------------------------|
| 1. DI RUBBA LUIGI (ITA) |
| 2. NARVAEZ MARCO (ECU) |
| 3. CAPONERA EMANUELE (ITA) |
| 3. WU TIMON (AUT) |
| 5. SANTOS LANCE (USA) |
| 5. NACU MATEO (USA) |
| 7. GARCIA VALADEZ JUAN PABLO (MEX) |
| 7. SCHEDEL NOLAN (SUI) |

Referees:			

Pool winner-Junior Kata Male

Karate1 Youth League - Cancun 2024, Iberostar Playa Paraíso Convention Center, Avenida del Sol Km 309, Playa Paraiso, 77710 Riviera Maya, MEX

Tatami

Pool

1/1

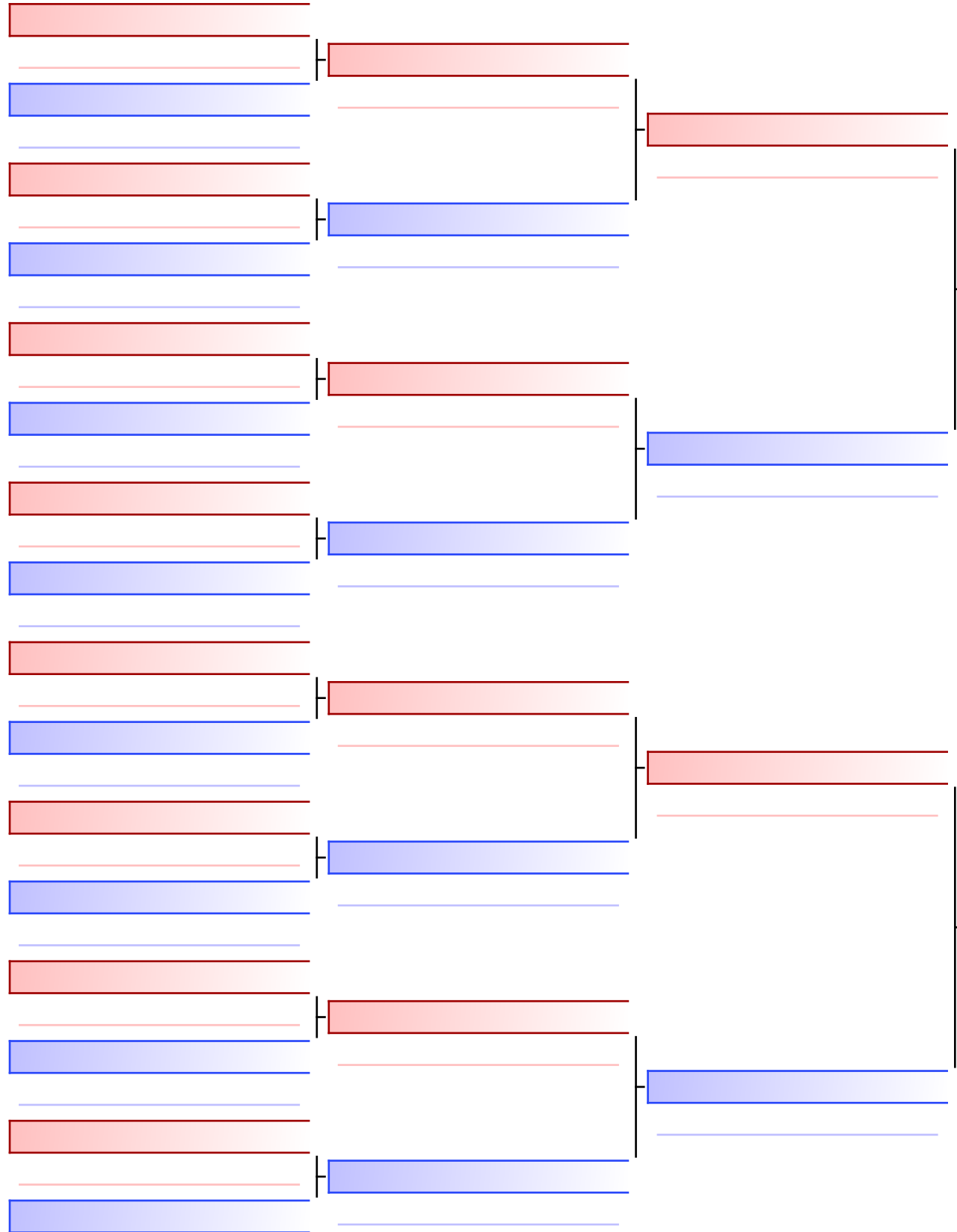

Final

 **NARVAEZ M. (ECU)**
099 Unsu 2430

#2 / 09.08

 **DI RUBBA L. (ITA)**

 **DI RUBBA L. (ITA)**
020 Gojushiho Dai 2460

- | |
|------------------------------------|
| 1. DI RUBBA LUIGI (ITA) |
| 2. NARVAEZ MARCO (ECU) |
| 3. CAPONERA EMANUELE (ITA) |
| 3. WU TIMON (AUT) |
| 5. SANTOS LANCE (USA) |
| 5. NACU MATEO (USA) |
| 7. GARCIA VALADEZ JUAN PABLO (MEX) |
| 7. SCHEDEL NOLAN (SUI) |

Referees:			

Junior Kata Male

Karate1 Youth League - Cancun 2024

2024-08-09

Tatami
1 10:55

Pool
1

(c)sportdata GmbH & Co KG 2000-2024 (2024-08-11 14:41) v 10.2.0 build 1 (2024-08-09 20:34 CET) License: Online_Event_ID-875_Karate1YouthLeagueCancun2024 (expire 2024-08-25)

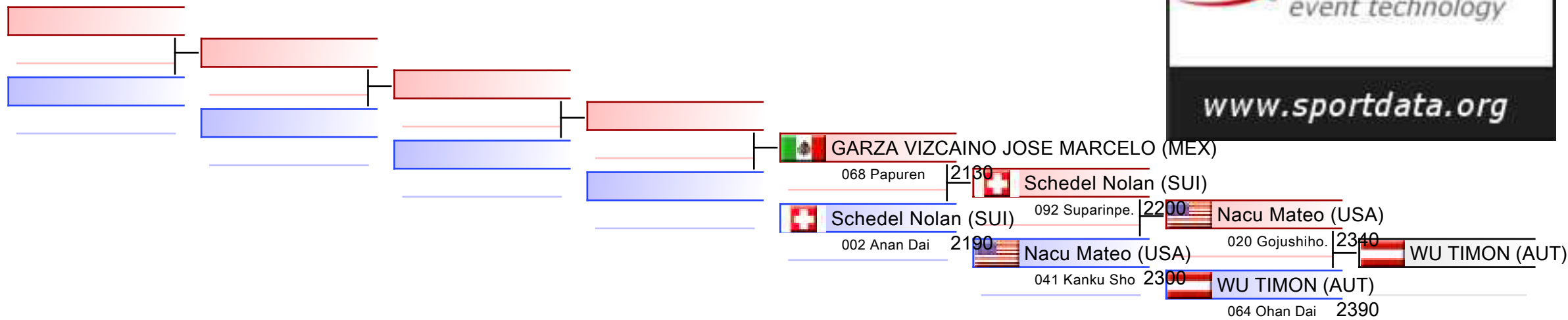

REPECHAGE: (1)

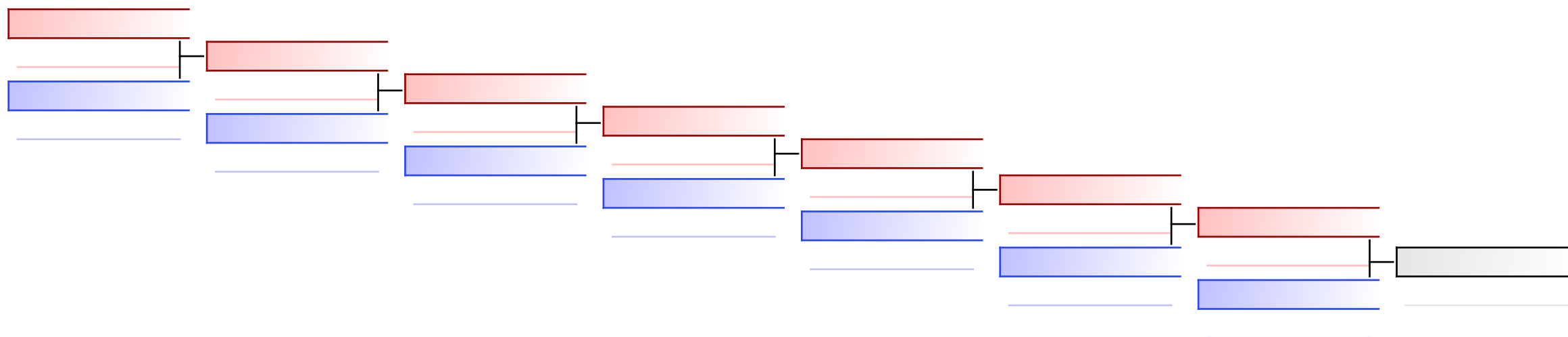

Referees:							
-----------	--	--	--	--	--	--	--

Junior Kata Male

Karate1 Youth League - Cancun 2024

2024-08-09

Tatami
2 10:45

Pool
2

(c)sportdata GmbH & Co KG 2000-2024 (2024-08-11 14:41) v 10.2.0 build 1 (2024-08-09 20:34 CET) License: Online_Event_ID-875_Karate1YouthLeagueCancun2024 (expire 2024-08-25)

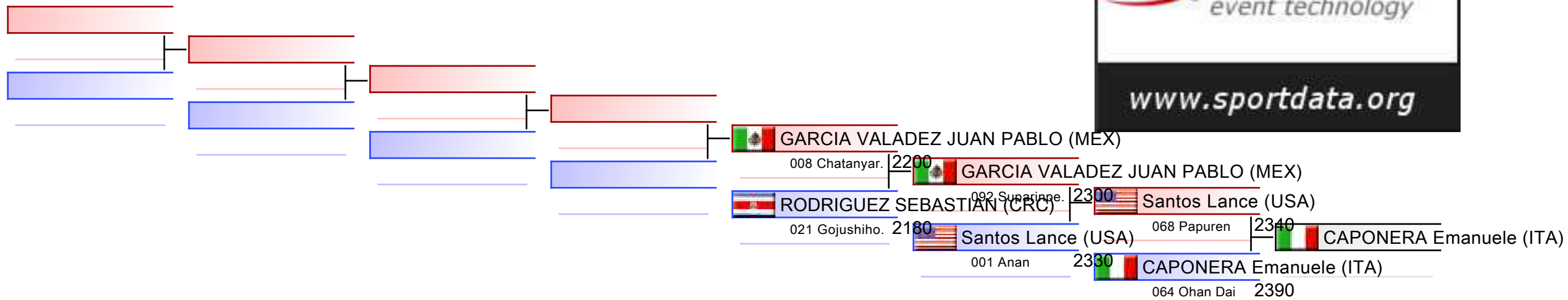

REPECHAGE: (2)

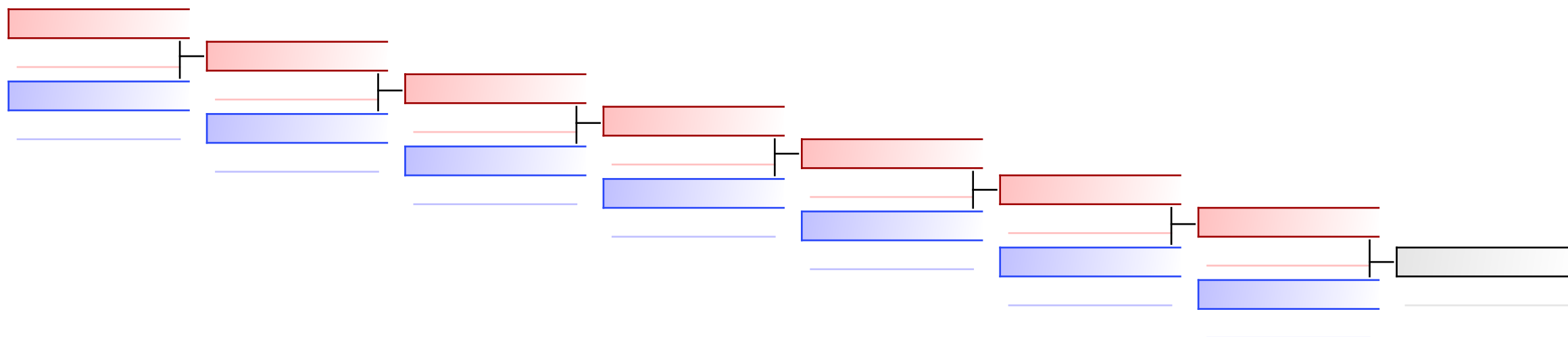

Referees:							
-----------	--	--	--	--	--	--	--



Karate1 Youth League - Cancun 2024 - 2024-08-08



Official Results

Junior Kata Male			
1	DI RUBBA LUIGI		ITA - ITALY
2	NARVAEZ MARCO		ECU - ECUADOR
3	CAPONERA EMANUELE		ITA - ITALY
3	WU TIMON		AUT - AUSTRIA
5	SANTOS LANCE		USA - UNITED STATES
5	NACU MATEO		USA - UNITED STATES
7	GARCIA VALADEZ JUAN PABLO		MEX - MEXICO
7	SCHEDDEL NOLAN		SUI - SWITZERLAND
9	RODRIGUEZ SEBASTIAN		CRC - COSTA RICA
9	GARZA VIZCAINO JOSE MARCELO		MEX - MEXICO

JUNIOR KUMITE FEMALE -48 KG



Karate1 Youth League - Cancun 2024
ENTRIES BY WEIGHT CATEGORY



Junior Kumite Female -48 kg
As of 11 AUG 2024

NOC Code	Gender	Name	Seeding
COL	F	Lopez Bernal Maria Del Mar	
COL	F	VALDERRAMA GARCIA VALERIA	
CRO	F	TRSTENJAK AIDA	
DEN	F	Bath Sofia	
GER	F	Drehmann Emily-Chiara	
GUA	F	FLORES ORTIZ MARIA RENEE	
ITA	F	GENTA MICOL	
MEX	F	CABRERA PALOMINO GLORIA YESENIA	
SVK	F	Jalowiczorova Veronika	
SWE	F	Nyman Agnes	
USA	F	Jocic Alexa	
VEN	F	MARIA GABRIELA ANGULO	

Junior Kumite Female -48 kg

Karate1 Youth League - Cancun 2024, Iberostar Playa Paraíso Convention Center, Avenida del Sol Km 309, Playa Paraiso, 77710 Riviera Maya, MEX

2024-08-09

Tatami
1 11:25

Pool
1/1

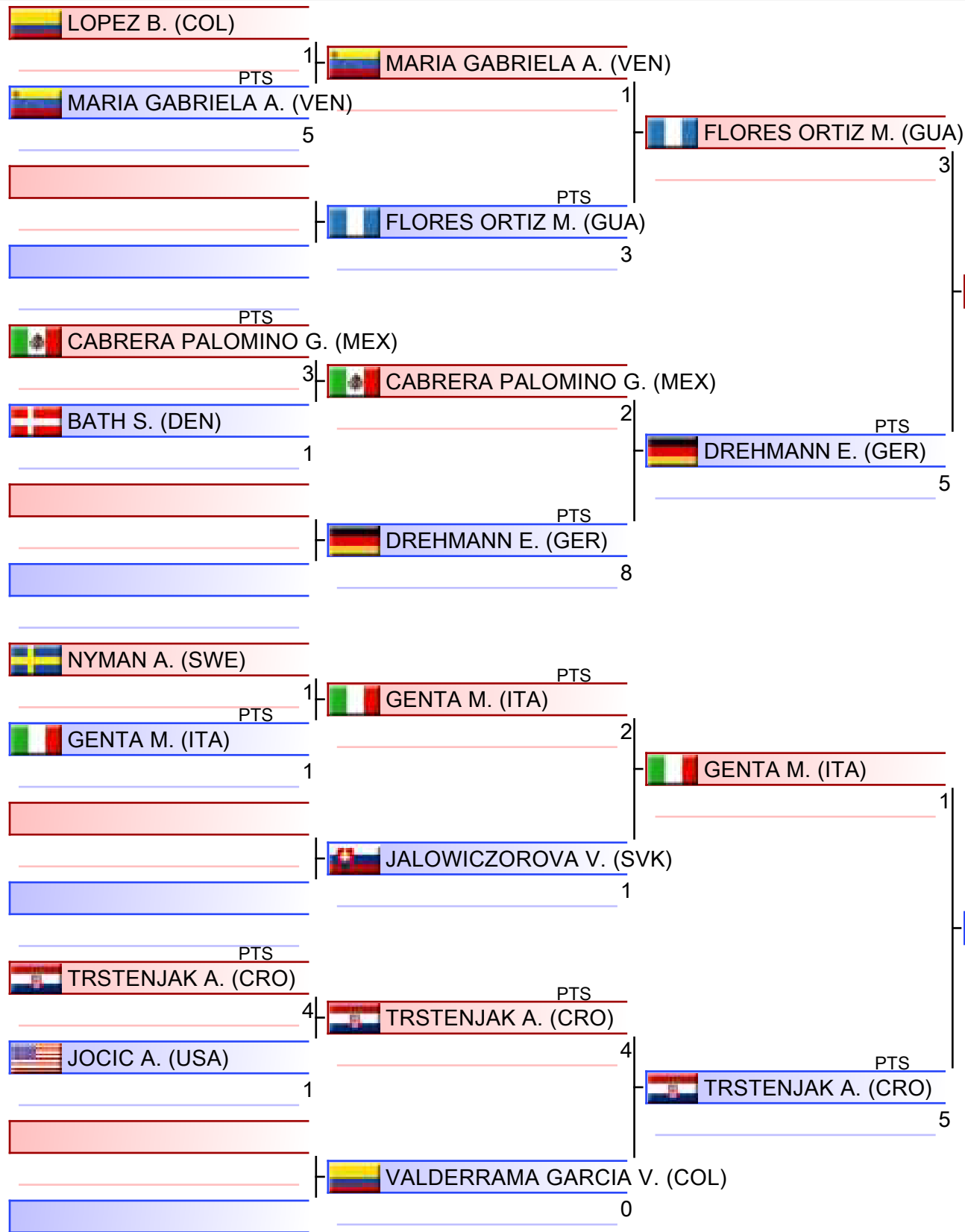

1. TRSTENJAK AIDA (CRO)
2. DREHMANN EMILY-CHIARA (GER)
3. VALDERRAMA GARCIA VALERIA (COL)
3. FLORES ORTIZ MARIA RENEE (GUA)
5. GENTA MICOL (ITA)
5. CABRERA PALOMINO GLORIA YESENIA (MEX)
7. JOCIC ALEXA (USA)

Referees:			

Junior Kumite Female -48 kg

Karate1 Youth League - Cancun 2024

2024-08-09

Tatami
1 12:15

Pool
1

(c)sportdata GmbH & Co KG 2000-2024 (2024-08-11 14:41) v 10.2.0 build 1 (2024-08-09 20:34 CET) License: Online_Event_ID-875_Karate1YouthLeagueCancun2024 (expire 2024-08-25)

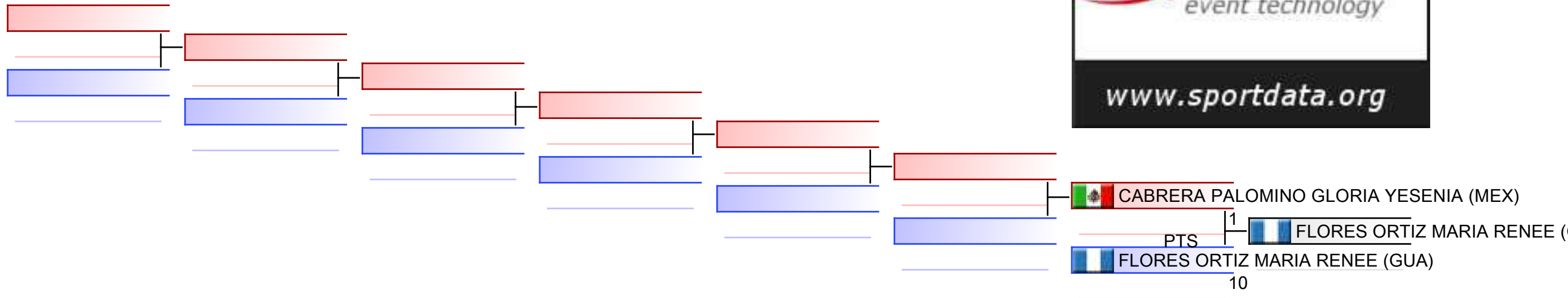

REPECHAGE: (1)

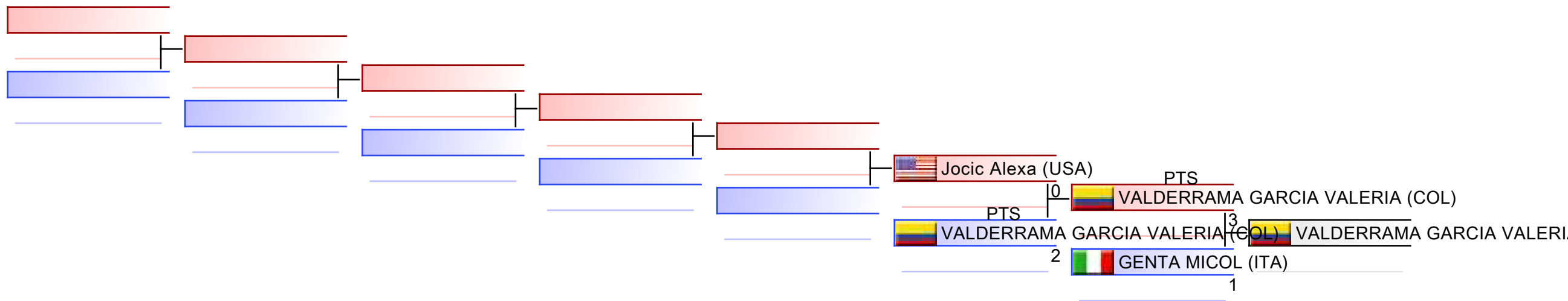

Referees:							
-----------	--	--	--	--	--	--	--



Karate1 Youth League - Cancun 2024 - 2024-08-08



Official Results

Junior Kumite Female -48 kg			
1	TRSTENJAK AIDA		CRO - CROATIA
2	DREHMANN EMILY-CHIARA		GER - GERMANY
3	VALDERRAMA GARCIA VALERIA		COL - COLOMBIA
3	FLORES ORTIZ MARIA RENEE		GUA - GUATEMALA
5	GENTA MICOL		ITA - ITALY
5	CABRERA PALOMINO GLORIA YESENIA		MEX - MEXICO
7	JOCIC ALEXA		USA - UNITED STATES

JUNIOR KUMITE FEMALE -53 KG



Karate1 Youth League - Cancun 2024
ENTRIES BY WEIGHT CATEGORY



Junior Kumite Female -53 kg
As of 11 AUG 2024

NOC Code	Gender	Name	Seeding
CAN	F	Delarosa Kiara	
CHI	F	MELIAN PEREZ ANTONIA	
COL	F	SANCHEZ QUICENO JULIETA	
CRC	F	FERRETO JIMENEZ ANGHELINA	
CRC	F	JIMENEZ MARIA	
ESP	F	VIZCAINO CALVO RUTH	
MEX	F	CONTRERAS MUNOZ ANA KARENI	
MEX	F	NORMAN PORTILLA KATHERINNE MARYCIELO	
MEX	F	REYNA CANO AYLIN YAMILET	
PAR	F	MENCIA JAZMIN	
POL	F	CHLEBOWSKA ANNA	
POL	F	Dopieralska Zuzanna	
USA	F	McCammon Brielyn	
VEN	F	REBECA CAMPOS	

Junior Kumite Female -53 kg

Karate1 Youth League - Cancun 2024, Iberostar Playa Paraíso Convention Center, Avenida del Sol Km 309, Playa Paraiso, 77710 Riviera Maya, MEX

2024-08-09

Tatami
2 11:25

Pool
1/1

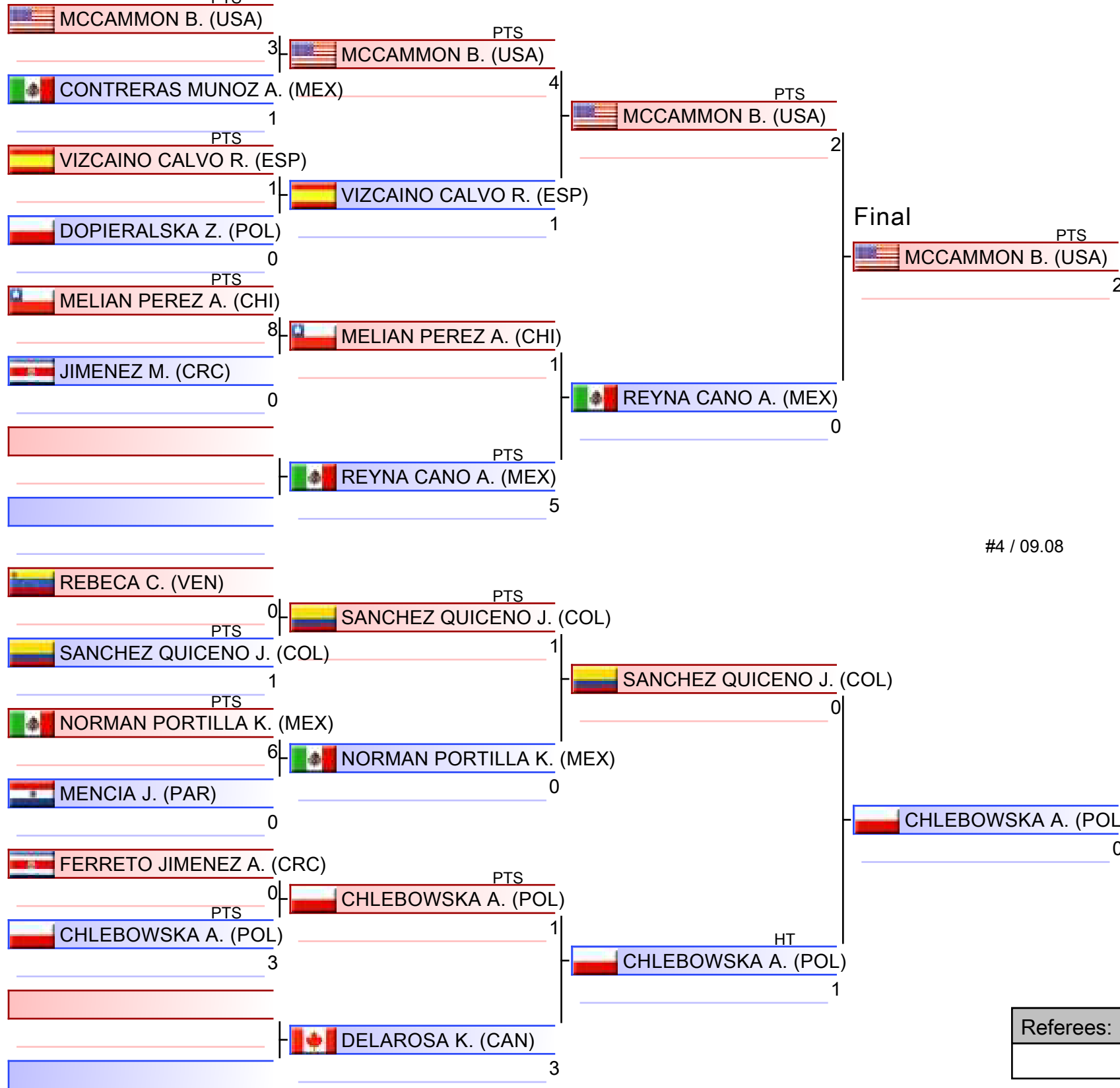

- | |
|-------------------------------------|
| 1. MCCAMMON BRIELYN (USA) |
| 2. CHLEBOWSKA ANNA (POL) |
| 3. VIZCAINO CALVO RUTH (ESP) |
| 3. SANCHEZ QUICENO JULIETA (COL) |
| 5. REYNA CANO AYLIN YAMILET (MEX) |
| 5. FERRETO JIMENEZ ANGHELINA (CRC) |
| 7. CONTRERAS MUNOZ ANA KARENI (MEX) |
| 7. DELAROSA KIARA (CAN) |

Referees:			

Junior Kumite Female -53 kg

Karate1 Youth League - Cancun 2024

2024-08-09

Tatami
2 12:25

Pool
1

(c)sportdata GmbH & Co KG 2000-2024 (2024-08-11 14:41) v 10.2.0 build 1 (2024-08-09 20:34 CET) License: Online_Event_ID-875_Karate1YouthLeagueCancun2024 (expire 2024-08-25)

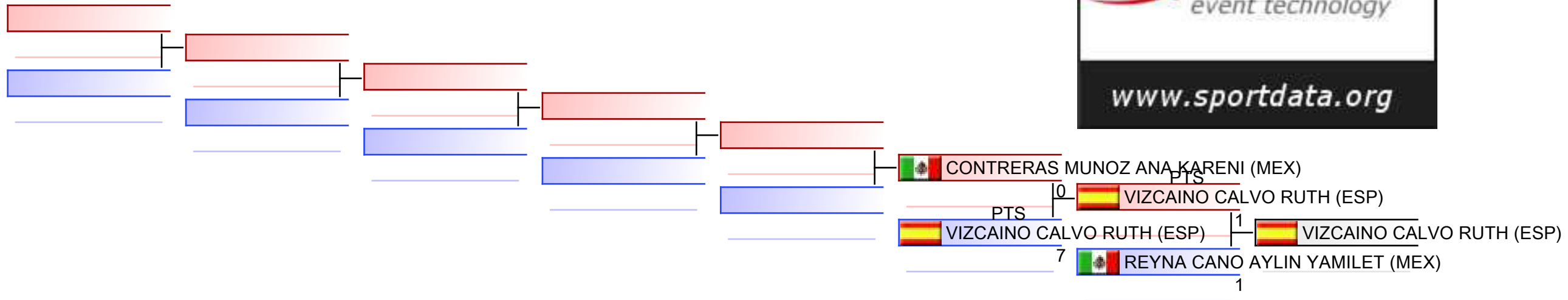

REPECHAGE: (1)

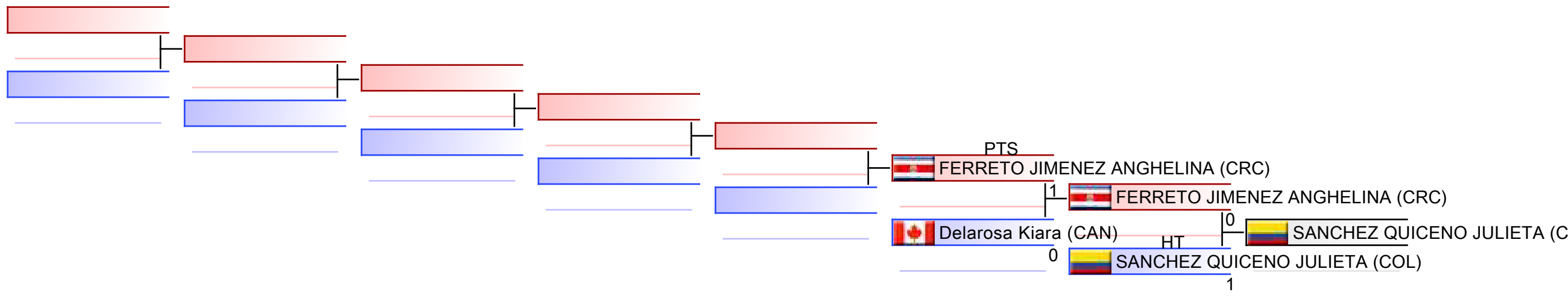

Referees:							
-----------	--	--	--	--	--	--	--



Karate1 Youth League - Cancun 2024 - 2024-08-08



Official Results

Junior Kumite Female -53 kg			
1	MCCAMMON BRIELYN		USA - UNITED STATES
2	CHLEBOWSKA ANNA		POL - POLAND
3	VIZCAINO CALVO RUTH		ESP - SPAIN
3	SANCHEZ QUICENO JULIETA		COL - COLOMBIA
5	REYNA CANO AYLIN YAMILET		MEX - MEXICO
5	FERRETO JIMENEZ ANGHELINA		CRC - COSTA RICA
7	CONTRERAS MUNOZ ANA KARENI		MEX - MEXICO
7	DELAROSA KIARA		CAN - CANADA

JUNIOR KUMITE FEMALE -59 KG



Karate1 Youth League - Cancun 2024
ENTRIES BY WEIGHT CATEGORY



Junior Kumite Female -59 kg
As of 11 AUG 2024

NOC Code	Gender	Name	Seeding
AUT	F	CETIN CEYLIN	
CAN	F	JAWKAR ANUSHKA	
CAN	F	Lee Amanda	
CAN	F	Nijjar Anisha	
CHI	F	CAVICCHIOLI TOLEDO CAMILA	
COL	F	cardona grajales sara	
CRC	F	CALVO ARIELA	
GER	F	Hellen Ili	
GER	F	Mussweiler Mia	
MEX	F	RAMOS ALONSO RENATA	

Junior Kumite Female -59 kg

Karate1 Youth League - Cancun 2024, Iberostar Playa Paraíso Convention Center, Avenida del Sol Km 309, Playa Paraiso, 77710 Riviera Maya, MEX

2024-08-09

Tatami
4 12:00

Pool
1/1

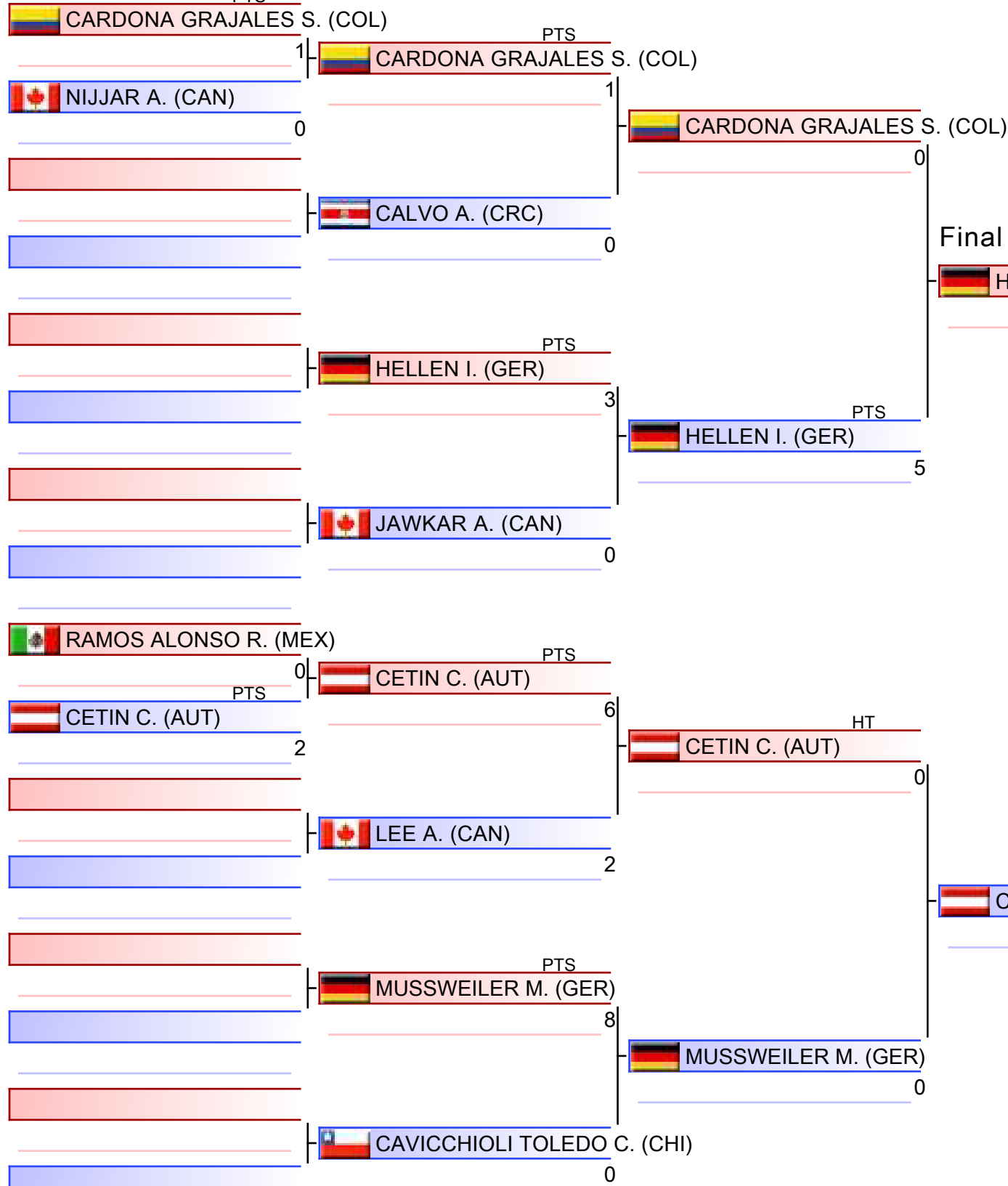

1. HELLEN ILI (GER)
2. CETIN CEYLIN (AUT)
3. CARDONA GRAJALES SARA (COL)
3. MUSSWEILER MIA (GER)
5. JAWKAR ANUSHKA (CAN)
5. LEE AMANDA (CAN)
7. RAMOS ALONSO RENATA (MEX)

Referees:			

Junior Kumite Female -59 kg

Karate1 Youth League - Cancun 2024

2024-08-09

Tatami
4 12:40

Pool
1

(c)sportdata GmbH & Co KG 2000-2024 (2024-08-11 14:41) v 10.2.0 build 1 (2024-08-09 20:34 CET) License: Online_Event_ID-875_Karate1YouthLeagueCancun2024 (expire 2024-08-25)

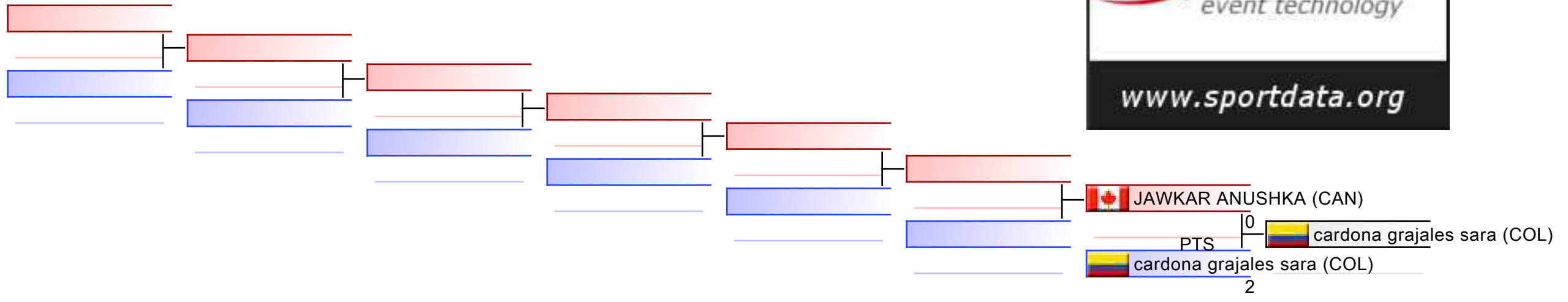

REPECHAGE: (1)

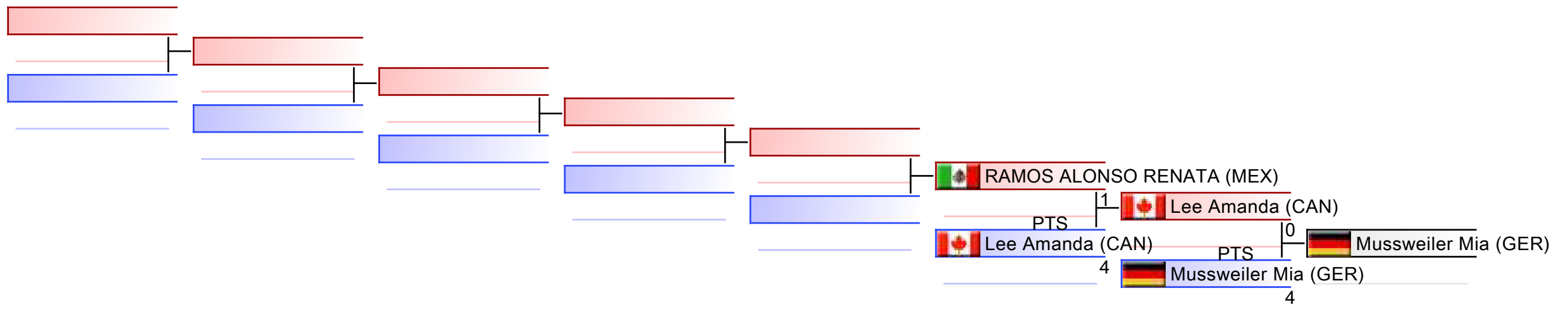

Referees:							
-----------	--	--	--	--	--	--	--



Karate1 Youth League - Cancun 2024 - 2024-08-08



Official Results

Junior Kumite Female -59 kg			
1	HELLEN ILI		GER - GERMANY
2	CETIN CEYLIN		AUT - AUSTRIA
3	CARDONA GRAJALES SARA		COL - COLOMBIA
3	MUSSWEILER MIA		GER - GERMANY
5	JAWKAR ANUSHKA		CAN - CANADA
5	LEE AMANDA		CAN - CANADA
7	RAMOS ALONSO RENATA		MEX - MEXICO

JUNIOR KUMITE FEMALE -66 KG



Karate1 Youth League - Cancun 2024
ENTRIES BY WEIGHT CATEGORY



Junior Kumite Female -66 kg
As of 11 AUG 2024

NOC Code	Gender	Name	Seeding
CHI	F	GARAY SUAZO ISIDORA NOEMI	
CHI	F	PERALTA MARCO DANDARU IGNACIA	
CRC	F	DIAZ SOFIA	
CRO	F	GRGUREVIC LEA	
CRO	F	STRAHIJA LAURA	
DEN	F	Bath Astamaja	
ESP	F	Mazariegos Iglesias Irene	
GUA	F	AGUILAR ALBIZURES MARIA RENEE	
MEX	F	BARROSO RIOS ASHLEY CAMILA	
MEX	F	QUINTERO FLORES GEOMARA	
NED	F	Valk Imane	
POR	F	Cadete Beatriz	
SVK	F	Zeumerova Alexandra	
USA	F	Lavarnway Sydney	

Junior Kumite Female -66 kg

Karate1 Youth League - Cancun 2024, Iberostar Playa Paraíso Convention Center, Avenida del Sol Km 309, Playa Paraiso, 77710 Riviera Maya, MEX

2024-08-09

Tatami
1 12:35

Pool
1/1

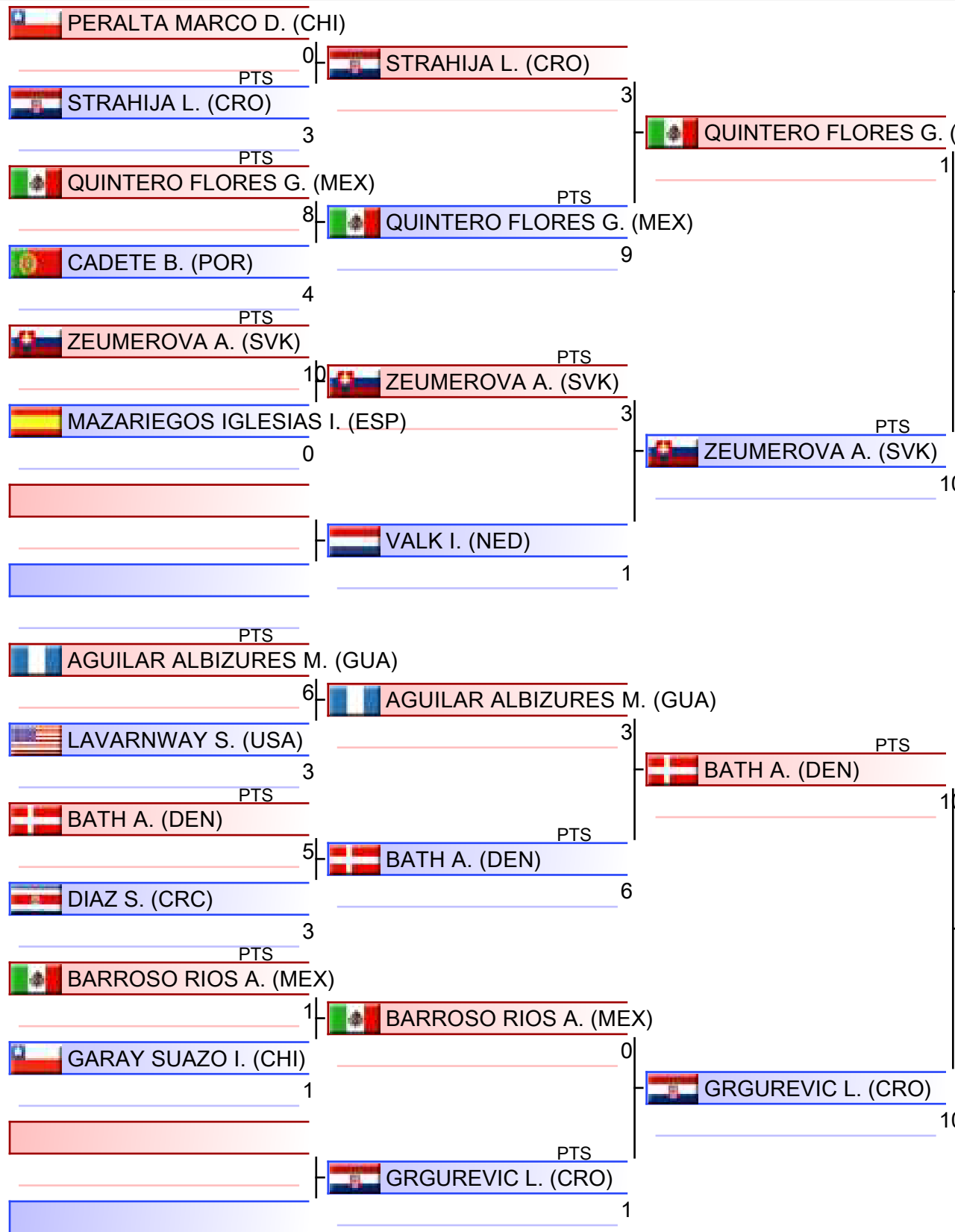

#6 / 09.08

- | |
|--|
| 1. ZEUMEROVA ALEXANDRA (SVK) |
| 2. BATH ASTAMAJA (DEN) |
| 3. VALK IMANE (NED) |
| 3. AGUILAR ALBIZURES MARIA RENEE (GUA) |
| 5. GRGUREVIC LEA (CRO) |
| 5. QUINTERO FLORES GEOMARA (MEX) |
| 7. DIAZ SOFIA (CRC) |
| 7. MAZARIEGOS IGLESIAS IRENE (ESP) |

Referees:			

Junior Kumite Female -66 kg

Karate1 Youth League - Cancun 2024

2024-08-09

Tatami
1 13:35

Pool
1

(c)sportdata GmbH & Co KG 2000-2024 (2024-08-11 14:41) v 10.2.0 build 1 (2024-08-09 20:34 CET) License: Online_Event_ID-875_Karate1YouthLeagueCancun2024 (expire 2024-08-25)

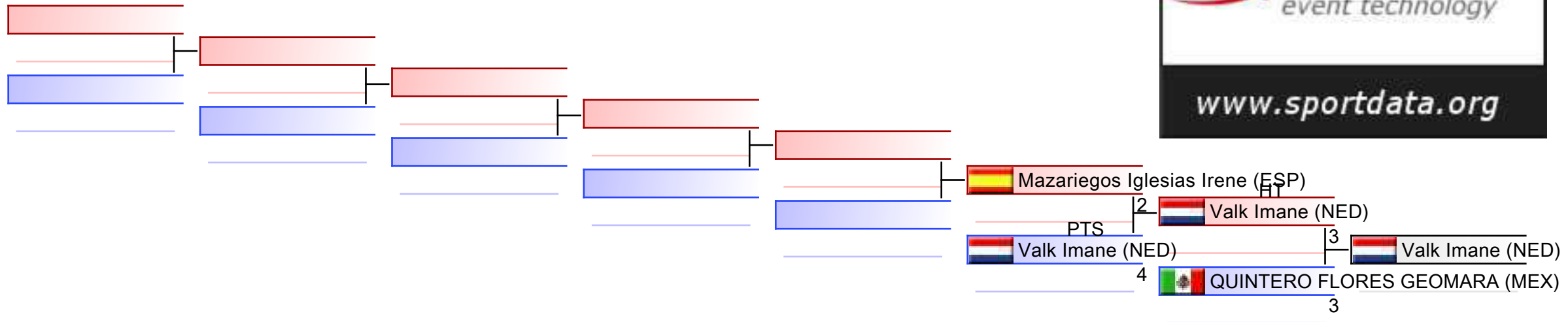

REPECHAGE: (1)

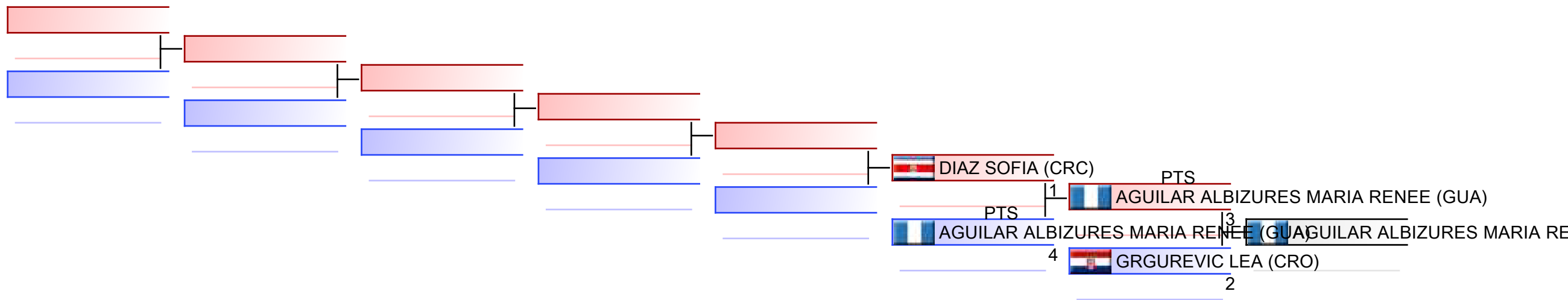

Referees:							
-----------	--	--	--	--	--	--	--



Karate1 Youth League - Cancun 2024 - 2024-08-08



Official Results

Junior Kumite Female -66 kg			
1	ZEUMEROVA ALEXANDRA		SVK - SLOVAKIA
2	BATH ASTAMAJA		DEN - DENMARK
3	VALK IMANE		NED - NETHERLANDS
3	AGUILAR ALBIZURES MARIA RENEE		GUA - GUATEMALA
5	GRGUREVIC LEA		CRO - CROATIA
5	QUINTERO FLORES GEOMARA		MEX - MEXICO
7	DIAZ SOFIA		CRC - COSTA RICA
7	MAZARIEGOS IGLESIAS IRENE		ESP - SPAIN

JUNIOR KUMITE FEMALE 66+ KG



Karate1 Youth League - Cancun 2024
ENTRIES BY WEIGHT CATEGORY



Junior Kumite Female 66+ kg
As of 11 AUG 2024

NOC Code	Gender	Name	Seeding
CAN	F	HOLLYBOW ANIKA	
CHI	F	Puga Rojas Fiorentina Ignacia	
CHI	F	SOTO SEPULVEDA MARTINA IGNACIA	
CRC	F	MORENO AMANDA	
ENG	F	Fry Autumn	
TUN	F	Ettaleb Meriame	

Junior Kumite Female 66+ kg

Karate1 Youth League - Cancun 2024, Iberostar Playa Paraíso Convention Center, Avenida del Sol Km 309, Playa Paraiso, 77710 Riviera Maya, MEX

2024-08-09

Tatami

3 12:20

Pool

1/1

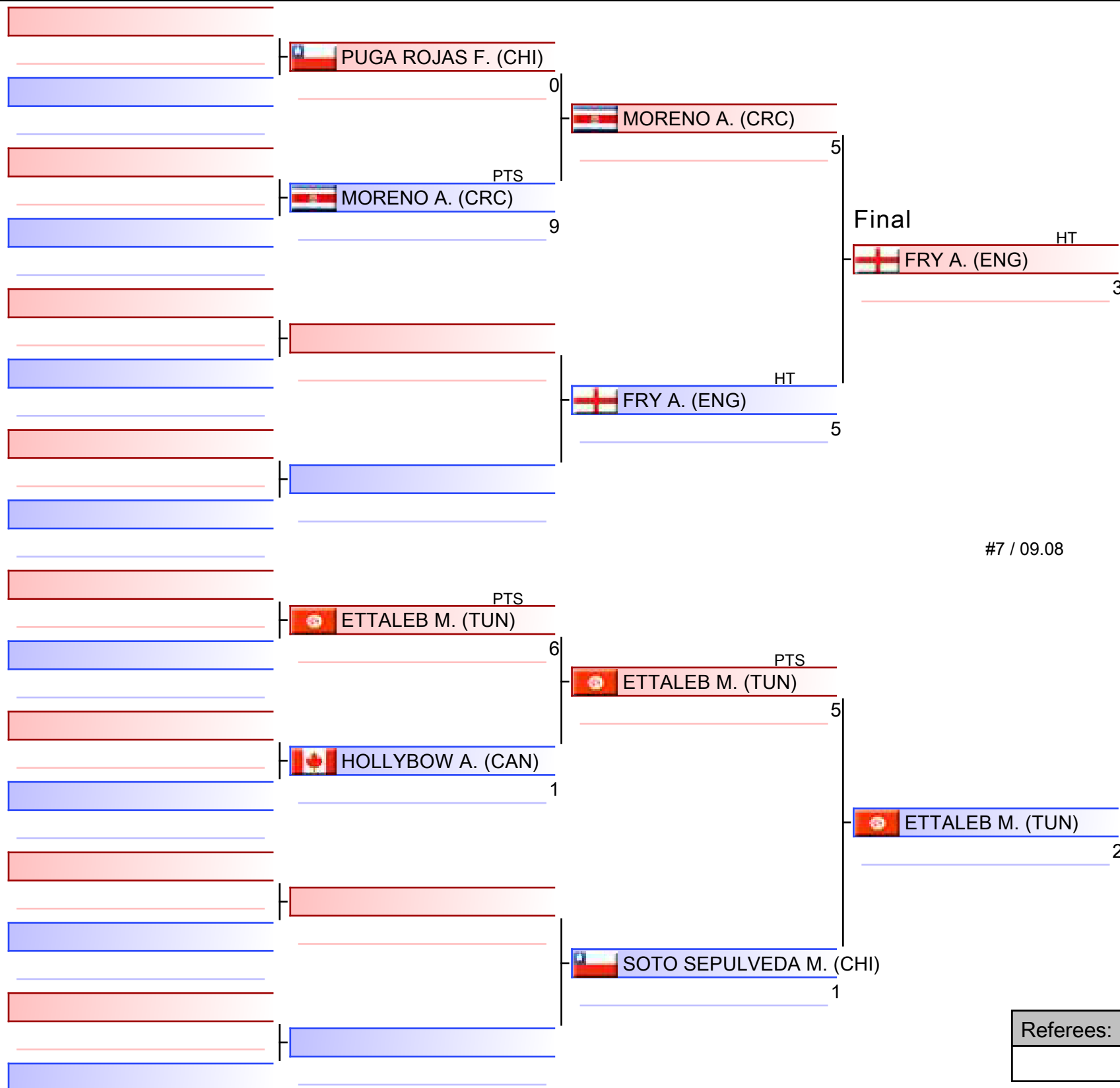

1. FRY AUTUMN (ENG)
2. ETTALEB MERIAME (TUN)
3. MORENO AMANDA (CRC)
3. SOTO SEPULVEDA MARTINA IGNACIA (CHI)
5. HOLLYBOW ANIKA (CAN)

Referees:			

Junior Kumite Female 66+ kg

Karate1 Youth League - Cancun 2024

2024-08-09

Tatami
3 12:40

Pool
1

(c)sportdata GmbH & Co KG 2000-2024 (2024-08-11 14:41) v 10.2.0 build 1 (2024-08-09 20:34 CET) License: Online_Event_ID-875_Karate1YouthLeagueCancun2024 (expire 2024-08-25)

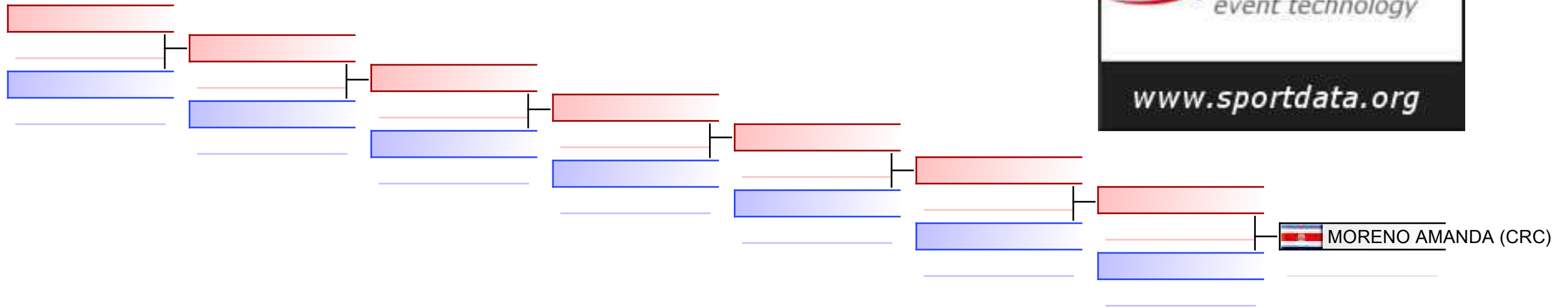

REPECHAGE: (1)

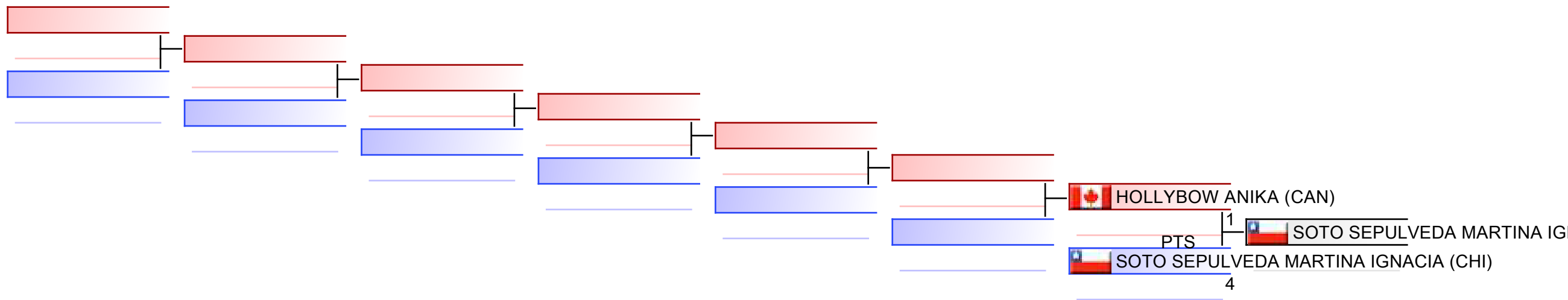

Referees:							
-----------	--	--	--	--	--	--	--



Karate1 Youth League - Cancun 2024 - 2024-08-08



Official Results

Junior Kumite Female 66+ kg			
1	FRY AUTUMN		ENG - ENGLAND
2	ETTALEB MERIAME		TUN - TUNISIA
3	MORENO AMANDA		CRC - COSTA RICA
3	SOTO SEPULVEDA MARTINA IGNACIA		CHI - CHILE
5	HOLLYBOW ANIKA		CAN - CANADA

JUNIOR KUMITE MALE -55 KG



Karate1 Youth League - Cancun 2024
ENTRIES BY WEIGHT CATEGORY



Junior Kumite Male -55 kg
As of 11 AUG 2024

NOC Code	Gender	Name	Seeding
CAN	M	RATHNAYAKE HELITHA	
CHI	M	aguilera Martin	
CHI	M	HERMOSILLA KIRSTEN CRISTOBAL	
CRC	M	PALMA GABRIEL	
ENG	M	Black Joseph	
MEX	M	ARTEAGA ESCALERA RICARDO	
MEX	M	CRUZ ROMERO DANIEL ALEJANDRO	
MEX	M	ESCOBAR CASILLAS PATRICK ALEXANDER	
MEX	M	FREGOSO SUINAGA IKER	
MEX	M	PONCE SANCHEZ FABBIO ALESSANDRO	
MEX	M	Torres García Cesar Emiliano	
PAR	M	FLORENTIN IVAN	
POL	M	OLICHWER NATAN	
POR	M	Fernandes Santiago Pinéu	
PUR	M	Montañes Adorno Arturo Andres	
USA	M	Ochoa Ken	

Junior Kumite Male -55 kg

Karate1 Youth League - Cancun 2024, Iberostar Playa Paraíso Convention Center, Avenida del Sol Km 309, Playa Paraiso, 77710 Riviera Maya, MEX

2024-08-09

Tatami
3 11:25

Pool
1/2

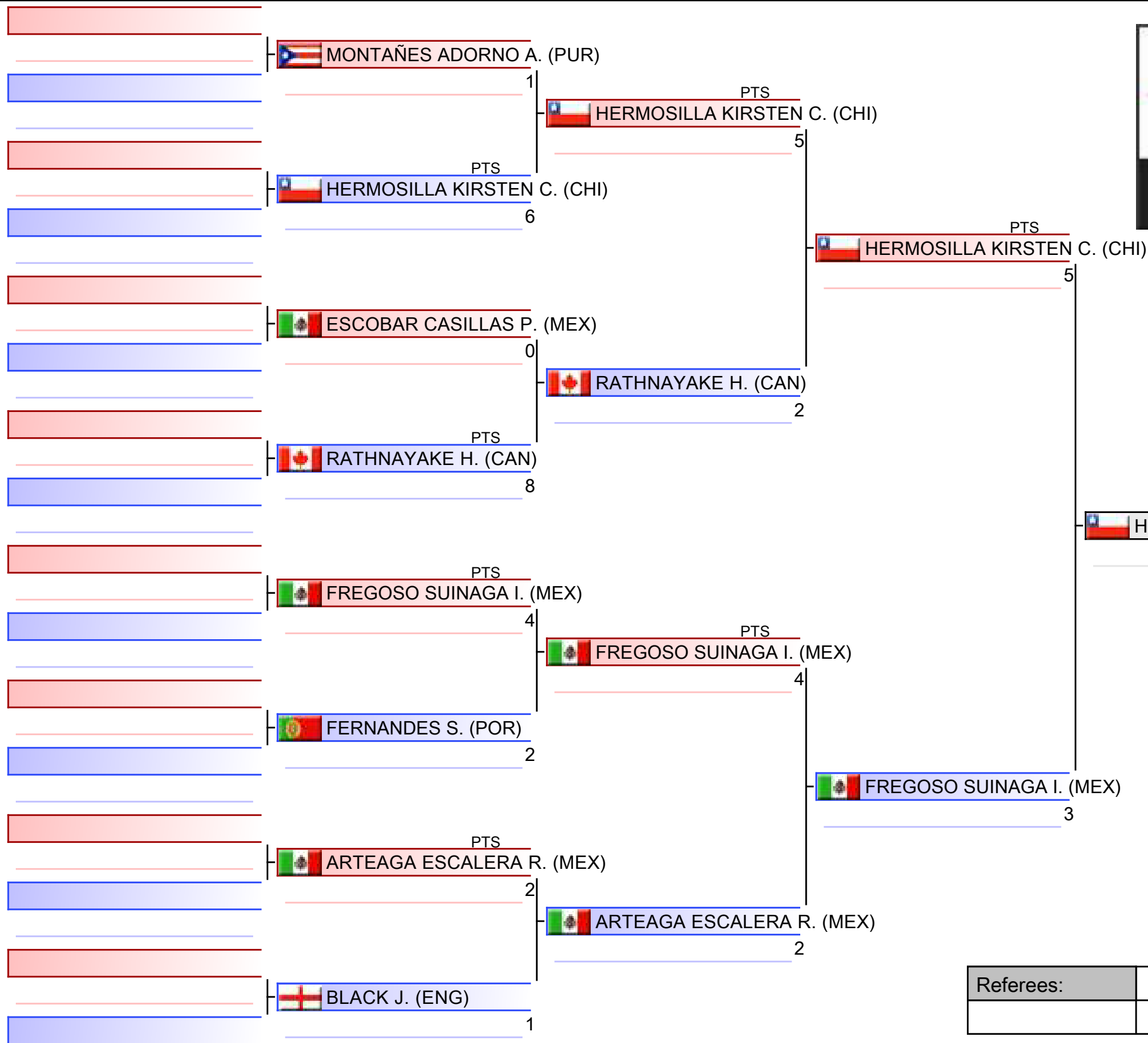

1. CRUZ ROMERO DANIEL ALEJANDRO (MEX)
2. HERMOSILLA KIRSTEN CRISTOBAL (CHI)
3. OCHOA KEN (USA)
3. RATHNAYAKE HELITHA (CAN)
5. AGUILERA MARTIN (CHI)
5. FREGOSO SUINAGA IKER (MEX)
7. FLORENTIN IVAN (PAR)
7. MONTAÑES ADORNO ARTURO ANDRES (PUR)

Referees:			

Junior Kumite Male -55 kg

Karate1 Youth League - Cancun 2024, Iberostar Playa Paraíso Convention Center, Avenida del Sol Km 309, Playa Paraiso, 77710 Riviera Maya, MEX

2024-08-09

Tatami
4 11:25

Pool
2/2

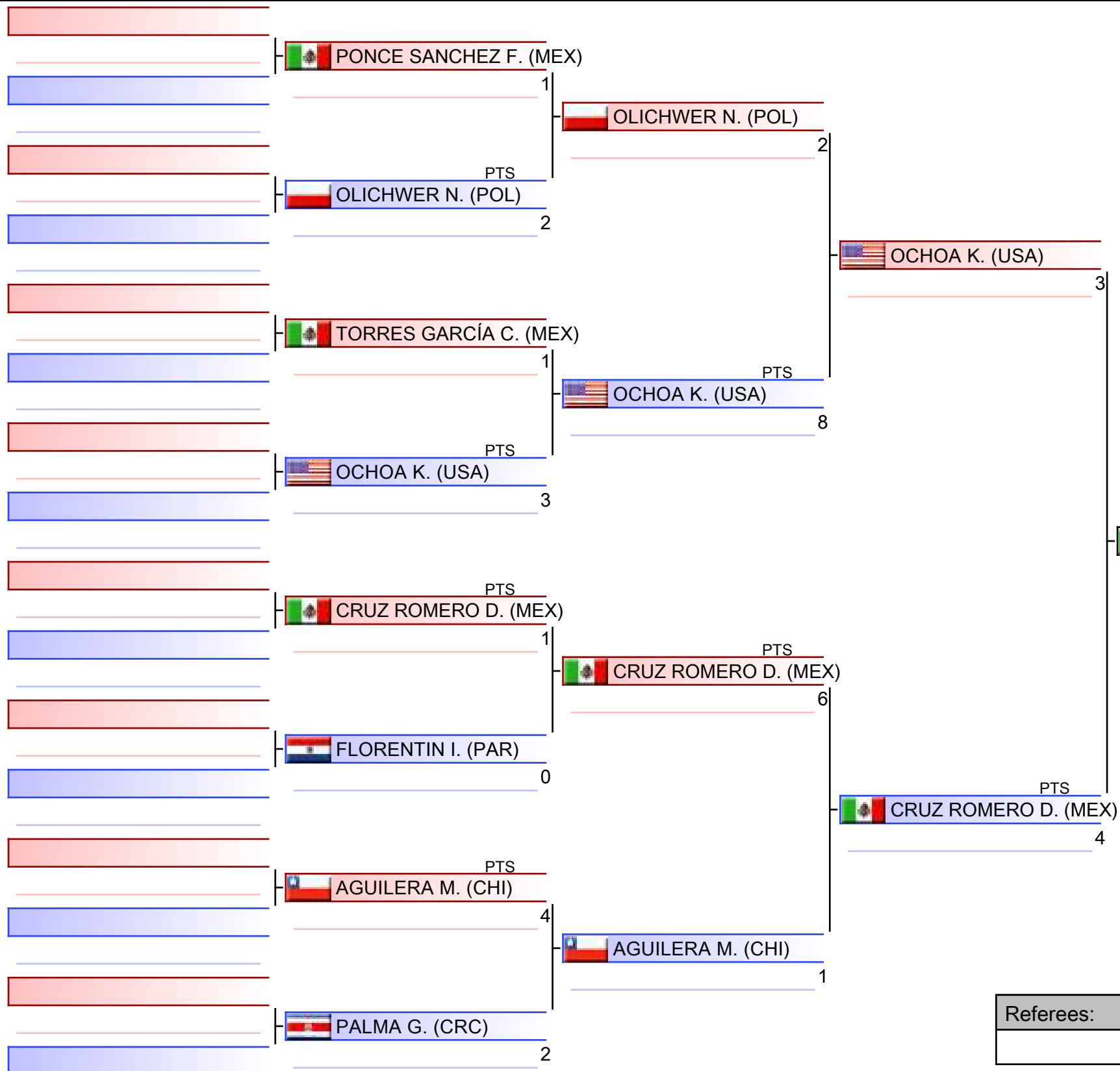

CRUZ ROMERO D. (MEX)

1. CRUZ ROMERO DANIEL ALEJANDRO (MEX)
2. HERMOSILLA KIRSTEN CRISTOBAL (CHI)
3. OCHOA KEN (USA)
3. RATHNAYAKE HELITHA (CAN)
5. AGUILERA MARTIN (CHI)
5. FREGOSO SUINAGA IKER (MEX)
7. FLORENTIN IVAN (PAR)
7. MONTAÑES ADORNO ARTURO ANDRÉS (PUR)

Referees:			

Pool winner-Junior Kumite Male -55 kg

Karate1 Youth League - Cancun 2024, Iberostar Playa Paraíso Convention Center, Avenida del Sol Km 309, Playa Paraiso, 77710 Riviera Maya, MEX

Tatami

Pool

1/1

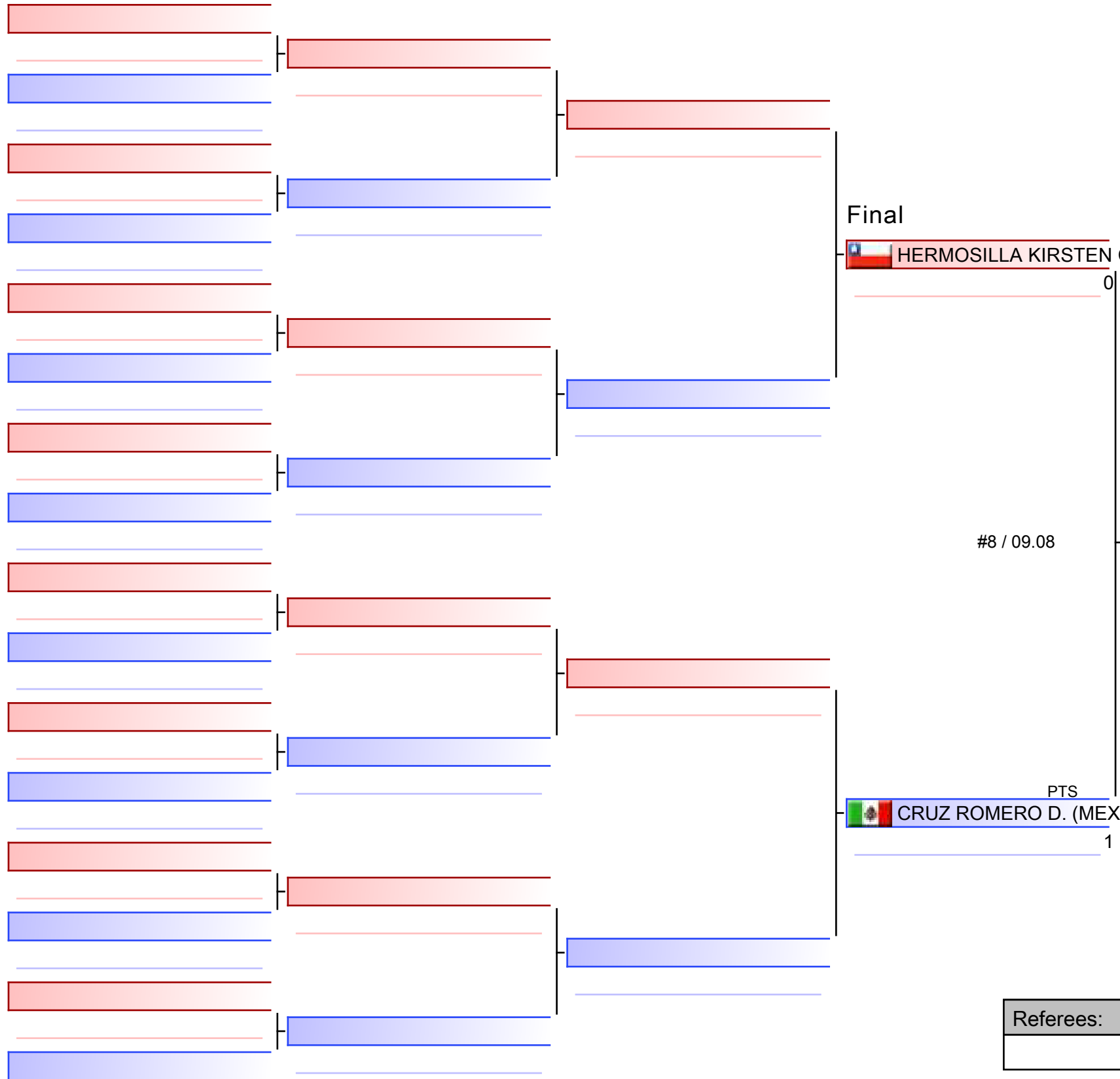

Final

HERMOSILLA KIRSTEN C. (CHI)

0

#8 / 09.08

CRUZ ROMERO D. (MEX)

PTS

CRUZ ROMERO D. (MEX)

1

- | |
|--|
| 1. CRUZ ROMERO DANIEL ALEJANDRO (MEX) |
| 2. HERMOSILLA KIRSTEN CRISTOBAL (CHI) |
| 3. OCHOA KEN (USA) |
| 3. RATHNAYAKE HELITHA (CAN) |
| 5. AGUILERA MARTIN (CHI) |
| 5. FREGOSO SUINAGA IKER (MEX) |
| 7. FLORENTIN IVAN (PAR) |
| 7. MONTAÑES ADORNO ARTURO ANDRES (PUR) |

Referees:			

Junior Kumite Male -55 kg

Karate1 Youth League - Cancun 2024

2024-08-09

Tatami
3 12:00

Pool
1,2

(c)sportdata GmbH & Co KG 2000-2024 (2024-08-11 14:41) v 10.2.0 build 1 (2024-08-09 20:34 CET) License: Online_Event_ID-875_Karate1YouthLeagueCancun2024 (expire 2024-08-25)

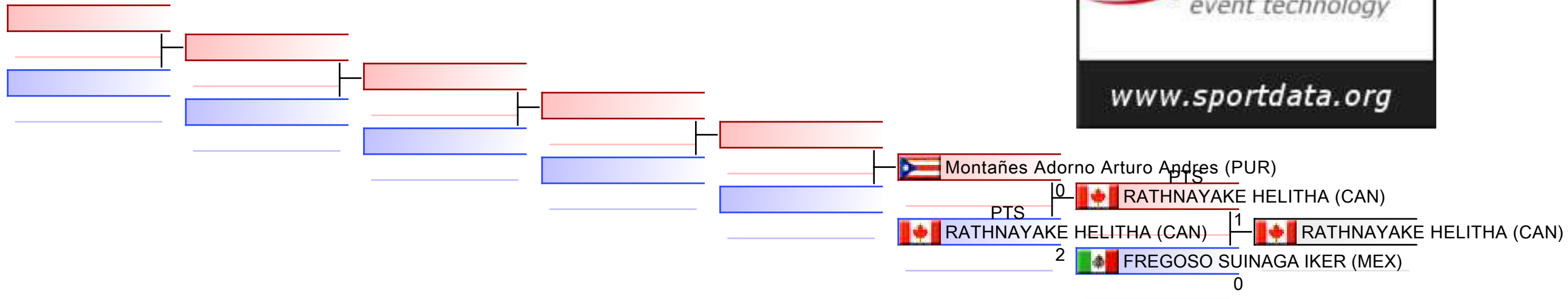

REPECHAGE: (1,2)

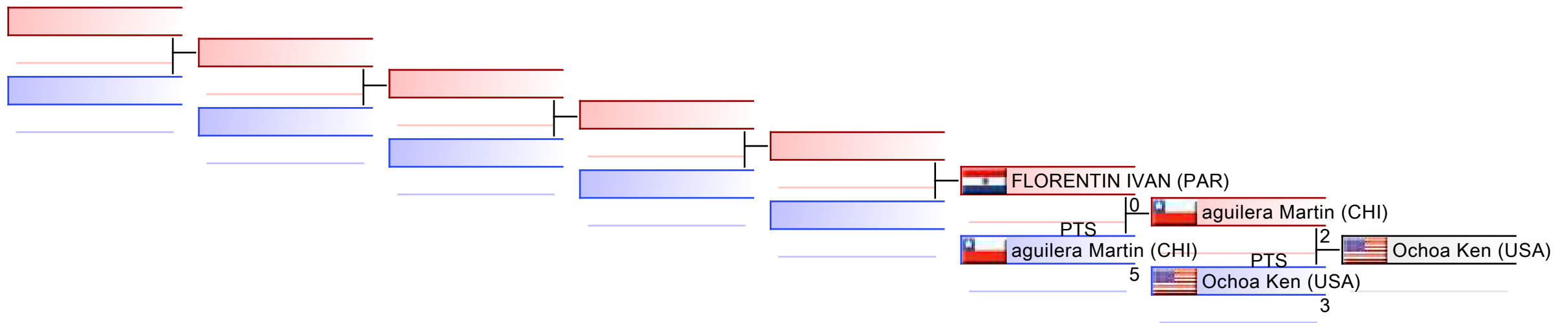

Referees:							
-----------	--	--	--	--	--	--	--



Karate1 Youth League - Cancun 2024 - 2024-08-08



Official Results

Junior Kumite Male -55 kg			
1	CRUZ ROMERO DANIEL ALEJANDRO		MEX - MEXICO
2	HERMOSILLA KIRSTEN CRISTOBAL		CHI - CHILE
3	OCHOA KEN		USA - UNITED STATES
3	RATHNAYAKE HELITHA		CAN - CANADA
5	AGUILERA MARTIN		CHI - CHILE
5	FREGOSO SUINAGA IKER		MEX - MEXICO
7	FLORENTIN IVAN		PAR - PARAGUAY
7	MONTAÑES ADORNO ARTURO ANDRES		PUR - PUERTO RICO

JUNIOR KUMITE MALE -61 KG



Karate1 Youth League - Cancun 2024
ENTRIES BY WEIGHT CATEGORY



Junior Kumite Male -61 kg
As of 11 AUG 2024

NOC Code	Gender	Name	Seeding
BEL	M	ROMBEAUX MATT	
BRA	M	Assunção João	
CAN	M	Lee Christopher	
CHI	M	ARAOS SAGREDO MARTIN	
CHI	M	BAHAMONDE MARTIN	
COL	M	BOHORQUEZ CAUSIL JOSE LUIS	
COL	M	TOLEDO SEBASTIAN	
CRC	M	RODRIGUEZ DANIEL	
CRO	M	Mabić Filip	
ECU	M	CHUCHUCA JARED	
ENG	M	Attard Zachary	
ESP	M	MUÑOZ MACIAS LUIS	
GRE	M	KARRAS PETROS	
MEX	M	CORONA VAZQUEZ IVAN ALEJANDRO	
MEX	M	DE LA TORRE ROBLEDO LEONARDO	
MEX	M	DELGADO SANCHEZ ALFONSO ANDRE	
MEX	M	DOMINGUEZ HERNANDEZ ANGEL JULIAN	
MEX	M	GOMEZ GONZALEZ JOSHUA ALI	
MEX	M	REBOLLEDO BRAVO ANDRE SALVADOR	
MEX	M	VELAZQUEZ OSUNA SERGIO EDUARDO	
PAR	M	LOPEZ ENZO	
PER	M	Alvarez Romero Emanuel	
SUI	M	Debost Gaspard	
USA	M	Blunck August	
USA	M	Cruz Bryan	
USA	M	Lopez Zack	
USA	M	Nacu Mateo	
USA	M	Serafimovich Lucas	

Junior Kumite Male -61 kg

Karate1 Youth League - Cancun 2024, Iberostar Playa Paraíso Convention Center, Avenida del Sol Km 309, Playa Paraiso, 77710 Riviera Maya, MEX

2024-08-09

Tatami

3 12:50

Pool

1/2

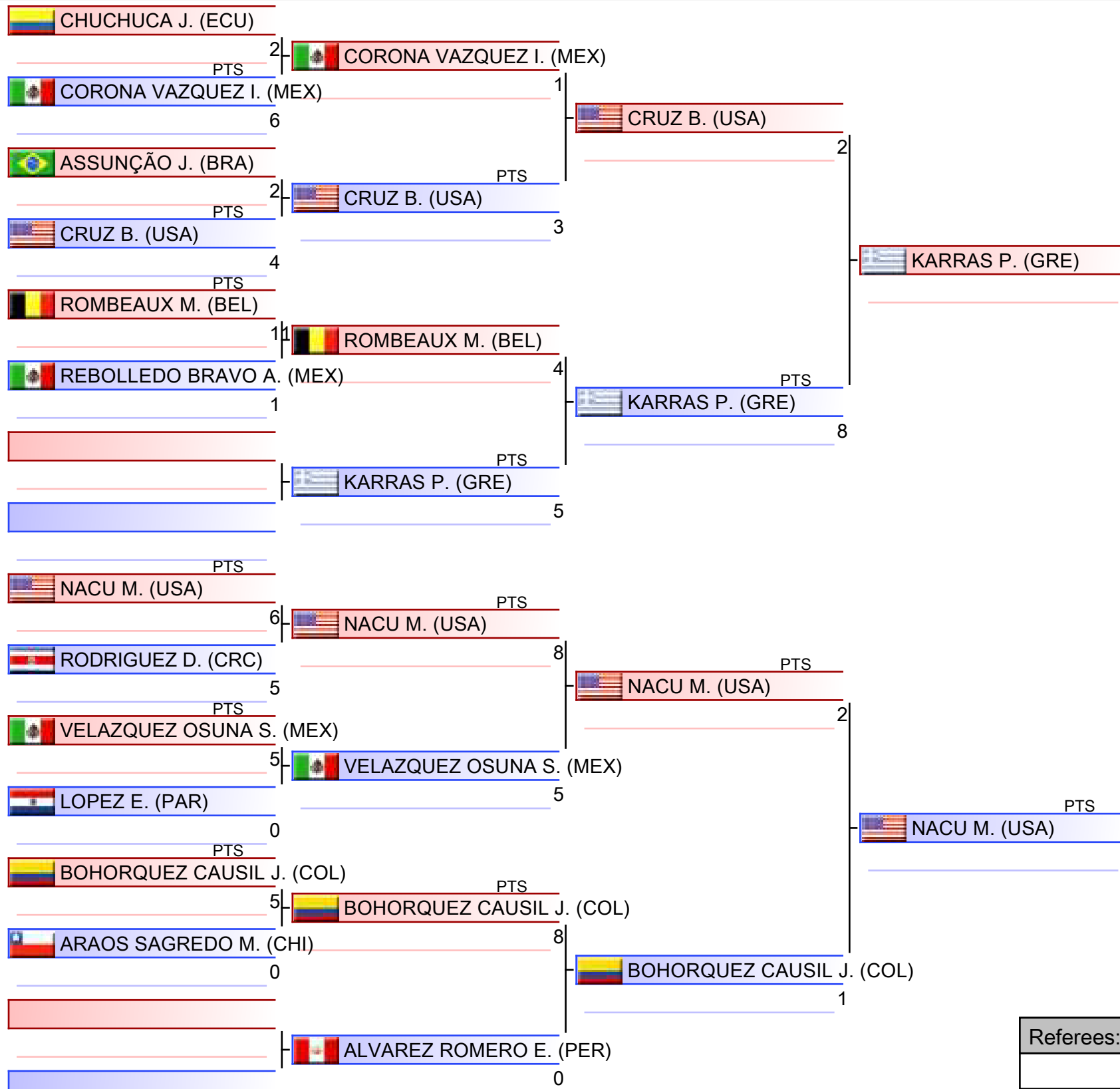

1. NACU MATEO (USA)
2. LOPEZ ZACK (USA)
3. KARRAS PETROS (GRE)
3. MABIĆ FILIP (CRO)
5. RODRIGUEZ DANIEL (CRC)
5. TOLEDO SEBASTIAN (COL)
7. BOHORQUEZ CAUSIL JOSE LUIS (COL)
7. BLUNCK AUGUST (USA)

Referees:			

Junior Kumite Male -61 kg

Karate1 Youth League - Cancun 2024, Iberostar Playa Paraíso Convention Center, Avenida del Sol Km 309, Playa Paraiso, 77710 Riviera Maya, MEX

2024-08-09

Tatami

4 13:00

Pool

2/2

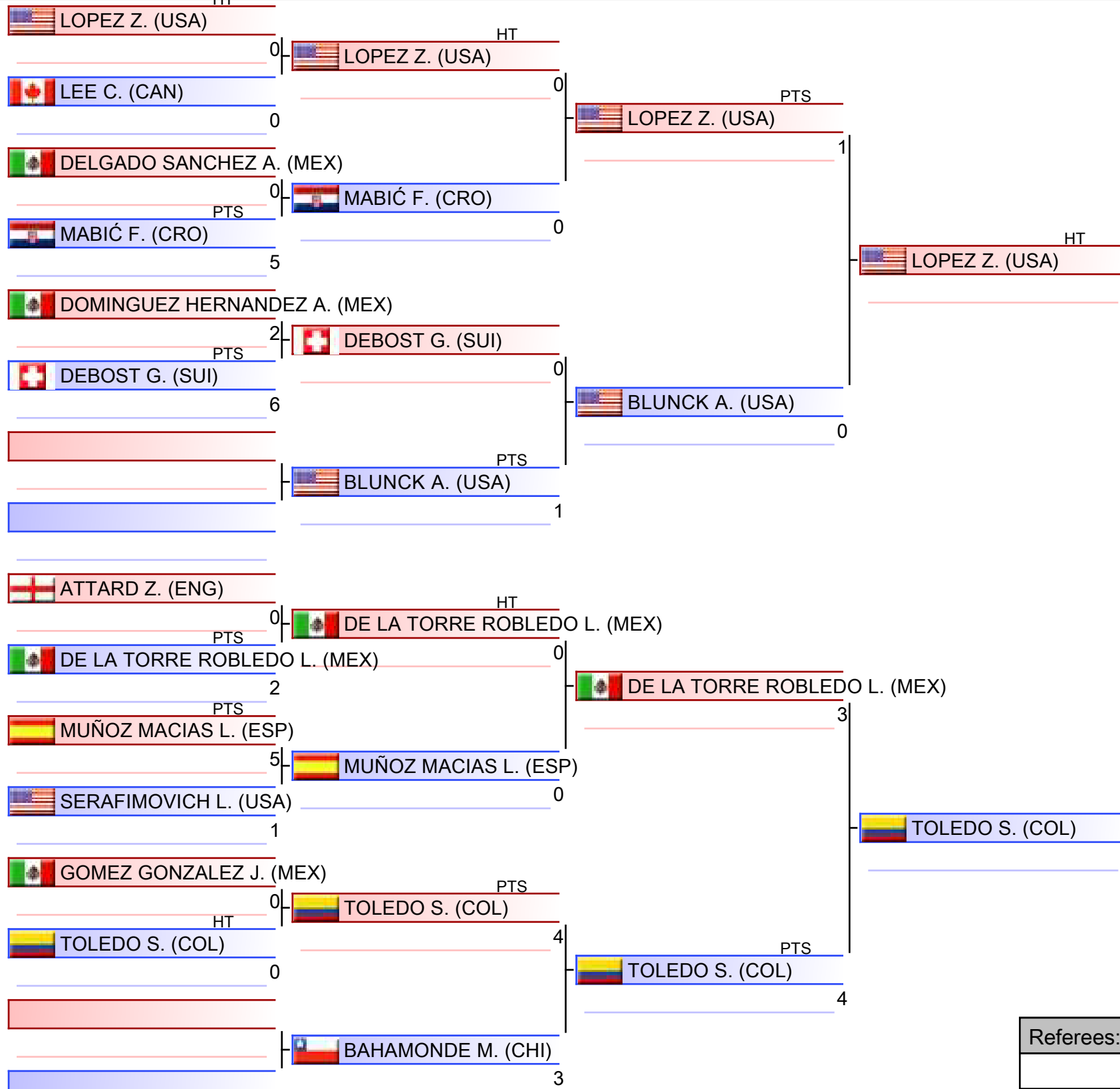

LOPEZ Z. (USA)

1. NACU MATEO (USA)
2. LOPEZ ZACK (USA)
3. KARRAS PETROS (GRE)
3. MABIĆ FILIP (CRO)
5. RODRIGUEZ DANIEL (CRC)
5. TOLEDO SEBASTIAN (COL)
7. BOHORQUEZ CAUSIL JOSE LUIS (COL)
7. BLUNCK AUGUST (USA)

Referees:			

Pool winner-Junior Kumite Male -61 kg

Karate1 Youth League - Cancun 2024, Iberostar Playa Paraíso Convention Center, Avenida del Sol Km 309, Playa Paraiso, 77710 Riviera Maya, MEX

Tatami

Pool

1/1

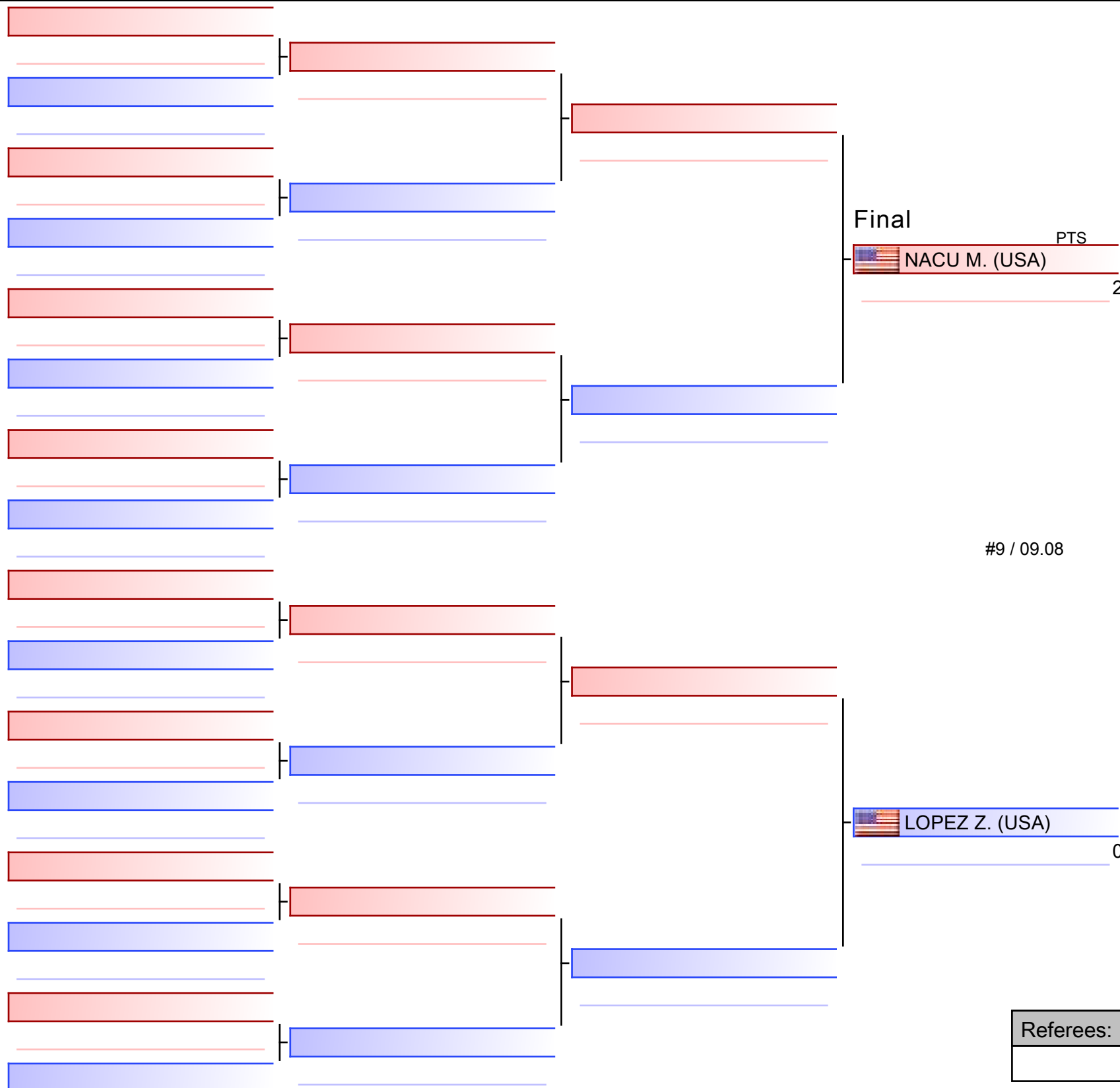

Final

PTS

NACU M. (USA) 2

#9 / 09.08

NACU M. (USA)

LOPEZ Z. (USA) 0

1. NACU MATEO (USA)
2. LOPEZ ZACK (USA)
3. KARRAS PETROS (GRE)
3. MABIĆ FILIP (CRO)
5. RODRIGUEZ DANIEL (CRC)
5. TOLEDO SEBASTIAN (COL)
7. BOHORQUEZ CAUSIL JOSE LUIS (COL)
7. BLUNCK AUGUST (USA)

Referees:			

Junior Kumite Male -61 kg

Karate1 Youth League - Cancun 2024

2024-08-09

Tatami
3 13:55

Pool
1

(c)sportdata GmbH & Co KG 2000-2024 (2024-08-11 14:41) v 10.2.0 build 1 (2024-08-09 20:34 CET) License: Online_Event_ID-875_Karate1YouthLeagueCancun2024 (expire 2024-08-25)

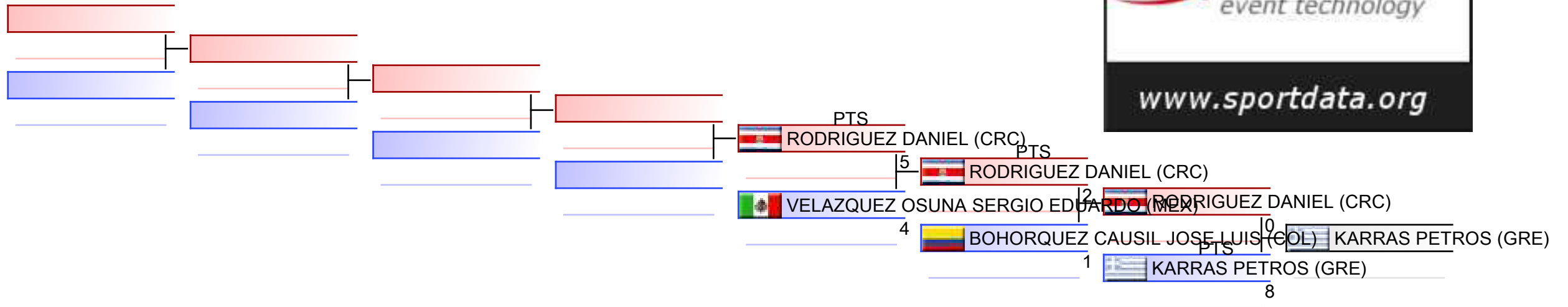

REPECHAGE: (1)

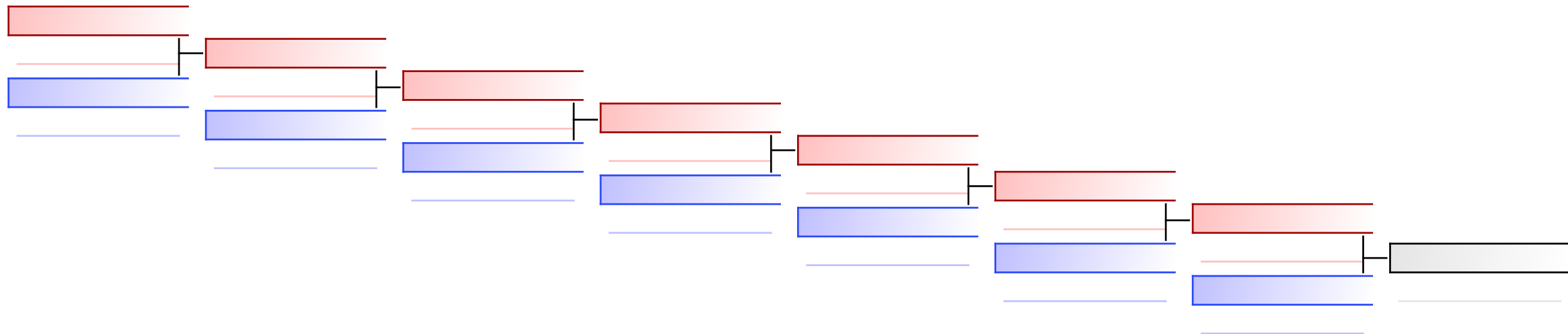

Referees:							
-----------	--	--	--	--	--	--	--

Junior Kumite Male -61 kg

Karate1 Youth League - Cancun 2024

2024-08-09

Tatami
4 14:05

Pool
2

(c)sportdata GmbH & Co KG 2000-2024 (2024-08-11 14:41) v 10.2.0 build 1 (2024-08-09 20:34 CET) License: Online_Event_ID-875_Karate1YouthLeagueCancun2024 (expire 2024-08-25)

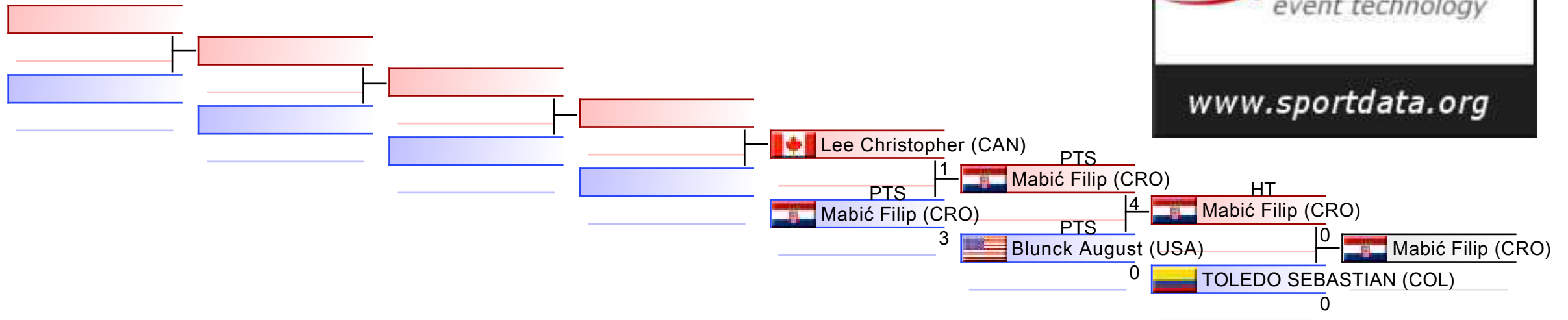

REPECHAGE: (2)

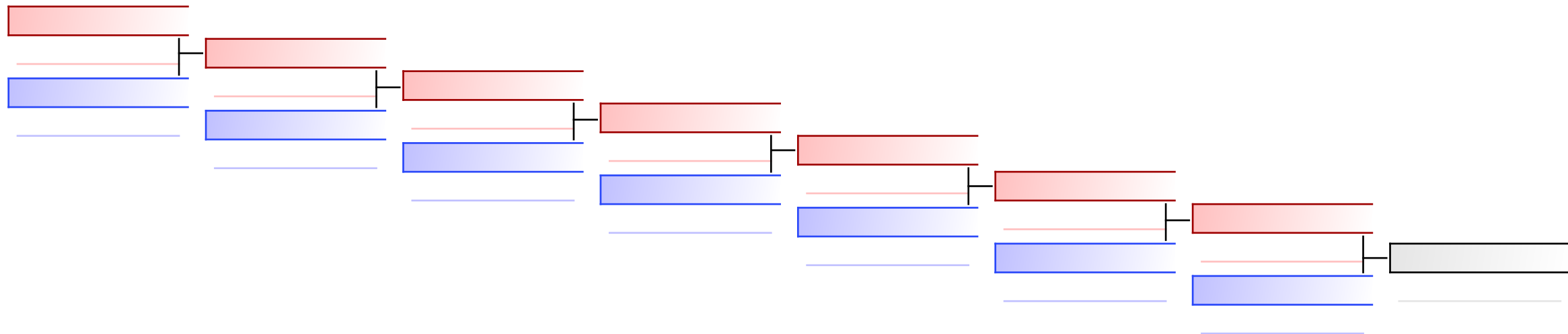

Referees:							
-----------	--	--	--	--	--	--	--



Karate1 Youth League - Cancun 2024 - 2024-08-08



Official Results

Junior Kumite Male -61 kg			
1	NACU MATEO		USA - UNITED STATES
2	LOPEZ ZACK		USA - UNITED STATES
3	KARRAS PETROS		GRE - GREECE
3	MABIĆ FILIP		CRO - CROATIA
5	RODRIGUEZ DANIEL		CRC - COSTA RICA
5	TOLEDO SEBASTIAN		COL - COLOMBIA
7	BOHORQUEZ CAUSIL JOSE LUIS		COL - COLOMBIA
7	BLUNCK AUGUST		USA - UNITED STATES
9	VELAZQUEZ OSUNA SERGIO EDUARDO		MEX - MEXICO
9	LEE CHRISTOPHER		CAN - CANADA

JUNIOR KUMITE MALE -68 KG



Karate1 Youth League - Cancun 2024
ENTRIES BY WEIGHT CATEGORY



Junior Kumite Male -68 kg
As of 11 AUG 2024

NOC Code	Gender	Name	Seeding
ARU	M	BOEKHOUDT NATHAN	
AUT	M	PLATISA PASCAL	
CHI	M	ADRIAZOLA REYES BENJAMIN	
CHI	M	CALISTO GASPAR	
CHI	M	Carvajal Vergara Leonardo José	
CHI	M	Mondaca Rivera Esteban Vicente Andres	
CHI	M	PAVEZ ALONSO	
CRC	M	ABELLAN ORLANDO	
ENG	M	Wilkins Logan	
GER	M	Heller Ben	
GER	M	Thierbach Luca	
ITA	M	CITI JACOPO	
ITA	M	TONIOLO ALVISE	
LAT	M	Ritenieks Oliveris	
MEX	M	ANDRADE MARTINEZ OWEN	
MEX	M	BARAJAS ORTEGA EMILIANO	
MEX	M	GARCÍA SANCHEZ DIEGO	
MEX	M	MERINO HERNADEZ JOSUE JACOB	
MEX	M	OROZCO GALICIA DANTE ALEJANDRO	
NCA	M	JULIO ROMERO BERMUDEZ	
PAR	M	SANCHEZ DARDO	
PER	M	Urbina Carranza Gonzalo	
ROU	M	BOGZA GABRIEL	
SUI	M	Lorenz Swan	
USA	M	Corao Luis	
USA	M	River Ariel	

Junior Kumite Male -68 kg

Karate1 Youth League - Cancun 2024, Iberostar Playa Paraíso Convention Center, Avenida del Sol Km 309, Playa Paraiso, 77710 Riviera Maya, MEX

2024-08-09

Tatami
3 14:10

Pool
1/2

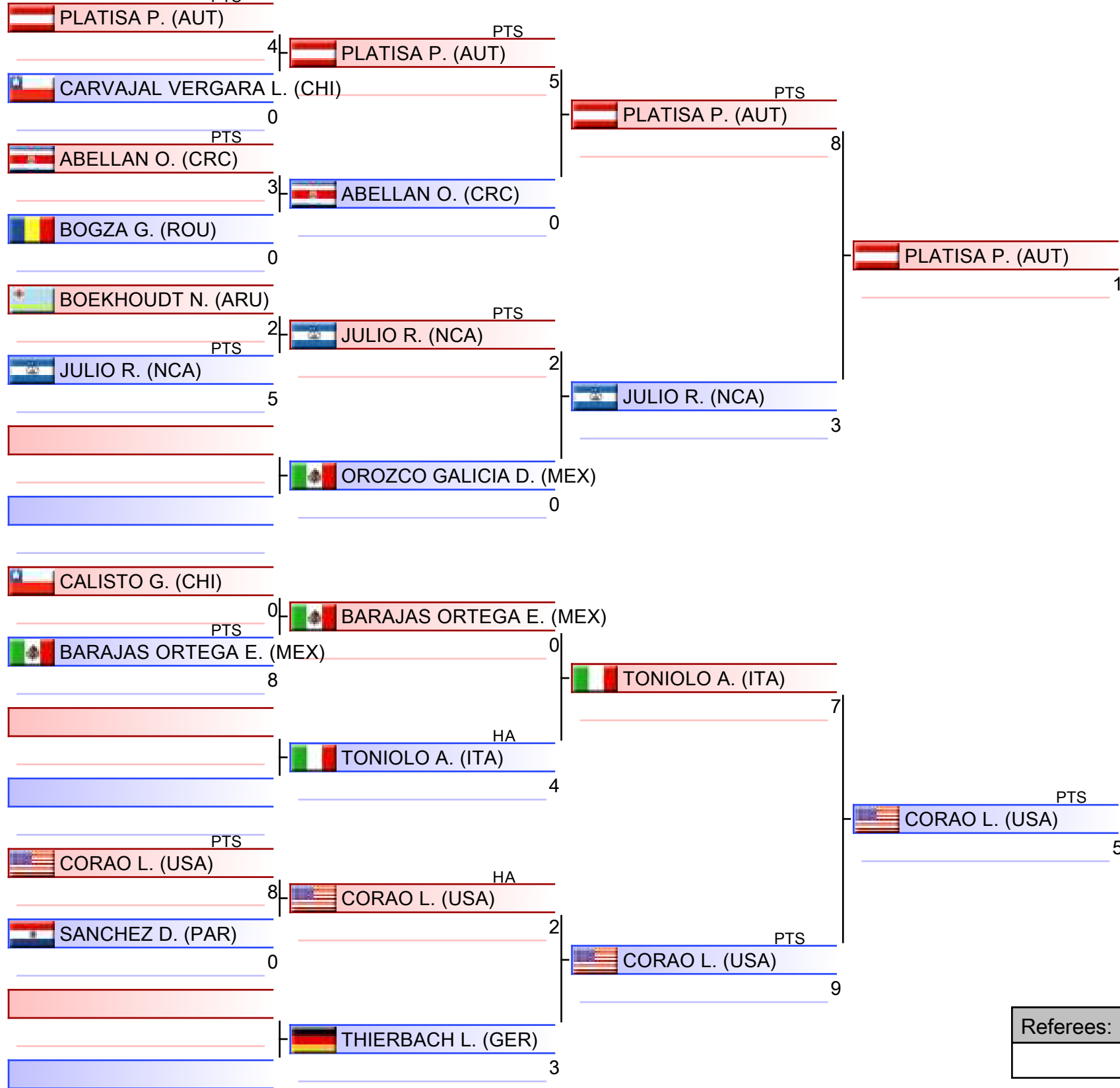

1. CORAO LUIS (USA)
2. HELLER BEN (GER)
3. TONIOLO ALVISE (ITA)
3. PAVEZ ALONSO (CHI)
5. PLATISA PASCAL (AUT)
5. LORENZ SWAN (SUI)
7. SANCHEZ DARDO (PAR)
7. ADRIAZOLA REYES BENJAMIN (CHI)

Referees:			

Junior Kumite Male -68 kg

Karate1 Youth League - Cancun 2024, Iberostar Playa Paraíso Convention Center, Avenida del Sol Km 309, Playa Paraiso, 77710 Riviera Maya, MEX

2024-08-09

Tatami
4 14:20

Pool
2/2

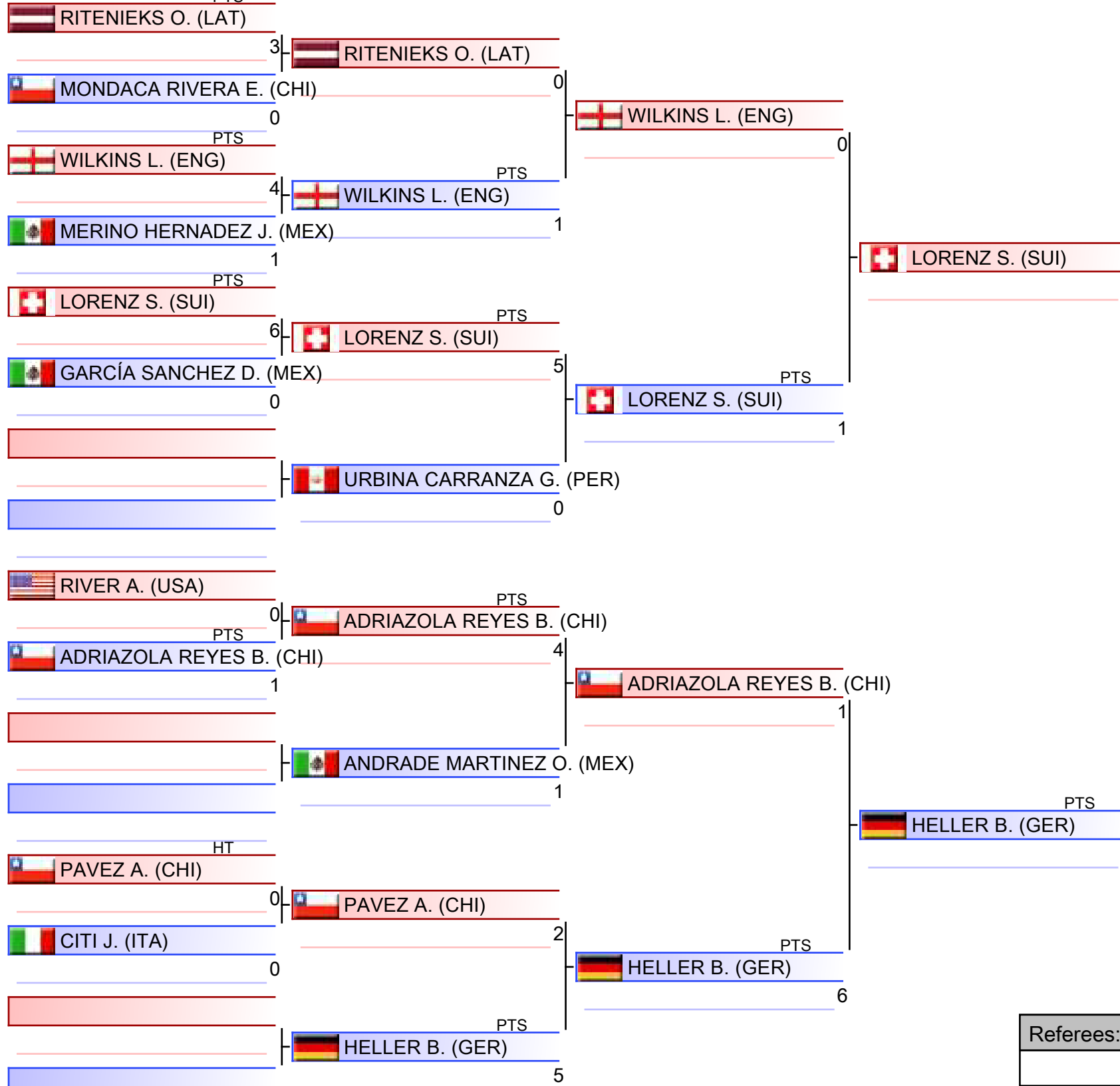

1. CORAO LUIS (USA)
2. HELLER BEN (GER)
3. TONIOLO ALVISE (ITA)
3. PAVEZ ALONSO (CHI)
5. PLATISA PASCAL (AUT)
5. LORENZ SWAN (SUI)
7. SANCHEZ DARDO (PAR)
7. ADRIAZOLA REYES BENJAMIN (CHI)

Referees:			

Pool winner-Junior Kumite Male -68 kg

Karate1 Youth League - Cancun 2024, Iberostar Playa Paraíso Convention Center, Avenida del Sol Km 309, Playa Paraiso, 77710 Riviera Maya, MEX

Tatami

Pool

1/1

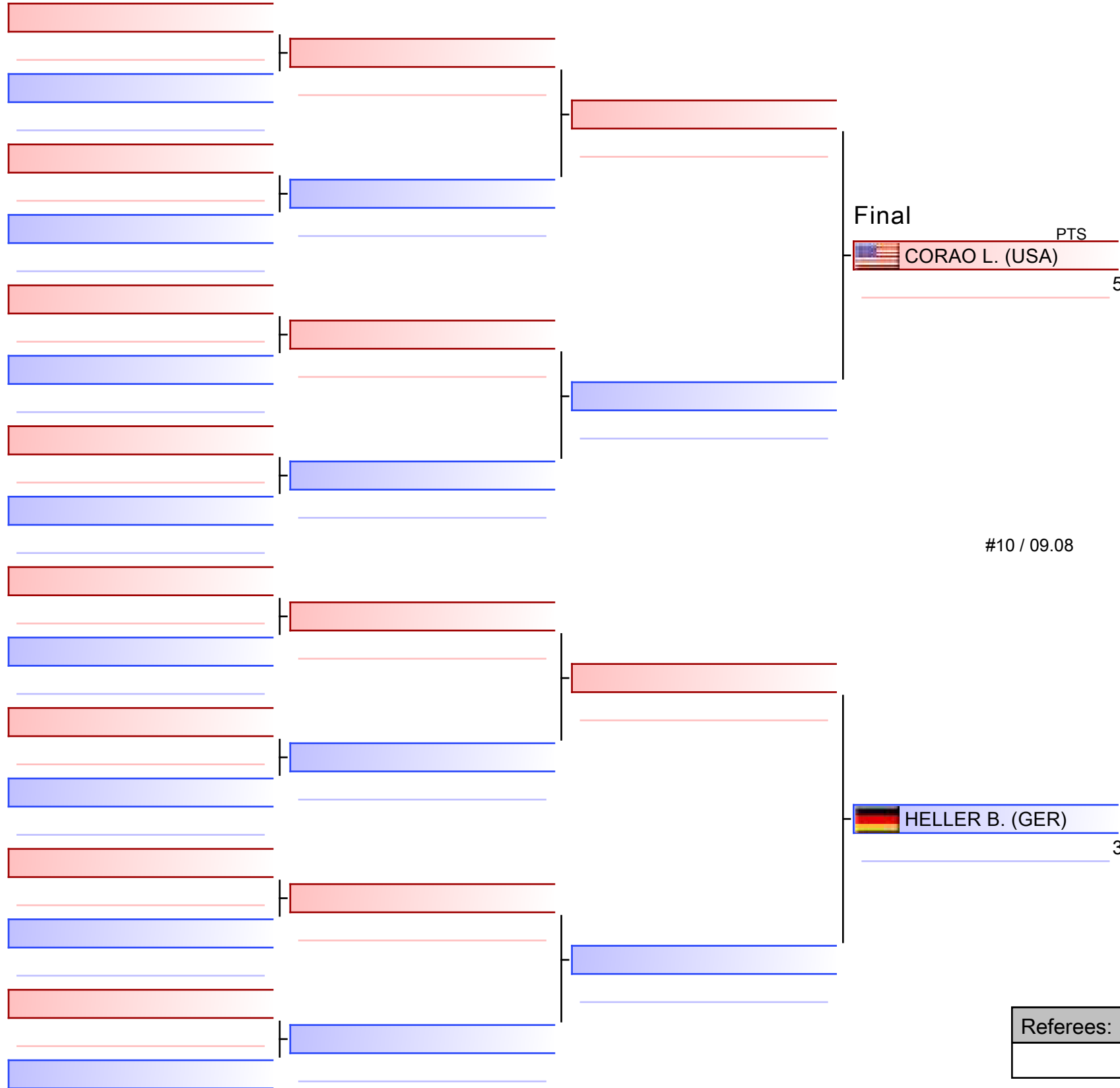

Final

PTS

CORAO L. (USA) 5

#10 / 09.08

CORAO L. (USA)

HELLER B. (GER) 3

- | |
|-----------------------------------|
| 1. CORAO LUIS (USA) |
| 2. HELLER BEN (GER) |
| 3. TONIOLO ALVISE (ITA) |
| 3. PAVEZ ALONSO (CHI) |
| 5. PLATISA PASCAL (AUT) |
| 5. LORENZ SWAN (SUI) |
| 7. SANCHEZ DARDO (PAR) |
| 7. ADRIAZOLA REYES BENJAMIN (CHI) |

Referees:			

Junior Kumite Male -68 kg

Karate1 Youth League - Cancun 2024

2024-08-09

Tatami
3 15:10

Pool
1

(c)sportdata GmbH & Co KG 2000-2024 (2024-08-11 14:41) v 10.2.0 build 1 (2024-08-09 20:34 CET) License: Online_Event_ID-875_Karate1YouthLeagueCancun2024 (expire 2024-08-25)

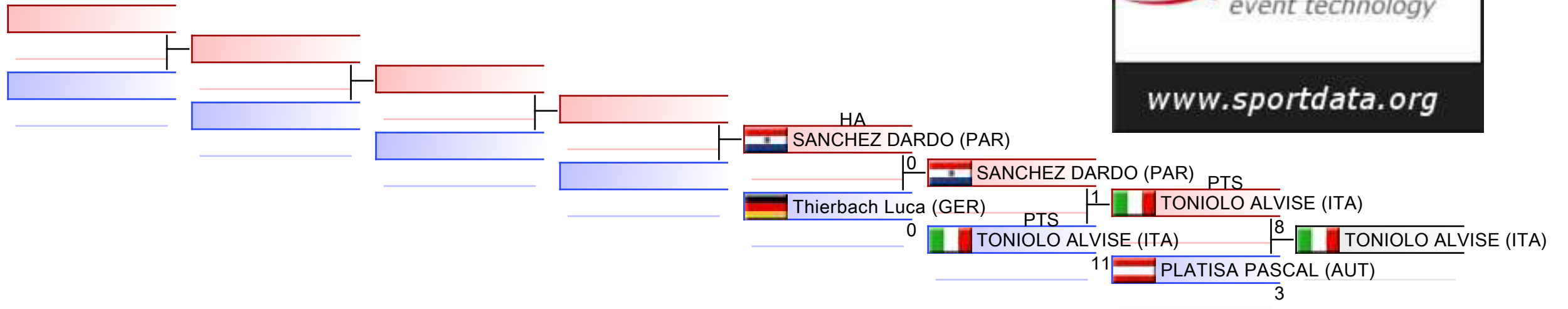

REPECHAGE: (1)

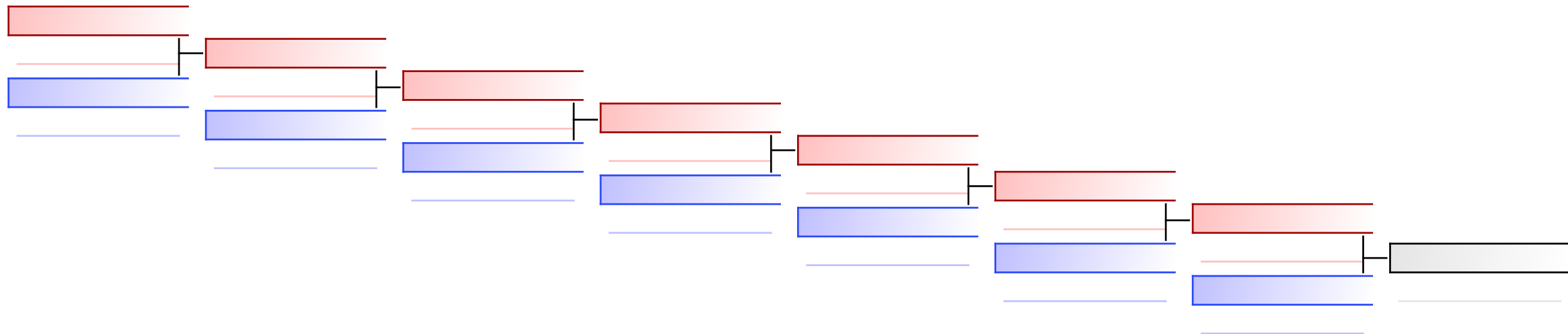

Referees:							
-----------	--	--	--	--	--	--	--

Junior Kumite Male -68 kg

Karate1 Youth League - Cancun 2024

2024-08-09

Tatami
4 15:20

Pool
2

(c)sportdata GmbH & Co KG 2000-2024 (2024-08-11 14:41) v 10.2.0 build 1 (2024-08-09 20:34 CET) License: Online_Event_ID-875_Karate1YouthLeagueCancun2024 (expire 2024-08-25)

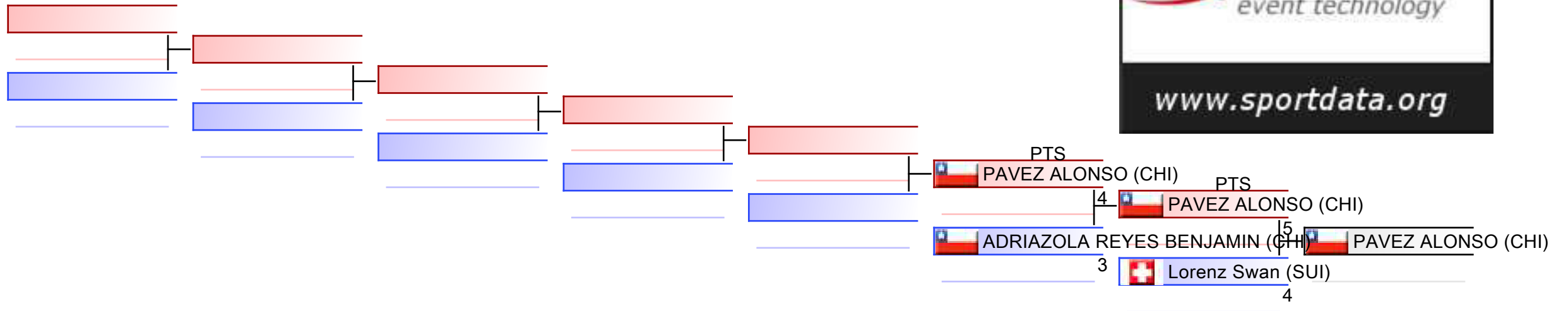

REPECHAGE: (2)

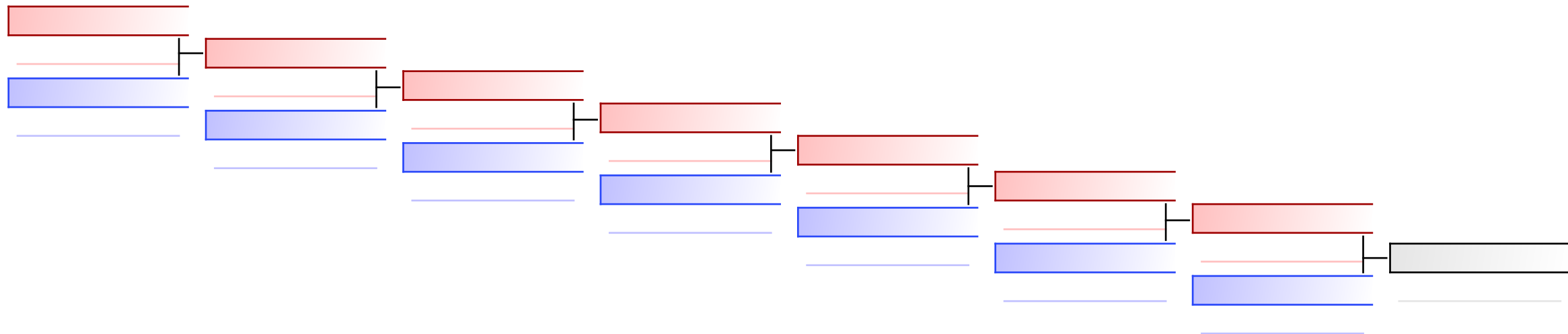

Referees:							
-----------	--	--	--	--	--	--	--



Karate1 Youth League - Cancun 2024 - 2024-08-08



Official Results

Junior Kumite Male -68 kg			
1	CORAO LUIS		USA - UNITED STATES
2	HELLER BEN		GER - GERMANY
3	TONIOLO ALVISE		ITA - ITALY
3	PAVEZ ALONSO		CHI - CHILE
5	PLATISA PASCAL		AUT - AUSTRIA
5	LORENZ SWAN		SUI - SWITZERLAND
7	SANCHEZ DARDO		PAR - PARAGUAY
7	ADRIAZOLA REYES BENJAMIN		CHI - CHILE
9	THIERBACH LUCA		GER - GERMANY

JUNIOR KUMITE MALE -76 KG



Karate1 Youth League - Cancun 2024
ENTRIES BY WEIGHT CATEGORY



Junior Kumite Male -76 kg
As of 11 AUG 2024

NOC Code	Gender	Name	Seeding
CAN	M	Danesh Daniel	
CHI	M	CAMINADA CATALÁN PHILLIP ANDREE	
CHI	M	PEÑA RENATO	
COL	M	Olmos quintana matheo	
CRC	M	ARAYA DANIEL	
CRO	M	STRAHIJA SVEN	
ESP	M	Leal Moreno Iker	
GER	M	Knopp Phil	
GER	M	Zuniga Späthe Robin Mateo	
GUA	M	MORALES SERRANO GERSHON ADIR	
MEX	M	MONTANO MORALES EDUARDO	
MEX	M	ORTEGA DESCIDERIO ANGEL JOSUE	
MEX	M	SANCHEZ MONTENEGRO RUBEN	
MEX	M	SANDOVAL SANDOVAL JOSE ANTONIO	
MEX	M	TAPIA SOLANO NICOLAS WINAJEL	
MEX	M	VILLAFANA VARGAS ALAN GERARDO	
MEX	M	ZAVALA MERCADO JOSE JUAN	
NCA	M	MOLINA GARAY MATHEUS	
PUR	M	Molina Ortiz Oscar	
USA	M	Merrell Grayson	
USA	M	Wood Landen	

Junior Kumite Male -76 kg

Karate1 Youth League - Cancun 2024, Iberostar Playa Paraíso Convention Center, Avenida del Sol Km 309, Playa Paraiso, 77710 Riviera Maya, MEX

2024-08-09

Tatami

1 13:55

Pool

1/2

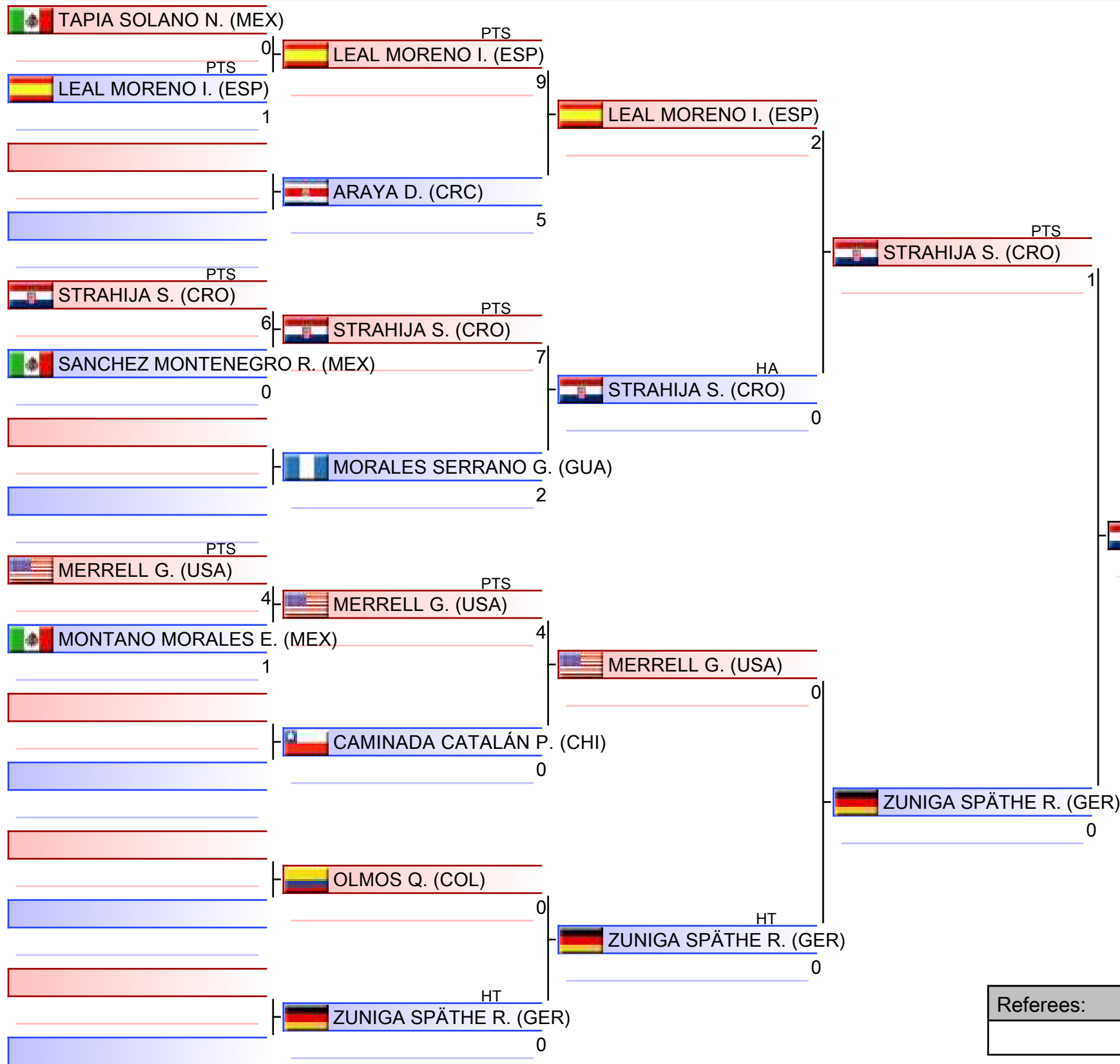

- | |
|---|
| 1. STRAHIJA SVEN (CRO) |
| 2. WOOD LANDEN (USA) |
| 3. LEAL MORENO IKER (ESP) |
| 3. PEÑA RENATO (CHI) |
| 5. ZUNIGA SPÄTHER ROBIN MATEO (GER) |
| 5. SANDOVAL SANDOVAL JOSE ANTONIO (MEX) |
| 7. MORALES SERRANO GERSHON ADIR (GUA) |
| 7. ORTEGA DESCIDERIO ANGEL JOSUE (MEX) |

Referees:			

Junior Kumite Male -76 kg

Karate1 Youth League - Cancun 2024, Iberostar Playa Paraíso Convention Center, Avenida del Sol Km 309, Playa Paraiso, 77710 Riviera Maya, MEX

2024-08-09

Tatami

2 14:10

Pool

2/2

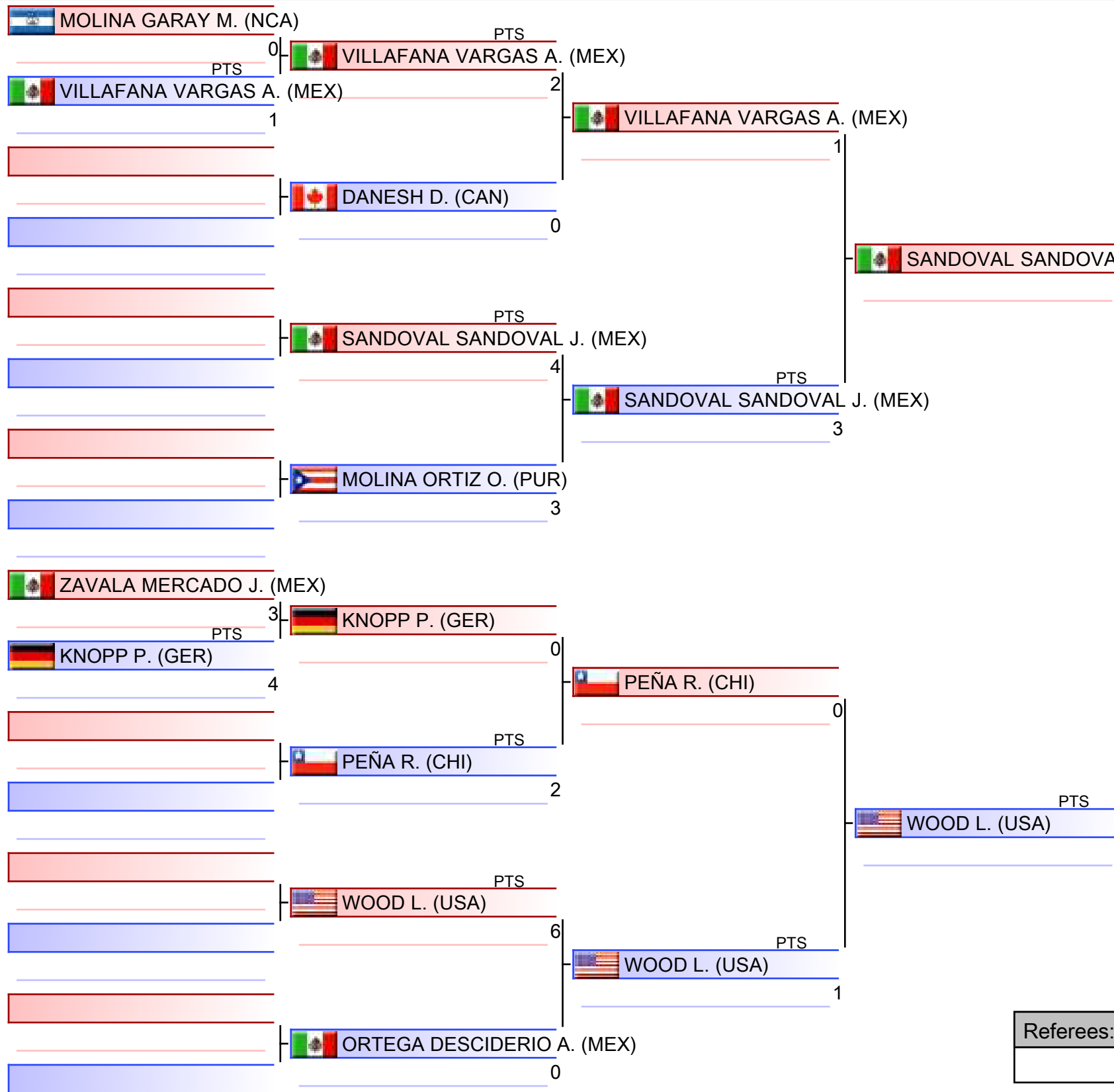

- | |
|---|
| 1. STRAHIIJA SVEN (CRO) |
| 2. WOOD LANDEN (USA) |
| 3. LEAL MORENO IKER (ESP) |
| 3. PEÑA RENATO (CHI) |
| 5. ZUNIGA SPÄTHE ROBIN MATEO (GER) |
| 5. SANDOVAL SANDOVAL JOSE ANTONIO (MEX) |
| 7. MORALES SERRANO GERSHON ADIR (GUA) |
| 7. ORTEGA DESCIDERIO ANGEL JOSUE (MEX) |

Referees:			

Pool winner-Junior Kumite Male -76 kg

Karate1 Youth League - Cancun 2024, Iberostar Playa Paraíso Convention Center, Avenida del Sol Km 309, Playa Paraiso, 77710 Riviera Maya, MEX

Tatami

Pool

1/1

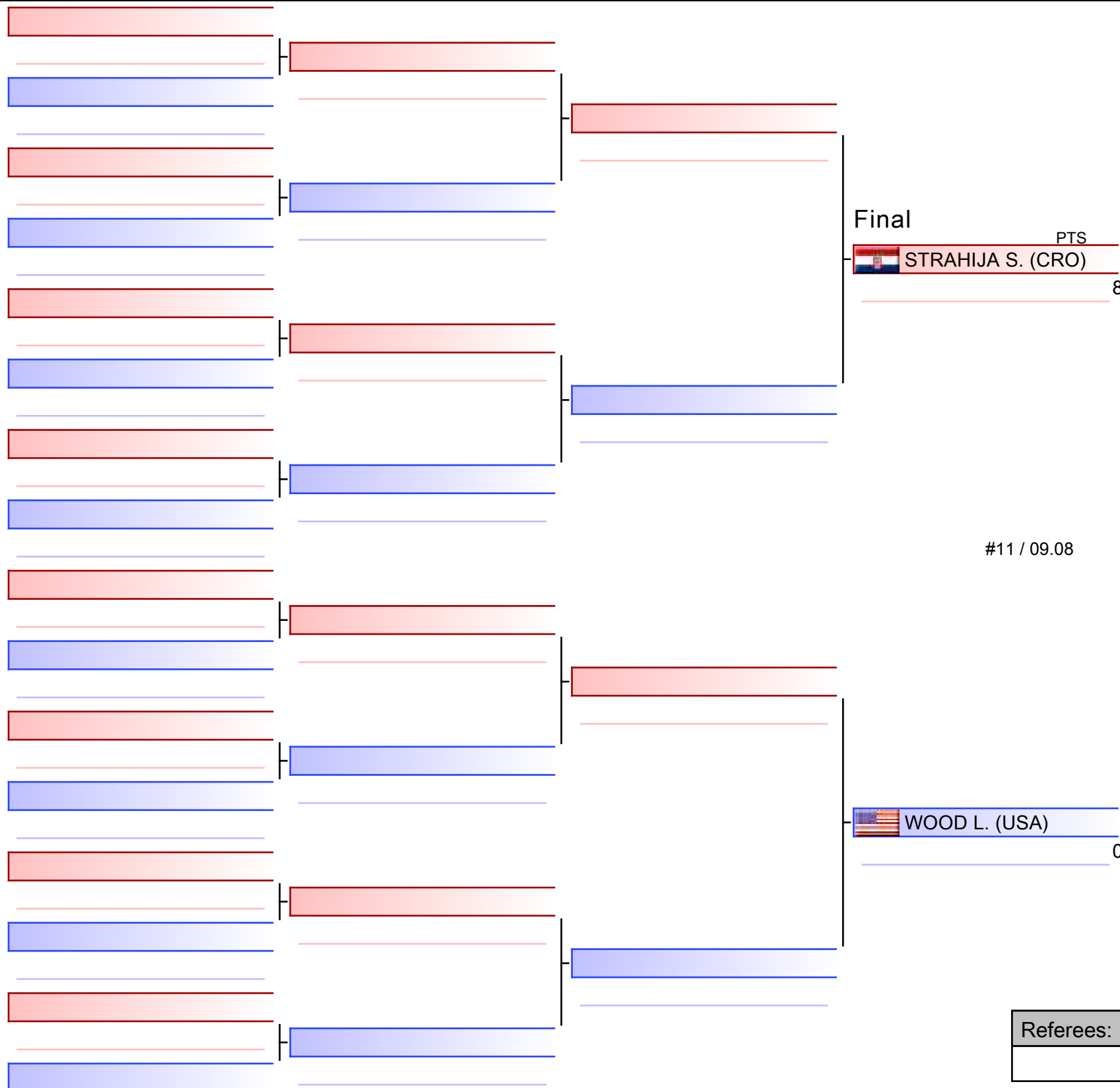

Final

PTS

STRAHIJA S. (CRO)

8

#11 / 09.08

STRAHIJA S. (CRO)

WOOD L. (USA)

0

- | |
|---|
| 1. STRAHIJA SVEN (CRO) |
| 2. WOOD LANDEN (USA) |
| 3. LEAL MORENO IKER (ESP) |
| 3. PEÑA RENATO (CHI) |
| 5. ZUNIGA SPÄTHE ROBIN MATEO (GER) |
| 5. SANDOVAL SANDOVAL JOSE ANTONIO (MEX) |
| 7. MORALES SERRANO GERSHON ADIR (GUA) |
| 7. ORTEGA DESCIDERIO ANGEL JOSUE (MEX) |

Referees:			

Junior Kumite Male -76 kg

Karate1 Youth League - Cancun 2024

2024-08-09

Tatami
1 14:45

Pool
1

(c)sportdata GmbH & Co KG 2000-2024 (2024-08-11 14:42) v 10.2.0 build 1 (2024-08-09 20:34 CET) License: Online_Event_ID-875_Karate1YouthLeagueCancun2024 (expire 2024-08-25)

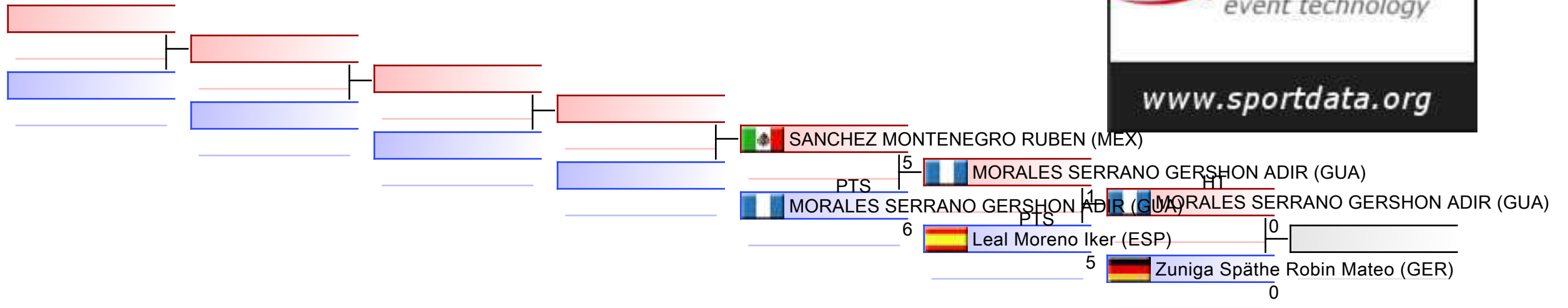

REPECHAGE: (1)

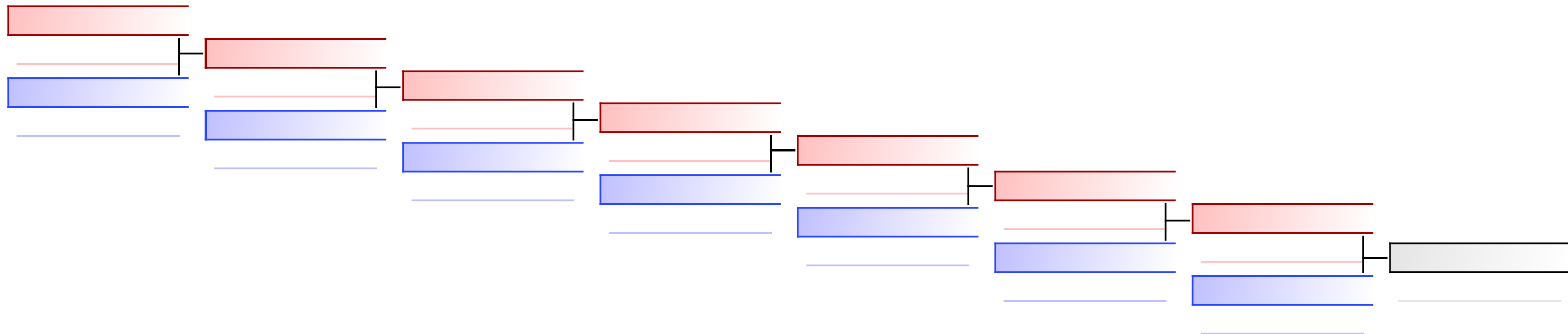

Referees:							
-----------	--	--	--	--	--	--	--

Junior Kumite Male -76 kg

Karate1 Youth League - Cancun 2024

2024-08-09

Tatami

1 14:45

Pool

1,2

(c)sportdata GmbH & Co KG 2000-2024 (2024-08-11 14:42) v 10.2.0 build 1 (2024-08-09 20:34 CET) License: Online_Event_ID-875_Karate1YouthLeagueCancun2024 (expire 2024-08-25)

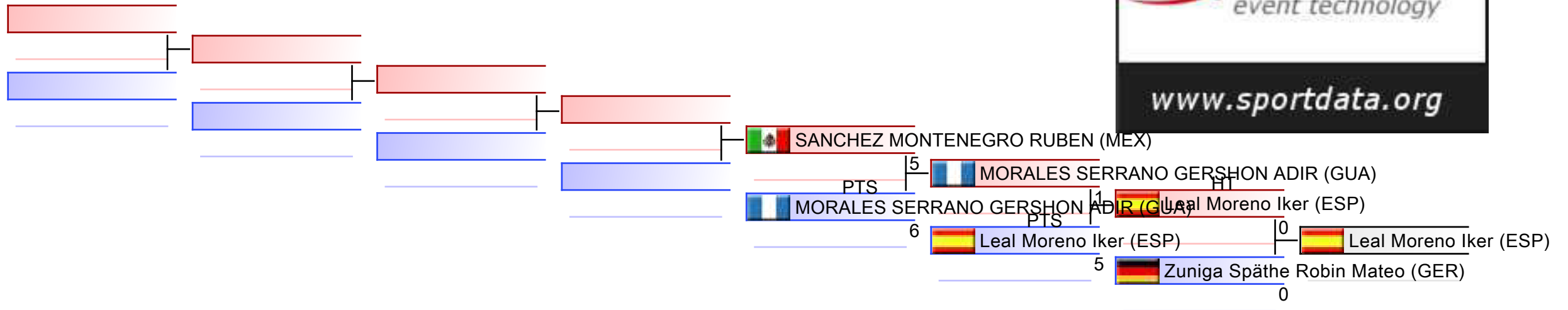

REPECHAGE: (1,2)

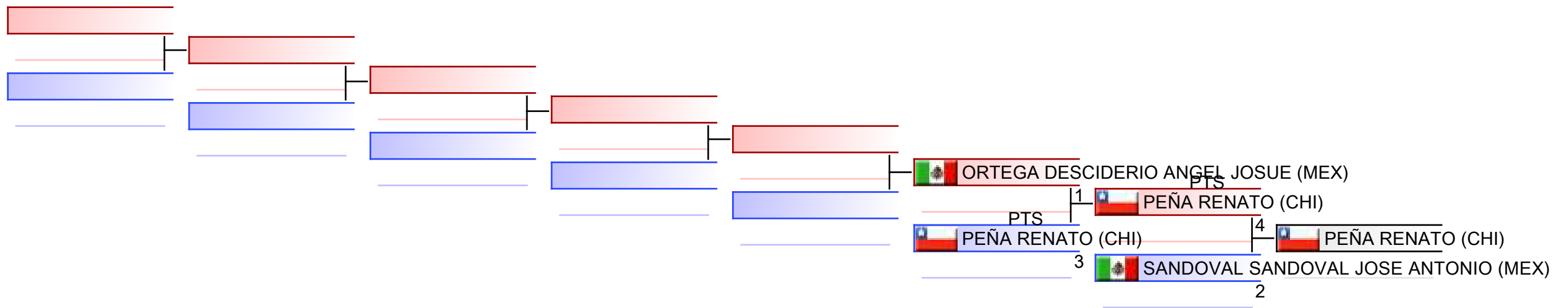

Referees:							
-----------	--	--	--	--	--	--	--



Karate1 Youth League - Cancun 2024 - 2024-08-08



Official Results

Junior Kumite Male -76 kg			
1	STRAHIJA SVEN		CRO - CROATIA
2	WOOD LANDEN		USA - UNITED STATES
3	LEAL MORENO IKER		ESP - SPAIN
3	PEÑA RENATO		CHI - CHILE
5	ZUNIGA SPÄTHE ROBIN MATEO		GER - GERMANY
5	SANDOVAL SANDOVAL JOSE ANTONIO		MEX - MEXICO
7	MORALES SERRANO GERSHON ADIR		GUA - GUATEMALA
7	ORTEGA DESCIDERIO ANGEL JOSUE		MEX - MEXICO
9	SANCHEZ MONTENEGRO RUBEN		MEX - MEXICO

JUNIOR KUMITE MALE 76+ KG



Karate1 Youth League - Cancun 2024
ENTRIES BY WEIGHT CATEGORY



Junior Kumite Male 76+ kg
As of 11 AUG 2024

NOC Code	Gender	Name	Seeding
AUT	M	SELIMOVIC ARMIN	
CHI	M	Gálvez Tamayo Vicente Cristóbal	
CRC	M	CARDENAS EDUARDO	
CRO	M	GONDI NIKOLA	
ESP	M	MIRESAN SECHEI CRISTIAN ALEXANDRU	
ESP	M	Ruiz Ruiz José Luis	
HON	M	Torres Santos Henry Samael	
MEX	M	GARZA CHAVARRIA FRANCISCO DEMIAN	
MEX	M	MORENO CANO JOSE DE JESUS	
MEX	M	MORENO FLORES GUILLERMO ZABDIEL	
MEX	M	PUEBLA GODOY GABRIEL TZAM	
MEX	M	RODRIGUEZ PEREZ JAVIER ALEJANDRO	
MEX	M	SANTIAGO ZAVALA LUIS EDUARDO	
PAR	M	SANCHEZ CAMILO	
USA	M	Molinero Michael	

Junior Kumite Male 76+ kg

Karate1 Youth League - Cancun 2024, Iberostar Playa Paraíso Convention Center, Avenida del Sol Km 309, Playa Paraiso, 77710 Riviera Maya, MEX

2024-08-09

Tatami
2 12:45

Pool
1/2

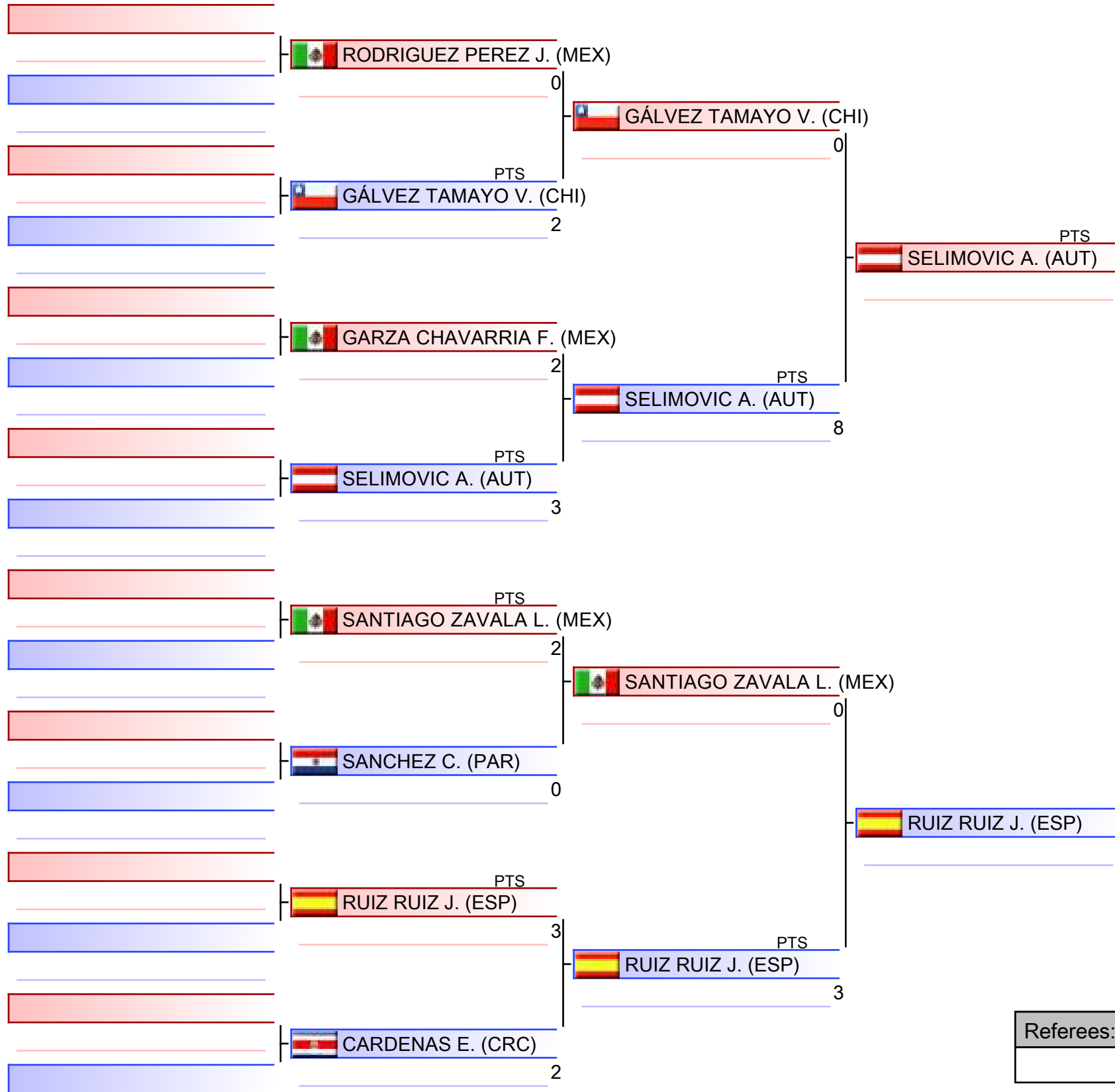

1. GONDI NIKOLA (CRO)
2. SELIMOVIC ARMIN (AUT)
3. MOLINERO MICHAEL (USA)
3. RUIZ RUIZ JOSÉ LUIS (ESP)
5. MIRESAN SECHEI CRISTIAN ALEXANDRU (ESP)
5. GARZA CHAVARRIA FRANCISCO DEMIAN (MEX)
7. MORENO FLORES GUILLERMO ZABDIEL (MEX)
7. GÁLVEZ TAMAYO VICENTE CRISTÓBAL (CHI)

Referees:			

Junior Kumite Male 76+ kg

Karate1 Youth League - Cancun 2024, Iberostar Playa Paraíso Convention Center, Avenida del Sol Km 309, Playa Paraiso, 77710 Riviera Maya, MEX

2024-08-09

Tatami
2 13:20

Pool
2/2

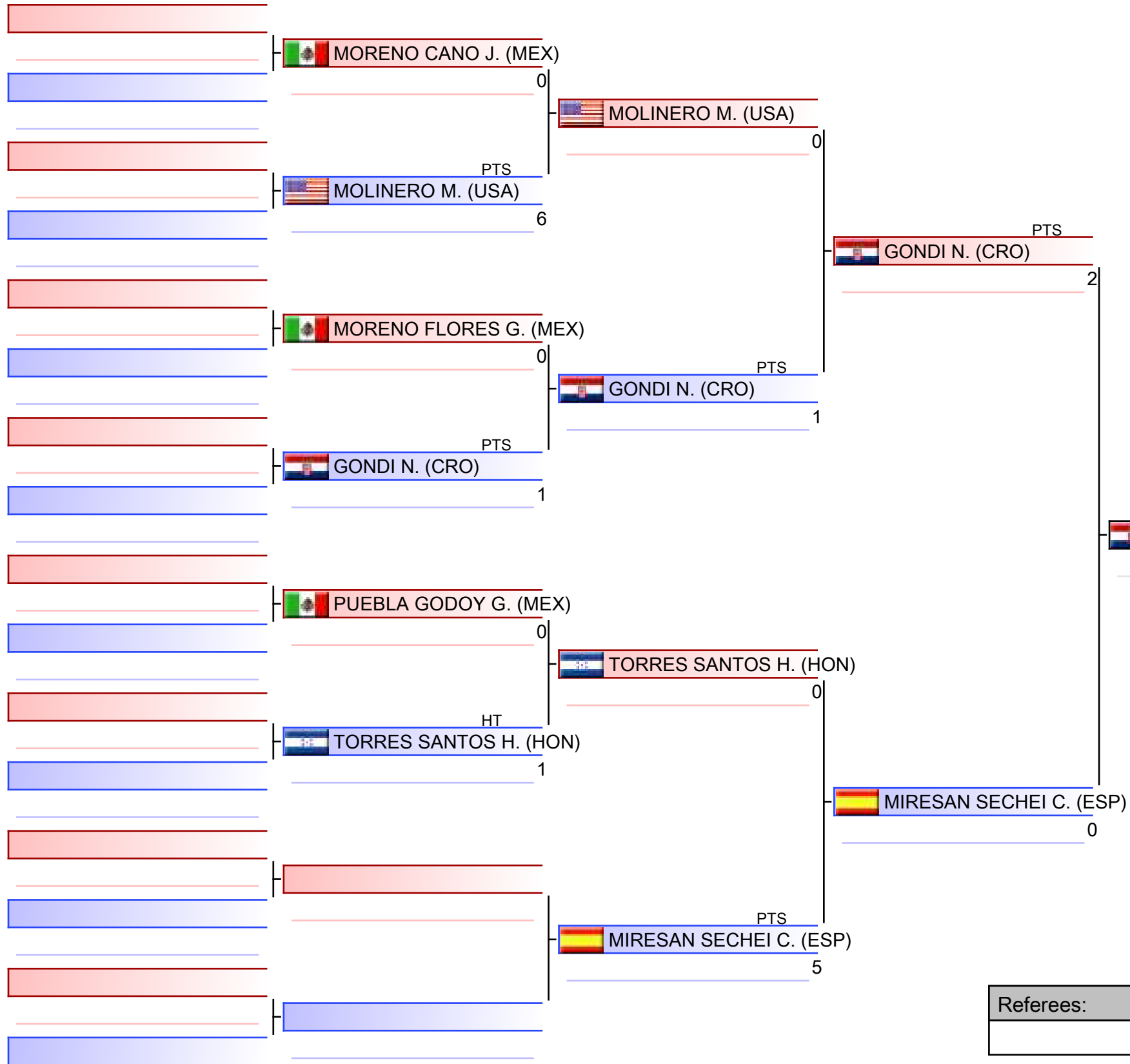

1. GONDI NIKOLA (CRO)
2. SELIMOVIC ARMIN (AUT)
3. MOLINERO MICHAEL (USA)
3. RUIZ RUIZ JOSÉ LUIS (ESP)
5. MIRESAN SECHEI CRISTIAN ALEXANDRU (ESP)
5. GARZA CHAVARRIA FRANCISCO DEMIAN (MEX)
7. MORENO FLORES GUILLERMO ZABDIEL (MEX)
7. GÁLVEZ TAMAYO VICENTE CRISTÓBAL (CHI)

Referees:			

Pool winner-Junior Kumite Male 76+ kg

Karate1 Youth League - Cancun 2024, Iberostar Playa Paraíso Convention Center, Avenida del Sol Km 309, Playa Paraiso, 77710 Riviera Maya, MEX

Tatami

Pool

1/1

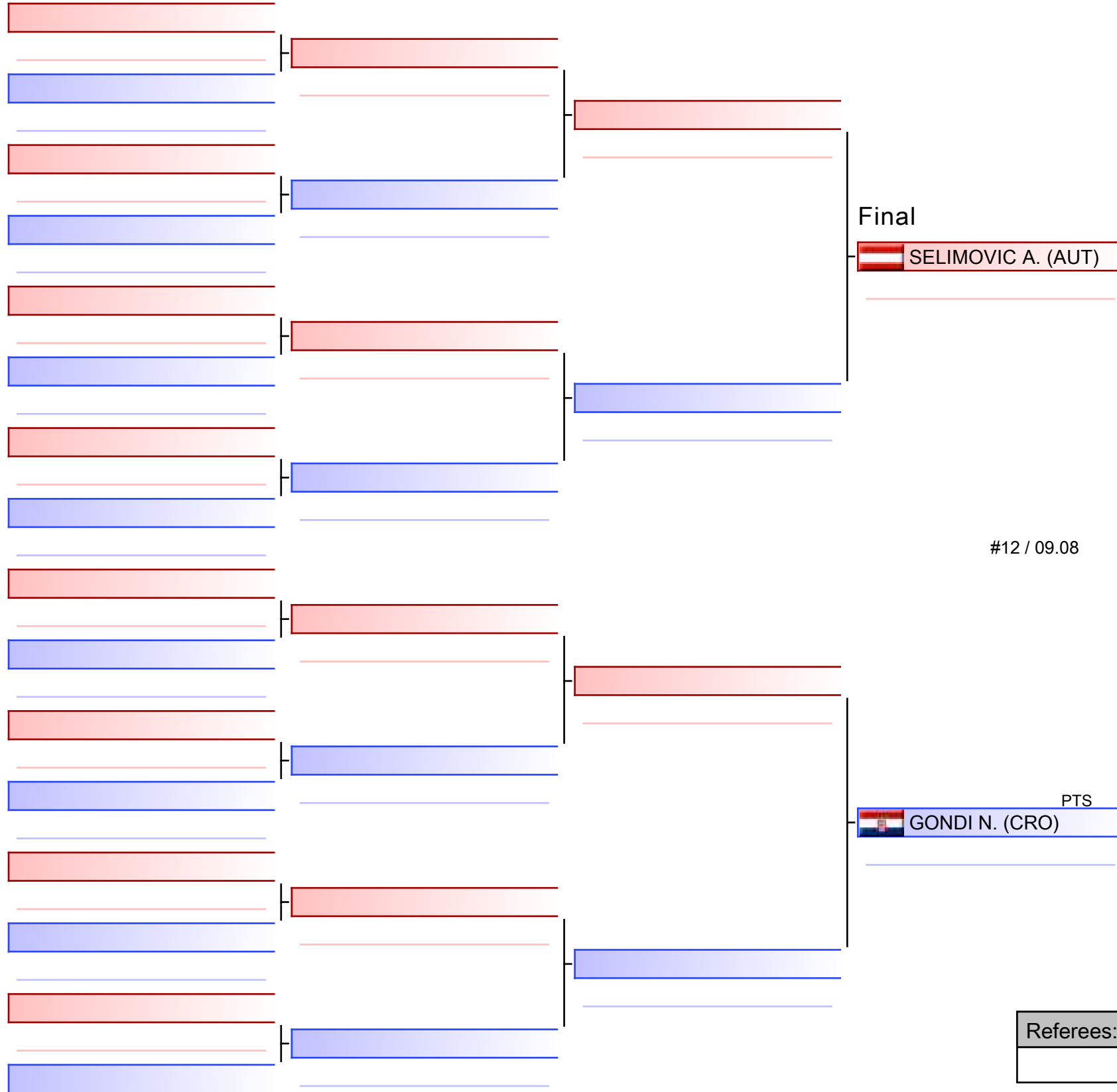

Final

SELIMOVIC A. (AUT)

0

#12 / 09.08

GONDI N. (CRO)

PTS

GONDI N. (CRO)

1

1. GONDI NIKOLA (CRO)
2. SELIMOVIC ARMIN (AUT)
3. MOLINERO MICHAEL (USA)
3. RUIZ RUIZ JOSÉ LUIS (ESP)
5. MIRESAN SECHEI CRISTIAN ALEXANDRU (ESP)
5. GARZA CHAVARRIA FRANCISCO DEMIAN (MEX)
7. MORENO FLORES GUILLERMO ZABDIEL (MEX)
7. GÁLVEZ TAMAYO VICENTE CRISTÓBAL (CHI)

Referees:			

Junior Kumite Male 76+ kg

Karate1 Youth League - Cancun 2024

2024-08-09

Tatami

2 13:50

Pool

1,2

(c)sportdata GmbH & Co KG 2000-2024 (2024-08-11 14:42) v 10.2.0 build 1 (2024-08-09 20:34 CET) License: Online_Event_ID-875_Karate1YouthLeagueCancun2024 (expire 2024-08-25)

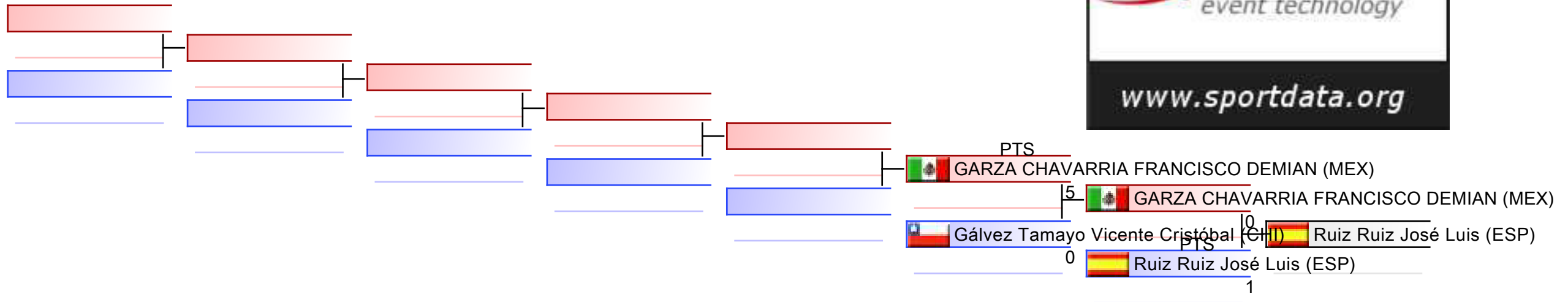

REPECHAGE: (1,2)

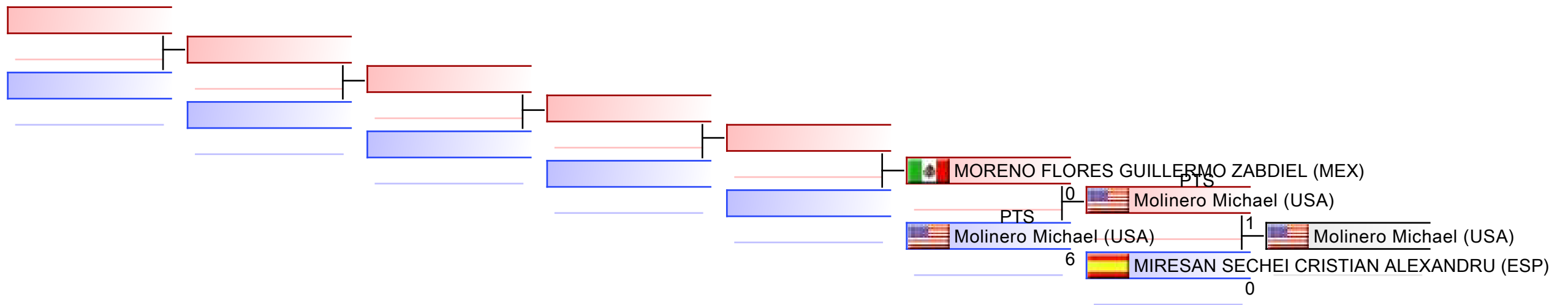

Referees:							
-----------	--	--	--	--	--	--	--



Karate1 Youth League - Cancun 2024 - 2024-08-08



Official Results

Junior Kumite Male 76+ kg			
1	GONDI NIKOLA		CRO - CROATIA
2	SELIMOVIC ARMIN		AUT - AUSTRIA
3	MOLINERO MICHAEL		USA - UNITED STATES
3	RUIZ RUIZ JOSÉ LUIS		ESP - SPAIN
5	MIRESAN SECHEI CRISTIAN ALEXANDRU		ESP - SPAIN
5	GARZA CHAVARRIA FRANCISCO DEMIAN		MEX - MEXICO
7	MORENO FLORES GUILLERMO ZABDIEL		MEX - MEXICO
7	GÁLVEZ TAMAYO VICENTE CRISTÓBAL		CHI - CHILE

U14 KATA FEMALE



Karate1 Youth League - Cancun 2024
ENTRIES BY WEIGHT CATEGORY



U14 Kata Female
As of 11 AUG 2024

NOC Code	Gender	Name	Seeding
AUS	F	WIBOWO REBECCA	
CRC	F	SOLOMON ALANA	
MEX	F	GARCIA ARELLANO NAOMI ALOTL	
MEX	F	GARZA VIZCAINO MARIA VICTORIA	
MEX	F	HERNANDEZ QUIROZ ROBERTA	
MEX	F	PATRICIO GAYOSSO REGINA	
MEX	F	Perez Gonzalez Nahomi Dayana	
SUI	F	Schedel Kaena	
USA	F	Andreevski Kalina	
USA	F	Nguyen Katelyn	
USA	F	Rashidi Lily	
USA	F	Shahnaz Lajwerd	

U14 Kata Female

Karate1 Youth League - Cancun 2024, Iberostar Playa Paraíso Convention Center, Avenida del Sol Km 309, Playa Paraiso, 77710 Riviera Maya, MEX

2024-08-11

Tatami

3 09:00

Pool

1/2

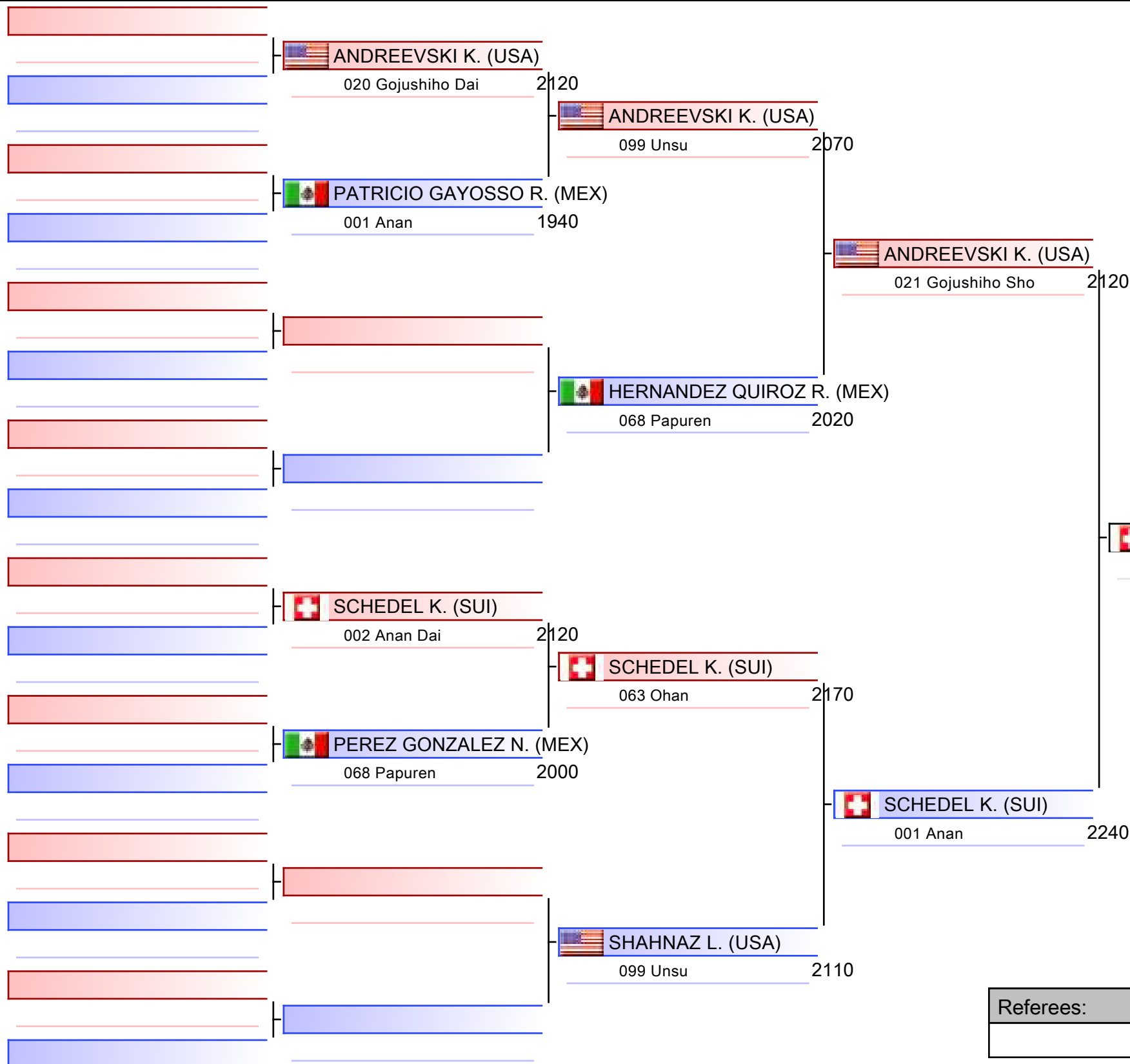

1. NGUYEN KATELYN (USA)
2. SCHEDEL KAENA (SUI)
3. RASHIDI LILY (USA)
3. ANDREEVSKI KALINA (USA)
5. SOLOMON ALANA (CRC)
5. SHAHNAZ LAJWERD (USA)
7. GARZA VIZCAINO MARIA VICTORIA (MEX)
7. PEREZ GONZALEZ NAHOMI DAYANA (MEX)

Referees:			

U14 Kata Female

Karate1 Youth League - Cancun 2024, Iberostar Playa Paraíso Convention Center, Avenida del Sol Km 309, Playa Paraiso, 77710 Riviera Maya, MEX

2024-08-11

Tatami

4 09:00

Pool

2/2

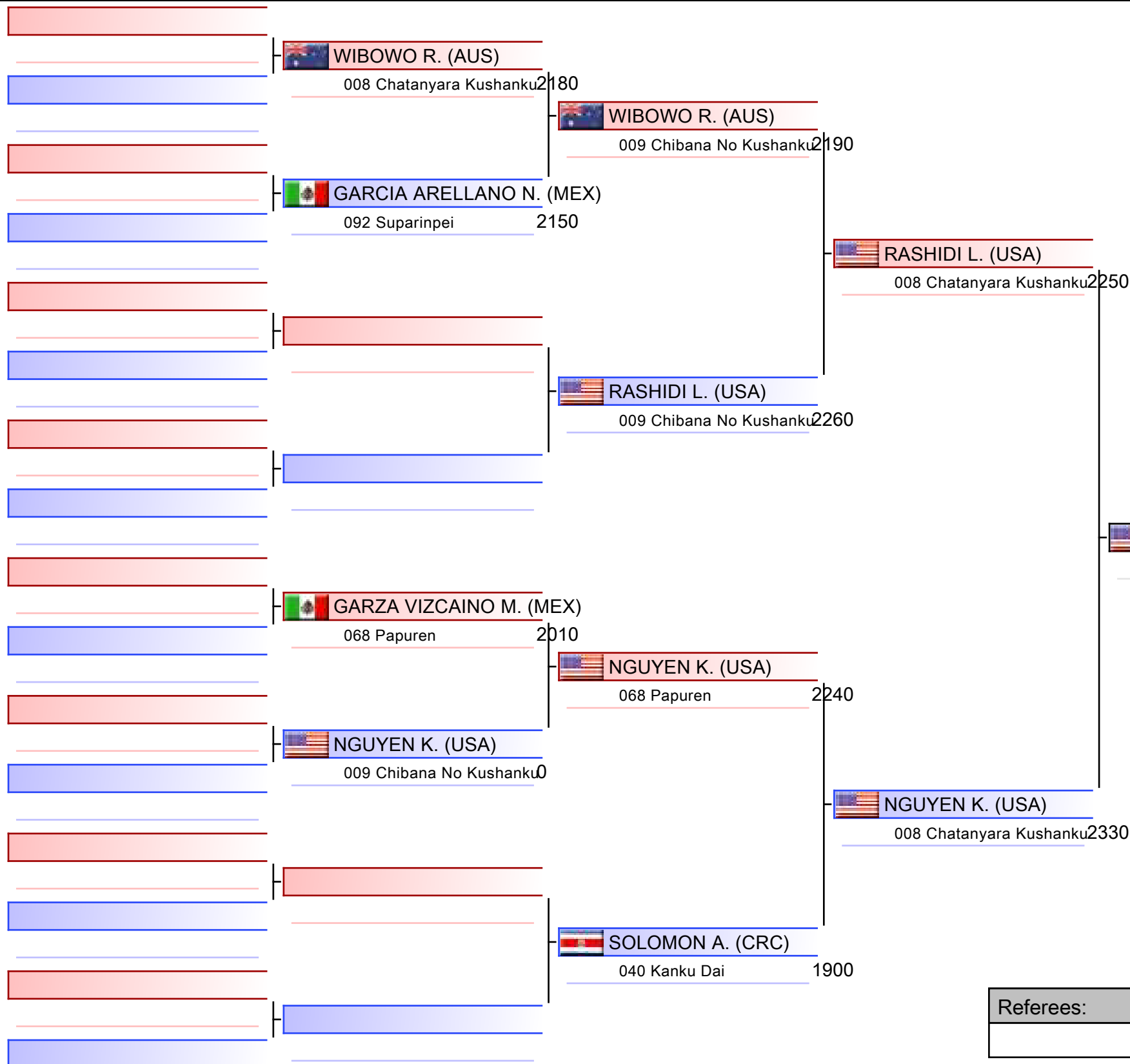

1. NGUYEN KATELYN (USA)
2. SCHEDEL KAENA (SUI)
3. RASHIDI LILY (USA)
3. ANDREEVSKI KALINA (USA)
5. SOLOMON ALANA (CRC)
5. SHAHNAZ LAJWERD (USA)
7. GARZA VIZCAINO MARIA VICTORIA (MEX)
7. PEREZ GONZALEZ NAHOMI DAYANA (MEX)

Referees:			

Pool winner-U14 Kata Female

Karate1 Youth League - Cancun 2024, Iberostar Playa Paraíso Convention Center, Avenida del Sol Km 309, Playa Paraiso, 77710 Riviera Maya, MEX

Tatami

Pool

1/1

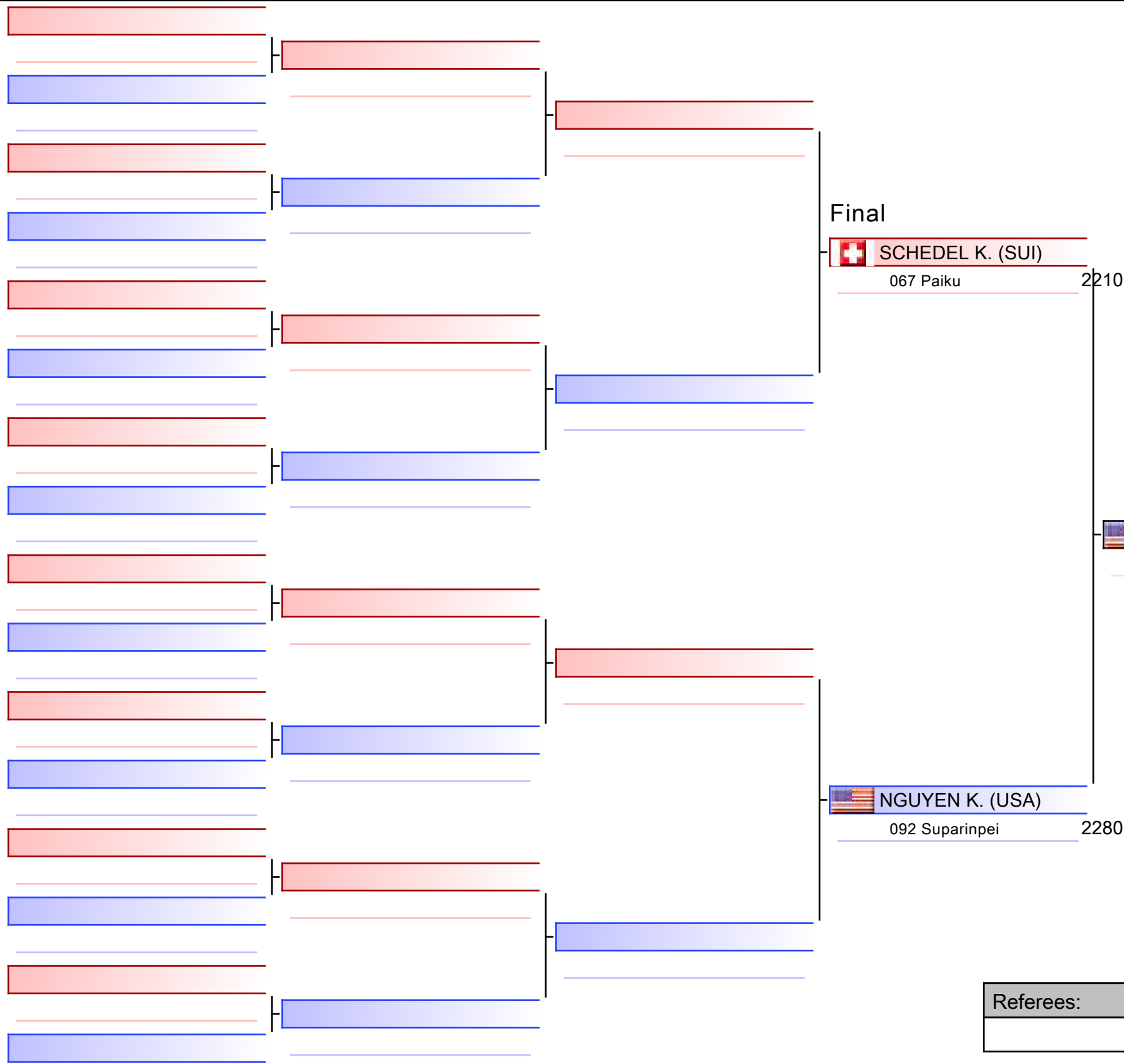

- | |
|--|
| 1. NGUYEN KATELYN (USA) |
| 2. SCHEDEL KAENA (SUI) |
| 3. RASHIDI LILY (USA) |
| 3. ANDREEVSKI KALINA (USA) |
| 5. SOLOMON ALANA (CRC) |
| 5. SHAHNAZ LAJWERD (USA) |
| 7. GARZA VIZCAINO MARIA VICTORIA (MEX) |
| 7. PEREZ GONZALEZ NAHOMI DAYANA (MEX) |

Referees:			

U14 Kata Female

Karate1 Youth League - Cancun 2024

2024-08-11

Tatami
3 09:40

Pool
1

(c)sportdata GmbH & Co KG 2000-2024 (2024-08-11 14:42) v 10.2.0 build 1 (2024-08-09 20:34 CET) License: Online_Event_ID-875_Karate1YouthLeagueCancun2024 (expire 2024-08-25)

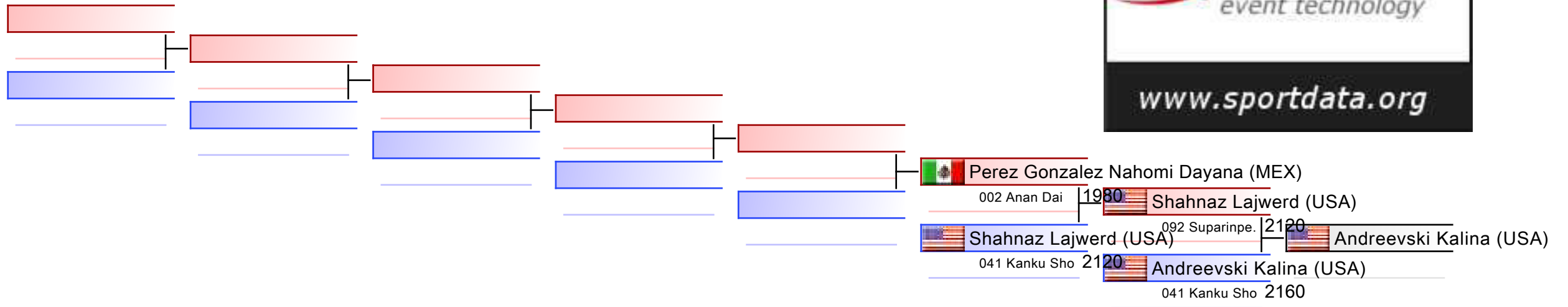

REPECHAGE: (1)

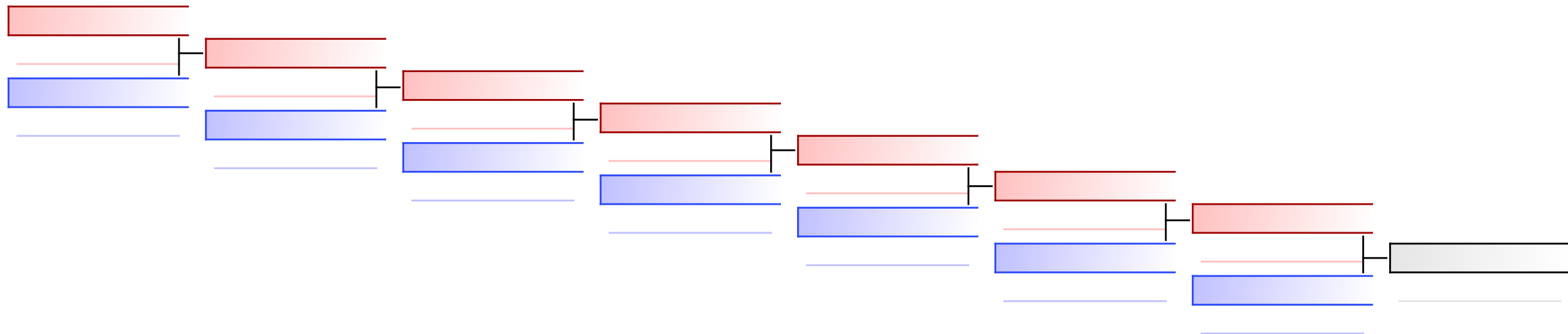

Referees:							
-----------	--	--	--	--	--	--	--

U14 Kata Female

Karate1 Youth League - Cancun 2024

2024-08-11

Tatami
4 09:40

Pool
2

(c)sportdata GmbH & Co KG 2000-2024 (2024-08-11 14:42) v 10.2.0 build 1 (2024-08-09 20:34 CET) License: Online_Event_ID-875_Karate1YouthLeagueCancun2024 (expire 2024-08-25)

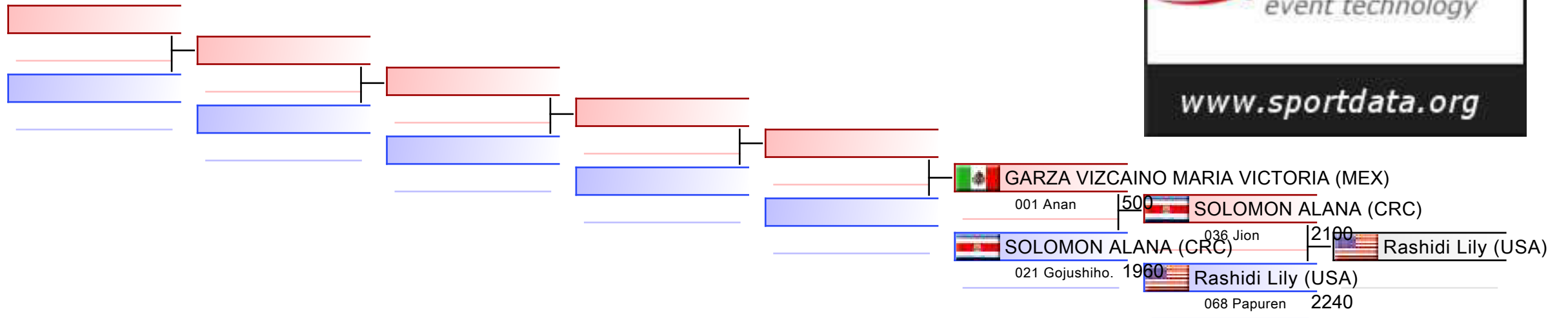

REPECHAGE: (2)

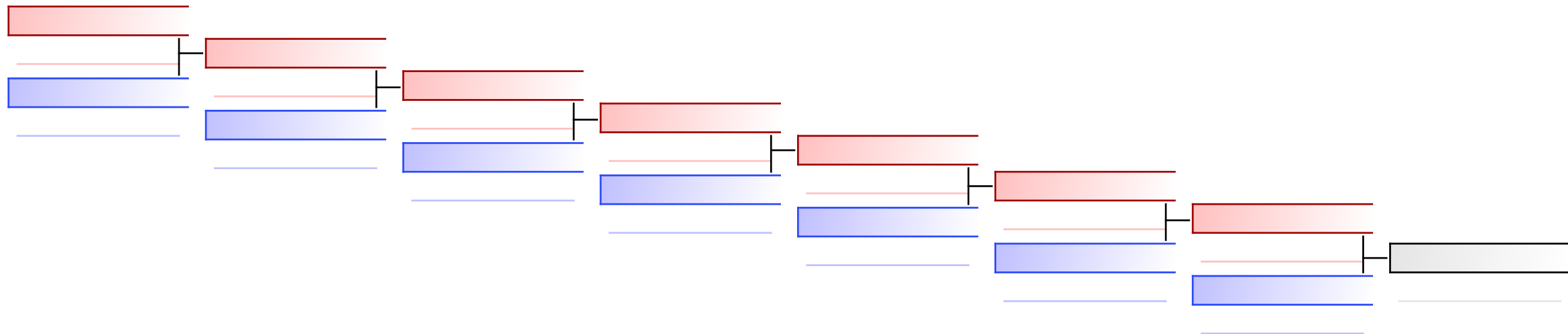

Referees:							
-----------	--	--	--	--	--	--	--



Karate1 Youth League - Cancun 2024 - 2024-08-08



Official Results

U14 Kata Female			
1	NGUYEN KATELYN		USA - UNITED STATES
2	SCHEDL KAENA		SUI - SWITZERLAND
3	RASHIDI LILY		USA - UNITED STATES
3	ANDREEVSKI KALINA		USA - UNITED STATES
5	SOLOMON ALANA		CRC - COSTA RICA
5	SHAHAZ LAJWERD		USA - UNITED STATES
7	GARZA VIZCAINO MARIA VICTORIA		MEX - MEXICO
7	PEREZ GONZALEZ NAHOMI DAYANA		MEX - MEXICO

U14 KATA MALE



Karate1 Youth League - Cancun 2024
ENTRIES BY WEIGHT CATEGORY



U14 Kata Male
As of 11 AUG 2024

NOC Code	Gender	Name	Seeding
AUT	M	ZADINA EMIL	
BRA	M	Miranda Vaz Murillo	
CAN	M	Concepcion Dean	
CAN	M	Gunja Karim	
CAN	M	HOBSON CHASE	
CHI	M	Sotomayor Villaroel Benjamin	
CRC	M	CORRALES NATAN	
CRC	M	GONZALES MOISES	
CRC	M	JIMENEZ NICOLAS	
DOM	M	CARBALLO JOSE	
DOM	M	DISLA JOSE	
DOM	M	SANCHEZ FIALLO JOSE GUILLERMO	
ESP	M	Castro López Braulio	
JAM	M	EVANS VALENTINO RASANDRE	
MEX	M	BAULCH LECA AIZEN	
MEX	M	BOJORQUEZ ARCE BRANDON VLADIMIR	
MEX	M	DELGADO SANCHEZ SAUL ALEJANDRO	
MEX	M	ROBLES CASTRO CARLOS KALEB	
MEX	M	SANTIAGO ZAVALA AXEL MANUEL	
SVK	M	VERCIMAK MARTIN	
USA	M	BARNABEI MASSIMO	
USA	M	Bonetti Akiau Luigi	
USA	M	Sanchez Luis	
USA	M	Sattanathan Sivanandh	
VEN	M	Muga Shamuel	

U14 Kata Male

Karate1 Youth League - Cancun 2024, Iberostar Playa Paraíso Convention Center, Avenida del Sol Km 309, Playa Paraiso, 77710 Riviera Maya, MEX

2024-08-11

Tatami

1 09:00

Pool

1/2

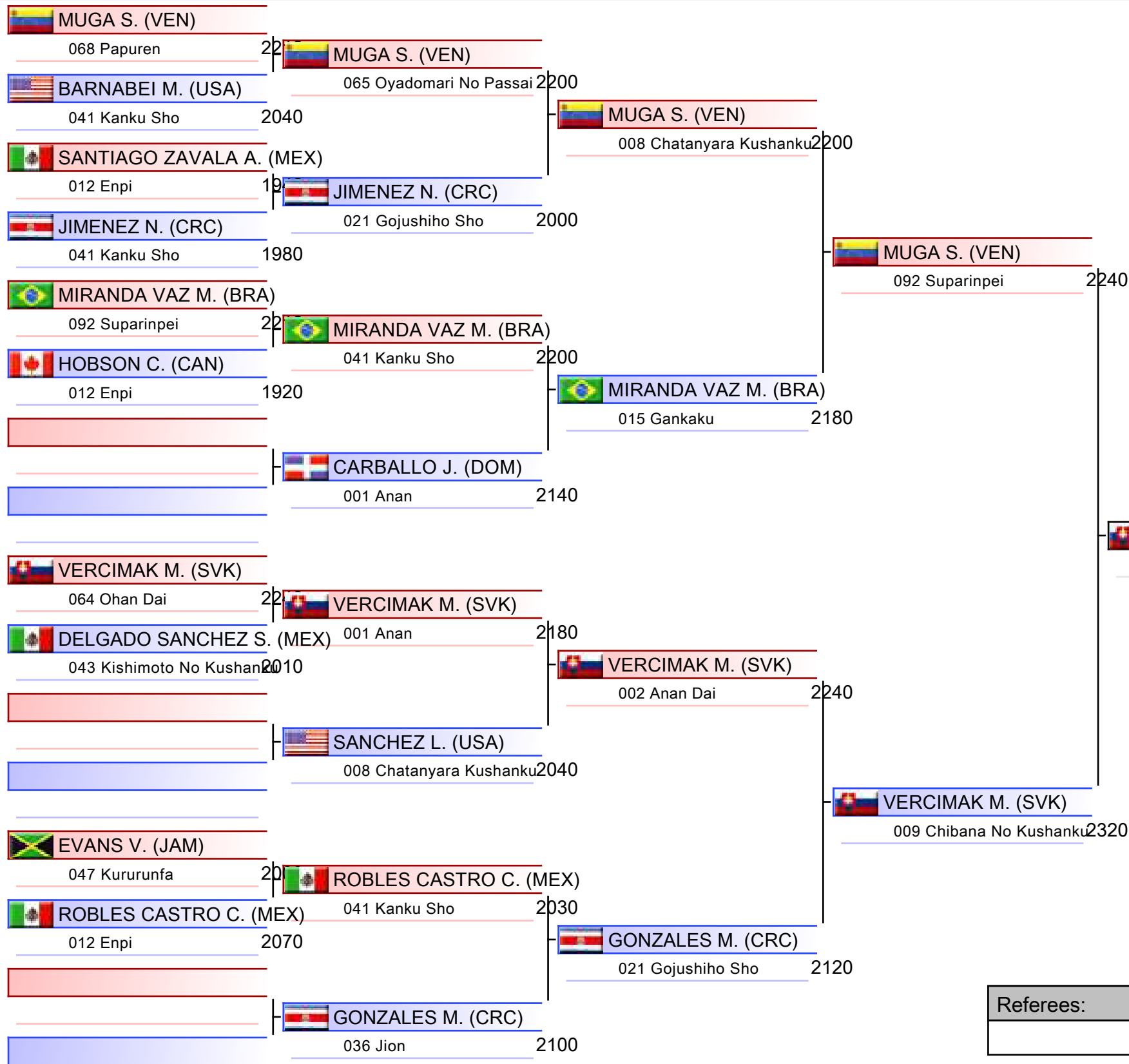

1. ZADINA EMIL (AUT)
2. VERCIMAK MARTIN (SVK)
3. CASTRO LÓPEZ BRAULIO (ESP)
3. MUGA SHAMUEL (VEN)
5. BONETTI AKIAU LUIGI (USA)
5. GONZALES MOISES (CRC)
7. GUNJA KARIM (CAN)
7. SANCHEZ LUIS (USA)

Referees:			

U14 Kata Male

Karate1 Youth League - Cancun 2024, Iberostar Playa Paraíso Convention Center, Avenida del Sol Km 309, Playa Paraiso, 77710 Riviera Maya, MEX

2024-08-11

Tatami

2 09:00

Pool

2/2

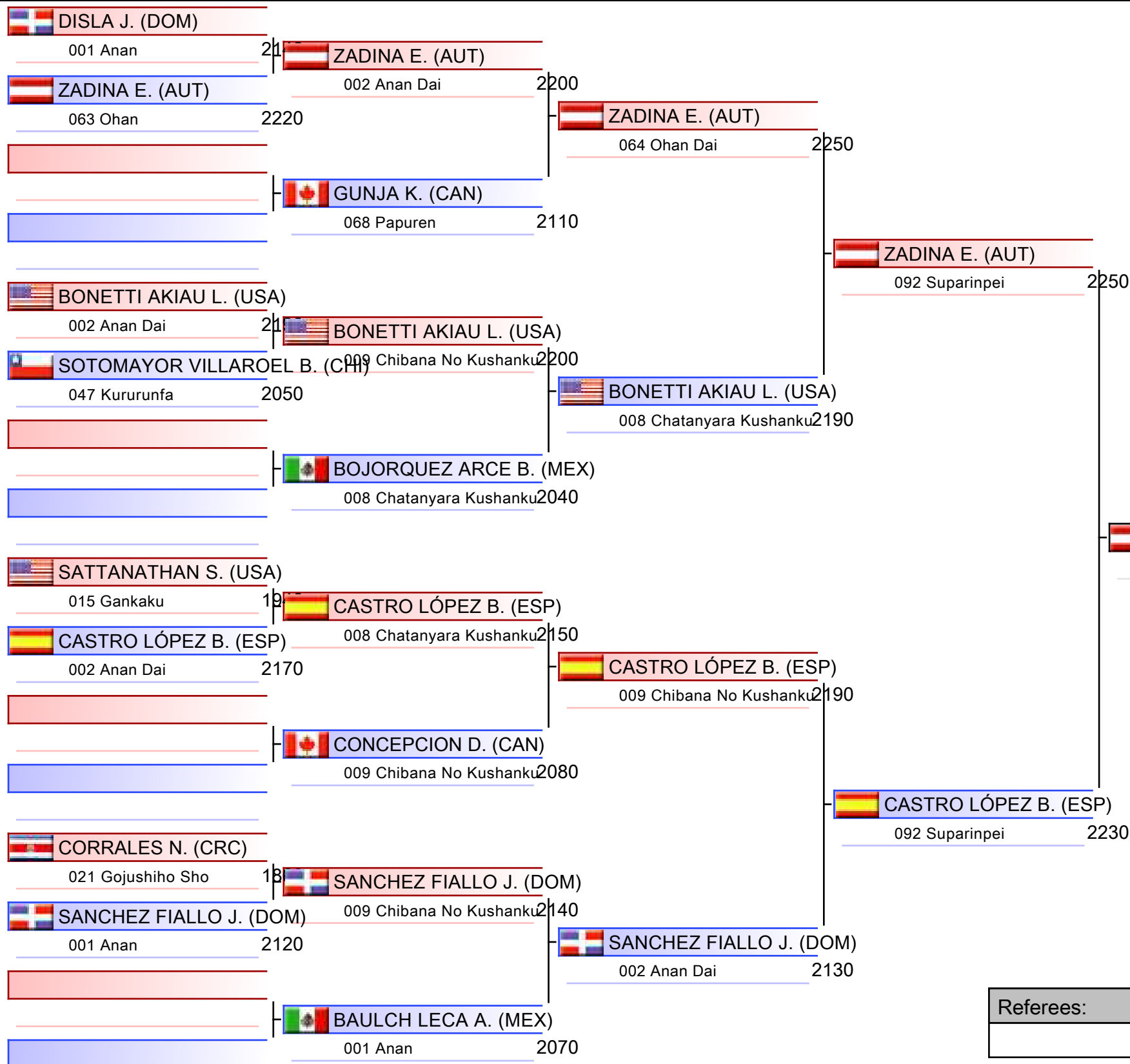

1. ZADINA EMIL (AUT)
2. VERCIMAK MARTIN (SVK)
3. CASTRO LÓPEZ BRAULIO (ESP)
3. MUGA SHAMUEL (VEN)
5. BONETTI AKIAU LUIGI (USA)
5. GONZALES MOISES (CRC)
7. GUNJA KARIM (CAN)
7. SANCHEZ LUIS (USA)

Referees:			

Pool winner-U14 Kata Male

Karate1 Youth League - Cancun 2024, Iberostar Playa Paraíso Convention Center, Avenida del Sol Km 309, Playa Paraiso, 77710 Riviera Maya, MEX

Tatami

Pool
1/1

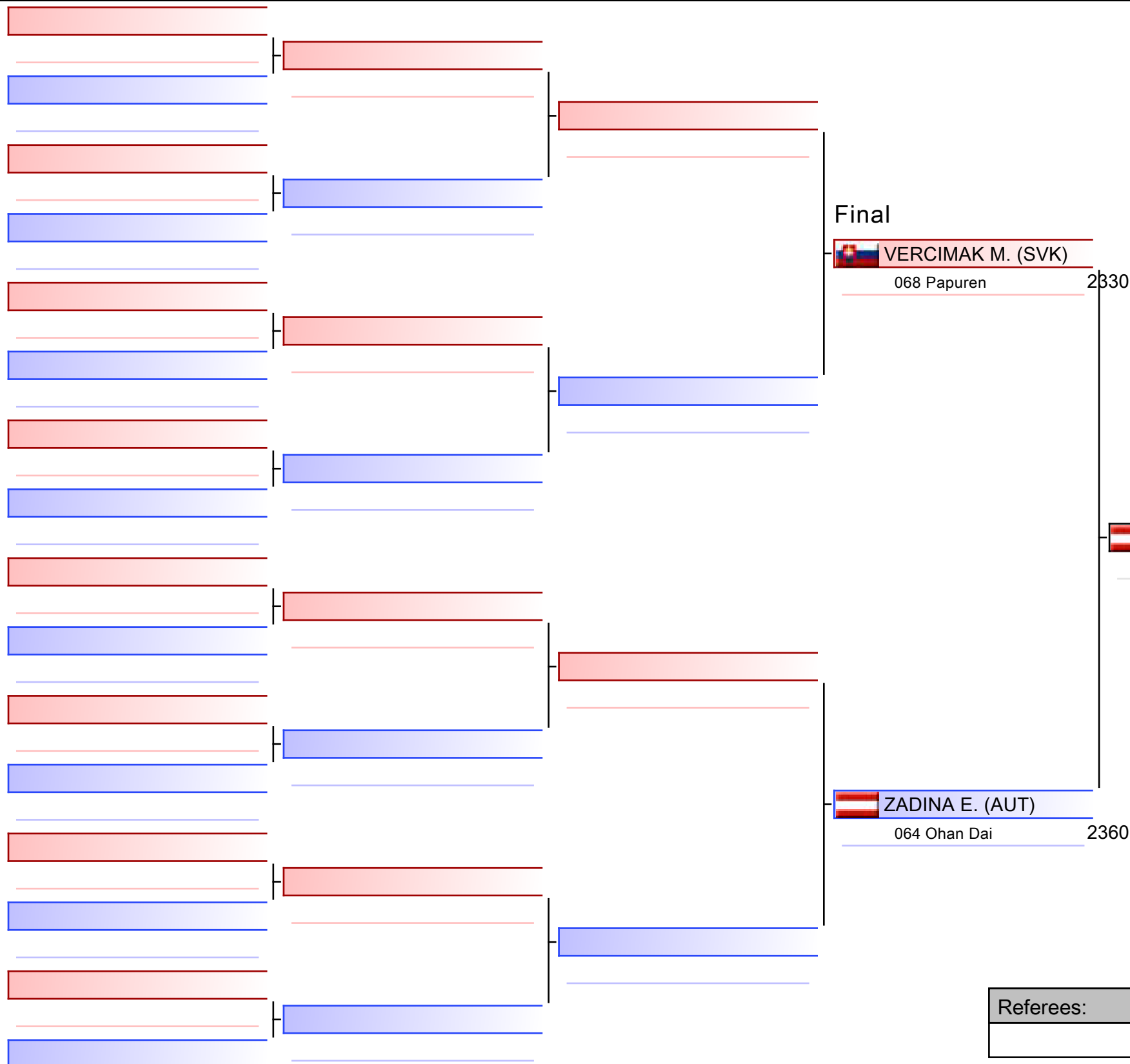

1. ZADINA EMIL (AUT)
2. VERCIMAK MARTIN (SVK)
3. CASTRO LÓPEZ BRAULIO (ESP)
3. MUGA SHAMUEL (VEN)
5. BONETTI AKIAU LUIGI (USA)
5. GONZALES MOISES (CRC)
7. GUNJA KARIM (CAN)
7. SANCHEZ LUIS (USA)

Referees:			

U14 Kata Male

Karate1 Youth League - Cancun 2024

2024-08-11

Tatami
1 10:35

Pool
1

(c)sportdata GmbH & Co KG 2000-2024 (2024-08-11 14:42) v 10.2.0 build 1 (2024-08-09 20:34 CET) License: Online_Event_ID-875_Karate1YouthLeagueCancun2024 (expire 2024-08-25)

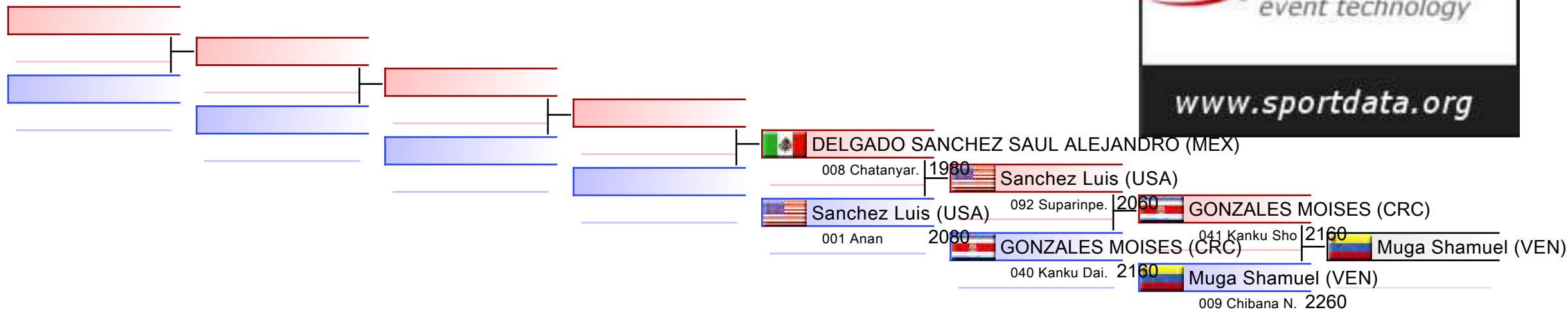

REPECHAGE: (1)

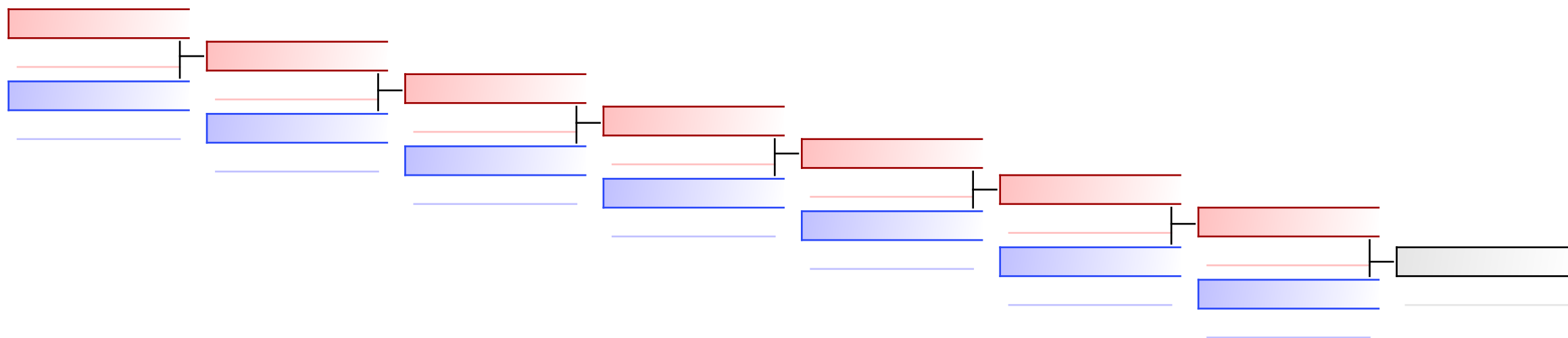

Referees:							
-----------	--	--	--	--	--	--	--

U14 Kata Male

Karate1 Youth League - Cancun 2024

2024-08-11

Tatami
2 10:30

Pool
2

(c)sportdata GmbH & Co KG 2000-2024 (2024-08-11 14:42) v 10.2.0 build 1 (2024-08-09 20:34 CET) License: Online_Event_ID-875_Karate1YouthLeagueCancun2024 (expire 2024-08-25)

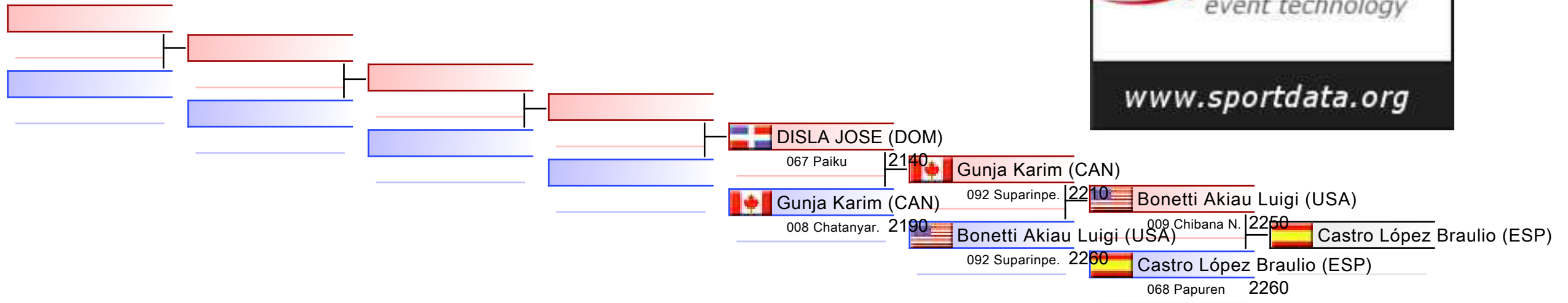

REPECHAGE: (2)

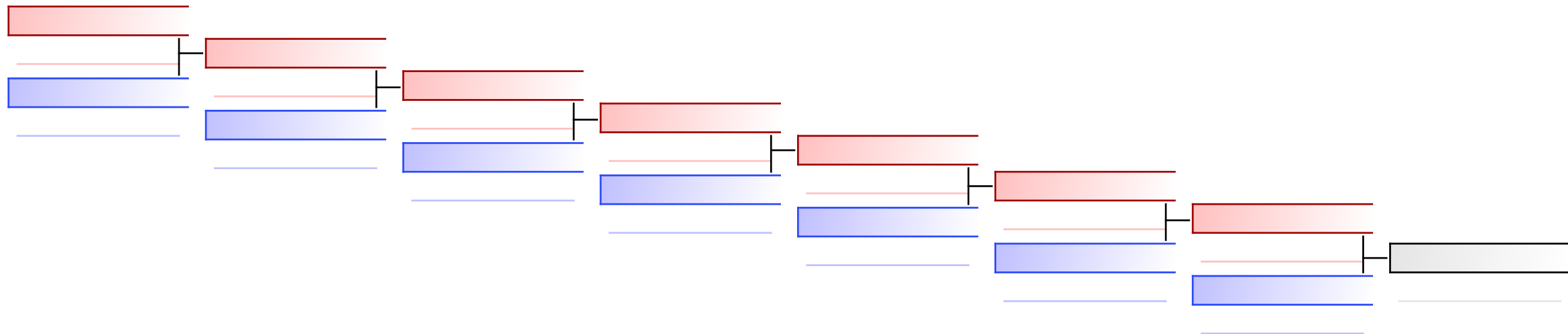

Referees:							
-----------	--	--	--	--	--	--	--



Karate1 Youth League - Cancun 2024 - 2024-08-08



Official Results

U14 Kata Male			
1	ZADINA EMIL		AUT - AUSTRIA
2	VERCIMAK MARTIN		SVK - SLOVAKIA
3	CASTRO LÓPEZ BRAULIO		ESP - SPAIN
3	MUGA SHAMUEL		VEN - VENEZUELA
5	BONETTI AKIAU LUIGI		USA - UNITED STATES
5	GONZALES MOISES		CRC - COSTA RICA
7	GUNJA KARIM		CAN - CANADA
7	SANCHEZ LUIS		USA - UNITED STATES
9	DISLA JOSE		DOM - DOMINICAN REPUBLIC
9	DELGADO SANCHEZ SAUL ALEJANDRO		MEX - MEXICO

U14 KUMITE FEMALE -42 KG



Karate1 Youth League - Cancun 2024
ENTRIES BY WEIGHT CATEGORY



U14 Kumite Female -42 kg
As of 11 AUG 2024

NOC Code	Gender	Name	Seeding
CAN	F	Gill Sereya	
CHI	F	Valderrama Alvarez Fernanda Amaral	
COL	F	PEREZ SALAMANCA NATALIA	
FRA	F	Ben Rabeh Aliya	
MEX	F	ALCAZAR CAMACHO Francés hannaely	
MEX	F	GARZA VIZCAINO MARIA VICTORIA	
USA	F	Andreevski Kalina	
USA	F	Shahnaz Lajwerd	

U14 Kumite Female -42 kg

Karate1 Youth League - Cancun 2024, Iberostar Playa Paraíso Convention Center, Avenida del Sol Km 309, Playa Paraiso, 77710 Riviera Maya, MEX

2024-08-11

Tatami

1 11:05

Pool

1/1

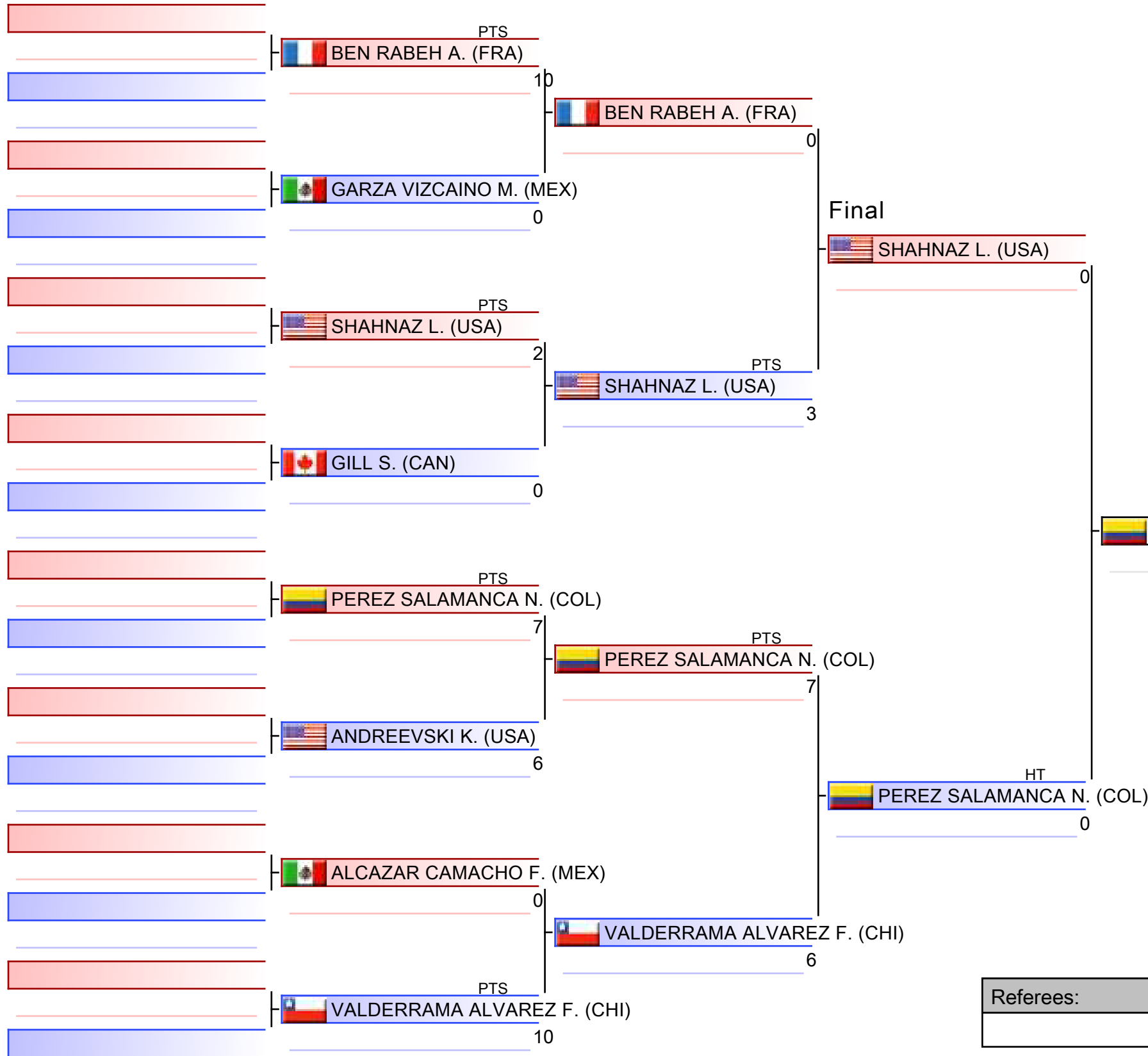

1. PEREZ SALAMANCA NATALIA (COL)
2. SHAHNAZ LAJWERD (USA)
3. VALDERRAMA ALVAREZ FERNANDA AMARAL
3. BEN RABEH ALIYA (FRA)
5. ANDREEVSKI KALINA (USA)
5. GILL SEREYA (CAN)

Referees:			

U14 Kumite Female -42 kg

Karate1 Youth League - Cancun 2024

2024-08-11

Tatami
1 11:30

Pool
1

(c)sportdata GmbH & Co KG 2000-2024 (2024-08-11 14:42) v 10.2.0 build 1 (2024-08-09 20:34 CET) License: Online_Event_ID-875_Karate1YouthLeagueCancun2024 (expire 2024-08-25)

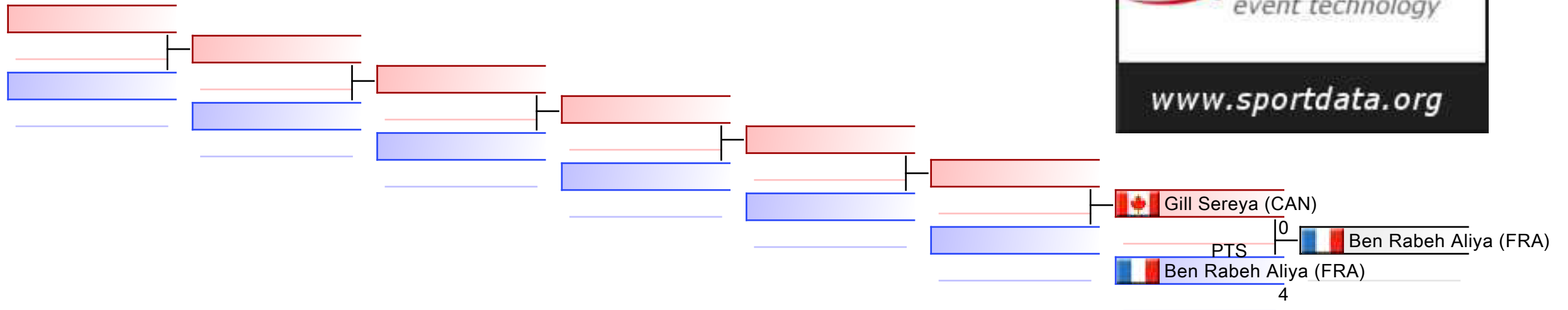

REPECHAGE: (1)

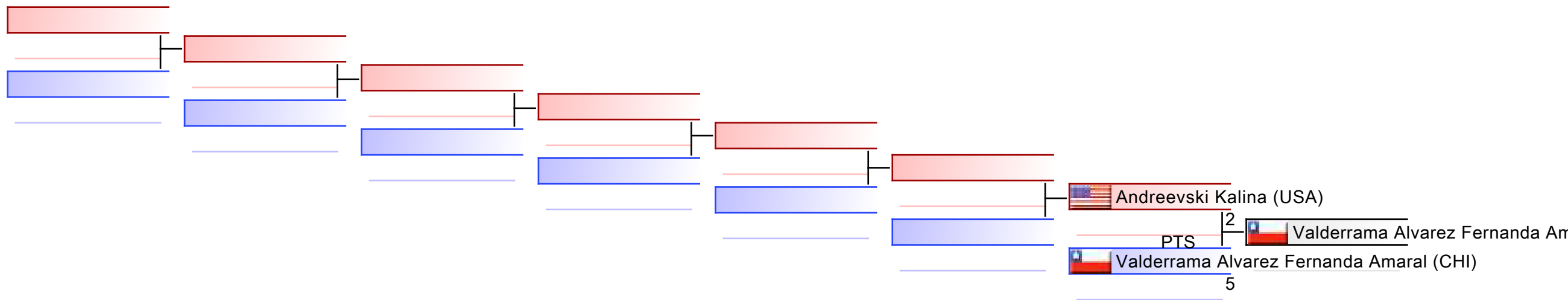

Referees:							
-----------	--	--	--	--	--	--	--



Karate1 Youth League - Cancun 2024 - 2024-08-08



Official Results

U14 Kumite Female -42 kg			
1	PEREZ SALAMANCA NATALIA		COL - COLOMBIA
2	SHAHNAZ LAJWERD		USA - UNITED STATES
3	VALDERRAMA ALVAREZ FERNANDA AMARAL		CHI - CHILE
3	BEN RABEH ALIYA		FRA - FRANCE
5	ANDREEVSKI KALINA		USA - UNITED STATES
5	GILL SEREYA		CAN - CANADA

U14 KUMITE FEMALE -47 KG



Karate1 Youth League - Cancun 2024
ENTRIES BY WEIGHT CATEGORY



U14 Kumite Female -47 kg
As of 11 AUG 2024

NOC Code	Gender	Name	Seeding
CAN	F	Jawkar Aarya	
CAN	F	RATHNAYAKE MUTHULI	
CHI	F	CAVICCHIOLI TOLEDO CONSTANZA	
CHI	F	Soto Catalina	
CRC	F	SOLOMON ALANA	
GER	F	Olschewski Hanna	
MEX	F	HERNANDEZ QUIROZ ROBERTA	
MLT	F	MADDEN LEIA-SUMMER	
PER	F	Vásquez Peña Astrid	
USA	F	Balint Elina	

U14 Kumite Female -47 kg

Karate1 Youth League - Cancun 2024, Iberostar Playa Paraíso Convention Center, Avenida del Sol Km 309, Playa Paraiso, 77710 Riviera Maya, MEX

2024-08-11

Tatami
1 11:40

Pool
1/1

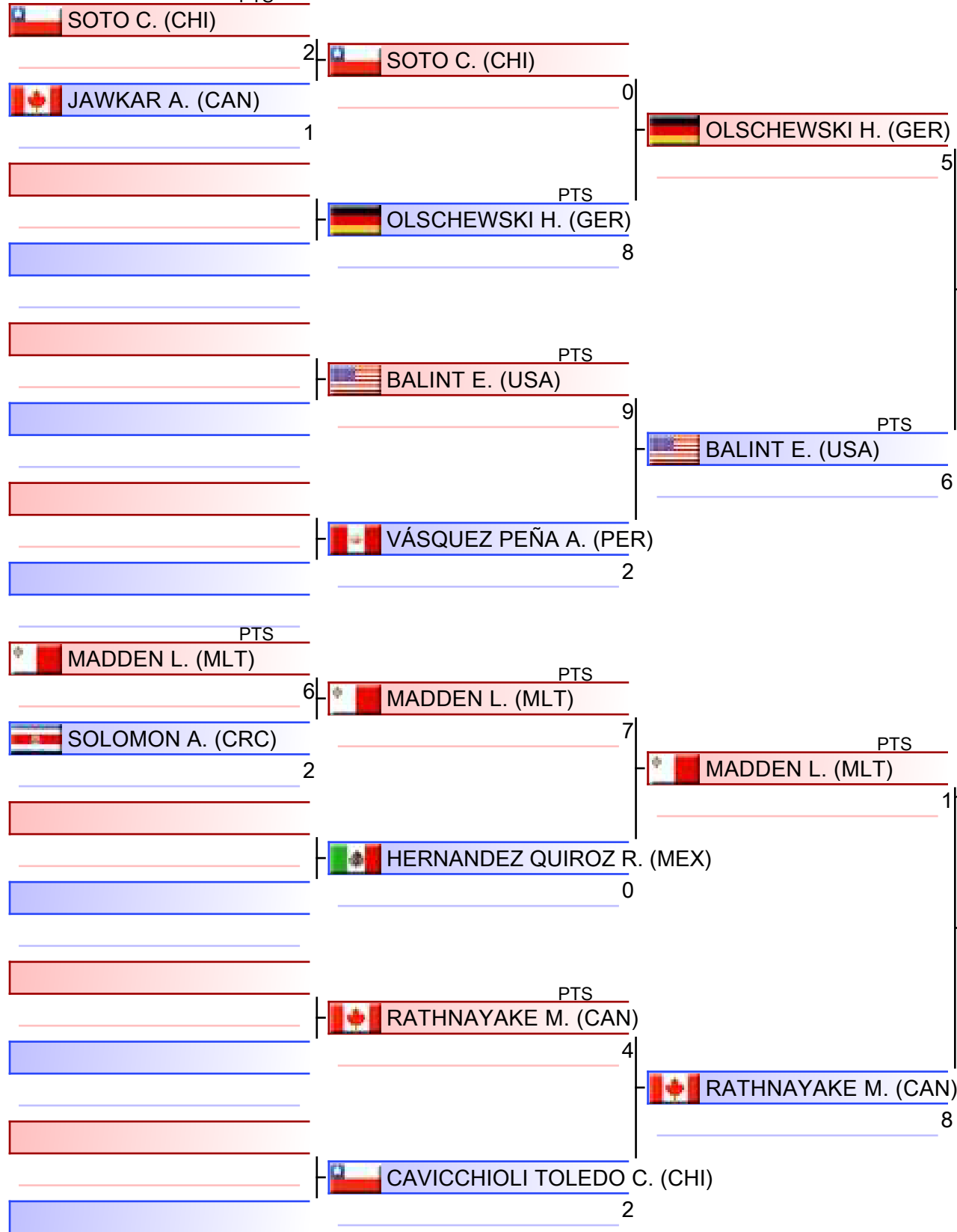

1. BALINT ELINA (USA)
2. MADDEN LEIA-SUMMER (MLT)
3. OLSCHESKI HANNA (GER)
3. RATHNAYAKE MUTHULI (CAN)
5. VÁSQUEZ PEÑA ASTRID (PER)
5. SOLOMON ALANA (CRC)
7. HERNANDEZ QUIROZ ROBERTA (MEX)

Referees:			

U14 Kumite Female -47 kg

Karate1 Youth League - Cancun 2024

2024-08-11

Tatami
1 12:15

Pool
1

(c)sportdata GmbH & Co KG 2000-2024 (2024-08-11 14:42) v 10.2.0 build 1 (2024-08-09 20:34 CET) License: Online_Event_ID-875_Karate1YouthLeagueCancun2024 (expire 2024-08-25)

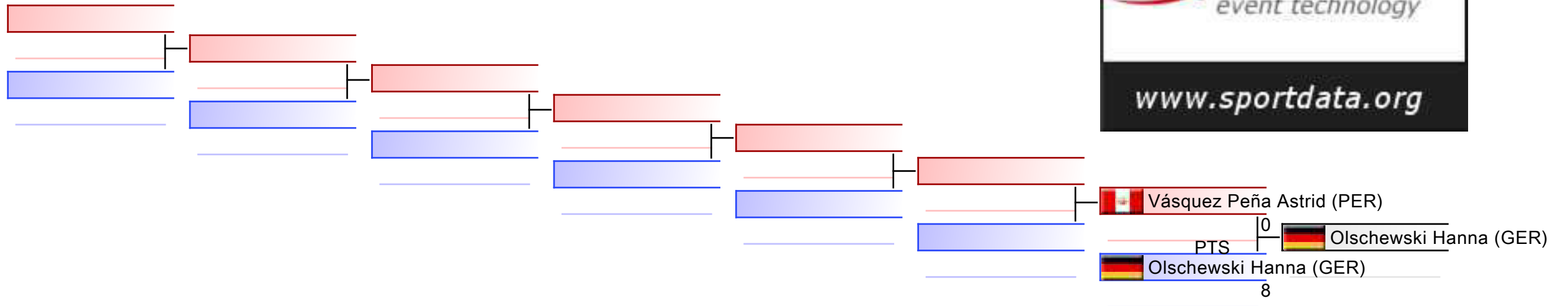

REPECHAGE: (1)

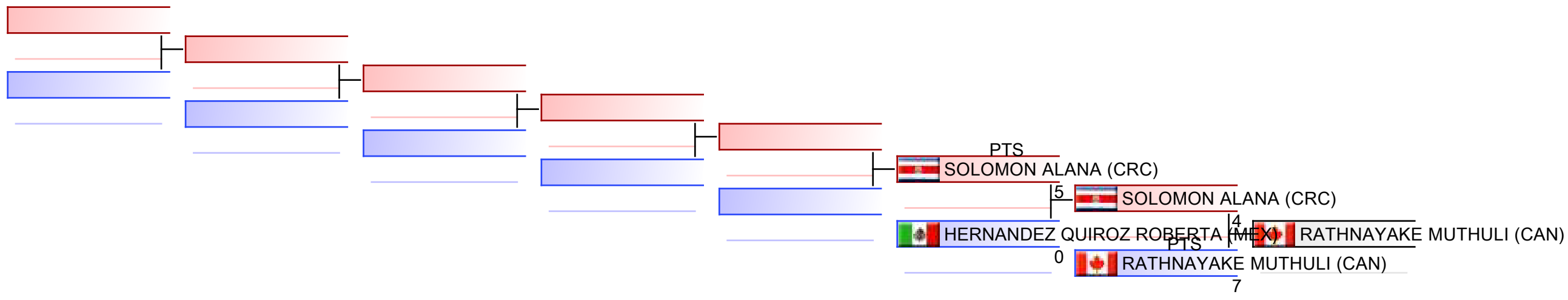

Referees:							
-----------	--	--	--	--	--	--	--



Karate1 Youth League - Cancun 2024 - 2024-08-08



Official Results

U14 Kumite Female -47 kg			
1	BALINT ELINA		USA - UNITED STATES
2	MADDEN LEIA-SUMMER		MLT - MALTA
3	OLSCHEWSKI HANNA		GER - GERMANY
3	RATHNAYAKE MUTHULI		CAN - CANADA
5	VÁSQUEZ PEÑA ASTRID		PER - PERU
5	SOLOMON ALANA		CRC - COSTA RICA
7	HERNANDEZ QUIROZ ROBERTA		MEX - MEXICO

U14 KUMITE FEMALE -52 KG



Karate1 Youth League - Cancun 2024
ENTRIES BY WEIGHT CATEGORY



U14 Kumite Female -52 kg
As of 11 AUG 2024

NOC Code	Gender	Name	Seeding
CHI	F	VEGA BUSTAMANTE AMANDA	
ESP	F	Mazariegos Iglesias Esther	
ESP	F	MELGAR POSTIGO JULIA MARIA	
GER	F	Förster Alexia	
MEX	F	HERNANDEZ YANEZ FRIDA NICOLE	
MEX	F	RIVERA RODRIGUEZ JADE GETSEMANI	
PER	F	La Serna Hilario Grecia Beatriz	
PER	F	Yuffra Mirez Luana María	
USA	F	Arcalean Mihaela	
USA	F	Kumsi Ameya	

U14 Kumite Female -52 kg

Karate1 Youth League - Cancun 2024, Iberostar Playa Paraíso Convention Center, Avenida del Sol Km 309, Playa Paraiso, 77710 Riviera Maya, MEX

2024-08-11

Tatami
2 11:05

Pool
1/1

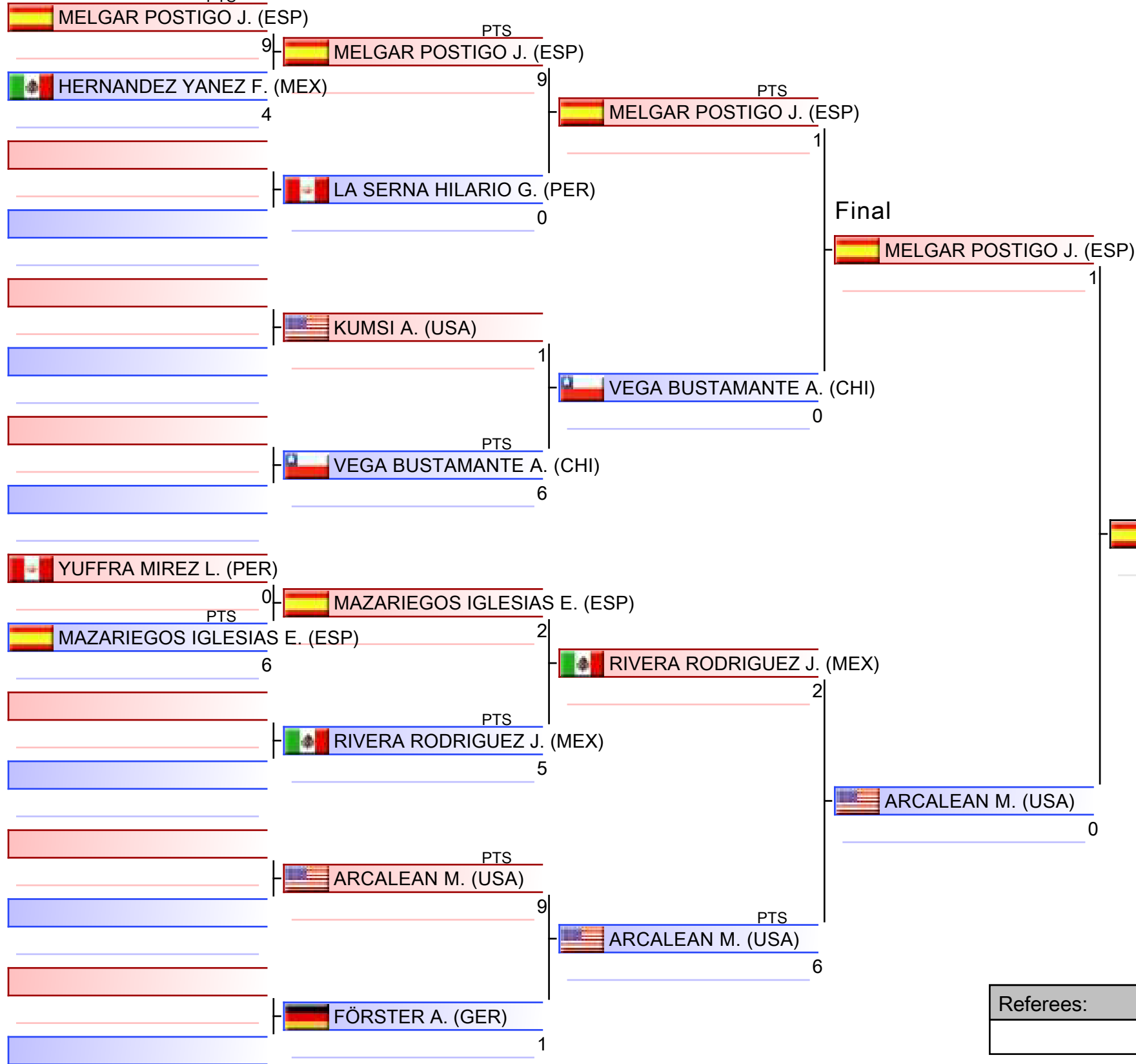

1. MELGAR POSTIGO JULIA MARIA (ESP)
2. ARCALEAN MIHAELA (USA)
3. HERNANDEZ YANEZ FRIDA NICOLE (MEX)
3. FÖRSTER ALEXIA (GER)
5. VEGA BUSTAMANTE AMANDA (CHI)
5. RIVERA RODRIGUEZ JADE GETSEMANI (MEX)
7. LA SERNA HILARIO GRECIA BEATRIZ (PER)

Referees:			

U14 Kumite Female -52 kg

Karate1 Youth League - Cancun 2024

2024-08-11

Tatami
2 11:40

Pool
1

(c)sportdata GmbH & Co KG 2000-2024 (2024-08-11 14:42) v 10.2.0 build 1 (2024-08-09 20:34 CET) License: Online_Event_ID-875_Karate1YouthLeagueCancun2024 (expire 2024-08-25)

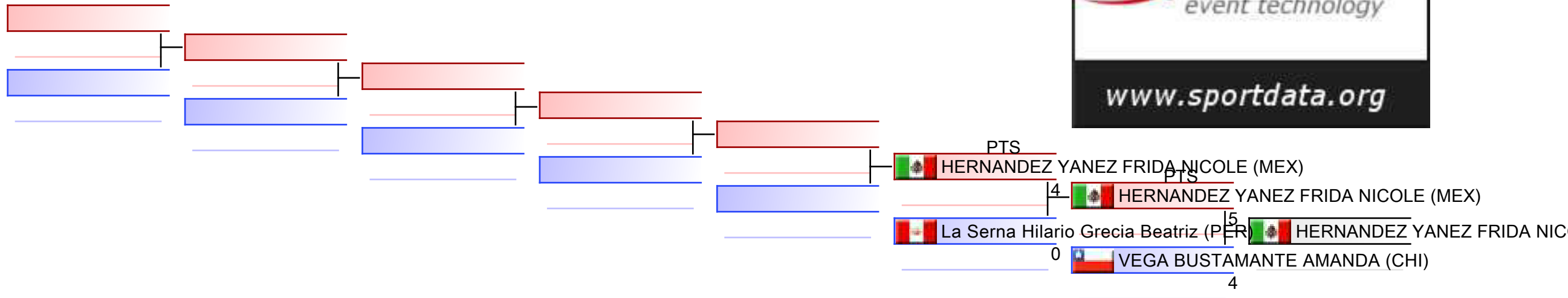

REPECHAGE: (1)

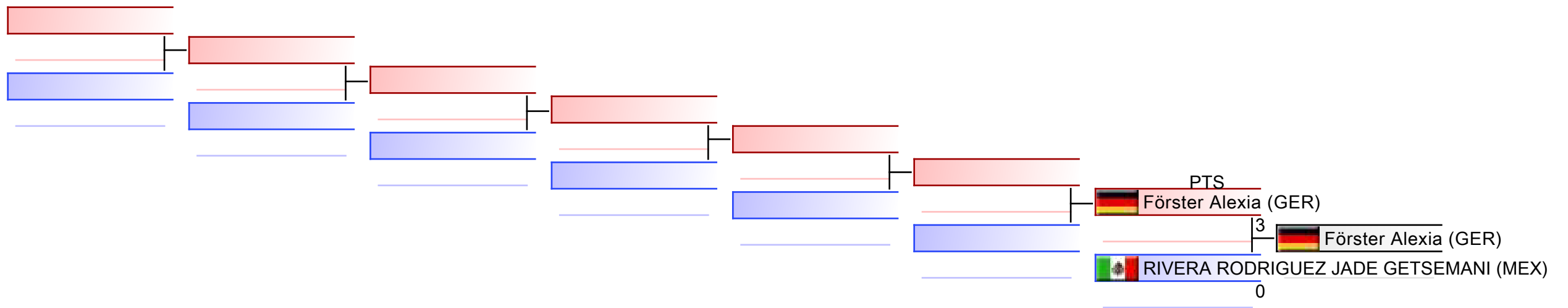

Referees:							
-----------	--	--	--	--	--	--	--



Karate1 Youth League - Cancun 2024 - 2024-08-08



Official Results

U14 Kumite Female -52 kg			
1	MELGAR POSTIGO JULIA MARIA		ESP - SPAIN
2	ARCALEAN MIHAELA		USA - UNITED STATES
3	HERNANDEZ YANEZ FRIDA NICOLE		MEX - MEXICO
3	FÖRSTER ALEXIA		GER - GERMANY
5	VEGA BUSTAMANTE AMANDA		CHI - CHILE
5	RIVERA RODRIGUEZ JADE GETSEMANI		MEX - MEXICO
7	LA SERNA HILARIO GRECIA BEATRIZ		PER - PERU

U14 KUMITE FEMALE 52+ KG



Karate1 Youth League - Cancun 2024
ENTRIES BY WEIGHT CATEGORY



U14 Kumite Female 52+ kg
As of 11 AUG 2024

NOC Code	Gender	Name	Seeding
BIH	F	Omanović Lamija	
CHI	F	ANTIPA GONZALEZ MAILEN	
CHI	F	AROS REBOLLEDO EMILIA	
ENG	F	HANDLEY SKYLA	
GER	F	Hoerner Frieda	
MEX	F	FRIAS CABRAL MELINA	
MEX	F	GARCIA ARELLANO NAOMI ALOTL	
MEX	F	RUIZ PEREZ MARIA FERNANDA	
PAR	F	BENITEZ LUCIA	
USA	F	Nguyen Katelyn	

U14 Kumite Female 52+ kg

Karate1 Youth League - Cancun 2024, Iberostar Playa Paraíso Convention Center, Avenida del Sol Km 309, Playa Paraiso, 77710 Riviera Maya, MEX

2024-08-11

Tatami

4 12:05

Pool

1/1

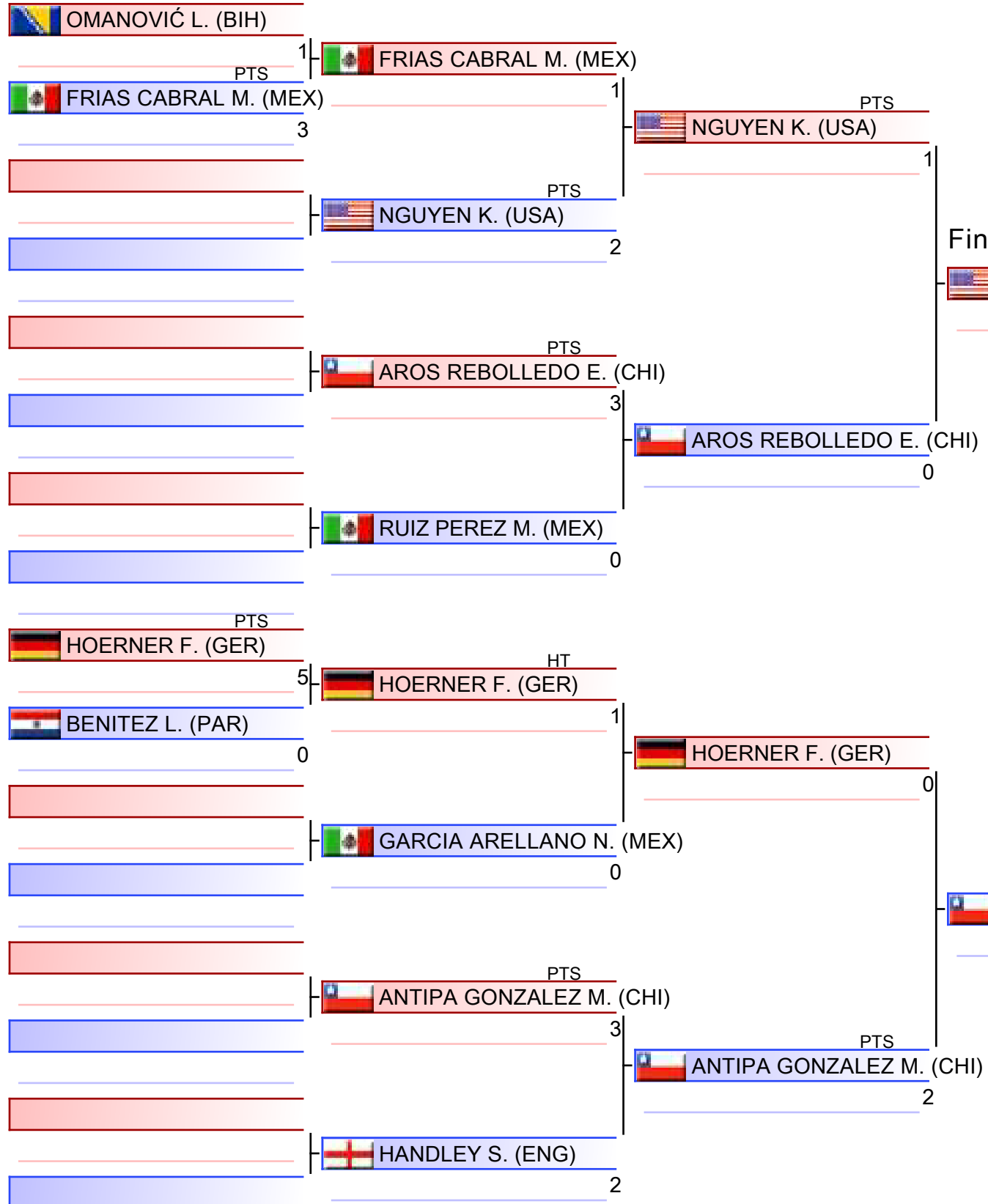

1. NGUYEN KATELYN (USA)
2. ANTIPA GONZALEZ MAILEN (CHI)
3. AROS REBOLLEDO EMILIA (CHI)
3. HOERNER FRIEDA (GER)
5. FRIAS CABRAL MELINA (MEX)
5. HANDLEY SKYLA (ENG)

Referees:			

U14 Kumite Female 52+ kg

Karate1 Youth League - Cancun 2024

2024-08-11

Tatami
4 12:40

Pool
1

(c)sportdata GmbH & Co KG 2000-2024 (2024-08-11 14:42) v 10.2.0 build 1 (2024-08-09 20:34 CET) License: Online_Event_ID-875_Karate1YouthLeagueCancun2024 (expire 2024-08-25)

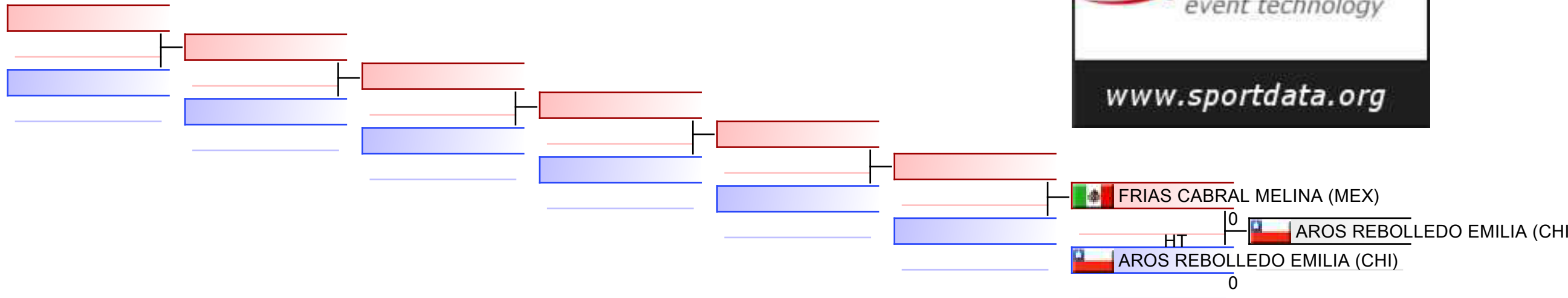

REPECHAGE: (1)

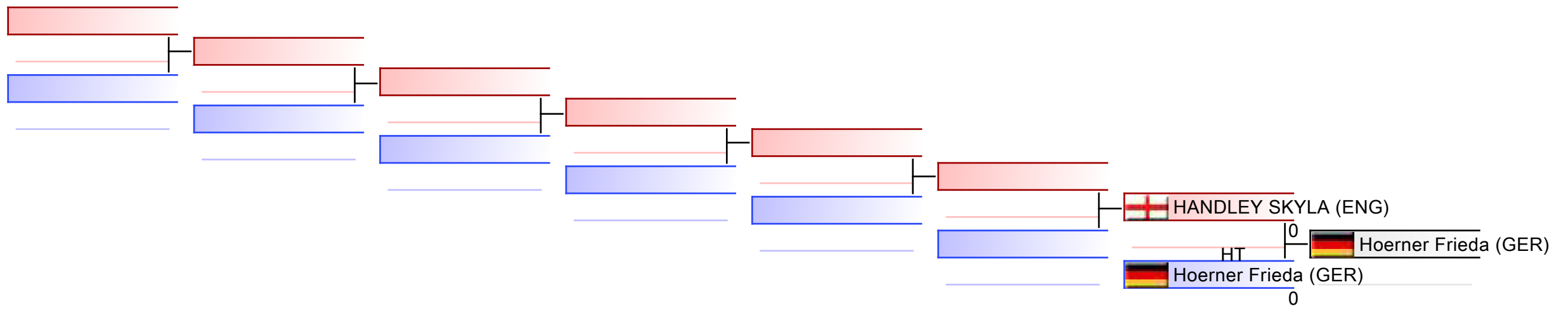







Referees:							
-----------	--	--	--	--	--	--	--



Karate1 Youth League - Cancun 2024 - 2024-08-08



Official Results

U14 Kumite Female 52+ kg			
1	NGUYEN KATELYN		USA - UNITED STATES
2	ANTIPA GONZALEZ MAILEN		CHI - CHILE
3	AROS REBOLLEDO EMILIA		CHI - CHILE
3	HOERNER FRIEDA		GER - GERMANY
5	FRIAS CABRAL MELINA		MEX - MEXICO
5	HANDLEY SKYLA		ENG - ENGLAND

U14 KUMITE MALE +55 KG



Karate1 Youth League - Cancun 2024
ENTRIES BY WEIGHT CATEGORY



U14 Kumite Male +55 kg
As of 11 AUG 2024

NOC Code	Gender	Name	Seeding
CAN	M	SAJADI PARSA	
CHI	M	BUSTAMANTE ALVARADO LEANDRO	
CHI	M	Campusano Matías	
CHI	M	HERNANDEZ NAVARRO MATHIAS	
CHI	M	SALAS HERNANDEZ DILAN	
ESP	M	Gomez Jimenez Francisco Javier	
GER	M	Azadi Bijan	
GER	M	Gräfe Lukas	
GER	M	Pagin Lukasz	
MEX	M	GARCIA ROCHA JOSE LUIS	
MEX	M	OLIVAS ROMERO PABLO ANTONIO	
PER	M	Honorio Velasco Alvaro Manuel	
USA	M	OUSMANE NIANG	
VEN	M	IGNACIO RIOS	

U14 Kumite Male +55 kg

Karate1 Youth League - Cancun 2024, Iberostar Playa Paraíso Convention Center, Avenida del Sol Km 309, Playa Paraiso, 77710 Riviera Maya, MEX

2024-08-11

Tatami

1 12:30

Pool

1/2

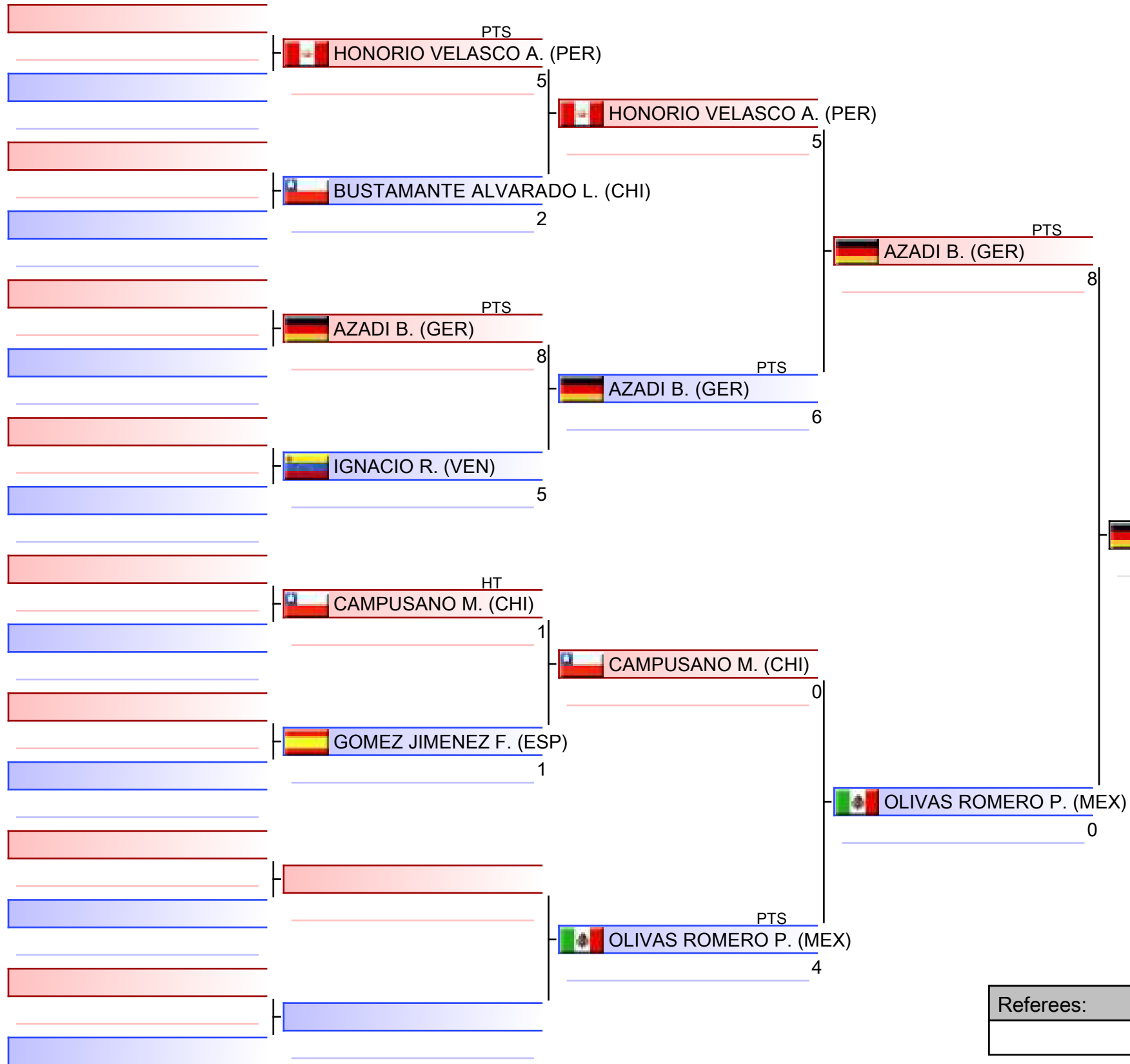

1. PAGIN LUKASZ (GER)
2. AZADI BIJAN (GER)
3. OUSMANE NIANG (USA)
3. HONORIO VELASCO ALVARO MANUEL (PER)
5. GARCIA ROCHA JOSE LUIS (MEX)
5. OLIVAS ROMERO PABLO ANTONIO (MEX)
7. HERNANDEZ NAVARRO MATHIAS (CHI)
7. IGNACIO RIOS (VEN)

Referees:			

U14 Kumite Male +55 kg

Karate1 Youth League - Cancun 2024, Iberostar Playa Paraíso Convention Center, Avenida del Sol Km 309, Playa Paraiso, 77710 Riviera Maya, MEX

2024-08-11

Tatami
2 12:45

Pool
2/2

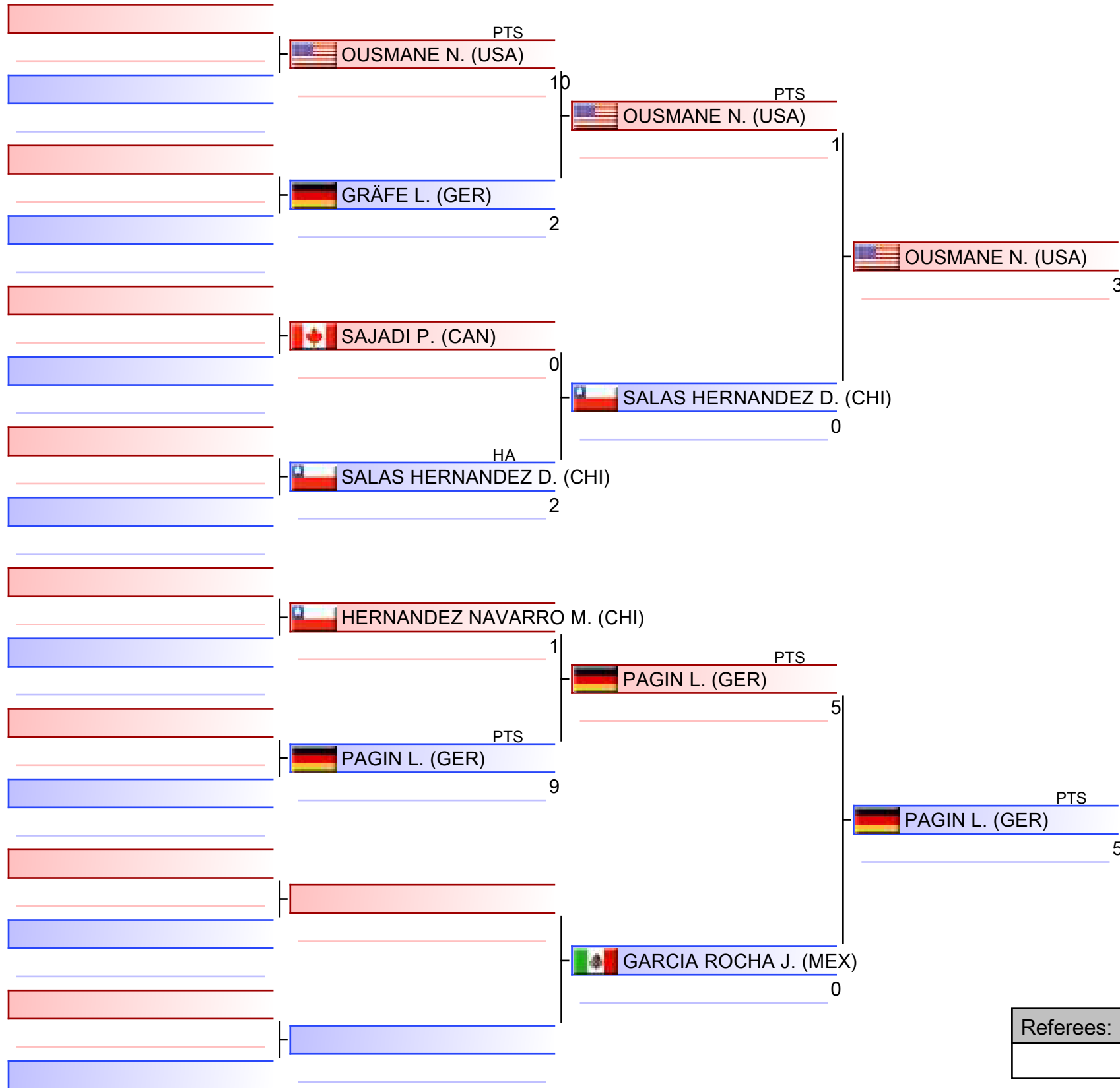

1. PAGIN LUKASZ (GER)
2. AZADI BIJAN (GER)
3. OUSMANE NIANG (USA)
3. HONORIO VELASCO ALVARO MANUEL (PER)
5. GARCIA ROCHA JOSE LUIS (MEX)
5. OLIVAS ROMERO PABLO ANTONIO (MEX)
7. HERNANDEZ NAVARRO MATHIAS (CHI)
7. IGNACIO RIOS (VEN)

Referees:			

Pool winner-U14 Kumite Male +55 kg

Karate1 Youth League - Cancun 2024, Iberostar Playa Paraiso Convention Center, Avenida del Sol Km 309, Playa Paraiso, 77710 Riviera Maya, MEX

Tatami

Pool

1/1

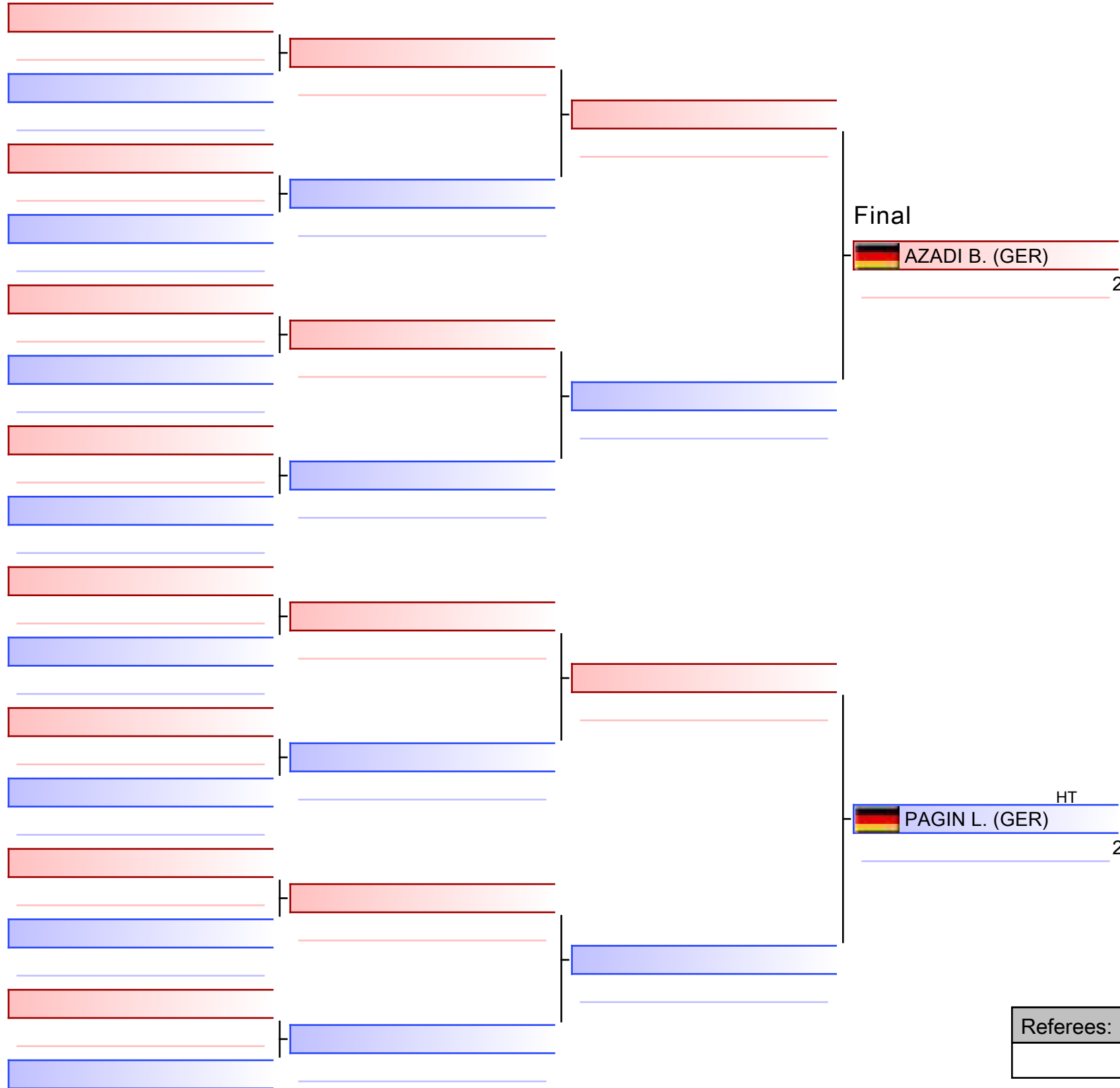

1. PAGIN LUKASZ (GER)
2. AZADI BIJAN (GER)
3. OUSMANE NIANG (USA)
3. HONORIO VELASCO ALVARO MANUEL (PER)
5. GARCIA ROCHA JOSE LUIS (MEX)
5. OLIVAS ROMERO PABLO ANTONIO (MEX)
7. HERNANDEZ NAVARRO MATHIAS (CHI)
7. IGNACIO RIOS (VEN)

Referees:			

U14 Kumite Male +55 kg

Karate1 Youth League - Cancun 2024

2024-08-11

Tatami
1 12:55

Pool
1

(c)sportdata GmbH & Co KG 2000-2024 (2024-08-11 14:42) v 10.2.0 build 1 (2024-08-09 20:34 CET) License: Online_Event_ID-875_Karate1YouthLeagueCancun2024 (expire 2024-08-25)

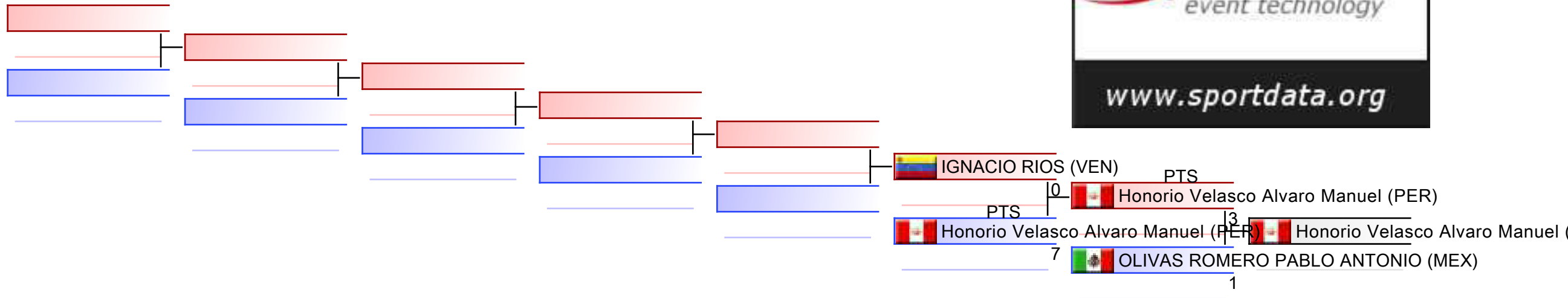

REPECHAGE: (1)

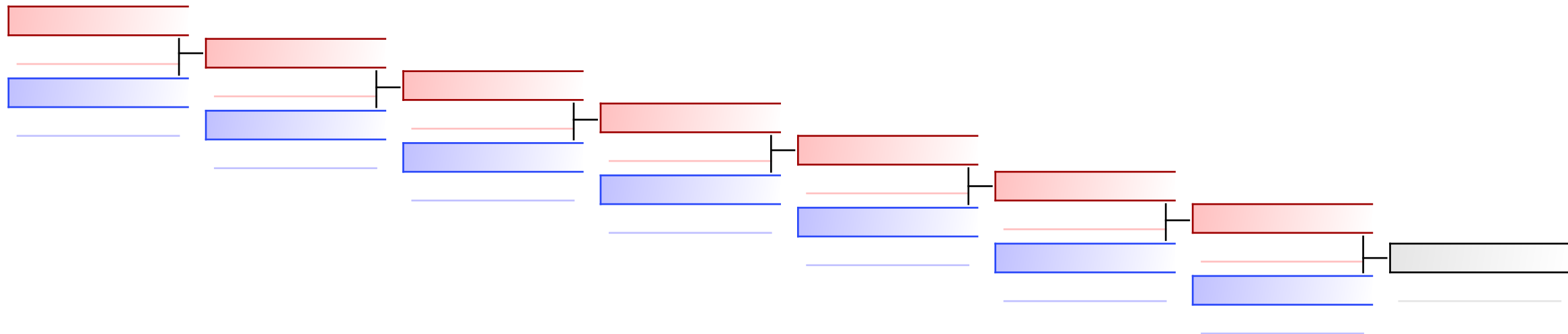

Referees:							
-----------	--	--	--	--	--	--	--

U14 Kumite Male +55 kg

Karate1 Youth League - Cancun 2024

2024-08-11

Tatami
2 13:10

Pool
2

(c)sportdata GmbH & Co KG 2000-2024 (2024-08-11 14:42) v 10.2.0 build 1 (2024-08-09 20:34 CET) License: Online_Event_ID-875_Karate1YouthLeagueCancun2024 (expire 2024-08-25)

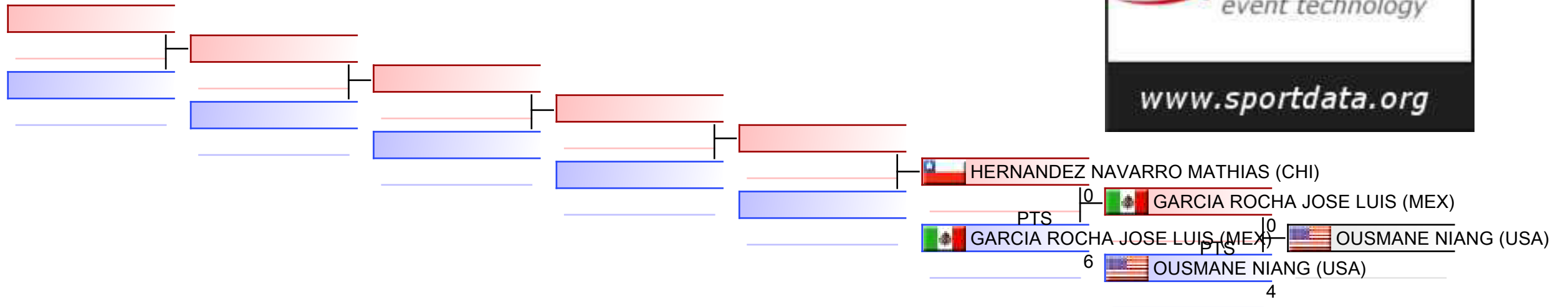

REPECHAGE: (2)

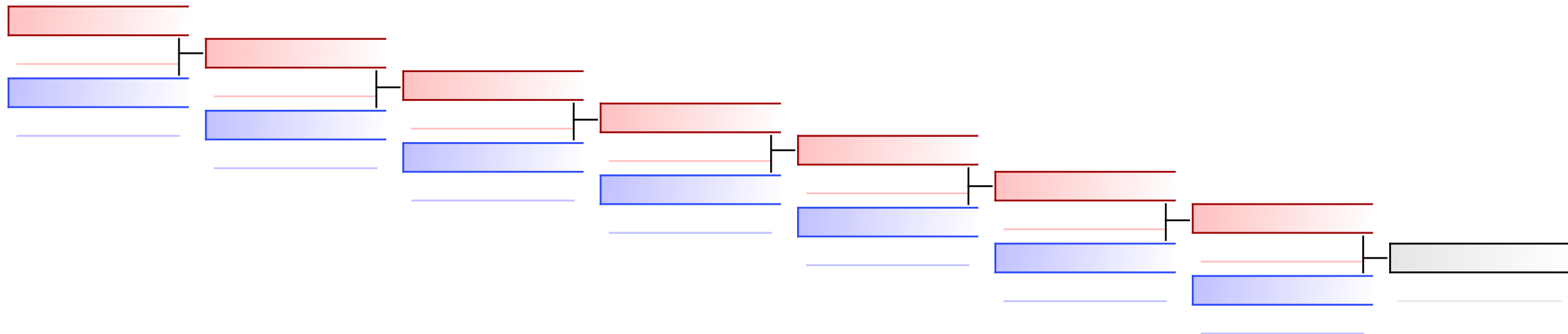

Referees:							
-----------	--	--	--	--	--	--	--



Karate1 Youth League - Cancun 2024 - 2024-08-08



Official Results

U14 Kumite Male +55 kg			
1	PAGIN LUKASZ		GER - GERMANY
2	AZADI BIJAN		GER - GERMANY
3	OUSMANE NIANG		USA - UNITED STATES
3	HONORIO VELASCO ALVARO MANUEL		PER - PERU
5	GARCIA ROCHA JOSE LUIS		MEX - MEXICO
5	OLIVAS ROMERO PABLO ANTONIO		MEX - MEXICO
7	HERNANDEZ NAVARRO MATHIAS		CHI - CHILE
7	IGNACIO RIOS		VEN - VENEZUELA

U14 KUMITE MALE -40 KG



Karate1 Youth League - Cancun 2024
ENTRIES BY WEIGHT CATEGORY



U14 Kumite Male -40 kg
As of 11 AUG 2024

NOC Code	Gender	Name	Seeding
CAN	M	HOBSON CHASE	
CHI	M	MARTINEZ SAGREDO LEON	
CRC	M	GONZALES MOISES	
MEX	M	ALCAZAR RUIZ FRANCISCO JAVIER YASYDT	
MEX	M	AMBROSIO PENA ROGELIO ANTONIO	
MEX	M	BOJORQUEZ ARCE BRANDON VLADIMIR	
MEX	M	PEREZ KASUGA MARIO ALBERTO SHINJI	
MEX	M	ROBLES CASTRO CARLOS KALEB	
PER	M	Lavado Rojas Giordano Ghael	
USA	M	BARNABEI MASSIMO	
USA	M	Shaikh Aariz	
USA	M	Shaikh Ryaz	

U14 Kumite Male -40 kg

Karate1 Youth League - Cancun 2024, Iberostar Playa Paraíso Convention Center, Avenida del Sol Km 309, Playa Paraiso, 77710 Riviera Maya, MEX

2024-08-11

Tatami
3 11:05

Pool
1/1

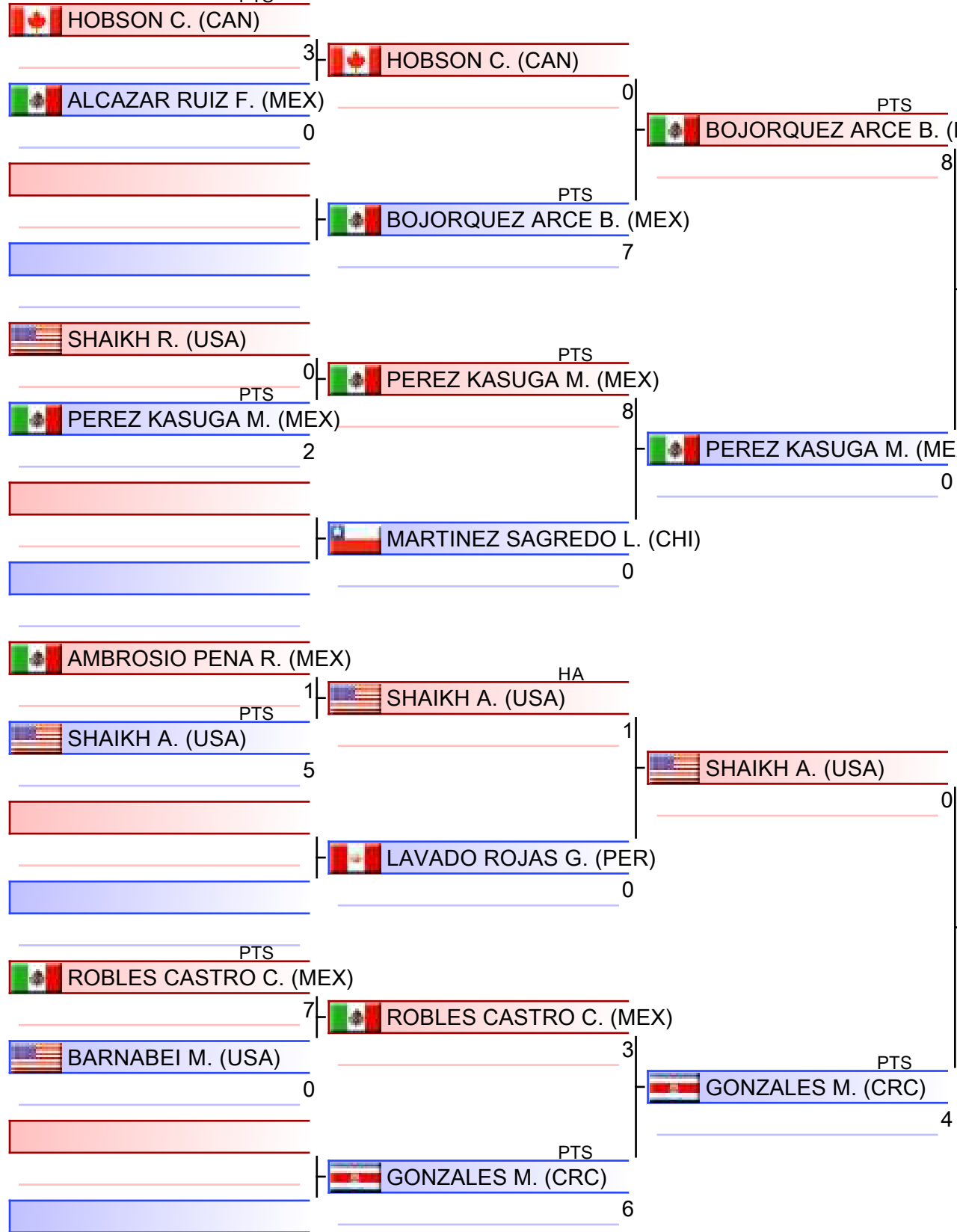

1. GONZALES MOISES (CRC)
2. BOJORQUEZ ARCE BRANDON VLADIMIR (MEX)
3. ROBLES CASTRO CARLOS KALEB (MEX)
3. PEREZ KASUGA MARIO ALBERTO SHINJI (MEX)
5. SHAIKH AARIZ (USA)
5. HOBSON CHASE (CAN)

Referees:			

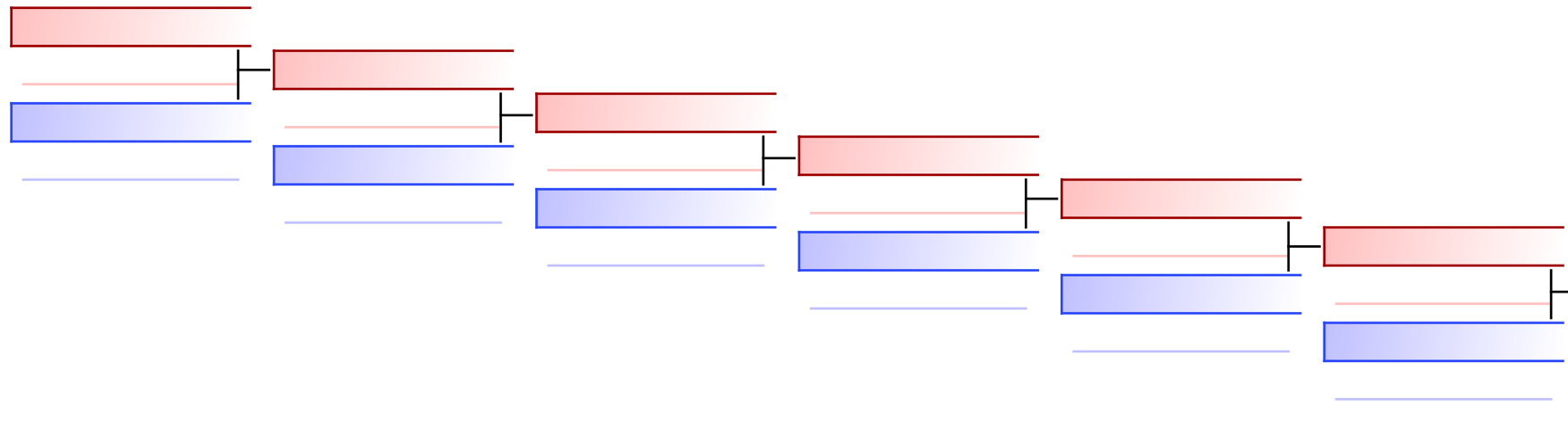

HOBSON CHASE (CAN) PTS 2
 PEREZ KASUGA MARIO ALBERTO SHINJI (MEX) PTS 4

REPECHAGE: (1)

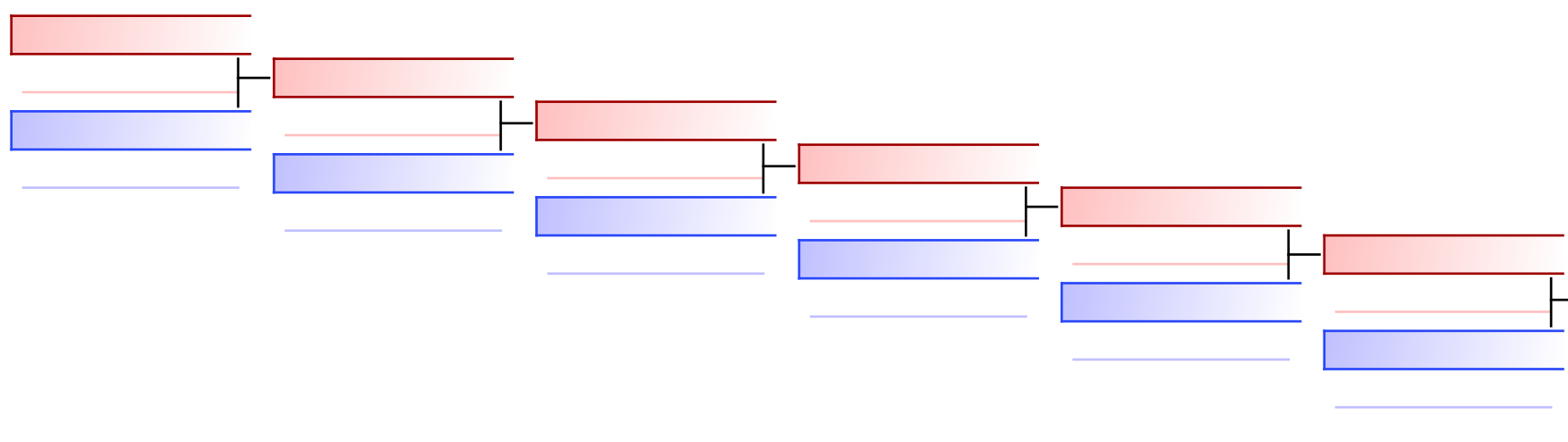

ROBLES CASTRO CARLOS KALEB (MEX) PTS 3
 Shaikh Aariz (USA) PTS 2

Referees:							
-----------	--	--	--	--	--	--	--



Karate1 Youth League - Cancun 2024 - 2024-08-08



Official Results

U14 Kumite Male -40 kg			
1	GONZALES MOISES		CRC - COSTA RICA
2	BOJORQUEZ ARCE BRANDON VLADIMIR		MEX - MEXICO
3	ROBLES CASTRO CARLOS KALEB		MEX - MEXICO
3	PEREZ KASUGA MARIO ALBERTO SHINJI		MEX - MEXICO
5	SHAIKH AARIZ		USA - UNITED STATES
5	HOBSON CHASE		CAN - CANADA

U14 KUMITE MALE -45 KG



Karate1 Youth League - Cancun 2024
ENTRIES BY WEIGHT CATEGORY



U14 Kumite Male -45 kg
As of 11 AUG 2024

NOC Code	Gender	Name	Seeding
BRA	M	Miranda Vaz Murillo	
CAN	M	Palanisamy Arun Adit	
CHI	M	BAHAMONDE AGUSTIN	
CHI	M	Navarrete Sebastián	
CHI	M	Sotomayor Villaroel Benjamin	
GER	M	Grünelt Oliver	
JAM	M	EVANS VALENTINO RASANDRE	
MEX	M	CABALLERO AQUINO LUIS ERNESTO	
MEX	M	Cervantes Vazquez Vishwambar Jan	
MEX	M	CETINA VALLEJOS NOEL ABISAI	
MEX	M	D FLON VASQUEZ KAILASH TARIK	
MEX	M	SANTIAGO ZAVALA AXEL MANUEL	
USA	M	Bonetti Akiau Luigi	
USA	M	Sanchez Luis	
USA	M	Sattanathan Sivanandh	
USA	M	SEKOU BEN STEPHAN TIMITE	

U14 Kumite Male -45 kg

Karate1 Youth League - Cancun 2024, Iberostar Playa Paraíso Convention Center, Avenida del Sol Km 309, Playa Paraiso, 77710 Riviera Maya, MEX

2024-08-11

Tatami

2 11:55

Pool

1/2

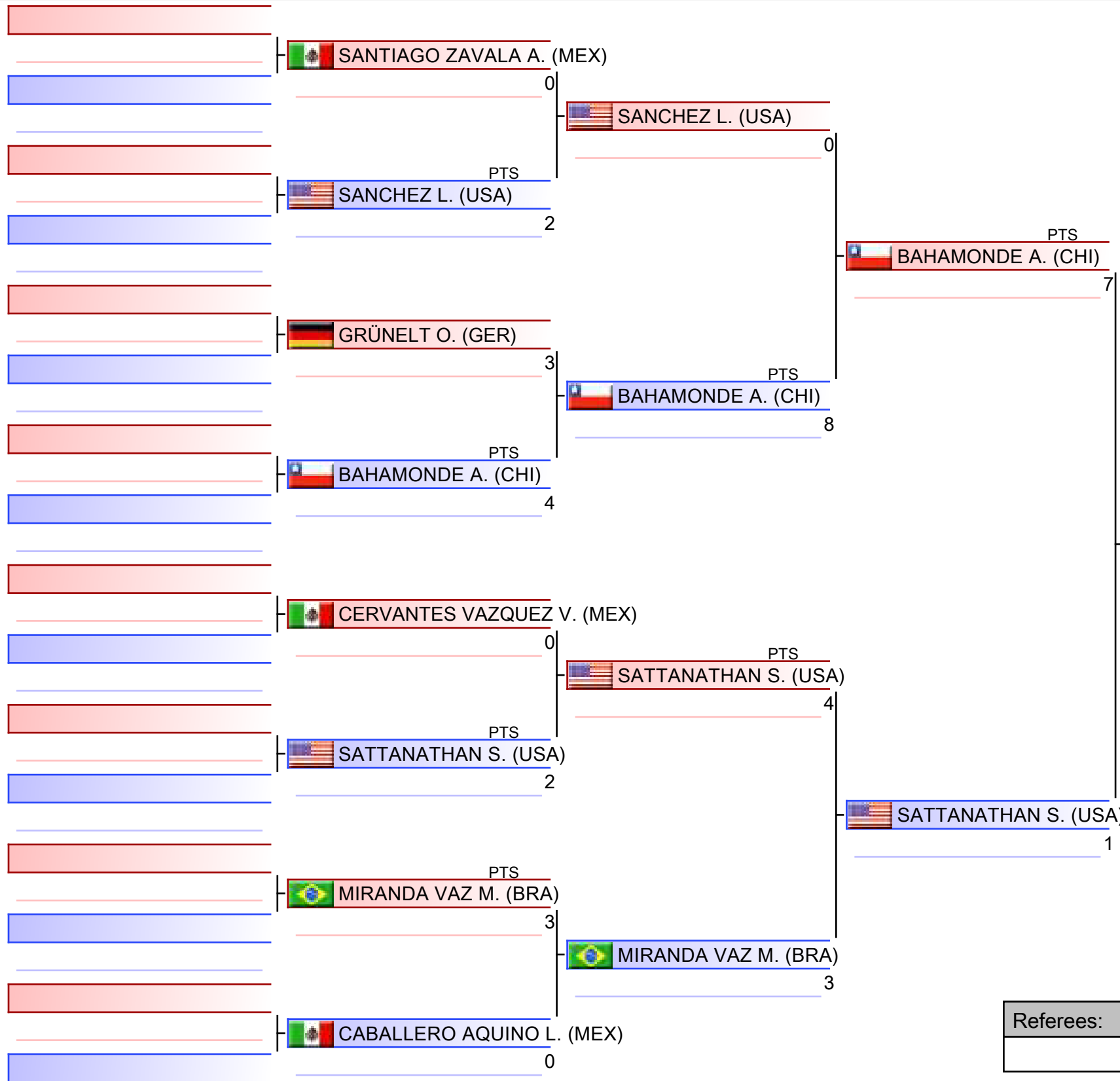

- | |
|--|
| 1. SOTOMAYOR VILLAROEEL BENJAMIN (CHI) |
| 2. BAHAMONDE AGUSTIN (CHI) |
| 3. SEKOU BEN STEPHAN TIMITE (USA) |
| 3. GRÜNELT OLIVER (GER) |
| 5. BONETTI AKIAU LUIGI (USA) |
| 5. SATTANATHAN SIVANANDH (USA) |
| 7. D FLON VASQUEZ KAILASH TARIK (MEX) |
| 7. SANCHEZ LUIS (USA) |

Referees:			

U14 Kumite Male -45 kg

Karate1 Youth League - Cancun 2024, Iberostar Playa Paraíso Convention Center, Avenida del Sol Km 309, Playa Paraiso, 77710 Riviera Maya, MEX

2024-08-11

Tatami

3 12:00

Pool

2/2

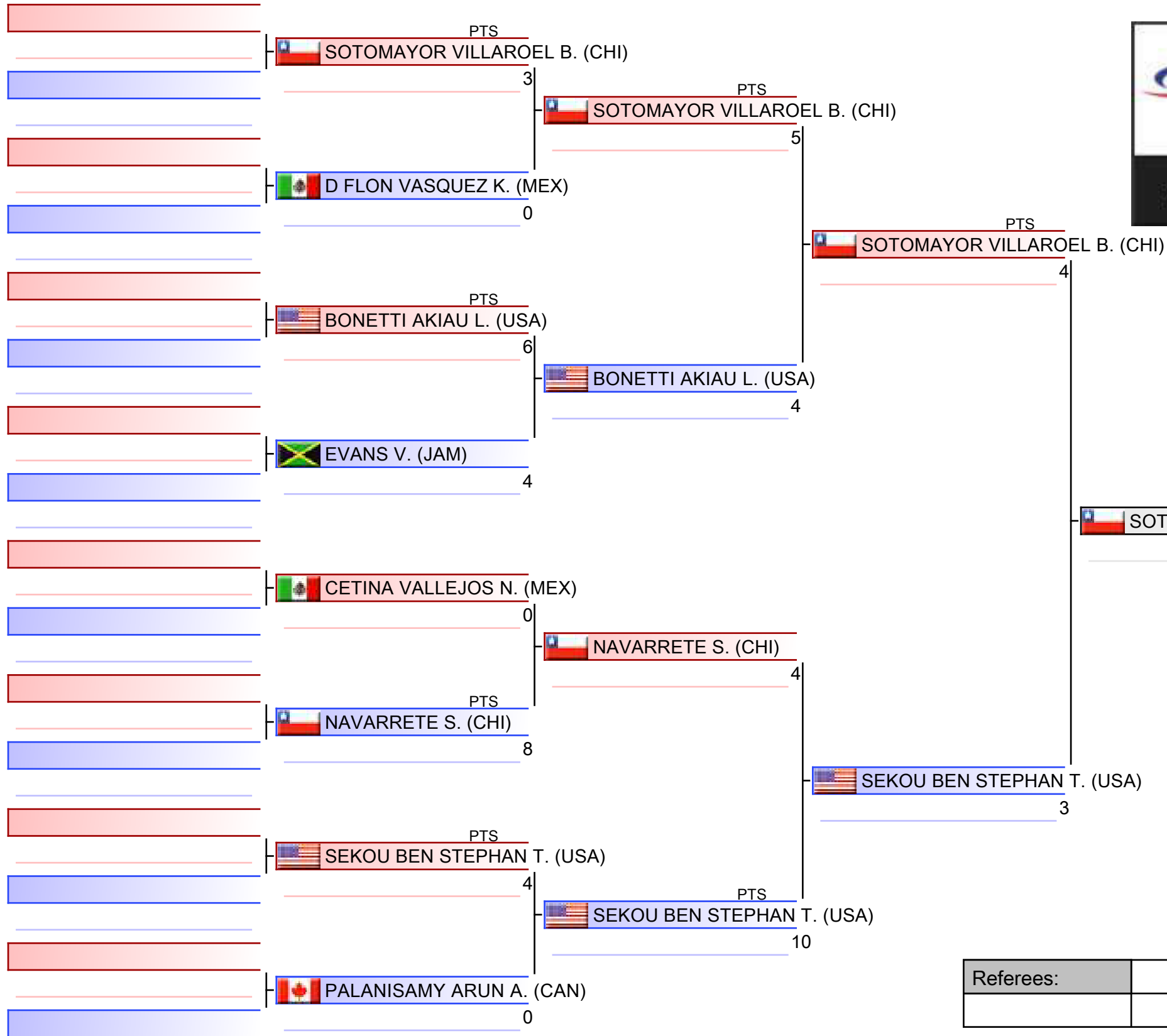

- | |
|---------------------------------------|
| 1. SOTOMAYOR VILLAROEL BENJAMIN (CHI) |
| 2. BAHAMONDE AGUSTIN (CHI) |
| 3. SEKOU BEN STEPHAN TIMITE (USA) |
| 3. GRÜNELT OLIVER (GER) |
| 5. BONETTI AKIAU LUIGI (USA) |
| 5. SATTANATHAN SIVANANDH (USA) |
| 7. D FLON VASQUEZ KAILASH TARIK (MEX) |
| 7. SANCHEZ LUIS (USA) |

Referees:			

Pool winner-U14 Kumite Male -45 kg

Karate1 Youth League - Cancun 2024, Iberostar Playa Paraiso Convention Center, Avenida del Sol Km 309, Playa Paraiso, 77710 Riviera Maya, MEX

Tatami

Pool

1/1

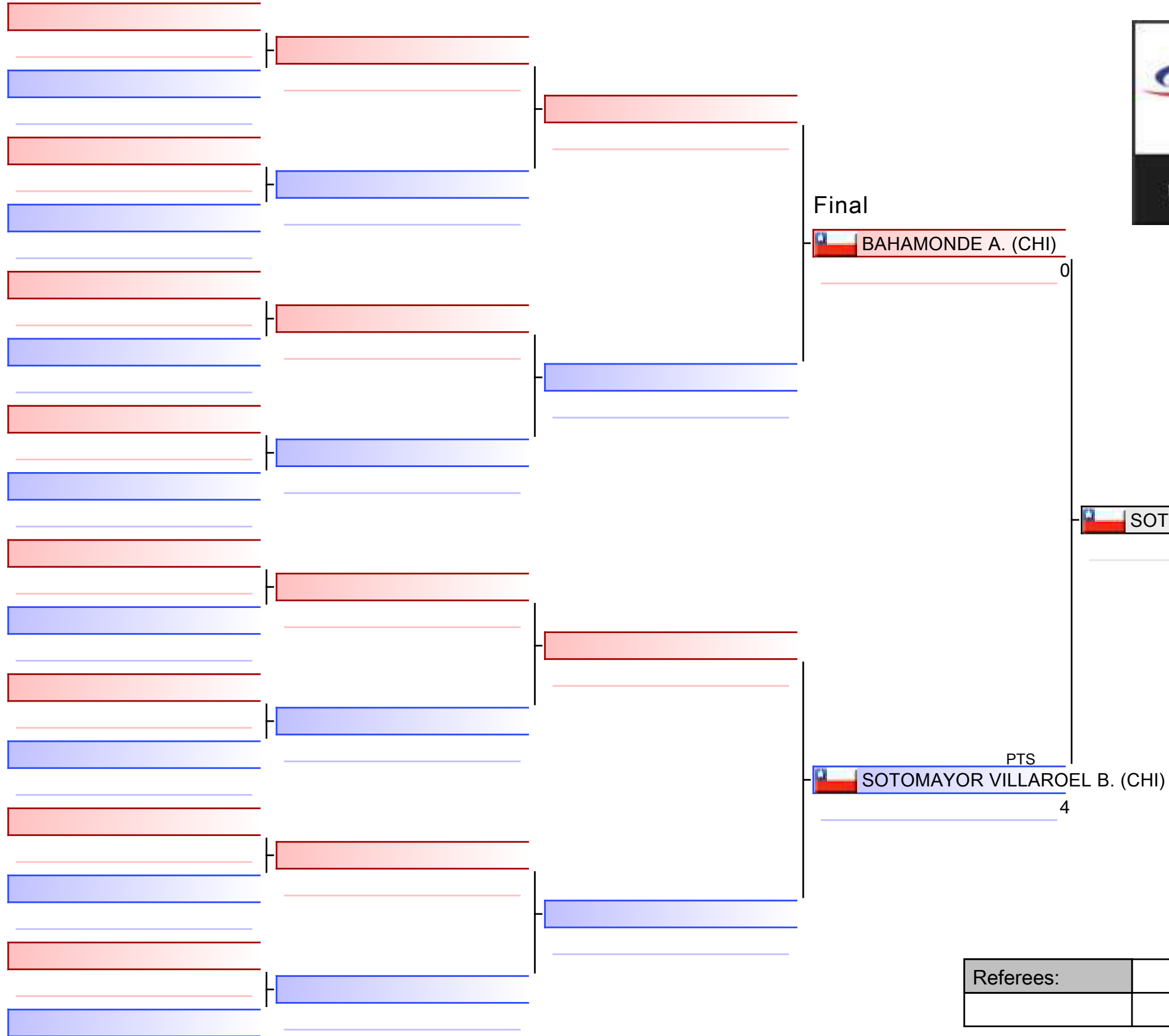

- | |
|--|
| 1. SOTOMAYOR VILLAROEEL BENJAMIN (CHI) |
| 2. BAHAMONDE AGUSTIN (CHI) |
| 3. SEKOU BEN STEPHAN TIMITE (USA) |
| 3. GRÜNELT OLIVER (GER) |
| 5. BONETTI AKIAU LUIGI (USA) |
| 5. SATTANATHAN SIVANANDH (USA) |
| 7. D FLON VASQUEZ KAILASH TARIK (MEX) |
| 7. SANCHEZ LUIS (USA) |

Referees:			

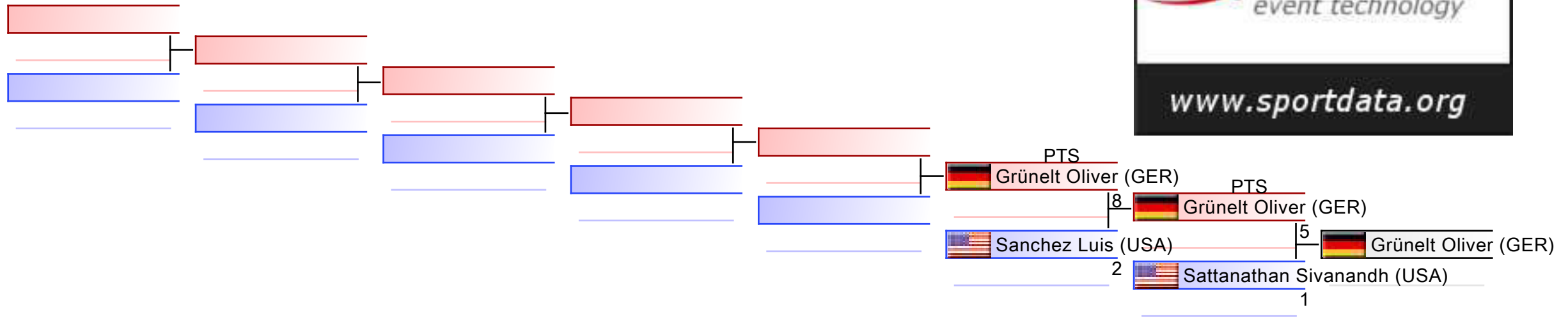

REPECHAGE: (1)

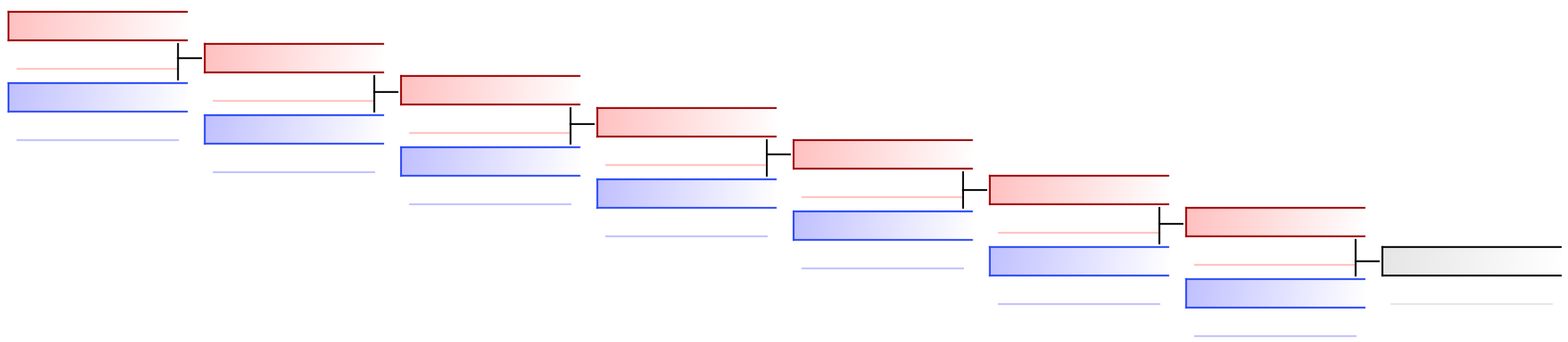

Referees:							
-----------	--	--	--	--	--	--	--

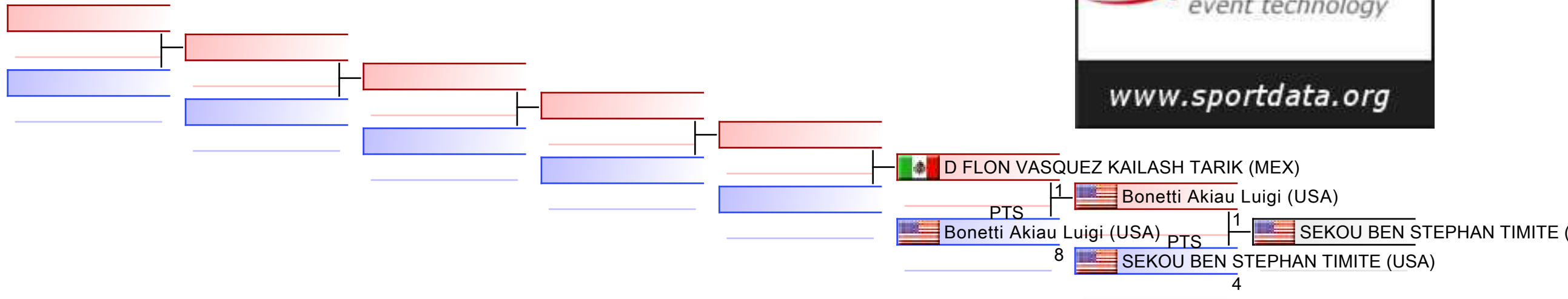

REPECHAGE: (2)

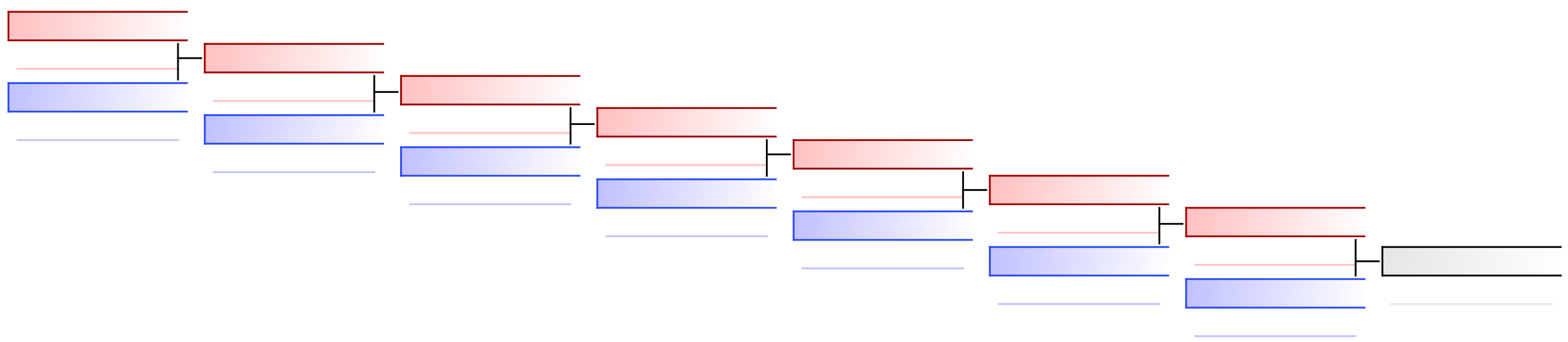

Referees:							
-----------	--	--	--	--	--	--	--



Karate1 Youth League - Cancun 2024 - 2024-08-08



Official Results

U14 Kumite Male -45 kg			
1	SOTOMAYOR VILLAROEEL BENJAMIN		CHI - CHILE
2	BAHAMONDE AGUSTIN		CHI - CHILE
3	SEKOU BEN STEPHAN TIMITE		USA - UNITED STATES
3	GRÜNELT OLIVER		GER - GERMANY
5	BONETTI AKIAU LUIGI		USA - UNITED STATES
5	SATTANATHAN SIVANANDH		USA - UNITED STATES
7	D FLON VASQUEZ KAILASH TARIK		MEX - MEXICO
7	SANCHEZ LUIS		USA - UNITED STATES

U14 KUMITE MALE -50 KG



Karate1 Youth League - Cancun 2024
ENTRIES BY WEIGHT CATEGORY



U14 Kumite Male -50 kg
As of 11 AUG 2024

NOC Code	Gender	Name	Seeding
CAN	M	Singh Evan	
CHI	M	CONTRERAS ORTIZ LUCAS	
CHI	M	MIRALLES PINEDA MATEO	
CRC	M	CORRALES NATAN	
CRC	M	JIMENEZ NICOLAS	
CRC	M	VILLALOBOS JUAN CAMILO	
ITA	M	Ferraris Giacomo	
MEX	M	GIL GONZALEZ PATRICIO	
MEX	M	MERCADO DE ANDA Abraham	
MEX	M	OROZCO TORRES JOSE HUMBERTO	
NCA	M	MONTEALEGRE VILLELA OSCAR GUSTAVO	
PAR	M	MARTINEZ ALBARO	
VEN	M	JESUS GARCIA	

U14 Kumite Male -50 kg

Karate1 Youth League - Cancun 2024, Iberostar Playa Paraíso Convention Center, Avenida del Sol Km 309, Playa Paraiso, 77710 Riviera Maya, MEX

2024-08-11

Tatami

4 11:05

Pool

1/1

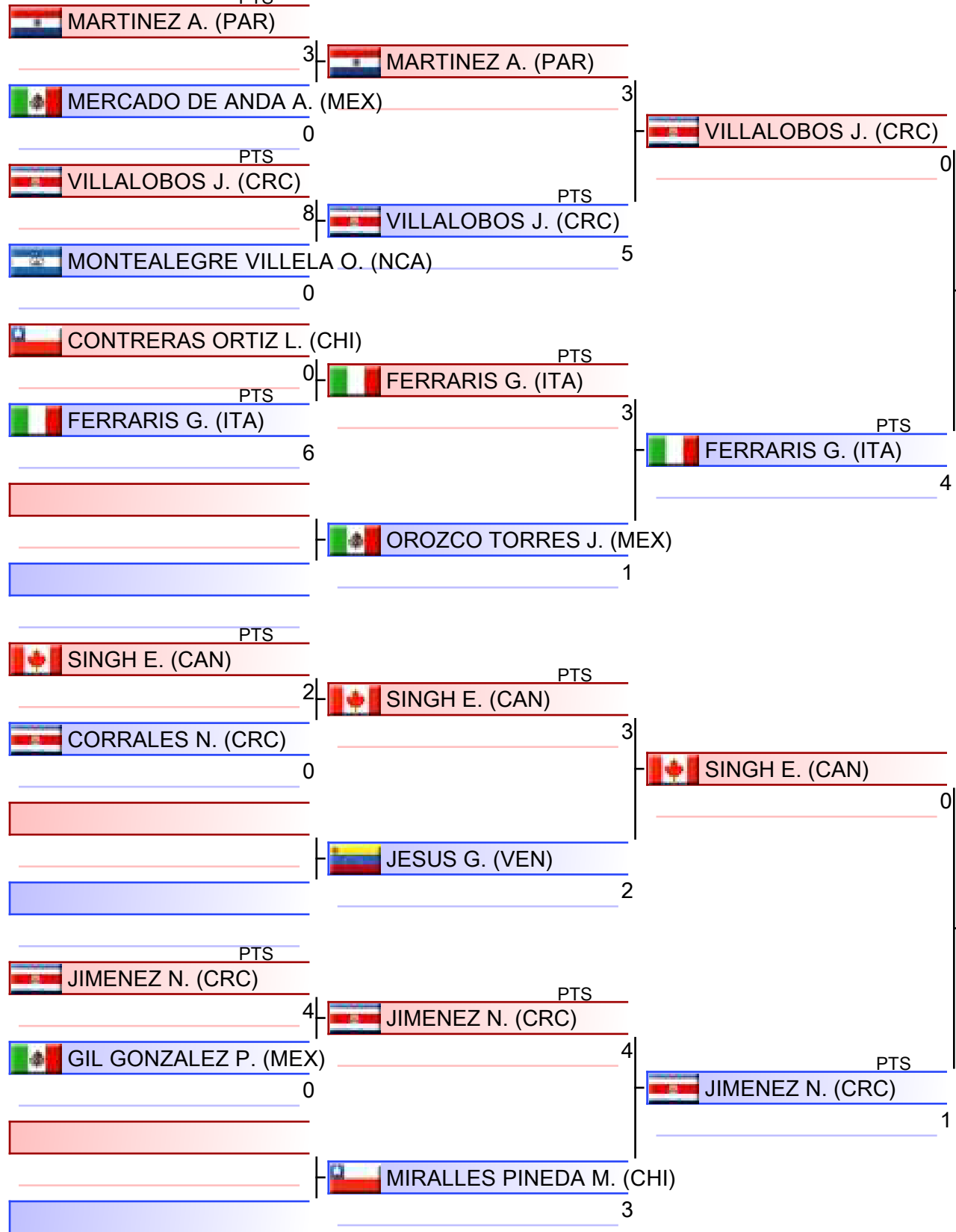

Final



- | |
|--------------------------------------|
| 1. FERRARIS GIACOMO (ITA) |
| 2. JIMENEZ NICOLAS (CRC) |
| 3. CONTRERAS ORTIZ LUCAS (CHI) |
| 3. MIRALLES PINEDA MATEO (CHI) |
| 5. VILLALOBOS JUAN CAMILO (CRC) |
| 5. SINGH EVAN (CAN) |
| 7. OROZCO TORRES JOSE HUMBERTO (MEX) |
| 7. GIL GONZALEZ PATRICIO (MEX) |

Referees:			

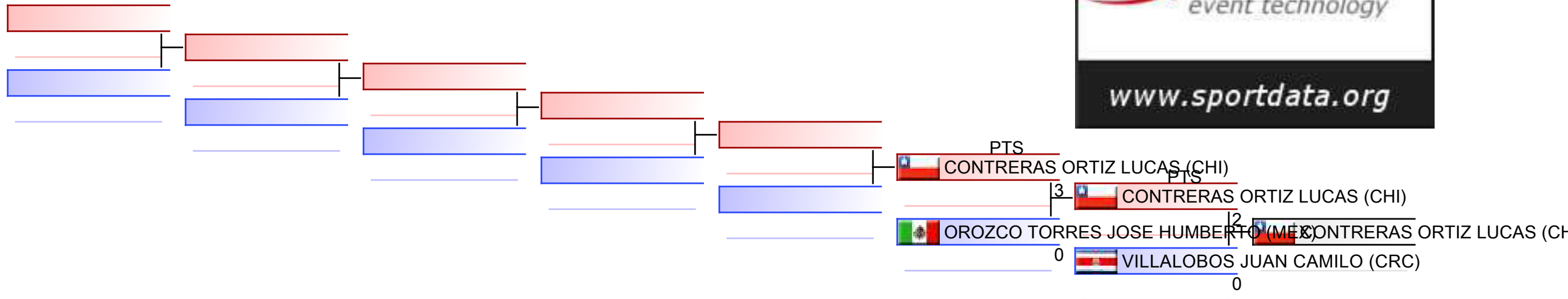

REPECHAGE: (1)

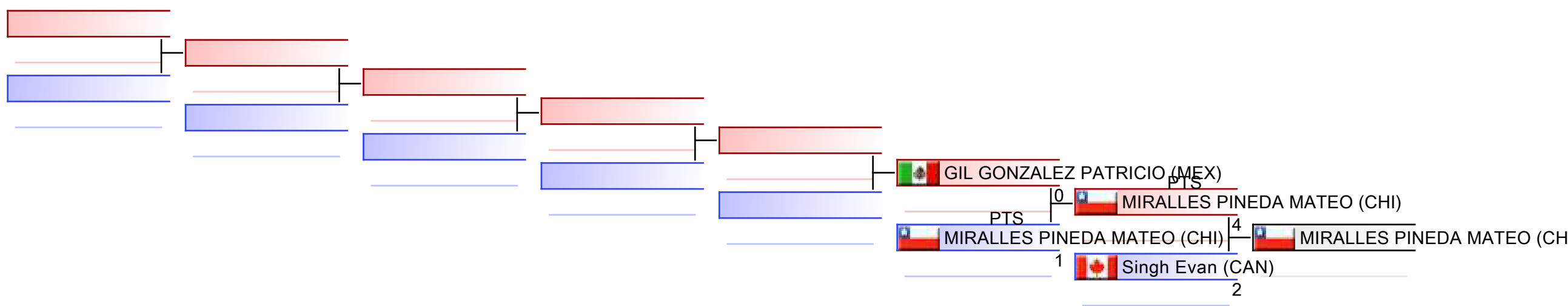

Referees:							
-----------	--	--	--	--	--	--	--



Karate1 Youth League - Cancun 2024 - 2024-08-08



Official Results

U14 Kumite Male -50 kg			
1	FERRARIS GIACOMO		ITA - ITALY
2	JIMENEZ NICOLAS		CRC - COSTA RICA
3	CONTRERAS ORTIZ LUCAS		CHI - CHILE
3	MIRALLES PINEDA MATEO		CHI - CHILE
5	VILLALOBOS JUAN CAMILO		CRC - COSTA RICA
5	SINGH EVAN		CAN - CANADA
7	OROZCO TORRES JOSE HUMBERTO		MEX - MEXICO
7	GIL GONZALEZ PATRICIO		MEX - MEXICO

U14 KUMITE MALE -55 KG



Karate1 Youth League - Cancun 2024
ENTRIES BY WEIGHT CATEGORY



U14 Kumite Male -55 kg
As of 11 AUG 2024

NOC Code	Gender	Name	Seeding
ESP	M	BENITEZ MORENO FRANCISCO	
MEX	M	ACOSTA PARICIO TOMAS	
MEX	M	CAAMAL PUC PEDRO RAFAEL	
MEX	M	CHAVEZ RAMIREZ Gerardo Gabriel	
MEX	M	DELGADO SANCHEZ SAUL ALEJANDRO	
MEX	M	HERNANDEZ JIMENEZ JULIAN	
MEX	M	PEREZ MENDEZ FRANCISCO DANIEL	
MEX	M	VELAZQUEZ OSUNA OLIVER LEONARDO	
PER	M	Ccoillo Ferrante Adriano Tadeo	

U14 Kumite Male -55 kg

Karate1 Youth League - Cancun 2024, Iberostar Playa Paraíso Convention Center, Avenida del Sol Km 309, Playa Paraiso, 77710 Riviera Maya, MEX

2024-08-11

Tatami

3 12:30

Pool

1/1

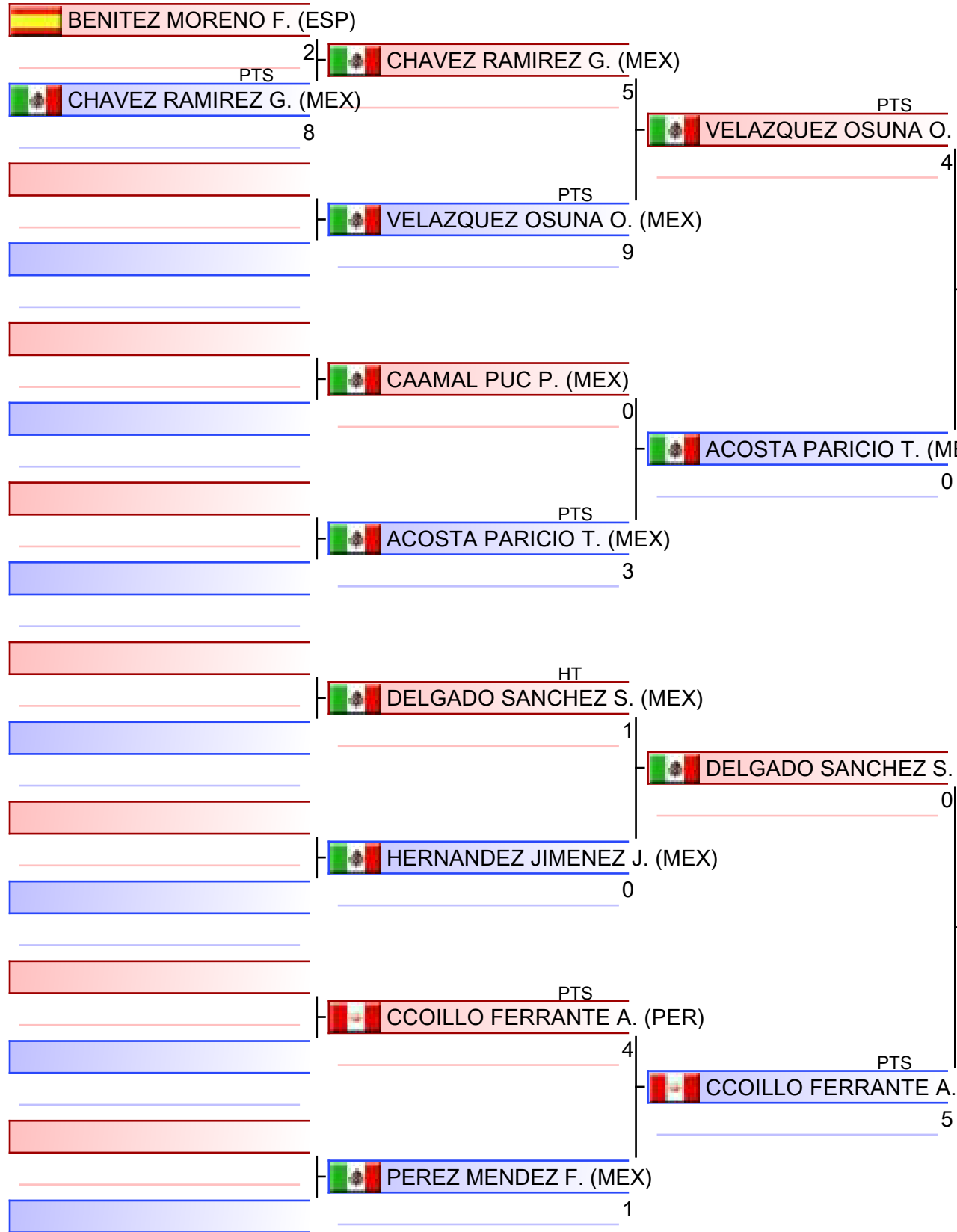

1.	VELAZQUEZ OSUNA OLIVER LEONARDO (MEX)
2.	CCOILLO FERRANTE ADRIANO TADEO (PER)
3.	CHAVEZ RAMIREZ GERARDO GABRIEL (MEX)
3.	DELGADO SANCHEZ SAUL ALEJANDRO (MEX)
5.	ACOSTA PARICIO TOMAS (MEX)
5.	PEREZ MENDEZ FRANCISCO DANIEL (MEX)

Referees:			

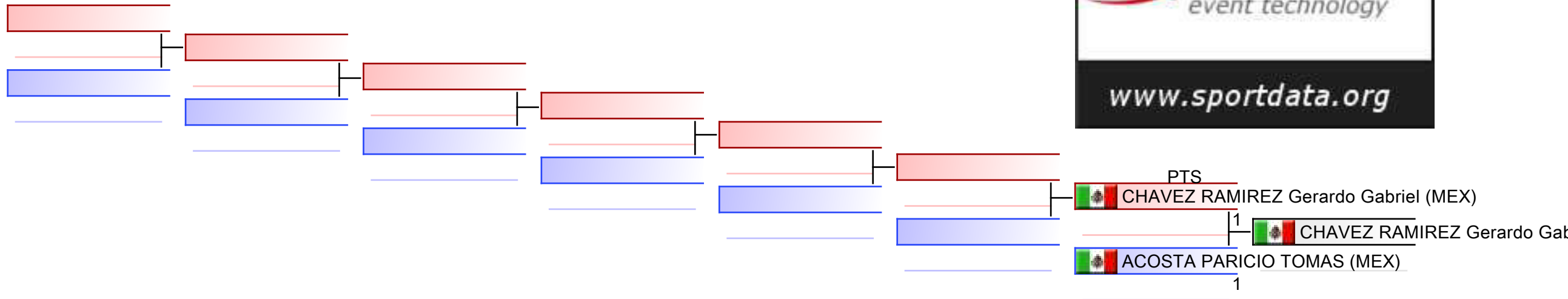

REPECHAGE: (1)

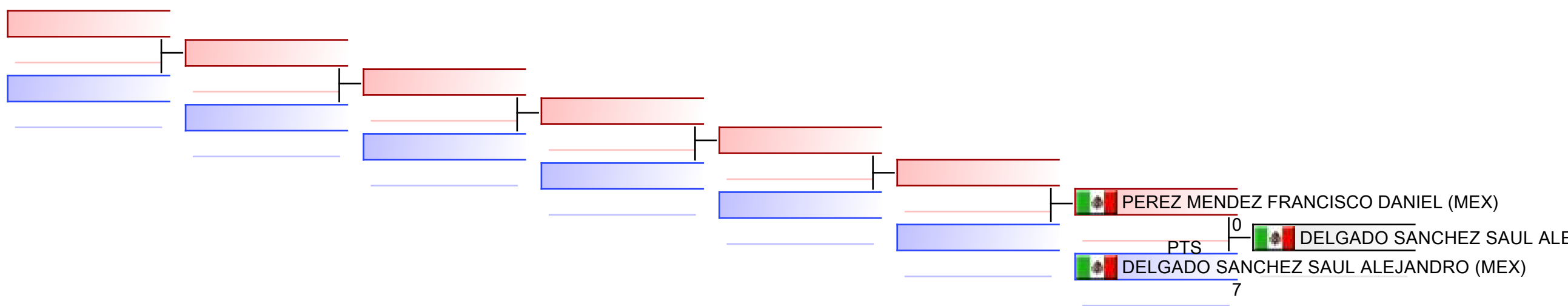

Referees:							
-----------	--	--	--	--	--	--	--



Karate1 Youth League - Cancun 2024 - 2024-08-08



Official Results

U14 Kumite Male -55 kg			
1	VELAZQUEZ OSUNA OLIVER LEONARDO		MEX - MEXICO
2	CCOILLO FERRANTE ADRIANO TADEO		PER - PERU
3	CHAVEZ RAMIREZ GERARDO GABRIEL		MEX - MEXICO
3	DELGADO SANCHEZ SAUL ALEJANDRO		MEX - MEXICO
5	ACOSTA PARICIO TOMAS		MEX - MEXICO
5	PEREZ MENDEZ FRANCISCO DANIEL		MEX - MEXICO

U21 KATA FEMALE



Karate1 Youth League - Cancun 2024
ENTRIES BY WEIGHT CATEGORY



U21 Kata Female
As of 11 AUG 2024

NOC Code	Gender	Name	Seeding
BRA	F	BISSOLI FERRI KUSTER AMANDA	
BRA	F	Cardoso Letícia de Souza	
CAN	F	CARTER BROOKLYN	
CAN	F	Kudsi Masa	
CHI	F	GALLO ARAYA ISIDORA	
CHI	F	SALINAS ISIDORA CAROLINA	
COL	F	castaño rojo leidy daniela	
CRC	F	RUIZ CAMILA	
ENG	F	Williams Danni	
ITA	F	Tagliaferro Chiara	
MEX	F	Dena Alvarez Joana María	
MEX	F	GARCIA PACHECO REGINA ESTELA	
MEX	F	MARTINEZ ZAPATA ANA YURIDIA	
MEX	F	QUINTERO AVAS CIELO	
MEX	F	VALDES LEYVA RAQUEL	
PER	F	Valdivia Monzon Alexandra Sofia	
POR	F	Cardoso Maria	
POR	F	Martins Rita	
SUI	F	Tschanz Olivia	

U21 Kata Female

Karate1 Youth League - Cancun 2024, Iberostar Playa Paraíso Convention Center, Avenida del Sol Km 309, Playa Paraiso, 77710 Riviera Maya, MEX

2024-08-08

Tatami

2 09:00

Pool

2/2

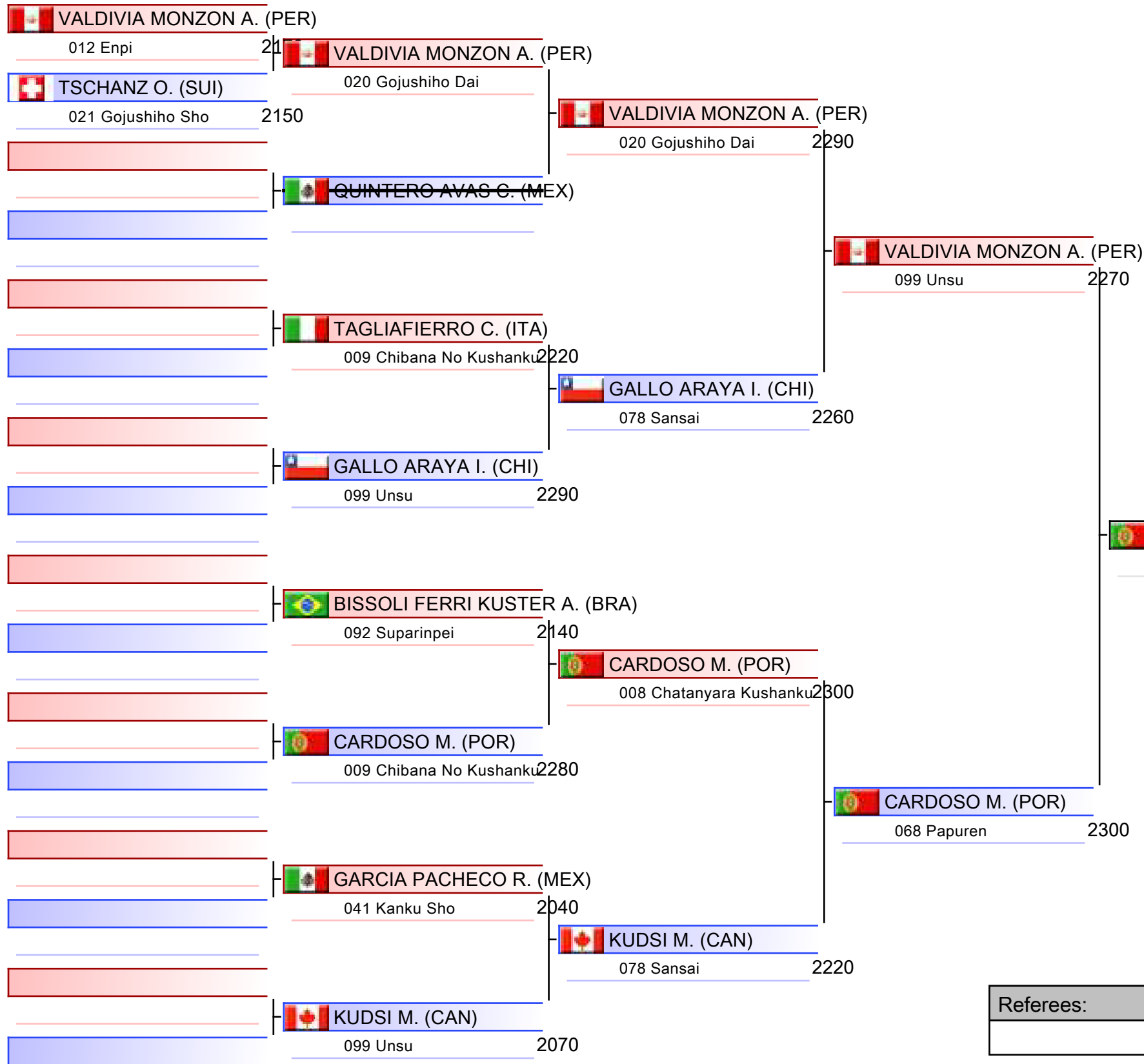

- | |
|--|
| 1. CARDOSO MARIA (POR) |
| 2. CASTAÑO ROJO LEIDY DANIELA (COL) |
| 3. VALDIVIA MONZON ALEXANDRA SOFIA (PER) |
| 3. MARTINS RITA (POR) |
| 5. KUDSI MASA (CAN) |
| 5. WILLIAMS DANNI (ENG) |
| 7. BISSOLI FERRI KUSTER AMANDA (BRA) |
| 7. RUIZ CAMILA (CRC) |

Referees:			

Pool winner-U21 Kata Female

Karate1 Youth League - Cancun 2024, Iberostar Playa Paraíso Convention Center, Avenida del Sol Km 309, Playa Paraiso, 77710 Riviera Maya, MEX

Tatami

Pool

1/1

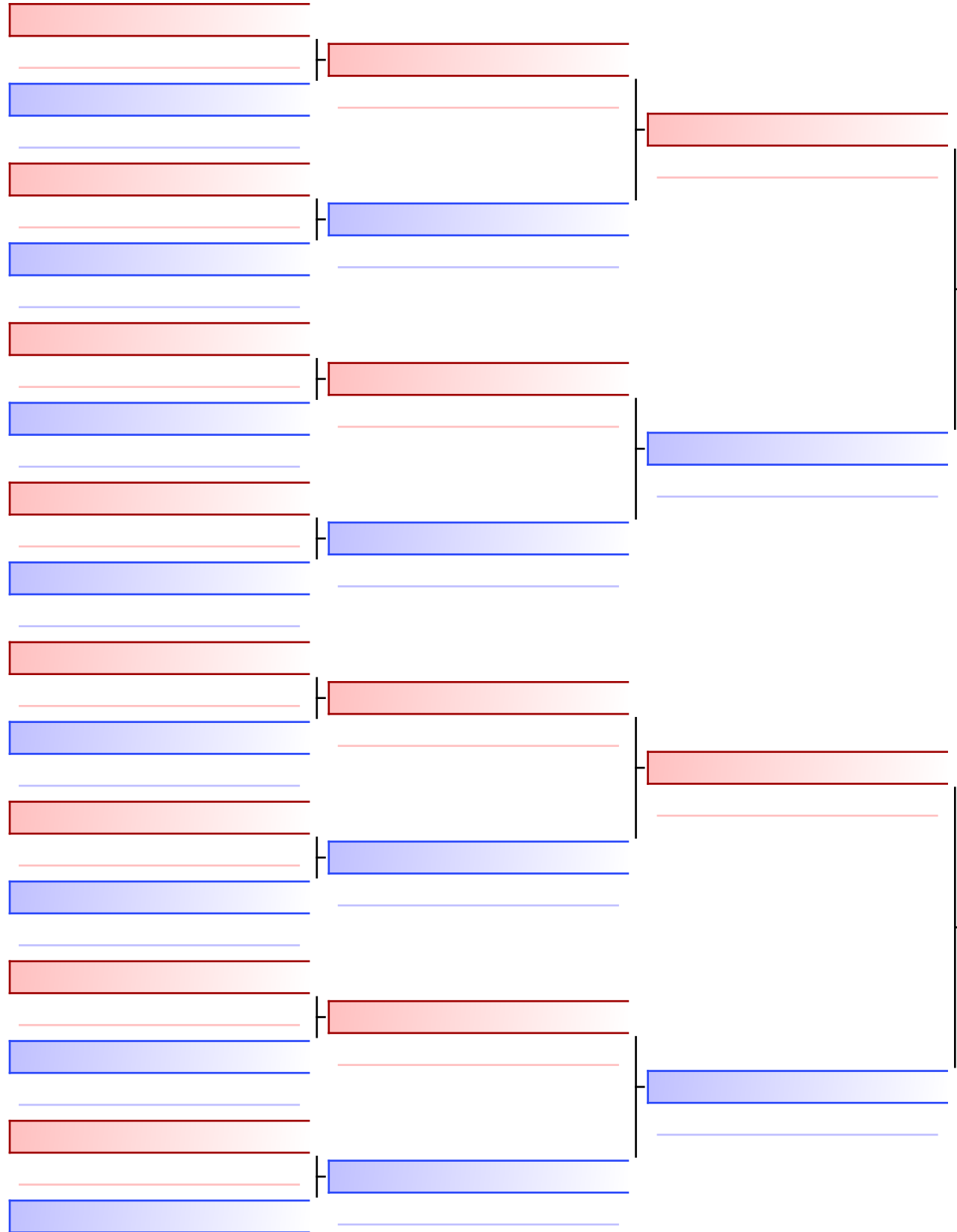

Final

 **CASTAÑO ROJO L. (COL)**
020 Gojushiho Dai 2390

 **CARDOSO M. (POR)**

 **CARDOSO M. (POR)**
092 Suparinpei 2480



1. CARDOSO MARIA (POR)
2. CASTAÑO ROJO LEIDY DANIELA (COL)
3. VALDIVIA MONZON ALEXANDRA SOFIA (PER)
3. MARTINS RITA (POR)
5. KUDSI MASA (CAN)
5. WILLIAMS DANNI (ENG)
7. BISSOLI FERRI KUSTER AMANDA (BRA)
7. RUIZ CAMILA (CRC)

Referees:			

U21 Kata Female

Karate1 Youth League - Cancun 2024

2024-08-08

Tatami
1 10:15

Pool
1

(c)sportdata GmbH & Co KG 2000-2024 (2024-08-11 14:42) v 10.2.0 build 1 (2024-08-09 20:34 CET) License: Online_Event_ID-875_Karate1YouthLeagueCancun2024 (expire 2024-08-25)

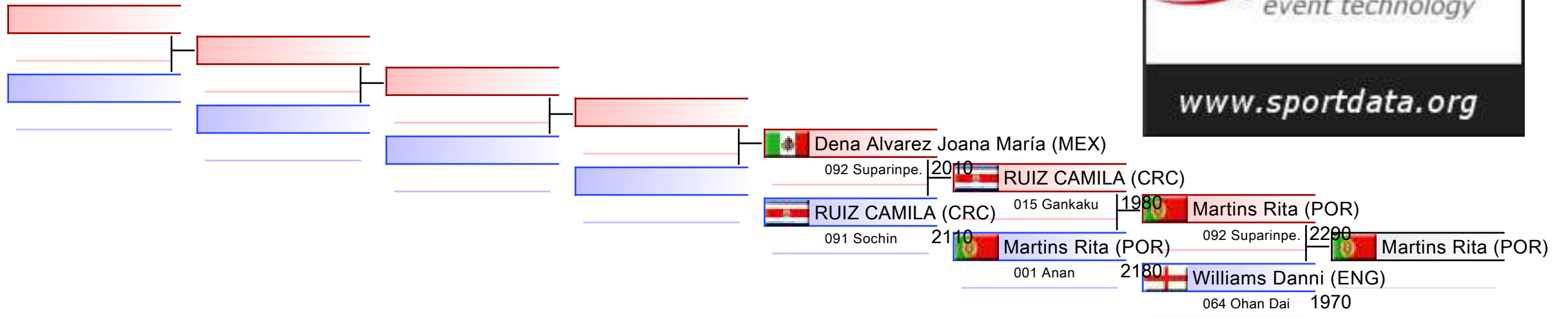

REPECHAGE: (1)

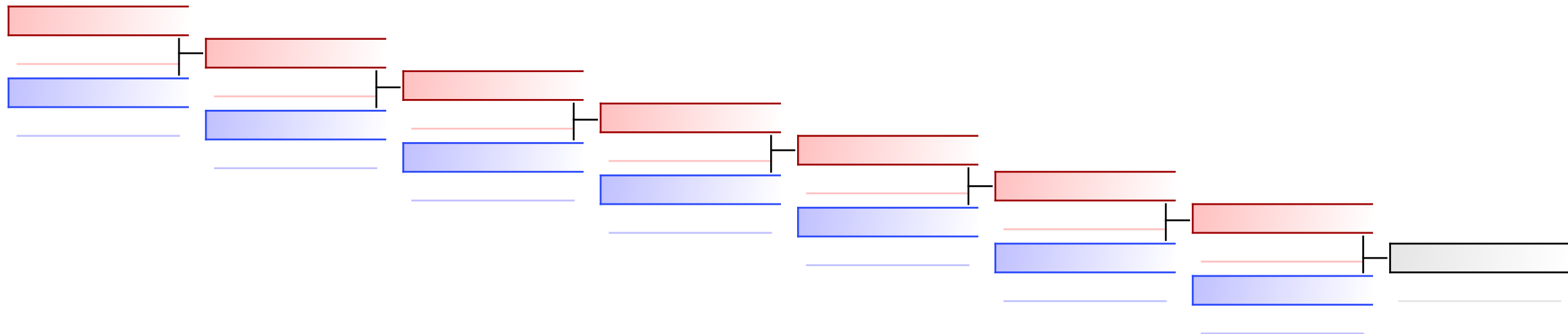

Referees:							
-----------	--	--	--	--	--	--	--

U21 Kata Female

Karate1 Youth League - Cancun 2024

2024-08-08

Tatami
2 10:05

Pool
2

(c)sportdata GmbH & Co KG 2000-2024 (2024-08-11 14:42) v 10.2.0 build 1 (2024-08-09 20:34 CET) License: Online_Event_ID-875_Karate1YouthLeagueCancun2024 (expire 2024-08-25)

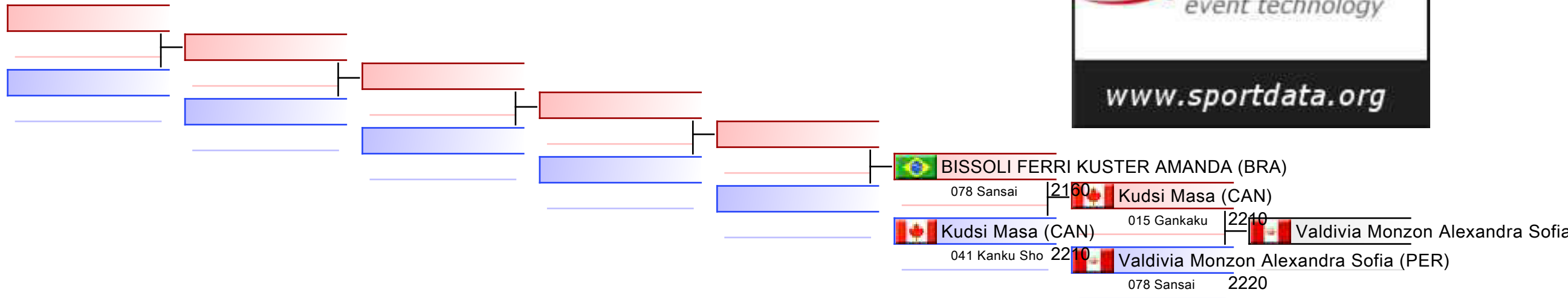

REPECHAGE: (2)

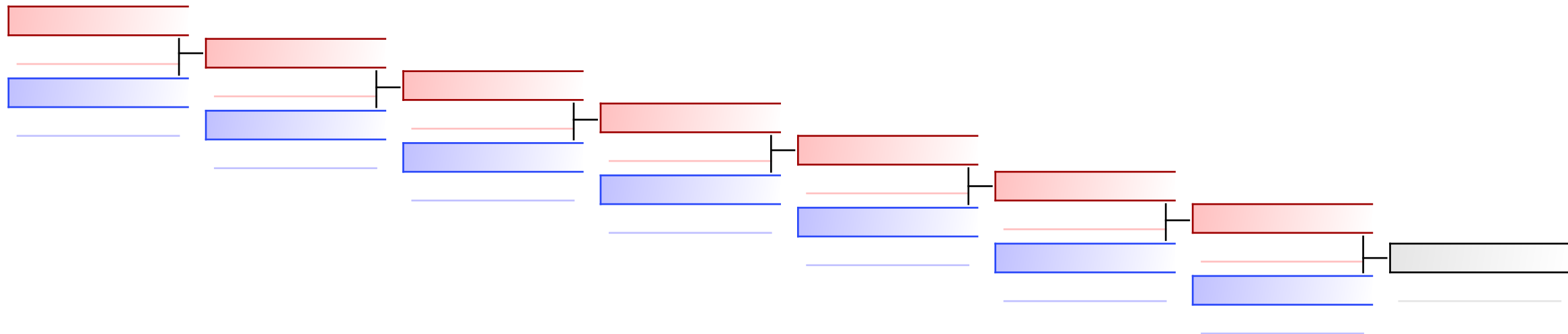

Referees:							
-----------	--	--	--	--	--	--	--



Karate1 Youth League - Cancun 2024 - 2024-08-08



Official Results

U21 Kata Female			
1	CARDOSO MARIA		POR - PORTUGAL
2	CASTANO ROJO LEIDY DANIELA		COL - COLOMBIA
3	VALDIVIA MONZON ALEXANDRA SOFIA		PER - PERU
3	MARTINS RITA		POR - PORTUGAL
5	KUDSI MASA		CAN - CANADA
5	WILLIAMS DANNI		ENG - ENGLAND
7	BISSOLI FERRI KUSTER AMANDA		BRA - BRAZIL
7	RUIZ CAMILA		CRC - COSTA RICA
9	DENA ALVAREZ JOANA MARÍA		MEX - MEXICO

U21 KATA MALE



Karate1 Youth League - Cancun 2024
ENTRIES BY WEIGHT CATEGORY



U21 Kata Male
As of 11 AUG 2024

NOC Code	Gender	Name	Seeding
CAN	M	Darveau Olivier	
CHI	M	Mesina Fuentes Kevin Alexis	
CHI	M	URDANETA VALENCIA ALBERTO	
COL	M	Medina David	
CZE	M	Šťáhlavský Ondřej	
ECU	M	PAEZ JOAQUIN	
ENG	M	Barnes Dylan	
ENG	M	McDade Chad	
FRA	M	BOMPAS JANHAEL	
FRA	M	HOFFMANN LUCAS	
GUA	M	CALDERON FERNANDO	
GUA	M	Castillo Mazariego Jose Manuel	
GUA	M	Diego Noriega Francisco David	
HKG	M	KWOK HO HIM	
ITA	M	MATACCHIONI LUIGI	
MEX	M	CASTILLO RAMOS RODRIGO	
MEX	M	FUNES ANAYA PABLO JESUS	
MEX	M	LEDESMA LUNA ISAAC RAFAEL	
MEX	M	ROJAS SANCHEZ ARATH SAID	
MEX	M	Vega Batiz Carlos Santiago	
PER	M	HIGUCHI KEN	
PER	M	Mejia Ignacio	
POR	M	Matos Pedro	
SUI	M	PETRONE Leandro	
SUI	M	Schedel Keni	
USA	M	Adi David	
USA	M	Corbin Joshua	
USA	M	Quackenbush Eric	

U21 Kata Male

Karate1 Youth League - Cancun 2024, Iberostar Playa Paraíso Convention Center, Avenida del Sol Km 309, Playa Paraiso, 77710 Riviera Maya, MEX

2024-08-08

Tatami

3 09:00

Pool

1/2

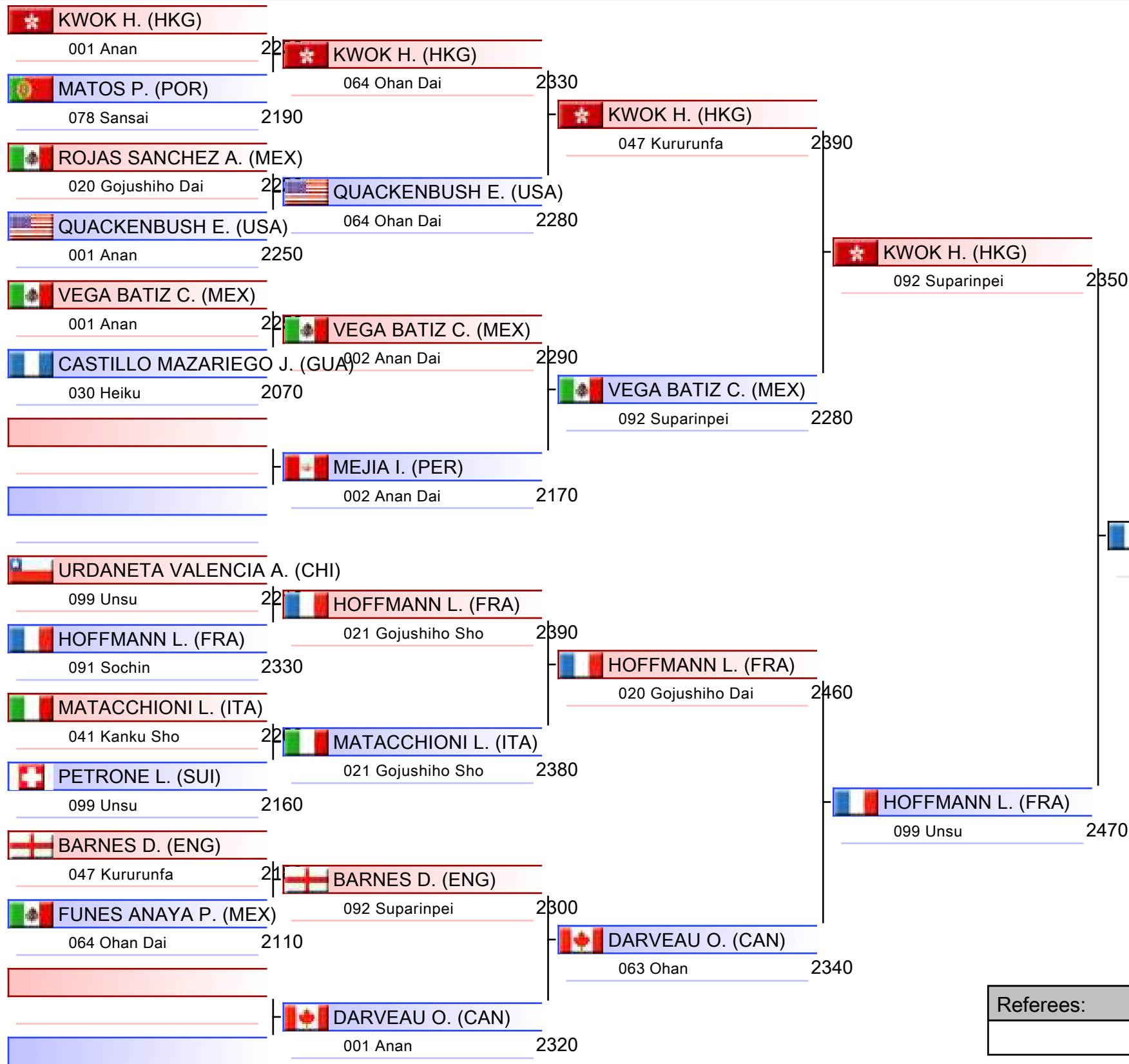

- | |
|-----------------------------|
| 1. HOFFMANN LUCAS (FRA) |
| 2. CALDERON FERNANDO (GUA) |
| 3. MATAACCHIONI LUIGI (ITA) |
| 3. ŠŤÁHLAVSKÝ ONDŘEJ (CZE) |
| 5. KWOK HO HIM (HKG) |
| 5. HIGUCHI KEN (PER) |
| 7. DARVEAU OLIVIER (CAN) |
| 7. PAEZ JOAQUIN (ECU) |

Referees:			

Pool winner-U21 Kata Male

Karate1 Youth League - Cancun 2024, Iberostar Playa Paraíso Convention Center, Avenida del Sol Km 309, Playa Paraiso, 77710 Riviera Maya, MEX

Tatami

Pool

1/1

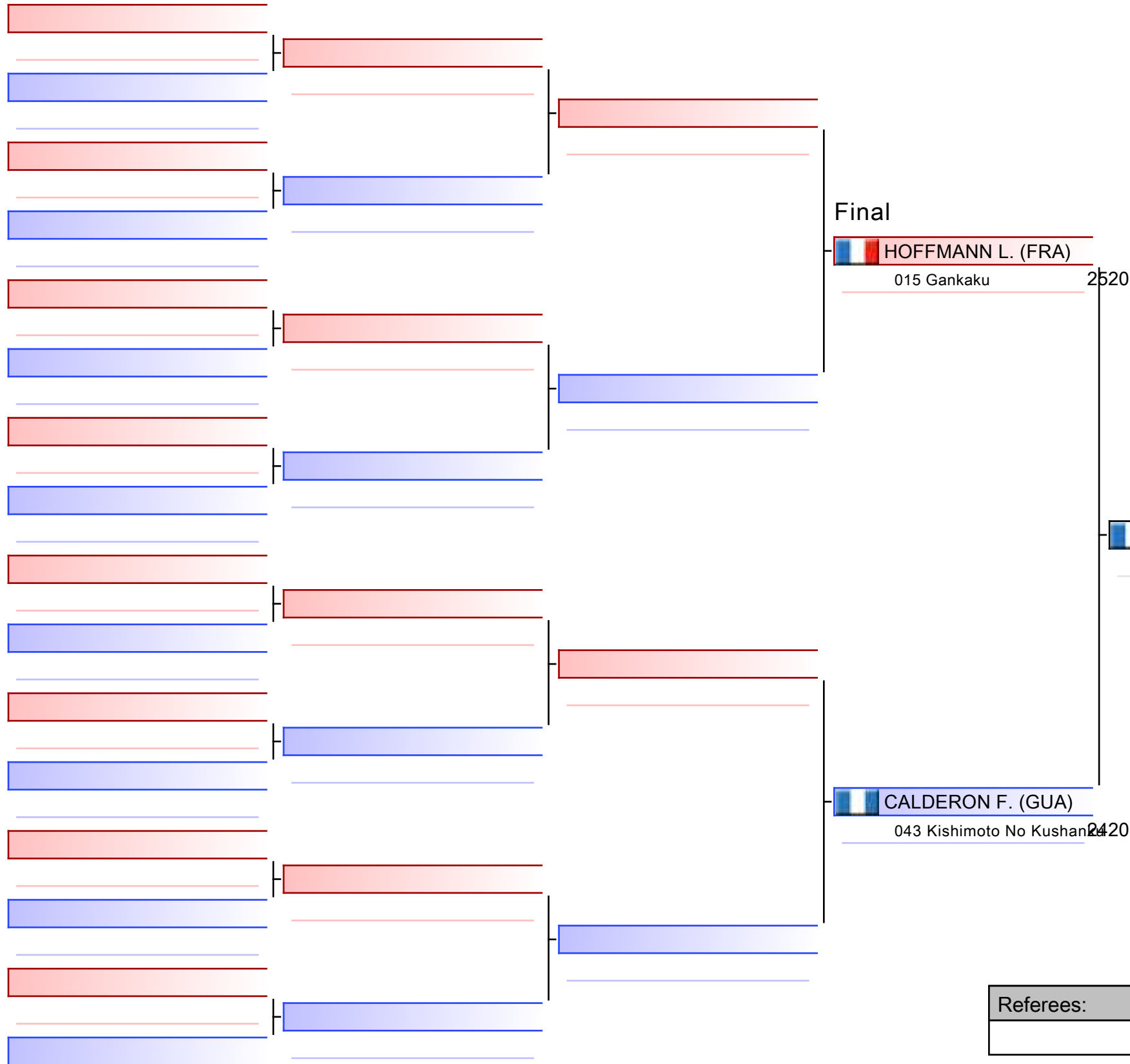

1. HOFFMANN LUCAS (FRA)
2. CALDERON FERNANDO (GUA)
3. MATAACCHIONI LUIGI (ITA)
3. ŠŤÁHLAVSKÝ ONDŘEJ (CZE)
5. KWOK HO HIM (HKG)
5. HIGUCHI KEN (PER)
7. DARVEAU OLIVIER (CAN)
7. PAEZ JOAQUIN (ECU)

Referees:			

U21 Kata Male

Karate1 Youth League - Cancun 2024

2024-08-08

Tatami
3 10:45

Pool
1

(c)sportdata GmbH & Co KG 2000-2024 (2024-08-11 14:42) v 10.2.0 build 1 (2024-08-09 20:34 CET) License: Online_Event_ID-875_Karate1YouthLeagueCancun2024 (expire 2024-08-25)

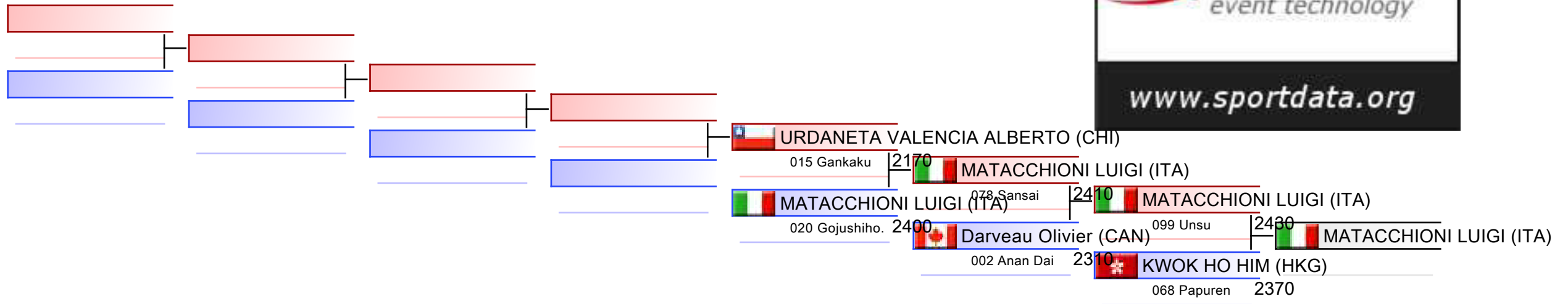

REPECHAGE: (1)

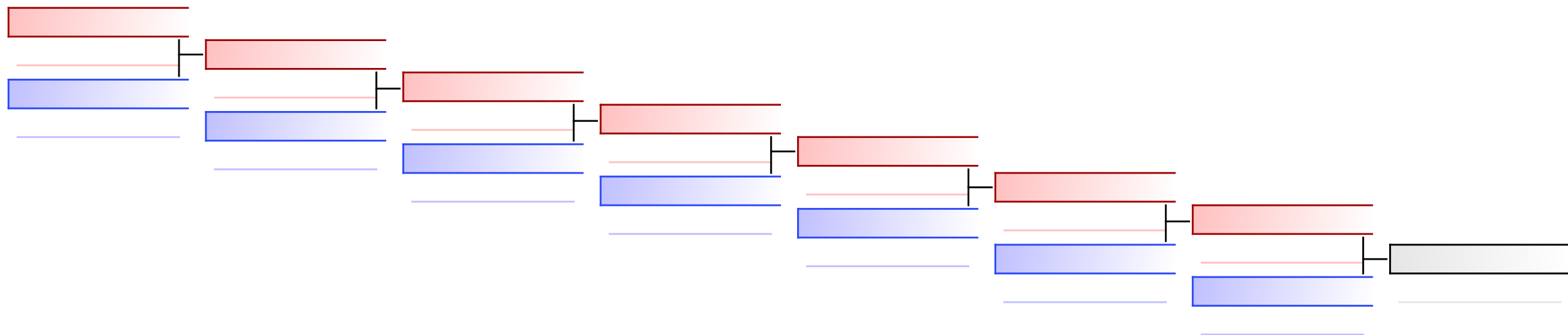

Referees:							
-----------	--	--	--	--	--	--	--

U21 Kata Male

Karate1 Youth League - Cancun 2024

2024-08-08

Tatami
4 10:45

Pool
2

(c)sportdata GmbH & Co KG 2000-2024 (2024-08-11 14:42) v 10.2.0 build 1 (2024-08-09 20:34 CET) License: Online_Event_ID-875_Karate1YouthLeagueCancun2024 (expire 2024-08-25)

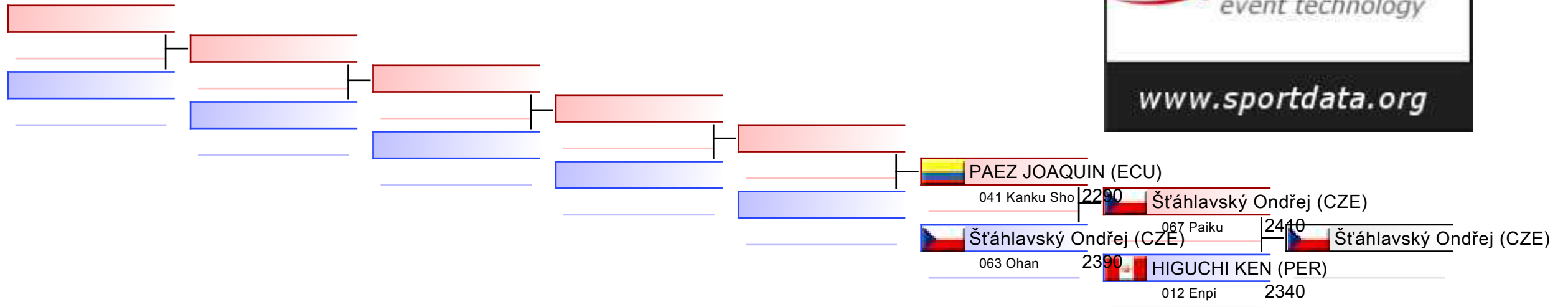

REPECHAGE: (2)

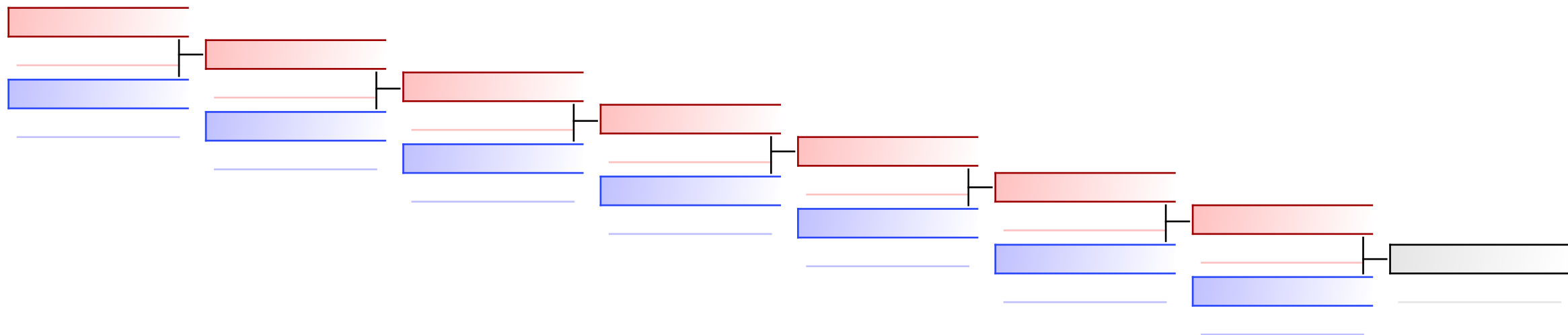

Referees:							
-----------	--	--	--	--	--	--	--



Karate1 Youth League - Cancun 2024 - 2024-08-08



Official Results

U21 Kata Male			
1	HOFFMANN LUCAS		FRA - FRANCE
2	CALDERÓN FERNANDO		GUA - GUATEMALA
3	MATACCHIONI LUIGI		ITA - ITALY
3	ŠTAHLAVSKÝ ONDŘEJ		CZE - CZECH REPUBLIC
5	KWOK HO HIM		HKG - HONG KONG, CHINA
5	HIGUCHI KEN		PER - PERU
7	DARVEAU OLIVIER		CAN - CANADA
7	PAEZ JOAQUIN		ECU - ECUADOR
9	URDANETA VALENCIA ALBERTO		CHI - CHILE

U21 KUMITE FEMALE -50 KG



Karate1 Youth League - Cancun 2024
ENTRIES BY WEIGHT CATEGORY



U21 Kumite Female -50 kg
As of 11 AUG 2024

NOC Code	Gender	Name	Seeding
BOL	F	LUNA PAOLA	
CHI	F	ECHEVERRIA VEGA BELÉN ANTONIA ALEXANDRA	
CHI	F	LEIVA GAETE MAIRA	
ESA	F	ORANTES MAGANA SOFIA ALEJANDRA	
MEX	F	CARRILLO URDIALES CINTHIA RUBI	
MEX	F	SALINAS HERNANDEZ EMILIA	
NED	F	YALCIN Samina	

U21 Kumite Female -50 kg

Karate1 Youth League - Cancun 2024, Iberostar Playa Paraíso Convention Center, Avenida del Sol Km 309, Playa Paraiso, 77710 Riviera Maya, MEX

2024-08-08

Tatami
3 11:15

Pool
1/1

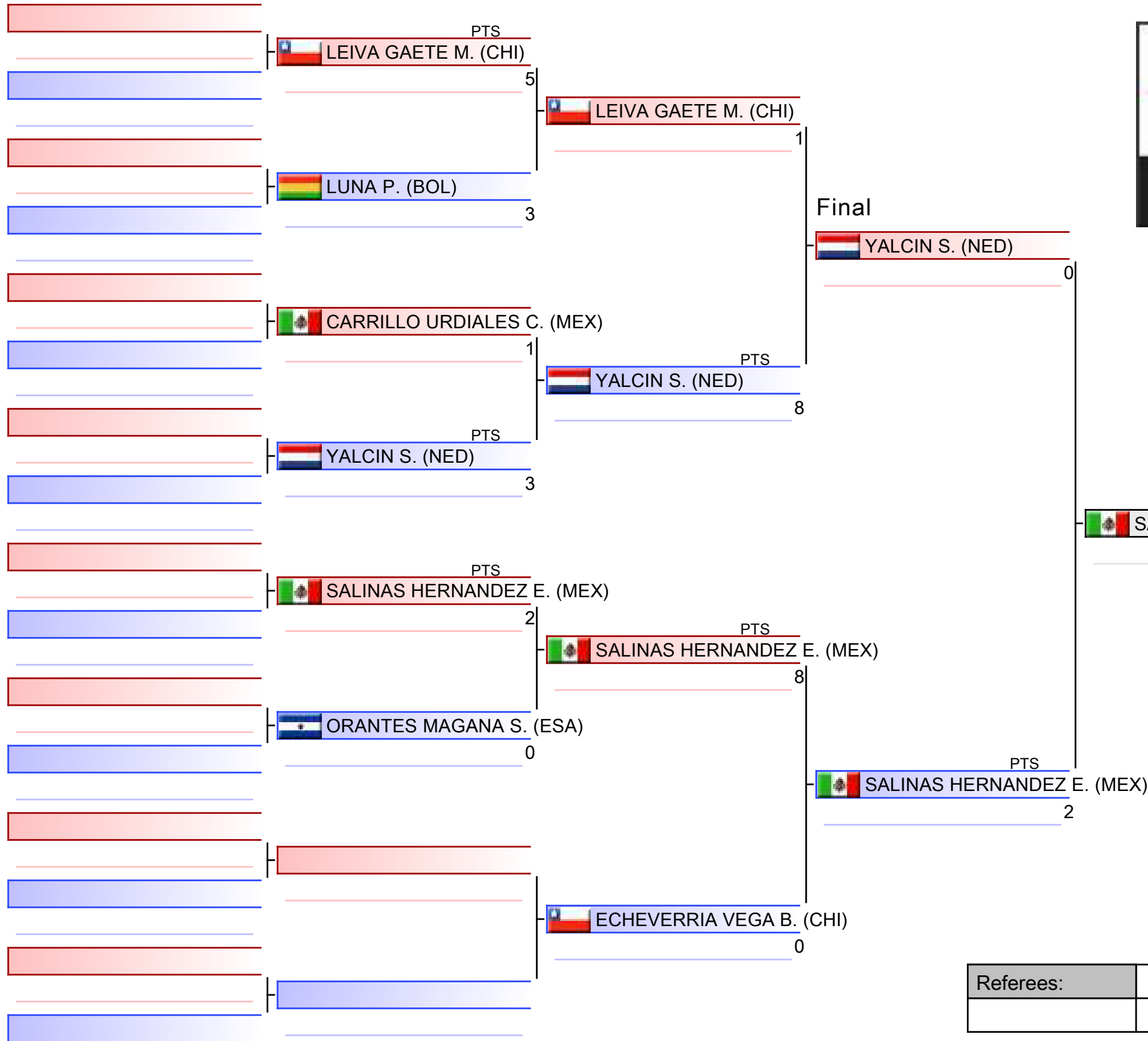

1. SALINAS HERNANDEZ EMILIA (MEX)
2. YALCIN SAMINA (NED)
3. ORANTES MAGANA SOFIA ALEJANDRA (ESA)
3. CARRILLO URDIALES CINTHIA RUBI (MEX)
5. ECHEVERRIA VEGA BELÉN ANTONIA ALEXANDRA (CHI)
5. LEIVA GAETE MAIRA (CHI)

Referees:			

U21 Kumite Female -50 kg

Karate1 Youth League - Cancun 2024

2024-08-08

Tatami
3 11:50

Pool
1

(c)sportdata GmbH & Co KG 2000-2024 (2024-08-11 14:42) v 10.2.0 build 1 (2024-08-09 20:34 CET) License: Online_Event_ID-875_Karate1YouthLeagueCancun2024 (expire 2024-08-25)

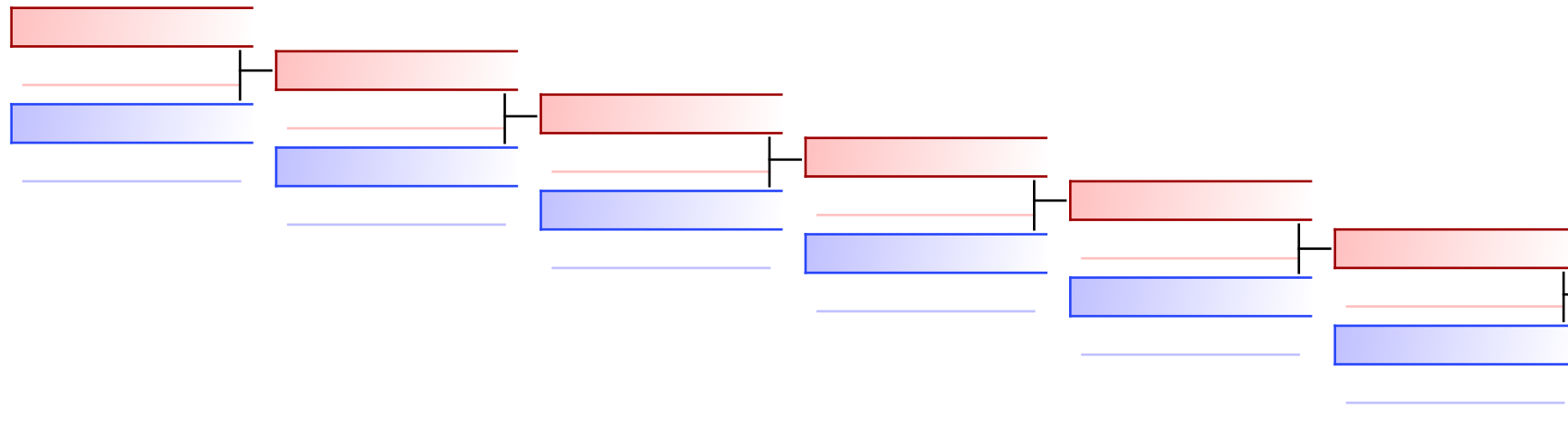

PTS
CARRILLO URDIALES CINTHIA RUBI (MEX) | 1
LEIVA GAETE MAIRA (CHI) | 0

REPECHAGE: (1)

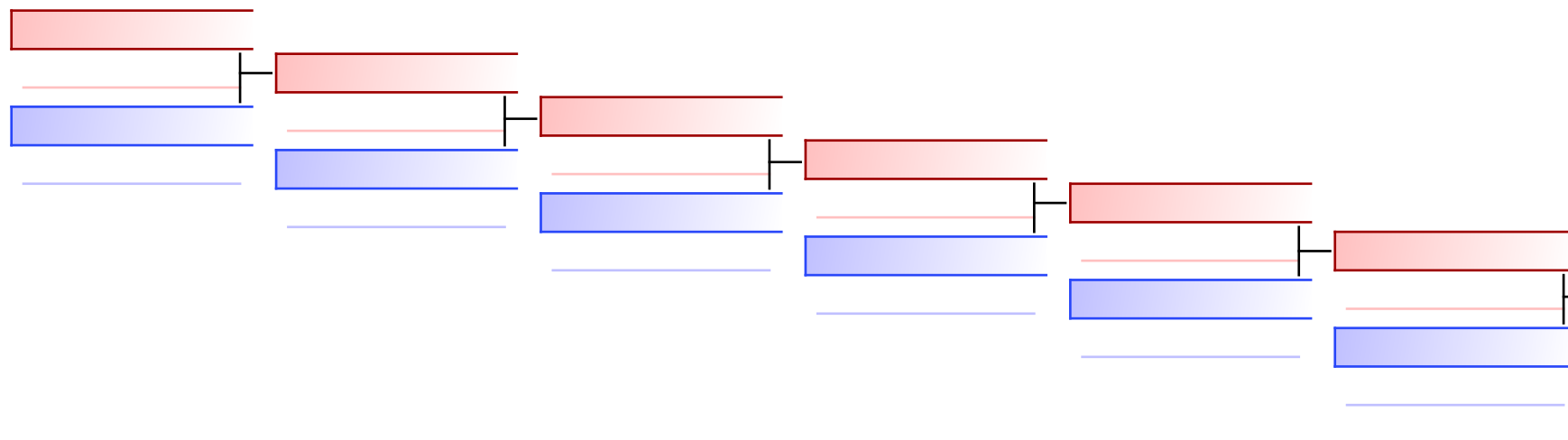

PTS
ORANTES MAGANA SOFIA ALEJANDRA (ESA) | 8
ECHEVERRIA VEGA BELÉN ANTONIA ALEXANDRA (CHI) | 0





Referees:							
-----------	--	--	--	--	--	--	--



Karate1 Youth League - Cancun 2024 - 2024-08-08



Official Results

U21 Kumite Female -50 kg			
1	SALINAS HERNANDEZ EMILIA		MEX - MEXICO
2	YALCIN SAMINA		NED - NETHERLANDS
3	ORANTES MAGANA SOFIA ALEJANDRA		ESA - EL SALVADOR
3	CARRILLO URDIALES CINTHIA RUBI		MEX - MEXICO
5	ECHEVERRIA VEGA BELÉN ANTONIA ALEXANDRA		CHI - CHILE
5	LEIVA GAETE MAIRA		CHI - CHILE

U21 KUMITE FEMALE -55 KG



Karate1 Youth League - Cancun 2024
ENTRIES BY WEIGHT CATEGORY



U21 Kumite Female -55 kg
As of 11 AUG 2024

NOC Code	Gender	Name	Seeding
BEL	F	Ejja Iman	
CAN	F	REGLAR EMILY	
CHI	F	flores cabrera francisca	
CHI	F	GATICA MORALES BELEN	
CHI	F	GODOY MAGDALENA	
COL	F	GOMEZ BUITRAGO MARIA JOSE	
ESA	F	FLORES RAMOS HAZEL SAMEIDY	
MEX	F	GARCIA PACHECO REGINA ESTELA	
MEX	F	HERRERA AYALA ANA CAROLINA	
MEX	F	NIETO FLORES IDALIA KARIME	

U21 Kumite Female -55 kg

Karate1 Youth League - Cancun 2024, Iberostar Playa Paraíso Convention Center, Avenida del Sol Km 309, Playa Paraiso, 77710 Riviera Maya, MEX

2024-08-08

Tatami

4 11:15

Pool

1/1

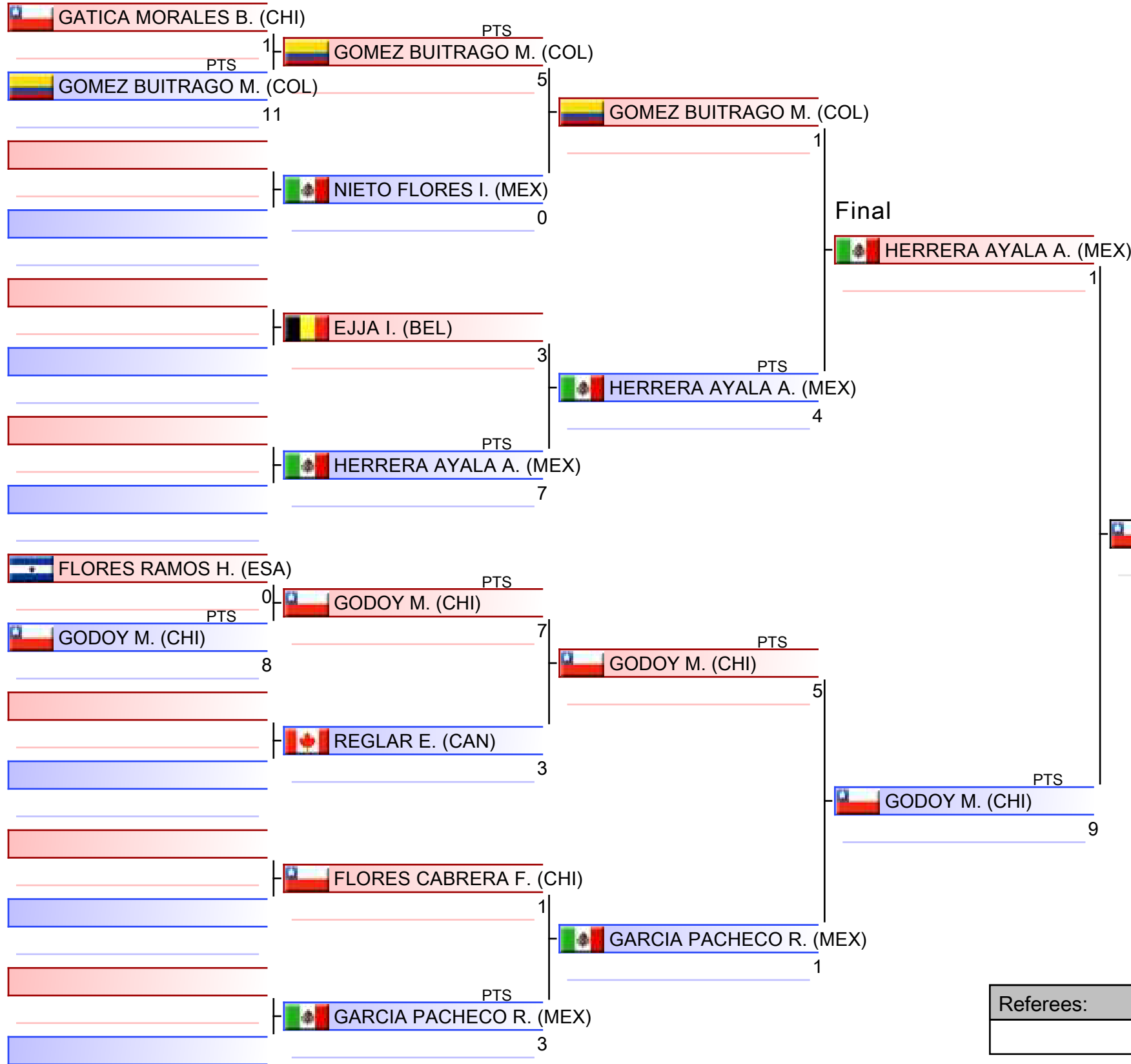

- | |
|---------------------------------------|
| 1. GODOY MAGDALENA (CHI) |
| 2. HERRERA AYALA ANA CAROLINA (MEX) |
| 3. REGLAR EMILY (CAN) |
| 3. EJJA IMAN (BEL) |
| 5. GARCIA PACHECO REGINA ESTELA (MEX) |
| 5. GOMEZ BUITRAGO MARIA JOSE (COL) |
| 7. FLORES RAMOS HAZEL SAMEIDY (ESA) |
| |
| |

Referees:			

U21 Kumite Female -55 kg

Karate1 Youth League - Cancun 2024

2024-08-08

Tatami
4 12:10

Pool
1

(c)sportdata GmbH & Co KG 2000-2024 (2024-08-11 14:42) v 10.2.0 build 1 (2024-08-09 20:34 CET) License: Online_Event_ID-875_Karate1YouthLeagueCancun2024 (expire 2024-08-25)

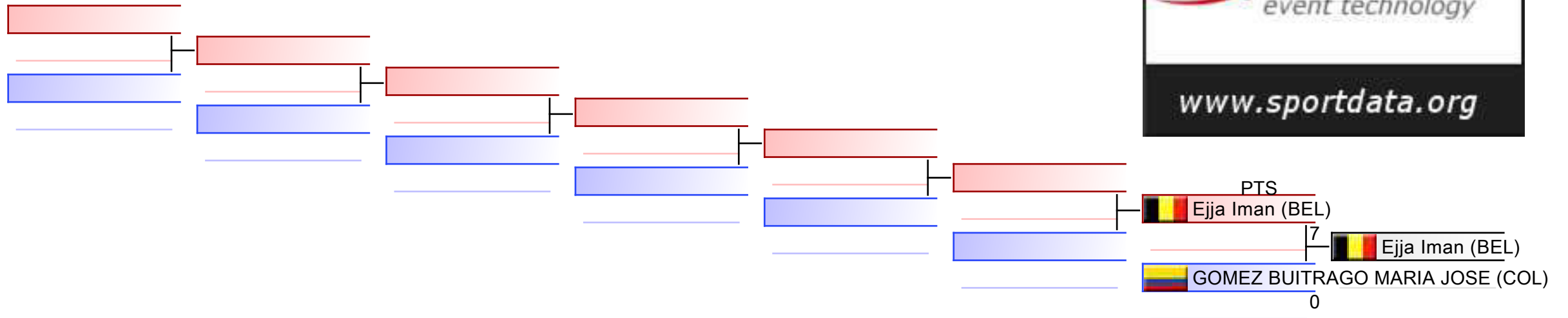

REPECHAGE: (1)

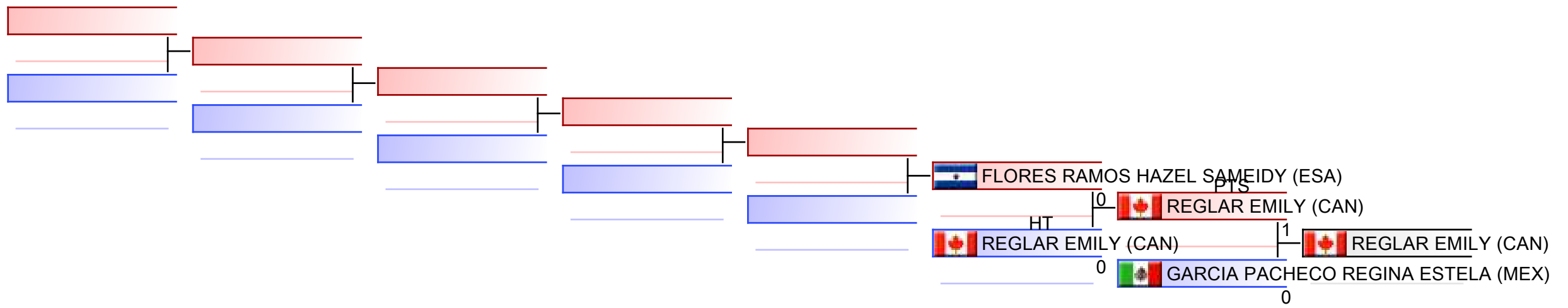

Referees:							
-----------	--	--	--	--	--	--	--



Karate1 Youth League - Cancun 2024 - 2024-08-08



Official Results

U21 Kumite Female -55 kg			
1	GODOY MAGDALENA		CHI - CHILE
2	HERRERA AYALA ANA CAROLINA		MEX - MEXICO
3	REGLAR EMILY		CAN - CANADA
3	EJJA IMAN		BEL - BELGIUM
5	GARCIA PACHECO REGINA ESTELA		MEX - MEXICO
5	GOMEZ BUITRAGO MARIA JOSE		COL - COLOMBIA
7	FLORES RAMOS HAZEL SAMEIDY		ESA - EL SALVADOR

U21 KUMITE FEMALE -61 KG



Karate1 Youth League - Cancun 2024
ENTRIES BY WEIGHT CATEGORY



U21 Kumite Female -61 kg
As of 11 AUG 2024

NOC Code	Gender	Name	Seeding
CAN	F	LAWRANCE SOPHIE	
CHI	F	Vergara Ramírez Martina Isidora	
COL	F	AGUDELO MARIN MARIA ALEJANDRA	
COL	F	gomez betancur ana maria	
COL	F	MAYA NAYELIS	
CRO	F	CACKO MIA	
MEX	F	LOPEZ SERRATOS KATIA DANIELA	
MEX	F	SAAVEDRA AGUIRRE VALERIA	
POL	F	Criou Eva	

U21 Kumite Female -61 kg

Karate1 Youth League - Cancun 2024, Iberostar Playa Paraíso Convention Center, Avenida del Sol Km 309, Playa Paraiso, 77710 Riviera Maya, MEX

2024-08-08

Tatami
2 12:00

Pool
1/1

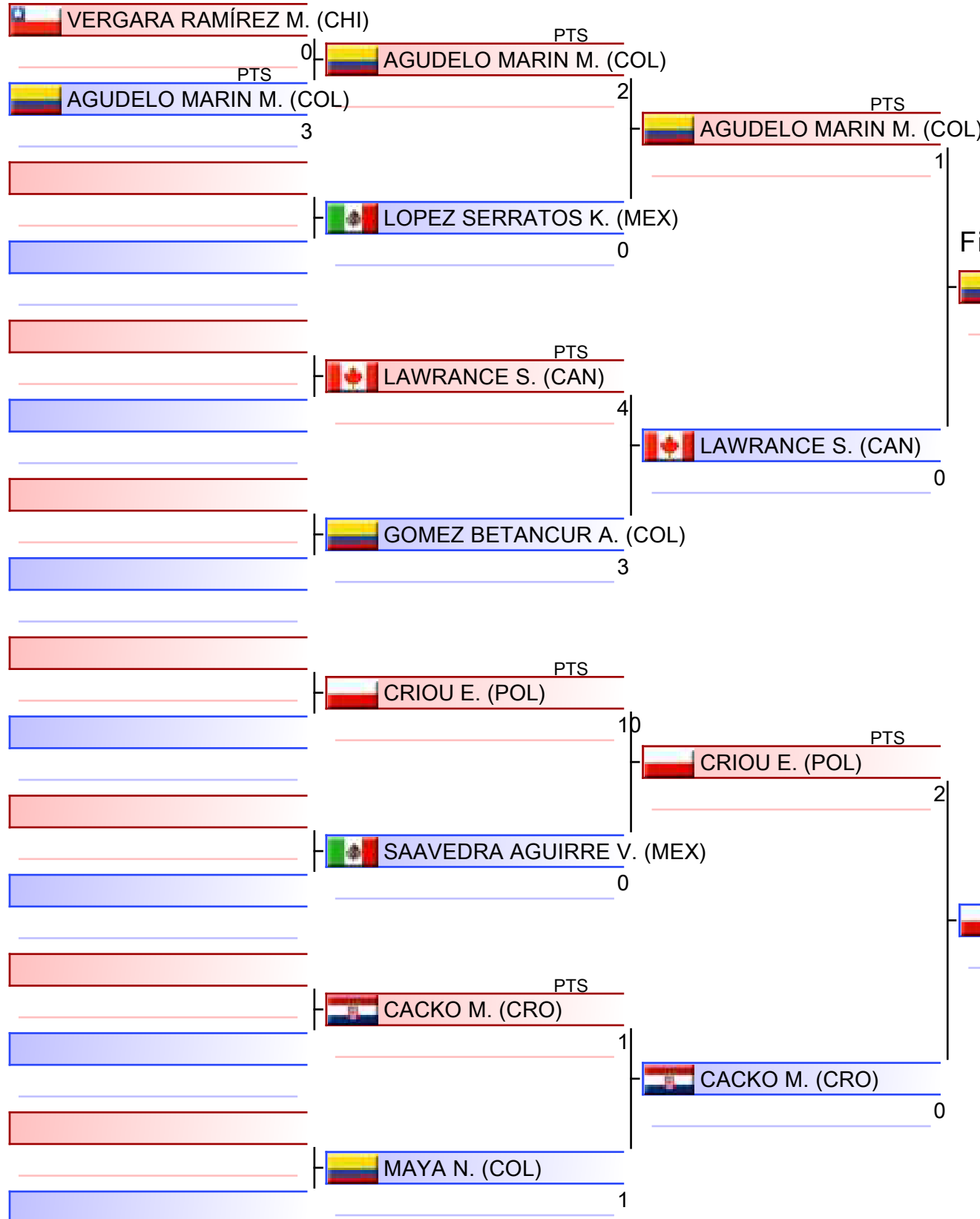

1. CRIOU EVA (POL)
2. AGUDELO MARIN MARIA ALEJANDRA (COL)
3. CACKO MIA (CRO)
3. LAWRENCE SOPHIE (CAN)
5. SAAVEDRA AGUIRRE VALERIA (MEX)
5. LOPEZ SERRATOS KATIA DANIELA (MEX)
7. VERGARA RAMÍREZ MARTINA ISIDORA (CHI)

Referees:			

U21 Kumite Female -61 kg

Karate1 Youth League - Cancun 2024

2024-08-08

Tatami
2 12:50

Pool
1

(c)sportdata GmbH & Co KG 2000-2024 (2024-08-11 14:42) v 10.2.0 build 1 (2024-08-09 20:34 CET) License: Online_Event_ID-875_Karate1YouthLeagueCancun2024 (expire 2024-08-25)

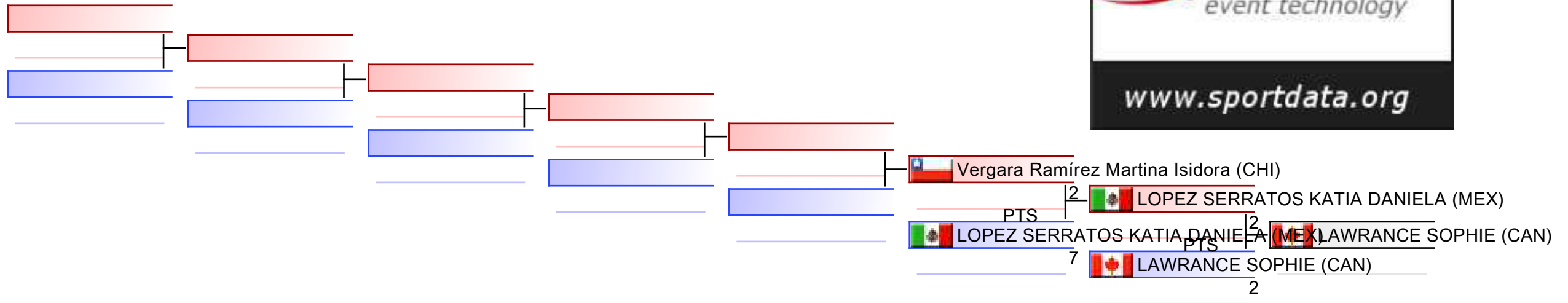

REPECHAGE: (1)

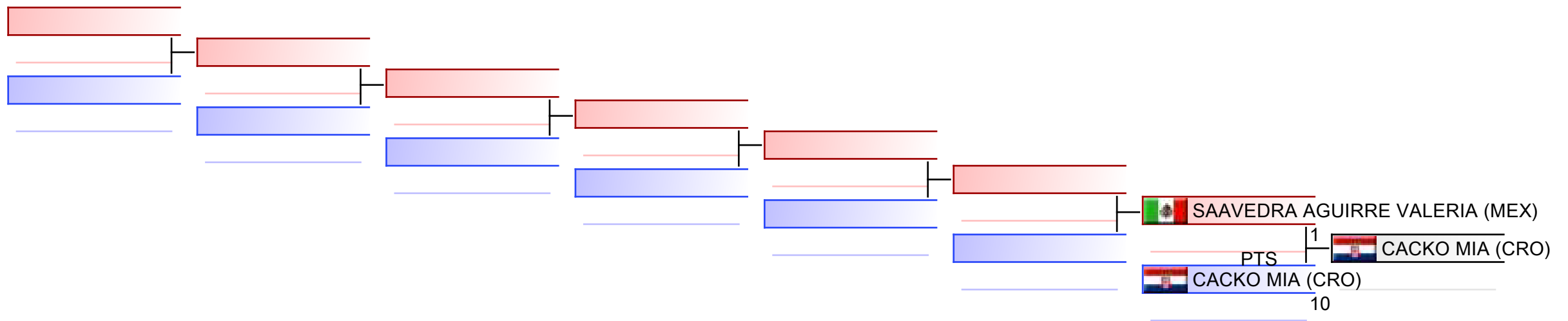

Referees:							
-----------	--	--	--	--	--	--	--



Karate1 Youth League - Cancun 2024 - 2024-08-08



Official Results

U21 Kumite Female -61 kg			
1	CRIOU EVA		POL - POLAND
2	AGUDELO MARIN MARIA ALEJANDRA		COL - COLOMBIA
3	CACKO MIA		CRO - CROATIA
3	LAWRANCE SOPHIE		CAN - CANADA
5	SAAVEDRA AGUIRRE VALERIA		MEX - MEXICO
5	LOPEZ SERRATOS KATIA DANIELA		MEX - MEXICO
7	VERGARA RAMIREZ MARTINA ISIDORA		CHI - CHILE

U21 KUMITE FEMALE -68 KG



Karate1 Youth League - Cancun 2024
ENTRIES BY WEIGHT CATEGORY



U21 Kumite Female -68 kg
As of 11 AUG 2024

NOC Code	Gender	Name	Seeding
CHI	F	PERALTA MARCO José Ignacia	
GUA	F	PALENCIA LUISA	
MEX	F	MENDEZ MAYEN ALONDRA ELIZABETH	
MEX	F	QUINTERO AVAS CIELO	
MEX	F	SORIA ESQUIVEL ANA SOFIA	
MEX	F	VALDES LEYVA RAQUEL	

U21 Kumite Female -68 kg

Karate1 Youth League - Cancun 2024, Iberostar Playa Paraíso Convention Center, Avenida del Sol Km 309, Playa Paraiso, 77710 Riviera Maya, MEX

2024-08-08

Tatami
2 13:20

Pool
1/1

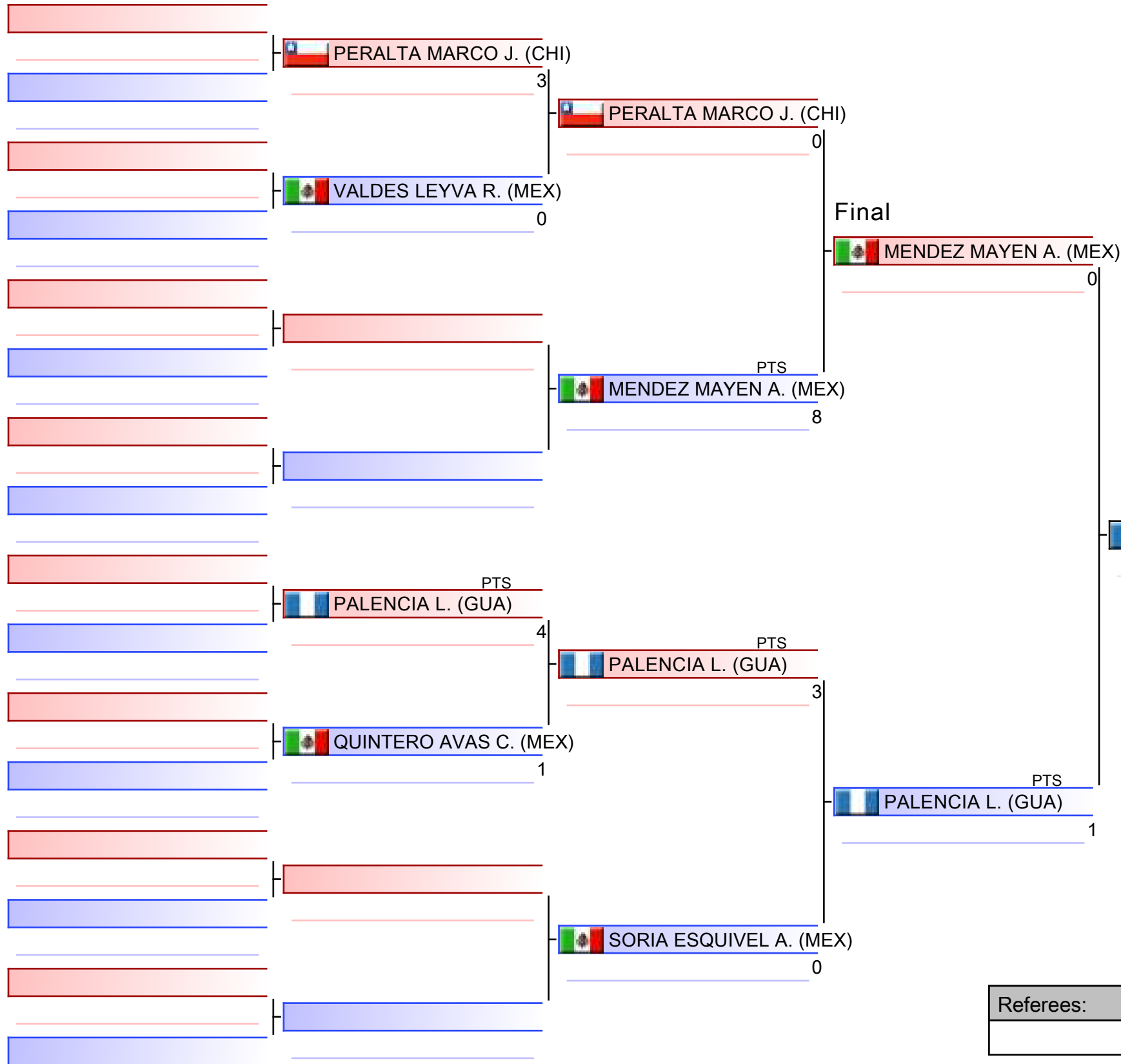

1. PALENCIA LUISA (GUA)
2. MENDEZ MAYEN ALONDRA ELIZABETH (MEX)
3. QUINTERO AVAS CIELO (MEX)
3. PERALTA MARCO JOSÉ IGNACIA (CHI)
5. SORIA ESQUIVEL ANA SOFIA (MEX)

Referees:			

U21 Kumite Female -68 kg

Karate1 Youth League - Cancun 2024

2024-08-08

Tatami
2 13:45

Pool
1

(c)sportdata GmbH & Co KG 2000-2024 (2024-08-11 14:42) v 10.2.0 build 1 (2024-08-09 20:34 CET) License: Online_Event_ID-875_Karate1YouthLeagueCancun2024 (expire 2024-08-25)

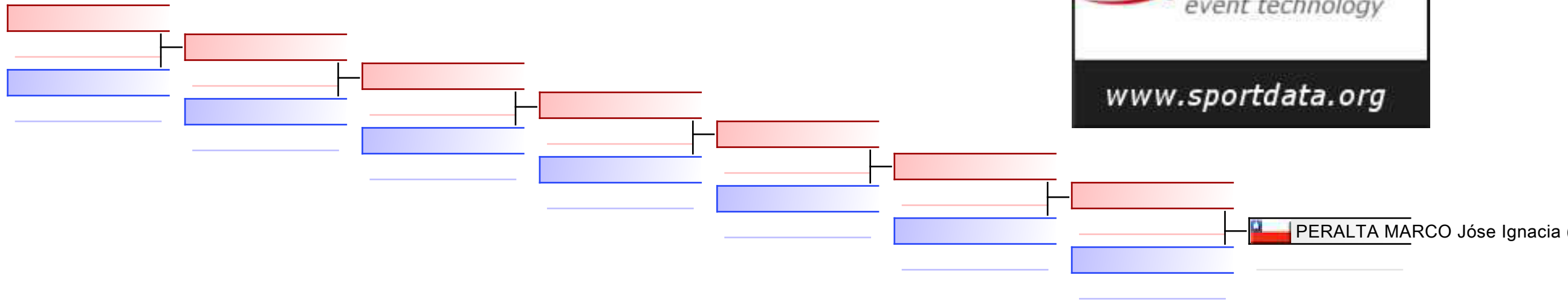

REPECHAGE: (1)

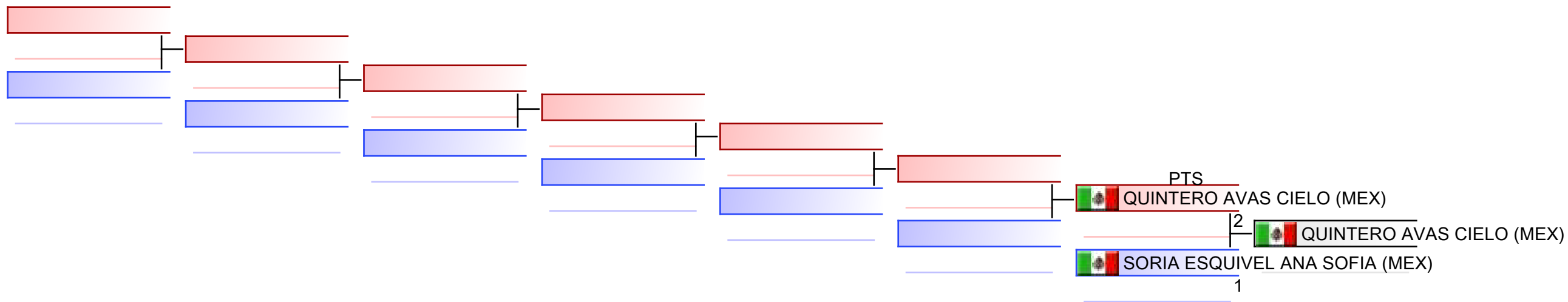

Referees:							
-----------	--	--	--	--	--	--	--



Karate1 Youth League - Cancun 2024 - 2024-08-08



Official Results

U21 Kumite Female -68 kg			
1	PALENCIA LUISA		GUA - GUATEMALA
2	MENDEZ MAYEN ALONDRA ELIZABETH		MEX - MEXICO
3	QUINTERO AVAS CIELO		MEX - MEXICO
3	PERALTA MARCO JOSÉ IGNACIA		CHI - CHILE
5	SORIA ESQUIVEL ANA SOFIA		MEX - MEXICO

U21 KUMITE FEMALE 68+ KG



Karate1 Youth League - Cancun 2024
ENTRIES BY WEIGHT CATEGORY



U21 Kumite Female 68+ kg
As of 11 AUG 2024

NOC Code	Gender	Name	Seeding
AUT	F	SCHUETZE EMMA	
COL	F	GUARIN SOFIA	
ENG	F	Allsopp Amber	
PER	F	Honorio Velasco Doris Fabiana	
SLO	F	Muzik Taša Mau	
USA	F	Jennings Destiny	
USA	F	Thahir Shaza	

U21 Kumite Female 68+ kg

Karate1 Youth League - Cancun 2024, Iberostar Playa Paraíso Convention Center, Avenida del Sol Km 309, Playa Paraiso, 77710 Riviera Maya, MEX

2024-08-08

Tatami
1 14:25

Pool
1/1

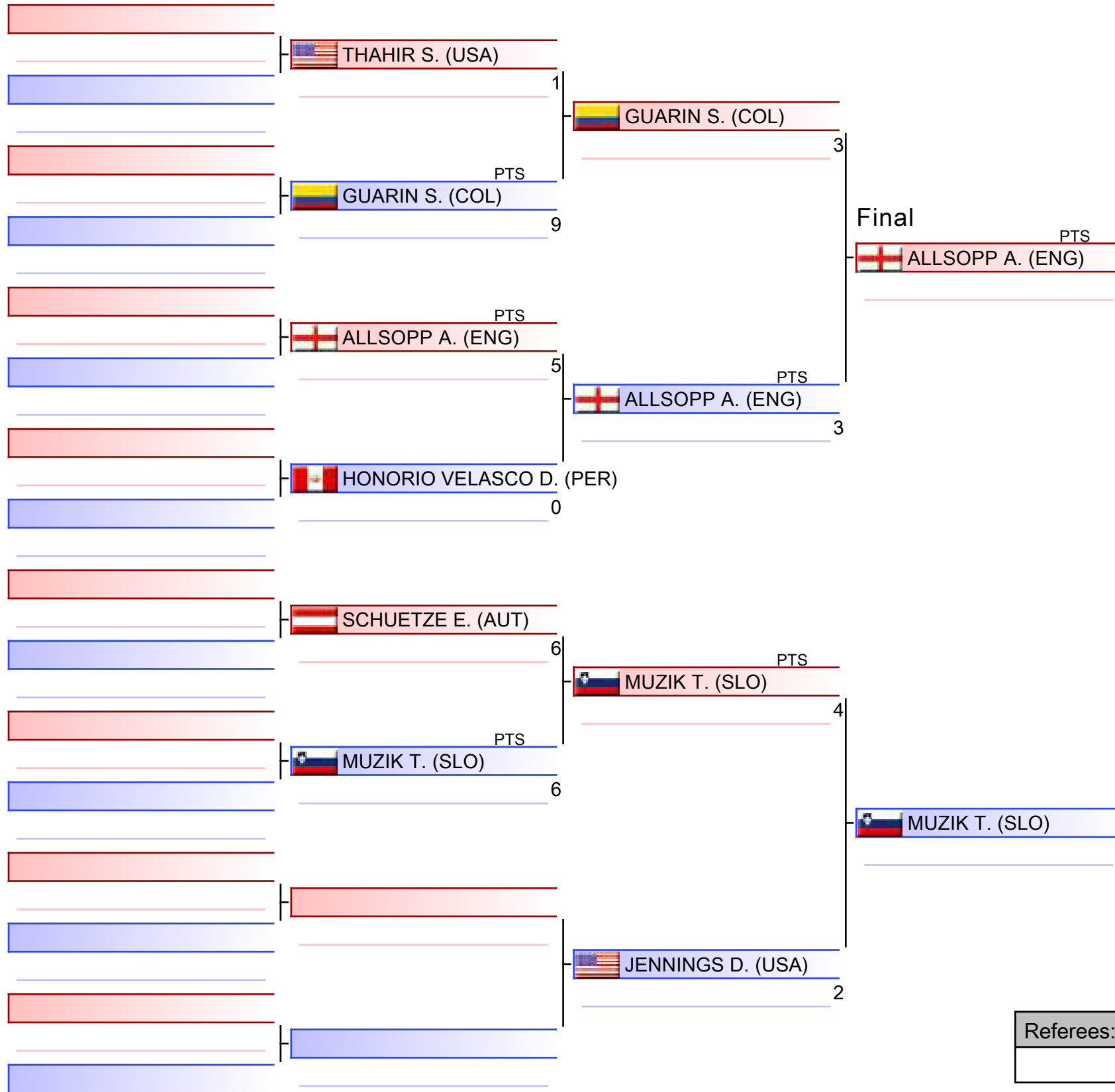

ALLSOPP A. (ENG)

1. ALLSOPP AMBER (ENG)
2. MUZIK TAŠA MAU (SLO)
3. GUARIN SOFIA (COL)
3. SCHUETZE EMMA (AUT)
5. HONORIO VELASCO DORIS FABIANA (PER)
5. JENNINGS DESTINY (USA)

Referees:			

U21 Kumite Female 68+ kg

Karate1 Youth League - Cancun 2024

2024-08-08

Tatami
1 15:00

Pool
1

(c)sportdata GmbH & Co KG 2000-2024 (2024-08-11 14:42) v 10.2.0 build 1 (2024-08-09 20:34 CET) License: Online_Event_ID-875_Karate1YouthLeagueCancun2024 (expire 2024-08-25)

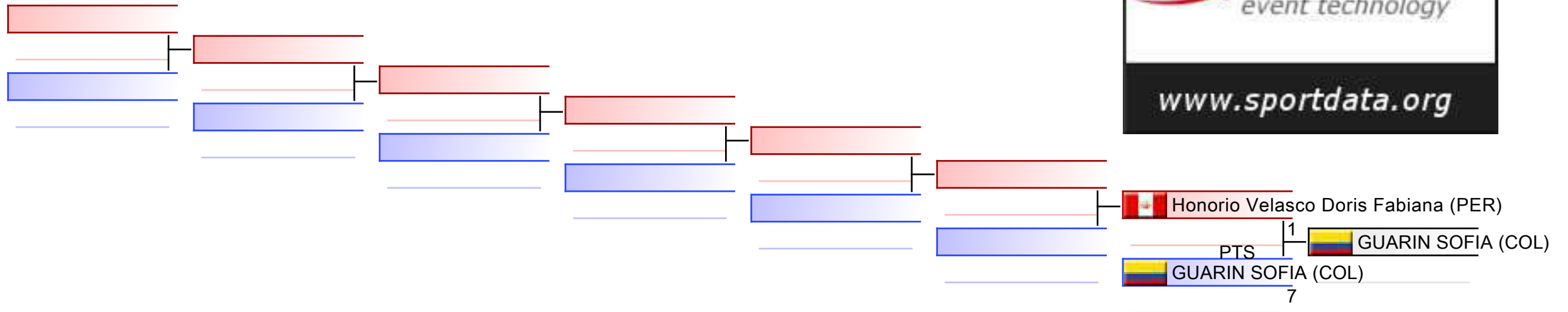

REPECHAGE: (1)

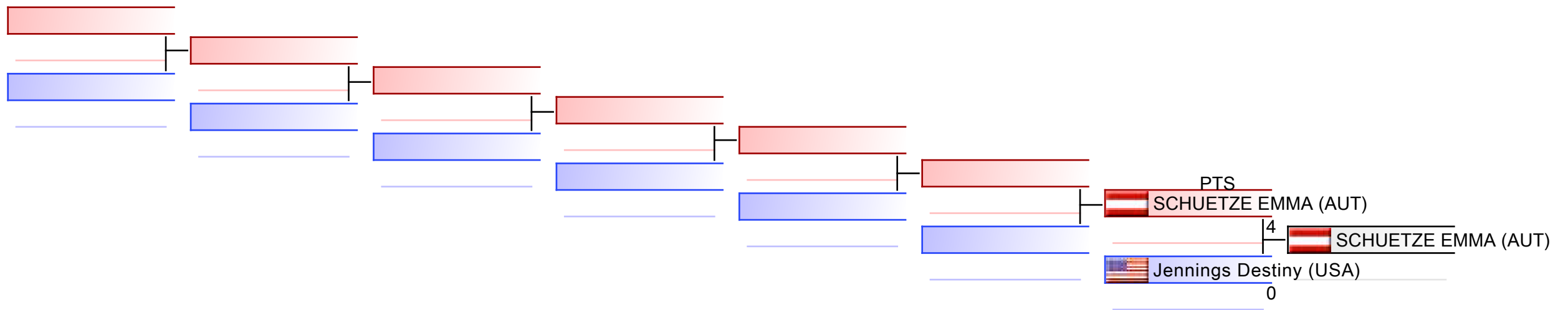

Referees:							
-----------	--	--	--	--	--	--	--



Karate1 Youth League - Cancun 2024 - 2024-08-08



Official Results

U21 Kumite Female 68+ kg			
1	ALLSOPP AMBER		ENG - ENGLAND
2	MUZIK TAŠA MAU		SLO - SLOVENIA
3	GUARIN SOFIA		COL - COLOMBIA
3	SCHUETZE EMMA		AUT - AUSTRIA
5	HONORIO VELASCO DORIS FABIANA		PER - PERU
5	JENNINGS DESTINY		USA - UNITED STATES

U21 KUMITE MALE -60 KG



Karate1 Youth League - Cancun 2024
ENTRIES BY WEIGHT CATEGORY



U21 Kumite Male -60 kg
As of 11 AUG 2024

NOC Code	Gender	Name	Seeding
ARG	M	GALLARDO JUAN IGNACIO	
CHI	M	CUEVAS NUNEZ JAVIER	
COL	M	MAINGUEZ NOGUERA JUAN CAMILO	
COL	M	PASTRANA SANTANA JORDI JOSE	
CRC	M	JARA JOSHUA	
GUA	M	Castillo Mazariego Jose Manuel	
MEX	M	BAUTISTA ESTEBAN	
MEX	M	CASTILLO CORTES ADRIAN	
PER	M	TUCTO SANCHEZ JUAN DIEGO	
POR	M	Oliveira Gustavo	
ROU	M	GOATA MATEI	
USA	M	Cruz Kevin	
USA	M	Dolinyan Davit	
USA	M	Dorta Janco	
USA	M	Dorta Jean	

U21 Kumite Male -60 kg

Karate1 Youth League - Cancun 2024, Iberostar Playa Paraíso Convention Center, Avenida del Sol Km 309, Playa Paraiso, 77710 Riviera Maya, MEX

2024-08-08

Tatami
1 11:15

Pool
1/2

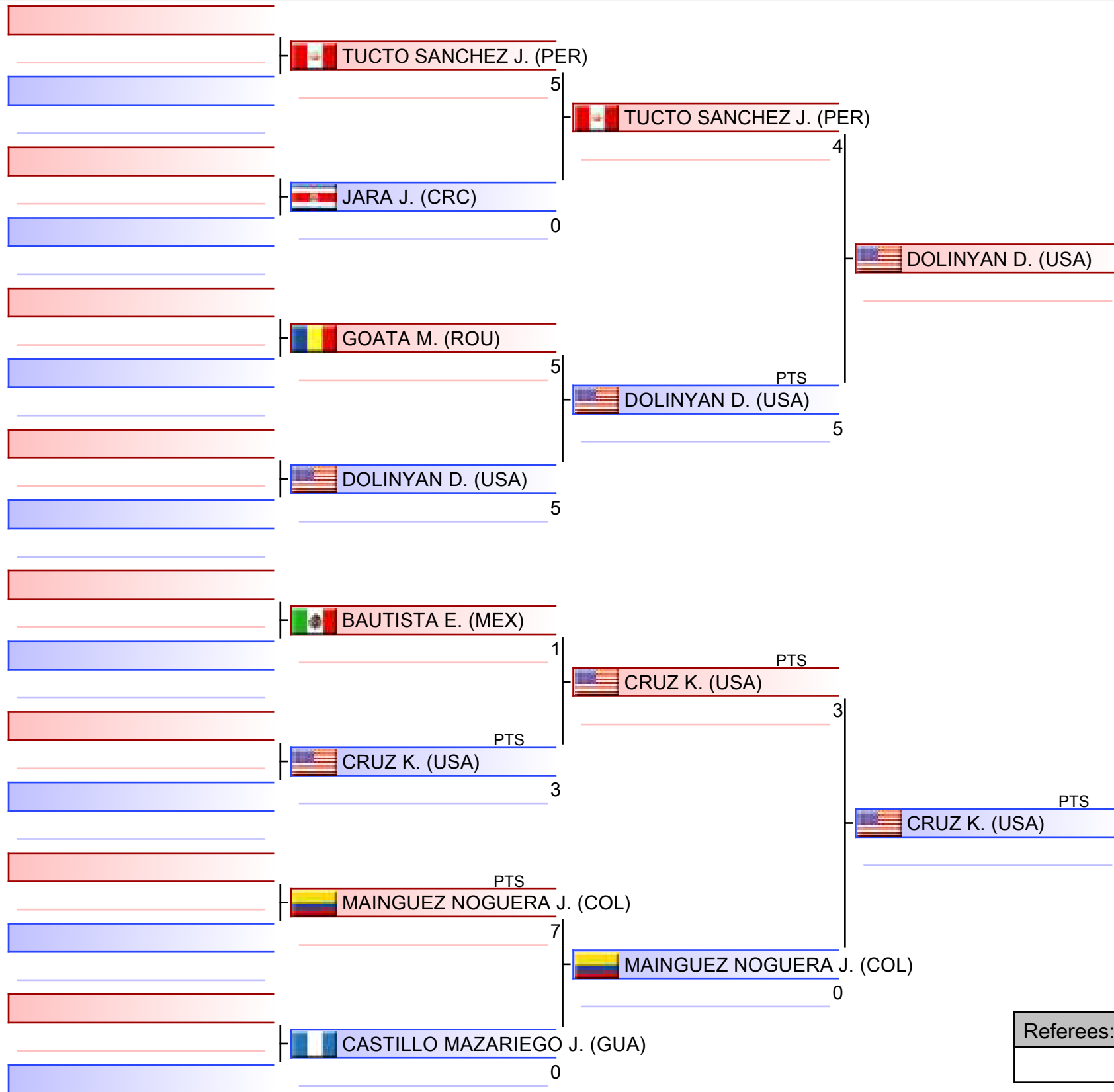

1. DORTA JANCO (USA)
2. CRUZ KEVIN (USA)
3. OLIVEIRA GUSTAVO (POR)
3. MAINGUEZ NOGUERA JUAN CAMILO (COL)
5. PASTRANA SANTANA JORDI JOSE (COL)
5. DOLINYAN DAVIT (USA)
7. GALLARDO JUAN IGNACIO (ARG)
7. BAUTISTA ESTEBAN (MEX)

Referees:			

U21 Kumite Male -60 kg

Karate1 Youth League - Cancun 2024, Iberostar Playa Paraíso Convention Center, Avenida del Sol Km 309, Playa Paraiso, 77710 Riviera Maya, MEX

2024-08-08

Tatami

2 11:15

Pool

2/2

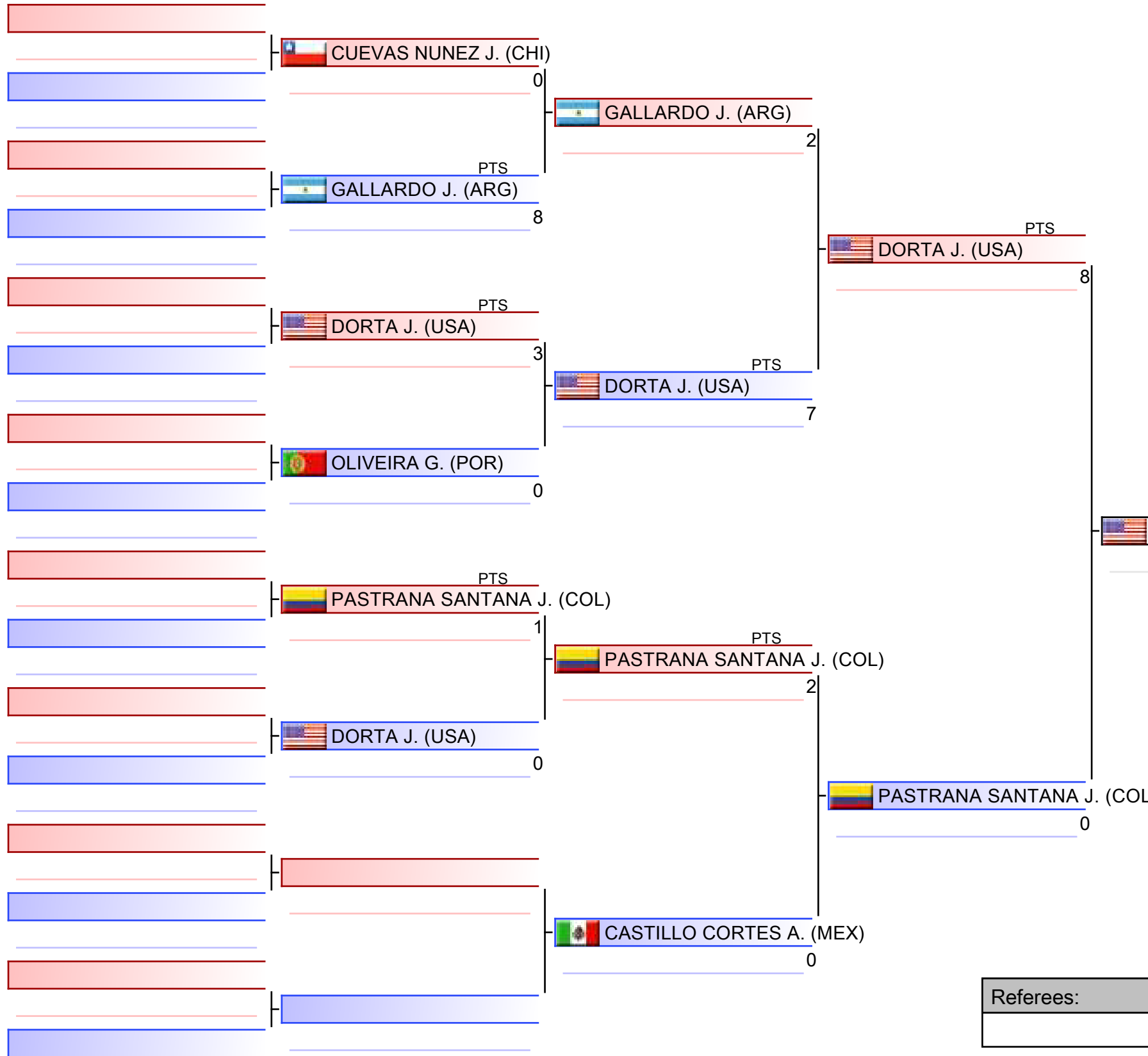

- | |
|---------------------------------------|
| 1. DORTA JANCO (USA) |
| 2. CRUZ KEVIN (USA) |
| 3. OLIVEIRA GUSTAVO (POR) |
| 3. MAINGUEZ NOGUERA JUAN CAMILO (COL) |
| 5. PASTRANA SANTANA JORDI JOSE (COL) |
| 5. DOLINYAN DAVIT (USA) |
| 7. GALLARDO JUAN IGNACIO (ARG) |
| 7. BAUTISTA ESTEBAN (MEX) |

Referees:			

Pool winner-U21 Kumite Male -60 kg

Karate1 Youth League - Cancun 2024, Iberostar Playa Paraiso Convention Center, Avenida del Sol Km 309, Playa Paraiso, 77710 Riviera Maya, MEX

Tatami

Pool

1/1

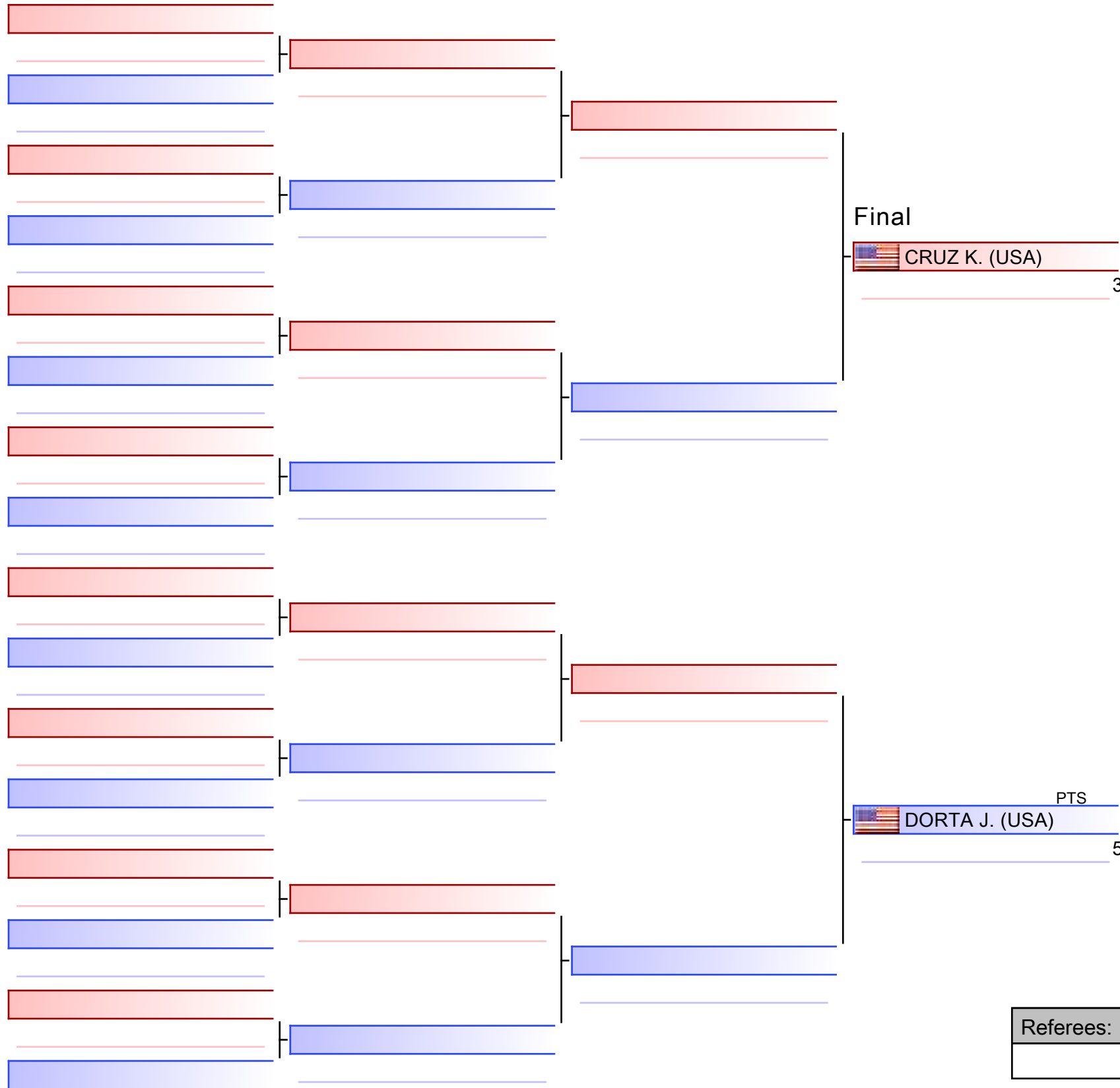

Final
 CRUZ K. (USA) 3
 DORTA J. (USA) 5

1. DORTA JANCO (USA)
2. CRUZ KEVIN (USA)
3. OLIVEIRA GUSTAVO (POR)
3. MAINGUEZ NOGUERA JUAN CAMILO (COL)
5. PASTRANA SANTANA JORDI JOSE (COL)
5. DOLINYAN DAVIT (USA)
7. GALLARDO JUAN IGNACIO (ARG)
7. BAUTISTA ESTEBAN (MEX)

Referees:			

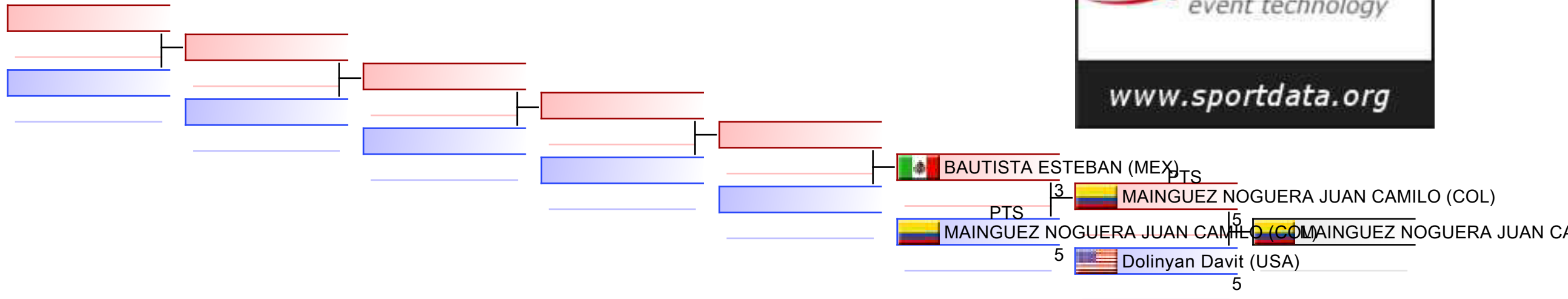

REPECHAGE: (1,2)

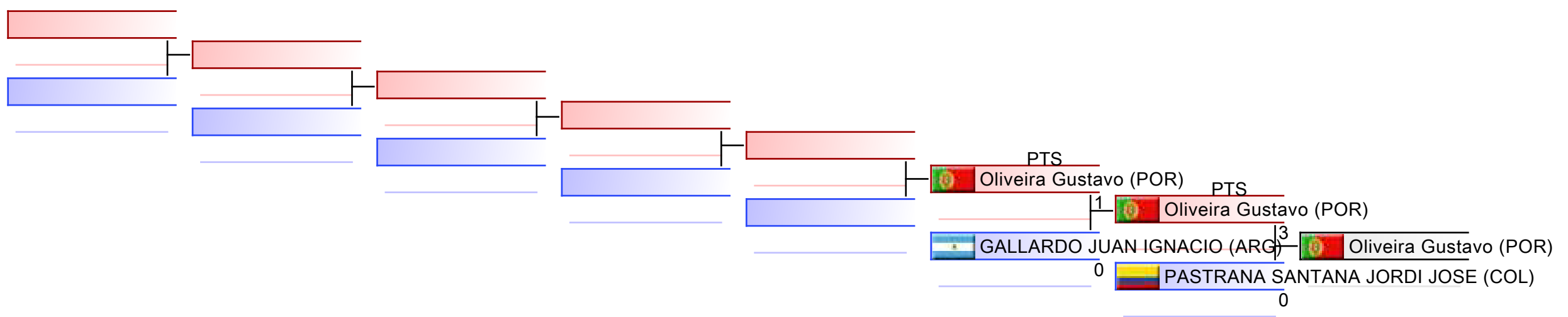

Referees:							
-----------	--	--	--	--	--	--	--



Karate1 Youth League - Cancun 2024 - 2024-08-08



Official Results

U21 Kumite Male -60 kg			
1	DORTA JANCO		USA - UNITED STATES
2	CRUZ KEVIN		USA - UNITED STATES
3	OLIVEIRA GUSTAVO		POR - PORTUGAL
3	MAINGUEZ NOGUERA JUAN CAMILO		COL - COLOMBIA
5	PASTRANA SANTANA JORDI JOSE		COL - COLOMBIA
5	DOLINYAN DAVIT		USA - UNITED STATES
7	GALLARDO JUAN IGNACIO		ARG - ARGENTINA
7	BAUTISTA ESTEBAN		MEX - MEXICO

U21 KUMITE MALE -67 KG



Karate1 Youth League - Cancun 2024
ENTRIES BY WEIGHT CATEGORY



U21 Kumite Male -67 kg
As of 11 AUG 2024

NOC Code	Gender	Name	Seeding
ARU	M	PRADA SUNCO KEVEN	
BEL	M	Ejja Amine	
CHI	M	ARCE ZUNIGA BASTIAN	
CHI	M	Jara Muñoz Maximiliano Ignacio	
COL	M	BAENA TAMAYO MATEO	
COL	M	Olmos quintana Juan David	
DEN	M	Linaa Mathias Bech	
ENG	M	Flounders Joseph	
ENG	M	Monk Luke	
GUA	M	CHACON MAZARIEGOS DIEGO ERNESTO	
HKG	M	KWOK HO HIM	
MEX	M	Vega Batiz Carlos Santiago	
MEX	M	VIDEGARAY PEREZ PATRICIO	
MEX	M	YOSHII MIZUKAMI HIROTO JAVIER	
PAR	M	RINCK DIETER	
POL	M	Dziuda Dominik	
POR	M	Alves Rafael	
POR	M	Gonçalves Guilherme	
SUI	M	Torres Steven	
USA	M	Solis Mateo	
VEN	M	Gamez Gian	

U21 Kumite Male -67 kg

Karate1 Youth League - Cancun 2024, Iberostar Playa Paraíso Convention Center, Avenida del Sol Km 309, Playa Paraiso, 77710 Riviera Maya, MEX

2024-08-08

Tatami
3 12:05

Pool
1/2

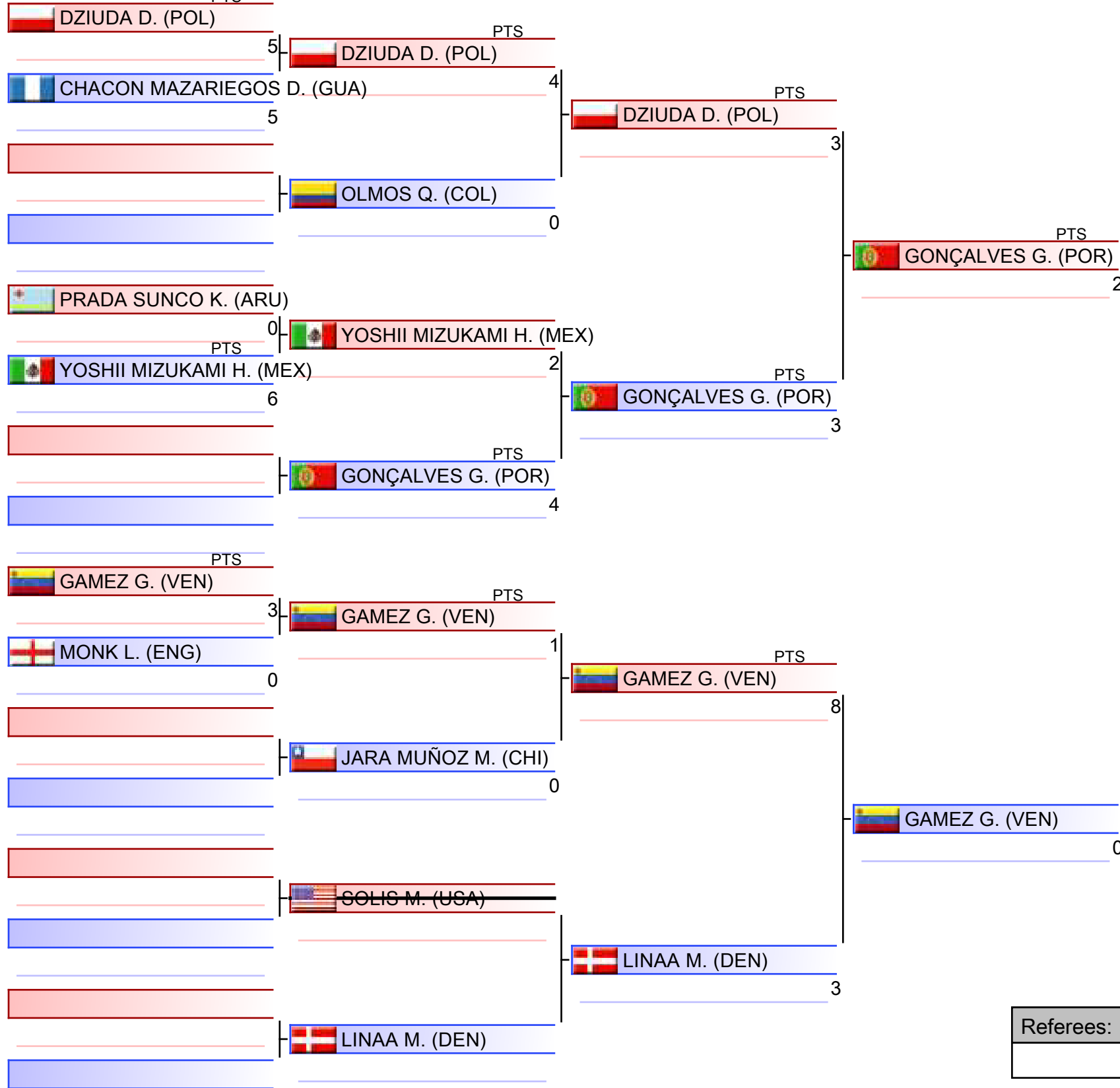

1. ALVES RAFAEL (POR)
2. GONÇALVES GUILHERME (POR)
3. VIDEGARAY PEREZ PATRICIO (MEX)
3. DZIUDA DOMINIK (POL)
5. TORRES STEVEN (SUI)
5. GAMEZ GIAN (VEN)
7. BAENA TAMAYO MATEO (COL)
7. YOSHII MIZUKAMI HIROTO JAVIER (MEX)

Referees:			

U21 Kumite Male -67 kg

Karate1 Youth League - Cancun 2024, Iberostar Playa Paraíso Convention Center, Avenida del Sol Km 309, Playa Paraiso, 77710 Riviera Maya, MEX

2024-08-08

Tatami
4 12:40

Pool
2/2

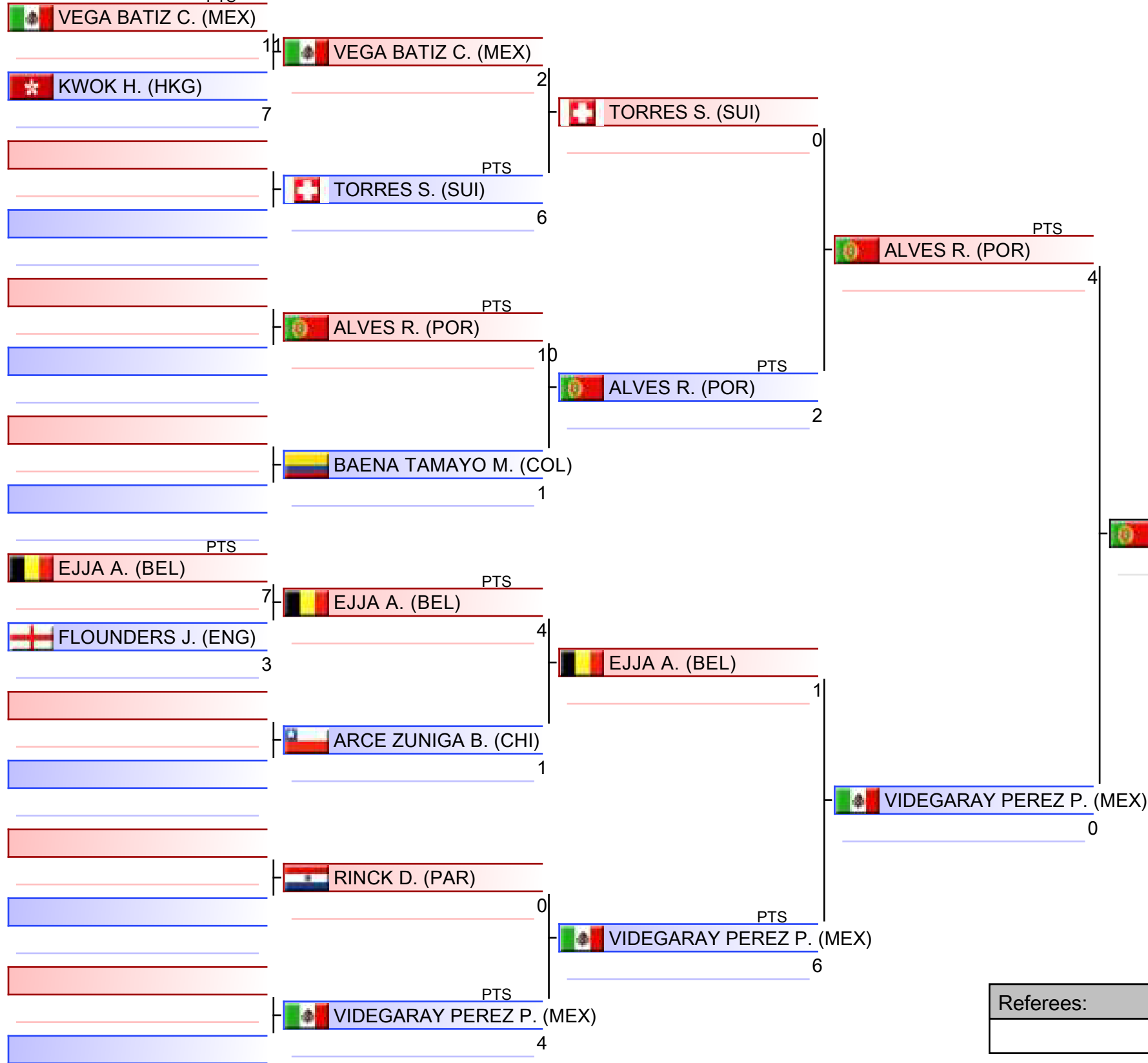

- | |
|--|
| 1. ALVES RAFAEL (POR) |
| 2. GONÇALVES GUILHERME (POR) |
| 3. VIDEOGARAY PEREZ PATRICIO (MEX) |
| 3. DZIUDA DOMINIK (POL) |
| 5. TORRES STEVEN (SUI) |
| 5. GAMEZ GIAN (VEN) |
| 7. BAENA TAMAYO MATEO (COL) |
| 7. YOSHII MIZUKAMI HIROTO JAVIER (MEX) |

Referees:			

Pool winner-U21 Kumite Male -67 kg

Karate1 Youth League - Cancun 2024, Iberostar Playa Paraíso Convention Center, Avenida del Sol Km 309, Playa Paraiso, 77710 Riviera Maya, MEX

Tatami

Pool

1/1

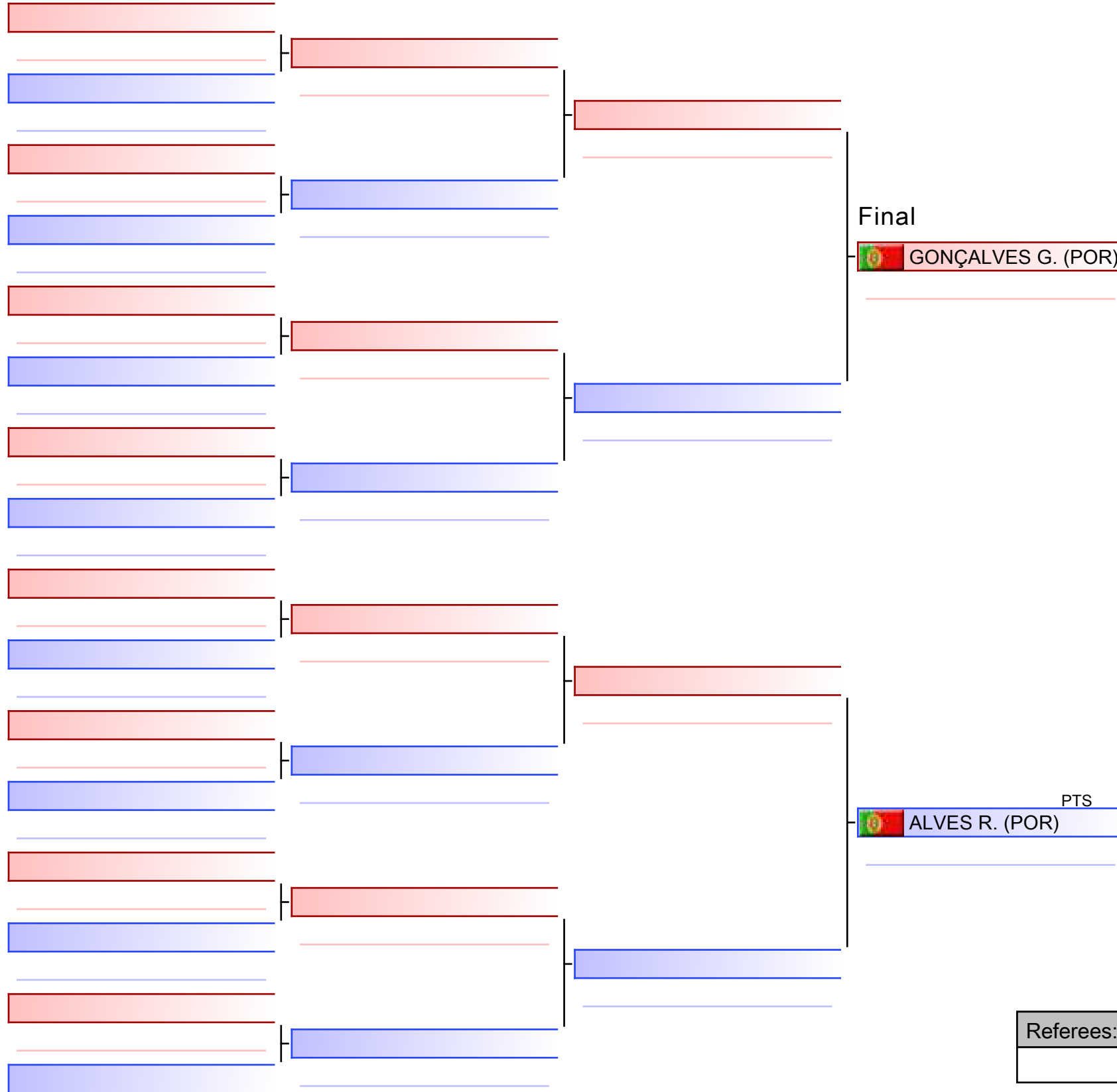

Final

GONÇALVES G. (POR)

1

ALVES R. (POR)

PTS

ALVES R. (POR)

4

1. ALVES RAFAEL (POR)
2. GONÇALVES GUILHERME (POR)
3. VIDEGARAY PEREZ PATRICIO (MEX)
3. DZIUDA DOMINIK (POL)
5. TORRES STEVEN (SUI)
5. GAMEZ GIAN (VEN)
7. BAENA TAMAYO MATEO (COL)
7. YOSHII MIZUKAMI HIROTO JAVIER (MEX)

Referees:			

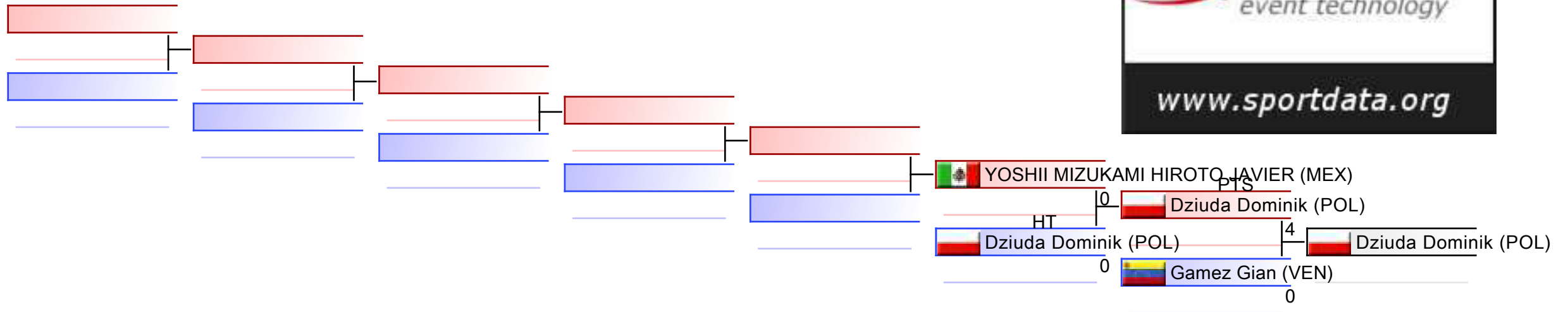

REPECHAGE: (1,2)

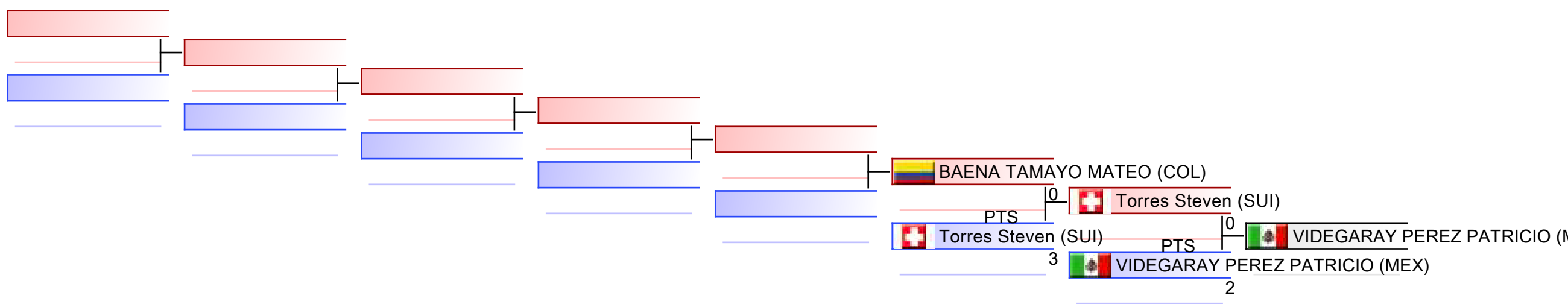

Referees:							
-----------	--	--	--	--	--	--	--



Karate1 Youth League - Cancun 2024 - 2024-08-08



Official Results

U21 Kumite Male -67 kg			
1	ALVES RAFAEL		POR - PORTUGAL
2	GONÇALVES GUILHERME		POR - PORTUGAL
3	VIDEGARAY PEREZ PATRICIO		MEX - MEXICO
3	DZIUDA DOMINIK		POL - POLAND
5	TORRES STEVEN		SUI - SWITZERLAND
5	GAMEZ GIAN		VEN - VENEZUELA
7	BAENA TAMAYO MATEO		COL - COLOMBIA
7	YOSHII MIZUKAMI HIROTO JAVIER		MEX - MEXICO

U21 KUMITE MALE -75 KG



Karate1 Youth League - Cancun 2024
ENTRIES BY WEIGHT CATEGORY



U21 Kumite Male -75 kg
As of 11 AUG 2024

NOC Code	Gender	Name	Seeding
BRA	M	Gonçalves Negri Pedro	
COL	M	gomez tobon jose david	
COL	M	MONTOYA CARDOZO CESAR STIVEN	
CZE	M	Šťáhlavský Ondřej	
MEX	M	CURIEL ALARCON SANTIAGO	
MEX	M	GUTIERREZ MADRIGAL KAROL DANIEL	
MEX	M	LEDESMA LUNA ISAAC RAFAEL	
MEX	M	YOSHII MIZUKAMI HAYATO FRANCISCO	
PER	M	BACHOIR VEGA ANDRE LOUIS	
POR	M	Fernandes Bernardo Pineu	
POR	M	Inacio Diogo	
USA	M	Corbin Joshua	
USA	M	Kasturi Sahil	

U21 Kumite Male -75 kg

Karate1 Youth League - Cancun 2024, Iberostar Playa Paraíso Convention Center, Avenida del Sol Km 309, Playa Paraiso, 77710 Riviera Maya, MEX

2024-08-08

Tatami
1 12:35

Pool
1/1

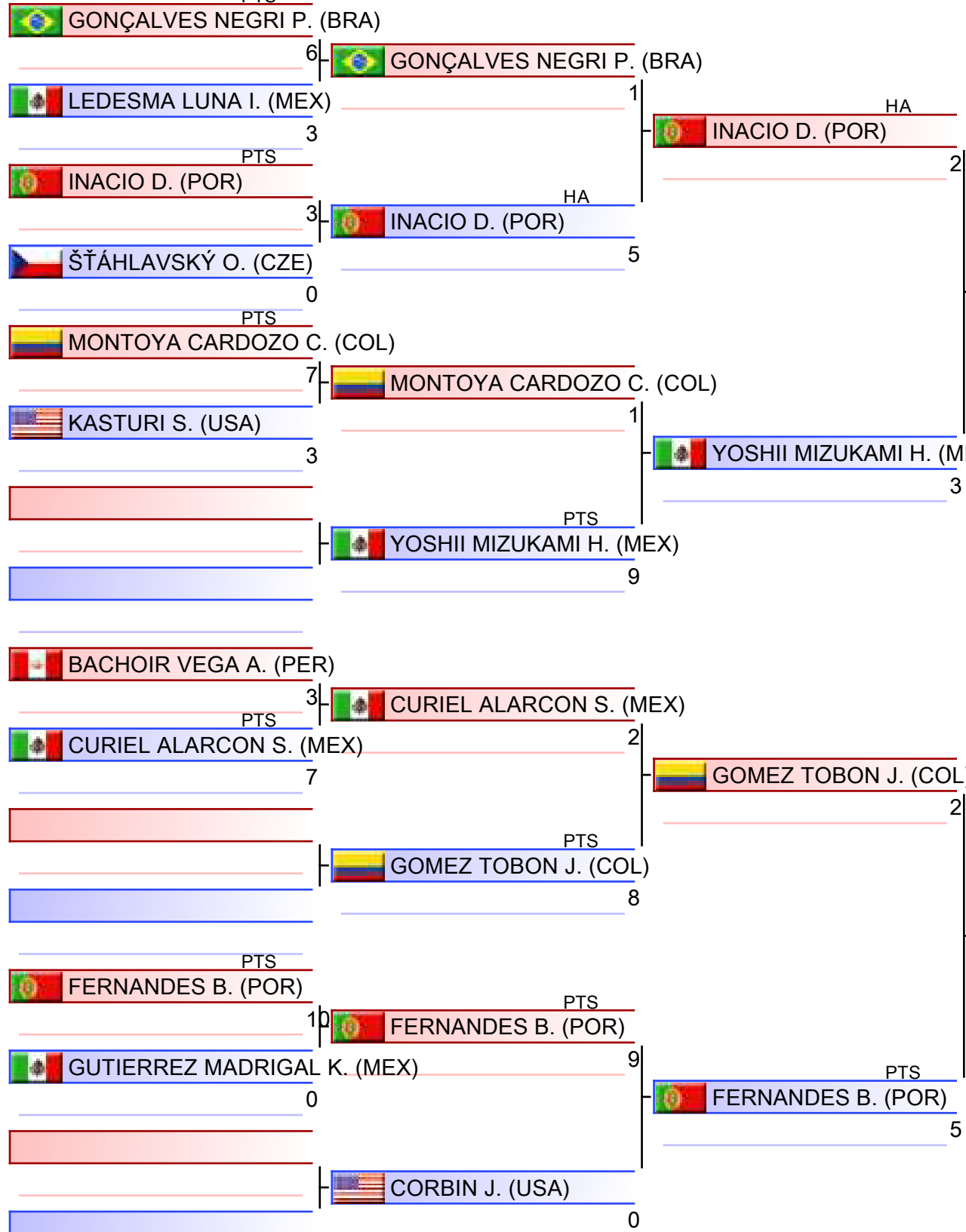

- | |
|---|
| 1. FERNANDES BERNARDO PINEU (POR) |
| 2. INACIO DIOGO (POR) |
| 3. GOMEZ TOBON JOSE DAVID (COL) |
| 3. YOSHII MIZUKAMI HAYATO FRANCISCO (MEX) |
| 5. CORBIN JOSHUA (USA) |
| 5. ŠŤÁHLAVSKÝ ONDŘEJ (CZE) |
| 7. GUTIERREZ MADRIGAL KAROL DANIEL (MEX) |
| 7. GONÇALVES NEGRI PEDRO (BRA) |

Referees:			

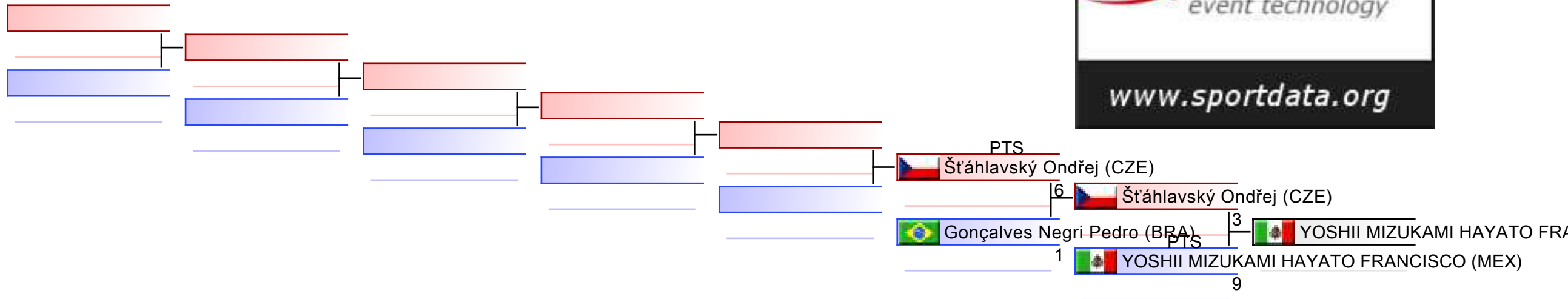

REPECHAGE: (1)

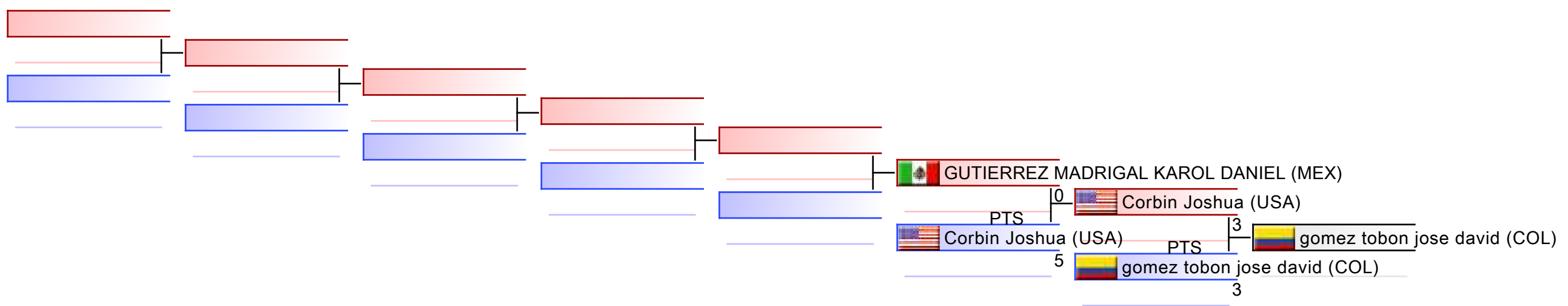

Referees:							
-----------	--	--	--	--	--	--	--



Karate1 Youth League - Cancun 2024 - 2024-08-08



Official Results

U21 Kumite Male -75 kg			
1	FERNANDES BERNARDO PINEU		POR - PORTUGAL
2	INACIO DIOGO		POR - PORTUGAL
3	GOMEZ TOBON JOSE DAVID		COL - COLOMBIA
3	YOSHII MIZUKAMI HAYATO FRANCISCO		MEX - MEXICO
5	CORBIN JOSHUA		USA - UNITED STATES
5	ŠTAHLAVSKÝ ONDŘEJ		CZE - CZECH REPUBLIC
7	GUTIERREZ MADRIGAL KAROL DANIEL		MEX - MEXICO
7	GONÇALVES NEGRI PEDRO		BRA - BRAZIL

U21 KUMITE MALE -84 KG



Karate1 Youth League - Cancun 2024
ENTRIES BY WEIGHT CATEGORY



U21 Kumite Male -84 kg
As of 11 AUG 2024

NOC Code	Gender	Name	Seeding
CHI	M	PONCE SOTO HECTOR	
COL	M	ospina soscue santiago	
ENG	M	Walker Ollie	
EST	M	Mets Mihkel	
GUA	M	GARCIA MONTT JOSE EMILIANO	
ISL	M	Halldórsson Hugi	
MEX	M	CARAVANTES MONTOYA ARIF ENRIQUE	
MEX	M	GARCIA GARCIA JESUS FRANCISCO	
USA	M	Buka Yan	
USA	M	Saunders-Long Tristan	

U21 Kumite Male -84 kg

Karate1 Youth League - Cancun 2024, Iberostar Playa Paraíso Convention Center, Avenida del Sol Km 309, Playa Paraiso, 77710 Riviera Maya, MEX

2024-08-08

Tatami
2 14:00

Pool
1/1

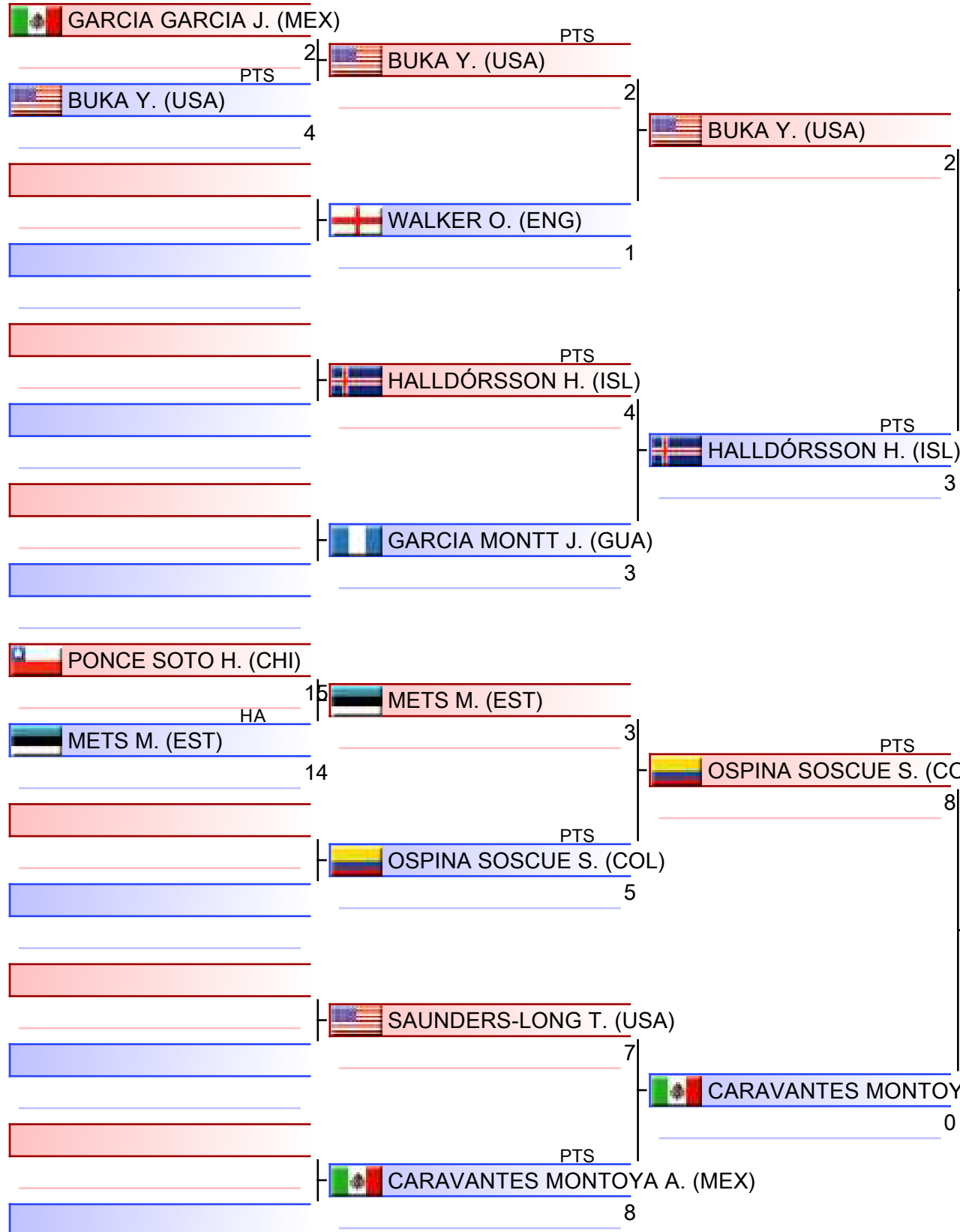

1. OSPINA SOSCUE SANTIAGO (COL)
2. HALLDÓRSSON HUGI (ISL)
3. METS MIHKEL (EST)
3. BUKA YAN (USA)
5. CARAVANTES MONTOYA ARIF ENRIQUE (MEX)
5. GARCIA MONTT JOSE EMILIANO (GUA)

Referees:			

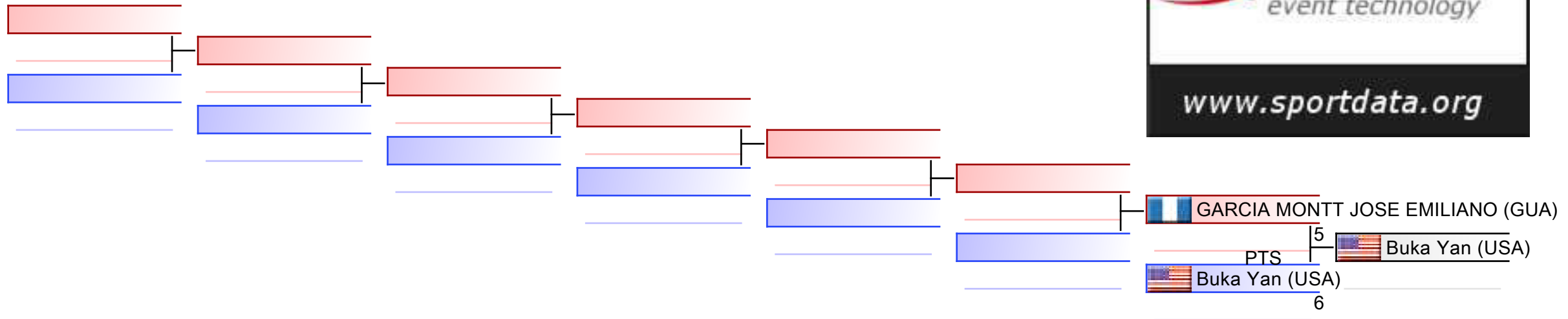

REPECHAGE: (1)

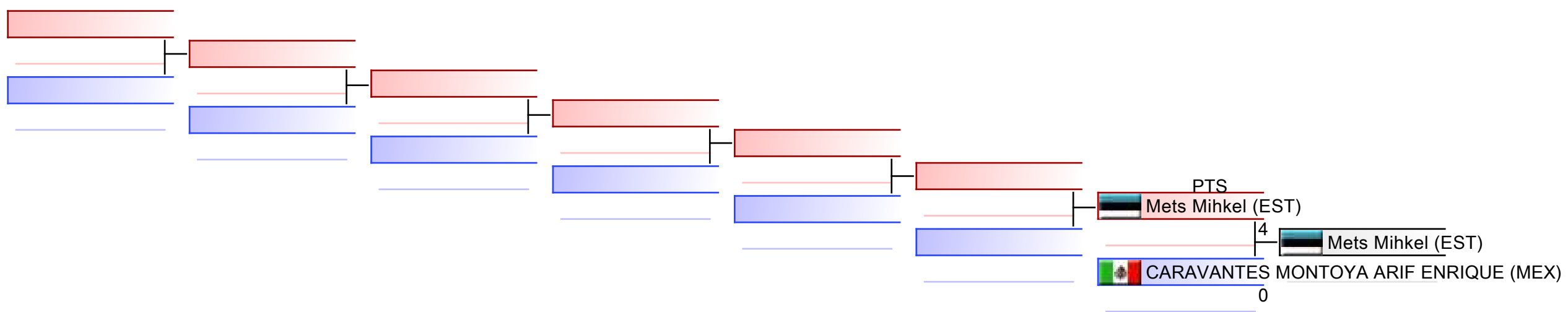

Referees:							
-----------	--	--	--	--	--	--	--



Karate1 Youth League - Cancun 2024 - 2024-08-08



Official Results

U21 Kumite Male -84 kg			
1	OSPINA SOSCUE SANTIAGO		COL - COLOMBIA
2	HALLDÓRSSON HUGI		ISL - ICELAND
3	METS MIHKEL		EST - ESTONIA
3	BUKA YAN		USA - UNITED STATES
5	CARAVANTES MONTOYA ARIF ENRIQUE		MEX - MEXICO
5	GARCIA MONTT JOSE EMILIANO		GUA - GUATEMALA

U21 KUMITE MALE 84+ KG



Karate1 Youth League - Cancun 2024
ENTRIES BY WEIGHT CATEGORY



U21 Kumite Male 84+ kg
As of 11 AUG 2024

NOC Code	Gender	Name	Seeding
CAN	M	DE LANDA ZISKROUT ISAAC	
COL	M	GAMBOA NICOLAS	
COL	M	hernandez meneses yoseph ferney	
MEX	M	AVILA IBARRA SALVADOR	
MEX	M	PADILLA GARCIA ISAAC GAEL	
MEX	M	rodriguez gonzalez miguel angel	
MEX	M	VELASCO MARQUEZ ALBERTO	
PAR	M	BRITOS IVAN	
USA	M	White Jared	
VEN	M	ALEJANDRO LABRADOR	
VEN	M	Sanchez Marquez Joaquin Adolfo	
WAL	M	Preece Nathan	

U21 Kumite Male 84+ kg

Karate1 Youth League - Cancun 2024

2024-08-08

Tatami
3 14:25

Pool
1

(c)sportdata GmbH & Co KG 2000-2024 (2024-08-11 14:42) v 10.2.0 build 1 (2024-08-09 20:34 CET) License: Online_Event_ID-875_Karate1YouthLeagueCancun2024 (expire 2024-08-25)

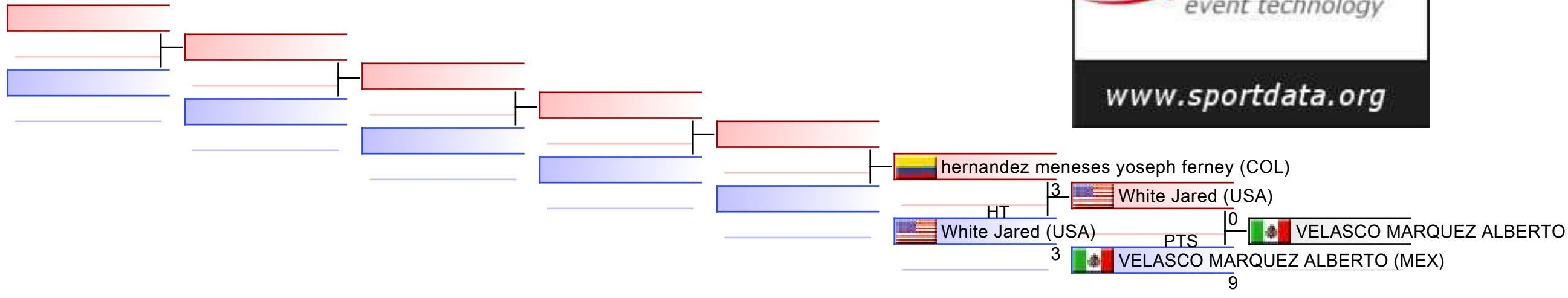

REPECHAGE: (1)

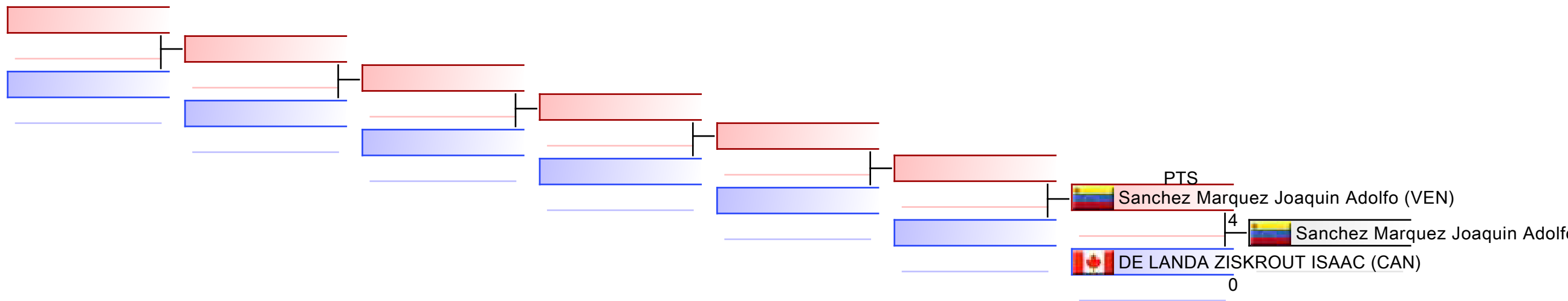

Referees:							
-----------	--	--	--	--	--	--	--



Karate1 Youth League - Cancun 2024 - 2024-08-08



Official Results

U21 Kumite Male 84+ kg			
1	PADILLA GARCIA ISAAC GAEL		MEX - MEXICO
2	BRITOS IVAN		PAR - PARAGUAY
3	VELASCO MARQUEZ ALBERTO		MEX - MEXICO
3	SANCHEZ MARQUEZ JOAQUIN ADOLFO		VEN - VENEZUELA
5	WHITE JARED		USA - UNITED STATES
5	DE LANDA ZISKROUT ISAAC		CAN - CANADA
7	HERNANDEZ MENESES YOSEPH FERNEY		COL - COLOMBIA



Official Results

Cadet Kata Female			
1	VAUCELLE-SPELLE NINON		FRA - FRANCE
2	SANCHEZ ISABELLA		USA - UNITED STATES
3	COTTINGHAM EMMERSYN		USA - UNITED STATES
3	LEHNER TAMARA		AUT - AUSTRIA
5	PLIEGO MALDONADO ESTEFANY QUETZALLI		MEX - MEXICO
5	DEODHARI SIERRA		USA - UNITED STATES
7	DE LUCA AGUSTINA SOFIA		CHI - CHILE
7	GATTA LINDA		ITA - ITALY
9	AFENDIKOVA NIKA		UKR - UKRAINE

Cadet Kata Male			
1	LIBORIO GUSTAVO		BRA - BRAZIL
2	TURCATO GIACOMO FILIPPO		ITA - ITALY
3	ISA CHEON		USA - UNITED STATES
3	GONZALEZ RAZO GABRIEL		MEX - MEXICO
5	ERHARDT TRULS		SWE - SWEDEN
5	LÜTHY CORSIN DION		SUI - SWITZERLAND
7	ŠTAHLAVSKÝ DAVID		CZE - CZECH REPUBLIC
7	NGUYEN ANDERSEN		USA - UNITED STATES
9	JIMENEZ MATIAS		CRC - COSTA RICA
9	BONILLAS NICOLAS		CRC - COSTA RICA

Cadet Kumite Female -47 kg			
1	MATOS ISIS		POR - PORTUGAL
2	ABU-RAHMA MARIAM		USA - UNITED STATES
3	SANCHEZ ISABELLA		USA - UNITED STATES
3	FERNANDES EMA PINÉU		POR - PORTUGAL
5	CHOI LAWRENCE LUCY		AUS - AUSTRALIA
5	RODRIGUEZ ISABELLA		CRC - COSTA RICA
7	CATALAN BARRIENTOS ANETTE		MEX - MEXICO
7	ROSALES MATA GEMA SELENIA		MEX - MEXICO

Cadet Kumite Female -54 kg			
1	GONÇALVES LEONOR		POR - PORTUGAL
2	VARANDA GABRIELA		POR - PORTUGAL
3	ESCOBEDO CASTANEDA METZTLI		MEX - MEXICO
3	ANDREEVSKI ANGELINA		USA - UNITED STATES
5	GUAITARILLA KAMILA		USA - UNITED STATES
5	CONTRERAS VILLAVICENCIO BIANCA AMYRA		CHI - CHILE
7	LONDONO ANDREA VALENTINA		COL - COLOMBIA
7	GARZA VIZCAINO VALENTINA		MEX - MEXICO

Cadet Kumite Female -61 kg			
1	BATH HANNAH		DEN - DENMARK
2	RAHMANI AYA		CAN - CANADA



Official Results

3	MAGDALENIC PAULINA		CRO - CROATIA	
3	SKIBA BIRKELBACH AMELIE YAIZA		ESP - SPAIN	
5	SERRANO JIMENEZ SOPHIA YAHALI		MEX - MEXICO	
5	REYES REYNA EMILIA ESTER		GUA - GUATEMALA	
7	OYARCE AGUSTINA		CHI - CHILE	
7	CONGONA LEON GERALDINE NICOLE		PER - PERU	

Cadet Kumite Female 61+ kg

1	KEMETINGER SARAH		AUT - AUSTRIA	
2	HARLING SKYLA		USA - UNITED STATES	
3	GUERRERO MARIANA		CAN - CANADA	
3	EWING MAIA		SCO - SCOTLAND	
5	AGUILERA PEREZ PAULA		CHI - CHILE	
5	ALVARADO MYHELLEN		CHI - CHILE	
7	SEPÚLVEDA LY FLAVIA EMILIA		CHI - CHILE	
7	SCHINDLER MILEY		GER - GERMANY	
9	MENDOZA PEREZ XADANI XIOMARA		MEX - MEXICO	

Cadet Kumite Male -52 kg

1	ZECCA LUCAS		SUI - SWITZERLAND	
2	FILIAGKOS ATHANASIOS		GRE - GREECE	
3	GUEVARA VALDEZ DANIEL ALEJANDRO		MEX - MEXICO	
3	PETAGNA LOPEZ PAOLO		ESP - SPAIN	
5	NUNEZ AARON		USA - UNITED STATES	
5	SANCHEZ BAHAMONDE VICENTE		CHI - CHILE	
7	BELFAND PAUL		USA - UNITED STATES	
7	SALGADO RUEDA DIEGO		MEX - MEXICO	

Cadet Kumite Male -57 kg

1	HOERNER PAUL-WILLIBALD		GER - GERMANY	
2	TEIXEIRA PENA ANDRÉ FILIPE		POR - PORTUGAL	
3	LOBOS MACEDO RODRIGO		CHI - CHILE	
3	CARRERA RUBILAR LUCIAN		CHI - CHILE	
5	YOSHII MIZUKAMI KAITO DANIEL		MEX - MEXICO	
5	SIXTO GARCIA IZEL OCELOTL		MEX - MEXICO	
7	PEREZ LOPEZ SANTIAGO		MEX - MEXICO	
7	EVANS RASANDRE VALENTINO		JAM - JAMAICA	

Cadet Kumite Male -63 kg

1	TODOROVIC FILIP		LUX - LUXEMBOURG	
2	RIVERA RIVERA RICARDO JENIEL		PUR - PUERTO RICO	
3	NIEDERELZ TIM		GER - GERMANY	
3	FARRIS LOGAN		USA - UNITED STATES	
5	DE ABREU DE ABREU SANTIAGO		VEN - VENEZUELA	
5	FLORES ORTIZ JORGE DAMIAN		GUA - GUATEMALA	
7	GARCÍA MENESES IGNACIO SALVADOR		MEX - MEXICO	
7	RODRIGUEZ SANTIAGO		CRC - COSTA RICA	



Official Results

9	ARRIAGADA PAVEZ INAKI		CHI - CHILE	
9	HIGUERA ROMERO CARLOS FRANCISCO		MEX - MEXICO	

Cadet Kumite Male -70 kg

1	VALERO JESUS		VEN - VENEZUELA	
2	MUÑOZ CONTRERAS SEBASTIAN		CHI - CHILE	
3	CARRENO OLAVARRIA VICENTE		CHI - CHILE	
3	SLUKIC PETAR		CRO - CROATIA	
5	JIMENEZ MATIAS		CRC - COSTA RICA	
5	DAVILA MARTIN		USA - UNITED STATES	
7	TORDECILLA FELIPE		COL - COLOMBIA	
7	MOJICA SOTO IAN NICKOLAS		MEX - MEXICO	

Cadet Kumite Male 70+ kg

1	ADJANONHOUN IHSANE		FRA - FRANCE	
2	SOLTIC ERVIN		CRO - CROATIA	
3	PEREZ GUTIERREZ MARCO ANTONIO		MEX - MEXICO	
3	MITRIK RICHARD		SVK - SLOVAKIA	
5	CONCHA SEPULVEDA JORGE		CHI - CHILE	
5	ROLDAN REYNA JOSE MIGUEL		GUA - GUATEMALA	
7	PERERA TAMAY CHRISTOPHER JESUS		MEX - MEXICO	
7	REYNA CANO ORLANDO		MEX - MEXICO	

Junior Kata Female

1	BUI MAI-LINH		FRA - FRANCE	
2	MARQUES RITA		POR - PORTUGAL	
3	OLIVEIRA INÉS		POR - PORTUGAL	
3	OLIGINO DIANA VALENTINA		VEN - VENEZUELA	
5	CERROS ELENA ISABEL		ESA - EL SALVADOR	
5	CARDONA GRAJALES SARA		COL - COLOMBIA	
7	COLLELA YASMIN		BRA - BRAZIL	
7	NORMAN PORTILLA KATHERINNE MARYCIELO		MEX - MEXICO	
9	JOCIC ALEXA		USA - UNITED STATES	

Junior Kata Male

1	DI RUBBA LUIGI		ITA - ITALY	
2	NARVAEZ MARCO		ECU - ECUADOR	
3	CAPONERA EMANUELE		ITA - ITALY	
3	WU TIMON		AUT - AUSTRIA	
5	SANTOS LANCE		USA - UNITED STATES	
5	NACU MATEO		USA - UNITED STATES	
7	GARCIA VALADEZ JUAN PABLO		MEX - MEXICO	
7	SCHEDL NOLAN		SUI - SWITZERLAND	
9	RODRIGUEZ SEBASTIAN		CRC - COSTA RICA	
9	GARZA VIZCAINO JOSE MARCELO		MEX - MEXICO	



Official Results

Junior Kumite Female -48 kg			
1	TRSTENJAK AIDA		CRO - CROATIA
2	DREHMANN EMILY-CHIARA		GER - GERMANY
3	VALDERRAMA GARCIA VALERIA		COL - COLOMBIA
3	FLORES ORTIZ MARIA RENEE		GUA - GUATEMALA
5	GENTA MICOL		ITA - ITALY
5	CABRERA PALOMINO GLORIA YESENIA		MEX - MEXICO
7	JOCIC ALEXA		USA - UNITED STATES

Junior Kumite Female -53 kg			
1	MCCAMMON BRIELYN		USA - UNITED STATES
2	CHLEBOWSKA ANNA		POL - POLAND
3	VIZCAINO CALVO RUTH		ESP - SPAIN
3	SANCHEZ QUICENO JULIETA		COL - COLOMBIA
5	REYNA CANO AYLIN YAMILET		MEX - MEXICO
5	FERRETO JIMENEZ ANGHELINA		CRC - COSTA RICA
7	CONTRERAS MUNOZ ANA KARENI		MEX - MEXICO
7	DELAROSA KIARA		CAN - CANADA

Junior Kumite Female -59 kg			
1	HELLEN ILI		GER - GERMANY
2	CETIN CEYLIN		AUT - AUSTRIA
3	CARDONA GRAJALES SARA		COL - COLOMBIA
3	MUSSWEILER MIA		GER - GERMANY
5	JAWKAR ANUSHKA		CAN - CANADA
5	LEE AMANDA		CAN - CANADA
7	RAMOS ALONSO RENATA		MEX - MEXICO

Junior Kumite Female -66 kg			
1	ZEUMEROVA ALEXANDRA		SVK - SLOVAKIA
2	BATH ASTAMAJA		DEN - DENMARK
3	VALK IMANE		NED - NETHERLANDS
3	AGUILAR ALBIZURES MARIA RENEE		GUA - GUATEMALA
5	GRGUREVIC LEA		CRO - CROATIA
5	QUINTERO FLORES GEOMARA		MEX - MEXICO
7	DIAZ SOFIA		CRC - COSTA RICA
7	MAZARIEGOS IGLESIAS IRENE		ESP - SPAIN

Junior Kumite Female 66+ kg			
1	FRY AUTUMN		ENG - ENGLAND
2	ETTALEB MERIAME		TUN - TUNISIA
3	MORENO AMANDA		CRC - COSTA RICA
3	SOTO SEPULVEDA MARTINA IGNACIA		CHI - CHILE
5	HOLLYBOW ANIKA		CAN - CANADA

Junior Kumite Male -55 kg			
1	CRUZ ROMERO DANIEL ALEJANDRO		MEX - MEXICO



Official Results

2	HERMOSILLA KIRSTEN CRISTOBAL		CHI - CHILE	
3	OCHOA KEN		USA - UNITED STATES	
3	RATHNAYAKE HELITHA		CAN - CANADA	
5	AGUILERA MARTIN		CHI - CHILE	
5	FREGOSO SUINAGA IKER		MEX - MEXICO	
7	FLORENTIN IVAN		PAR - PARAGUAY	
7	MONTAÑES ADORNO ARTURO ANDRES		PUR - PUERTO RICO	

Junior Kumite Male -61 kg

1	NACU MATEO		USA - UNITED STATES	
2	LOPEZ ZACK		USA - UNITED STATES	
3	KARRAS PETROS		GRE - GREECE	
3	MABIĆ FILIP		CRO - CROATIA	
5	RODRIGUEZ DANIEL		CRC - COSTA RICA	
5	TOLEDO SEBASTIAN		COL - COLOMBIA	
7	BOHORQUEZ CAUSIL JOSE LUIS		COL - COLOMBIA	
7	BLUNCK AUGUST		USA - UNITED STATES	
9	VELAZQUEZ OSUNA SERGIO EDUARDO		MEX - MEXICO	
9	LEE CHRISTOPHER		CAN - CANADA	

Junior Kumite Male -68 kg

1	CORAO LUIS		USA - UNITED STATES	
2	HELLER BEN		GER - GERMANY	
3	TONIOLO ALVISE		ITA - ITALY	
3	PAVEZ ALONSO		CHI - CHILE	
5	PLATISA PASCAL		AUT - AUSTRIA	
5	LORENZ SWAN		SUI - SWITZERLAND	
7	SANCHEZ DARDO		PAR - PARAGUAY	
7	ADRIAZOLA REYES BENJAMIN		CHI - CHILE	
9	THIERBACH LUCA		GER - GERMANY	

Junior Kumite Male -76 kg

1	STRAHIJA SVEN		CRO - CROATIA	
2	WOOD LANDEN		USA - UNITED STATES	
3	LEAL MORENO IKER		ESP - SPAIN	
3	PEÑA RENATO		CHI - CHILE	
5	ZUNIGA SPÄTHE ROBIN MATEO		GER - GERMANY	
5	SANDOVAL SANDOVAL JOSE ANTONIO		MEX - MEXICO	
7	MORALES SERRANO GERSHON ADIR		GUA - GUATEMALA	
7	ORTEGA DESCIDERIO ANGEL JOSUE		MEX - MEXICO	
9	SANCHEZ MONTENEGRO RUBEN		MEX - MEXICO	

Junior Kumite Male 76+ kg

1	GONDI NIKOLA		CRO - CROATIA	
2	SELIMOVIC ARMIN		AUT - AUSTRIA	
3	MOLINERO MICHAEL		USA - UNITED STATES	
3	RUIZ RUIZ JOSÉ LUIS		ESP - SPAIN	



Official Results

5	MIRESAN SECHEI CRISTIAN ALEXANDRU		ESP - SPAIN	
5	GARZA CHAVARRIA FRANCISCO DEMIAN		MEX - MEXICO	
7	MORENO FLORES GUILLERMO ZABDIEL		MEX - MEXICO	
7	GÁLVEZ TAMAYO VICENTE CRISTÓBAL		CHI - CHILE	

U14 Kata Female

1	NGUYEN KATELYN		USA - UNITED STATES	
2	SCHEDDEL KAENA		SUI - SWITZERLAND	
3	RASHIDI LILY		USA - UNITED STATES	
3	ANDREEVSKI KALINA		USA - UNITED STATES	
5	SOLOMON ALANA		CRC - COSTA RICA	
5	SHAHNAZ LAJWERD		USA - UNITED STATES	
7	GARZA VIZCAINO MARIA VICTORIA		MEX - MEXICO	
7	PEREZ GONZALEZ NAHOMI DAYANA		MEX - MEXICO	

U14 Kata Male

1	ZADINA EMIL		AUT - AUSTRIA	
2	VERCIMAK MARTIN		SVK - SLOVAKIA	
3	CASTRO LÓPEZ BRAULIO		ESP - SPAIN	
3	MUGA SHAMUEL		VEN - VENEZUELA	
5	BONETTI AKIAU LUIGI		USA - UNITED STATES	
5	GONZALES MOISES		CRC - COSTA RICA	
7	GUNJA KARIM		CAN - CANADA	
7	SANCHEZ LUIS		USA - UNITED STATES	
9	DISLA JOSE		DOM - DOMINICAN REPUBLIC	
9	DELGADO SANCHEZ SAUL ALEJANDRO		MEX - MEXICO	

U14 Kumite Female -42 kg

1	PEREZ SALAMANCA NATALIA		COL - COLOMBIA	
2	SHAHNAZ LAJWERD		USA - UNITED STATES	
3	VALDERRAMA ALVAREZ FERNANDA AMARAL		CHI - CHILE	
3	BEN RABEH ALIYA		FRA - FRANCE	
5	ANDREEVSKI KALINA		USA - UNITED STATES	
5	GILL SEREYA		CAN - CANADA	

U14 Kumite Female -47 kg

1	BALINT ELINA		USA - UNITED STATES	
2	MADDEN LEIA-SUMMER		MLT - MALTA	
3	OLSCHESKI HANNA		GER - GERMANY	
3	RATHNAYAKE MUTHULI		CAN - CANADA	
5	VÁSQUEZ PEÑA ASTRID		PER - PERU	
5	SOLOMON ALANA		CRC - COSTA RICA	
7	HERNANDEZ QUIROZ ROBERTA		MEX - MEXICO	

U14 Kumite Female -52 kg

1	MELGAR POSTIGO JULIA MARIA		ESP - SPAIN	
2	ARCALEAN MIHAELA		USA - UNITED STATES	



Official Results

3	HERNANDEZ YANEZ FRIDA NICOLE		MEX - MEXICO	
3	FÖRSTER ALEXIA		GER - GERMANY	
5	VEGA BUSTAMANTE AMANDA		CHI - CHILE	
5	RIVERA RODRIGUEZ JADE GETSEMANI		MEX - MEXICO	
7	LA SERNA HILARIO GRECIA BEATRIZ		PER - PERU	

U14 Kumite Female 52+ kg

1	NGUYEN KATELYN		USA - UNITED STATES	
2	ANTIPA GONZALEZ MAILEN		CHI - CHILE	
3	AROS REBOLLEDO EMILIA		CHI - CHILE	
3	HOERNER FRIEDA		GER - GERMANY	
5	FRIAS CABRAL MELINA		MEX - MEXICO	
5	HANDLEY SKYLA		ENG - ENGLAND	

U14 Kumite Male +55 kg

1	PAGIN LUKASZ		GER - GERMANY	
2	AZADI BIJAN		GER - GERMANY	
3	OUSMANE NIANG		USA - UNITED STATES	
3	HONORIO VELASCO ALVARO MANUEL		PER - PERU	
5	GARCIA RÓCHA JOSE LUIS		MEX - MEXICO	
5	OLIVAS ROMERO PABLO ANTONIO		MEX - MEXICO	
7	HERNANDEZ NAVARRO MATHIAS		CHI - CHILE	
7	IGNACIO RIOS		VEN - VENEZUELA	

U14 Kumite Male -40 kg

1	GONZALES MOISES		CRC - COSTA RICA	
2	BOJORQUEZ ARCE BRANDON VLADIMIR		MEX - MEXICO	
3	ROBLES CASTRO CARLOS KALEB		MEX - MEXICO	
3	PEREZ KASUGA MARIO ALBERTO SHINJI		MEX - MEXICO	
5	SHAIKH AARIZ		USA - UNITED STATES	
5	HOBSON CHASE		CAN - CANADA	

U14 Kumite Male -45 kg

1	SOTOMAYOR VILLAROEEL BENJAMIN		CHI - CHILE	
2	BAHAMONDE AGUSTIN		CHI - CHILE	
3	SEKOU BEN STEPHAN TIMITE		USA - UNITED STATES	
3	GRÜNELT OLIVER		GER - GERMANY	
5	BONETTI AKIAU LUIGI		USA - UNITED STATES	
5	SATTANATHAN SIVANANDH		USA - UNITED STATES	
7	D FLON VASQUEZ KAILASH TARIK		MEX - MEXICO	
7	SANCHEZ LUIS		USA - UNITED STATES	

U14 Kumite Male -50 kg

1	FERRARIS GIACOMO		ITA - ITALY	
2	JIMENEZ NICOLAS		CRC - COSTA RICA	
3	CONTRERAS ORTIZ LUCAS		CHI - CHILE	
3	MIRALLES PINEDA MATEO		CHI - CHILE	



Official Results

5	VILLALOBOS JUAN CAMILO		CRC - COSTA RICA	
5	SINGH EVAN		CAN - CANADA	
7	OROZCO TORRES JOSE HUMBERTO		MEX - MEXICO	
7	GIL GONZALEZ PATRICIO		MEX - MEXICO	

U14 Kumite Male -55 kg

1	VELAZQUEZ OSUNA OLIVER LEONARDO		MEX - MEXICO	
2	CCOILLO FERRANTE ADRIANO TADEO		PER - PERU	
3	CHAVEZ RAMIREZ GERARDO GABRIEL		MEX - MEXICO	
3	DELGADO SANCHEZ SAUL ALEJANDRO		MEX - MEXICO	
5	ACOSTA PARICIO TOMAS		MEX - MEXICO	
5	PEREZ MENDEZ FRANCISCO DANIEL		MEX - MEXICO	

U21 Kata Female

1	CARDOSO MARIA		POR - PORTUGAL	
2	CASTAÑO ROJO LEIDY DANIELA		COL - COLOMBIA	
3	VALDIVIA MONZON ALEXANDRA SOFIA		PER - PERU	
3	MARTINS RITA		POR - PORTUGAL	
5	KUDSI MASA		CAN - CANADA	
5	WILLIAMS DANNI		ENG - ENGLAND	
7	BISSOLI FERRI KUSTER AMANDA		BRA - BRAZIL	
7	RUIZ CAMILA		CRC - COSTA RICA	
9	DENA ALVAREZ JOANA MARÍA		MEX - MEXICO	

U21 Kata Male

1	HOFFMANN LUCAS		FRA - FRANCE	
2	CALDERON FERNANDO		GUA - GUATEMALA	
3	MATACCHIONI LUIGI		ITA - ITALY	
3	ŠTAHLAVSKÝ ONDŘEJ		CZE - CZECH REPUBLIC	
5	KWOK HO HIM		HKG - HONG KONG, CHINA	
5	HIGUCHI KEN		PER - PERU	
7	DARVEAU OLIVIER		CAN - CANADA	
7	PAEZ JOAQUIN		ECU - ECUADOR	
9	URDANETA VALENCIA ALBERTO		CHI - CHILE	

U21 Kumite Female -50 kg

1	SALINAS HERNANDEZ EMILIA		MEX - MEXICO	
2	YALCIN SAMINA		NED - NETHERLANDS	
3	ORANTES MAGANA SOFIA ALEJANDRA		ESA - EL SALVADOR	
3	CARRILLO URDIALES CINTHIA RUBI		MEX - MEXICO	
5	EACHEVERRIA VEGA BELÉN ANTONIA ALEXANDRA		CHI - CHILE	
5	LEIVA GAETE MAIRA		CHI - CHILE	

U21 Kumite Female -55 kg

1	GODOY MAGDALENA		CHI - CHILE	
2	HERRERA AYALA ANA CAROLINA		MEX - MEXICO	



Karate1 Youth League - Cancun 2024 - 2024-08-08



Official Results

3	REGLAR EMILY		CAN - CANADA	
3	EJJA IMAN		BEL - BELGIUM	
5	GARCIA PACHECO REGINA ESTELA		MEX - MEXICO	
5	GOMEZ BUITRAGO MARIA JOSE		COL - COLOMBIA	
7	FLORES RAMOS HAZEL SAMEIDY		ESA - EL SALVADOR	

U21 Kumite Female -61 kg

1	CRIOU EVA		POL - POLAND	
2	AGUDELO MARIN MARIA ALEJANDRA		COL - COLOMBIA	
3	CACKO MIA		CRO - CROATIA	
3	LAWRANCE SOPHIE		CAN - CANADA	
5	SAAVEDRA AGUIRRE VALERIA		MEX - MEXICO	
5	LOPEZ SERRATOS KATIA DANIELA		MEX - MEXICO	
7	VERGARA RAMÍREZ MARTINA ISIDORA		CHI - CHILE	

U21 Kumite Female -68 kg

1	PALENCIA LUISA		GUA - GUATEMALA	
2	MENDEZ MAYEN ALONDRA ELIZABETH		MEX - MEXICO	
3	QUINTERO AVAS CIELO		MEX - MEXICO	
3	PERALTA MARCO JOSÉ IGNACIA		CHI - CHILE	
5	SORIA ESQUIVEL ANA SOFIA		MEX - MEXICO	

U21 Kumite Female 68+ kg

1	ALLSOPP AMBER		ENG - ENGLAND	
2	MUZIK TAŠA MAU		SLO - SLOVENIA	
3	GUARIN SOFIA		COL - COLOMBIA	
3	SCHUETZE EMMA		AUT - AUSTRIA	
5	HONORIO VELASCO DORIS FABIANA		PER - PERU	
5	JENNINGS DESTINY		USA - UNITED STATES	

U21 Kumite Male -60 kg

1	DORTA JANCO		USA - UNITED STATES	
2	CRUZ KEVIN		USA - UNITED STATES	
3	OLIVEIRA GUSTAVO		POR - PORTUGAL	
3	MAINGUEZ NOGUERA JUAN CAMILO		COL - COLOMBIA	
5	PASTRANA SANTANA JORDI JOSE		COL - COLOMBIA	
5	DOLINYAN DAVIT		USA - UNITED STATES	
7	GALLARDO JUAN IGNACIO		ARG - ARGENTINA	
7	BAUTISTA ESTEBAN		MEX - MEXICO	

U21 Kumite Male -67 kg

1	ALVES RAFAEL		POR - PORTUGAL	
2	GONÇALVES GUILHERME		POR - PORTUGAL	
3	VIDEGARAY PEREZ PATRICIO		MEX - MEXICO	
3	DZIUDA DOMINIK		POL - POLAND	
5	TORRES STEVEN		SUI - SWITZERLAND	
5	GAMEZ GIAN		VEN - VENEZUELA	



Karate1 Youth League - Cancun 2024 - 2024-08-08



Official Results

7	BAENA TAMAYO MATEO		COL - COLOMBIA	
7	YOSHII MIZUKAMI HIROTO JAVIER		MEX - MEXICO	

U21 Kumite Male -75 kg

1	FERNANDES BERNARDO PINEU		POR - PORTUGAL	
2	INACIO DIOGO		POR - PORTUGAL	
3	GOMEZ TOBON JOSE DAVID		COL - COLOMBIA	
3	YOSHII MIZUKAMI HAYATO FRANCISCO		MEX - MEXICO	
5	CORBIN JOSHUA		USA - UNITED STATES	
5	ŠTÁHLAVSKÝ ONDŘEJ		CZE - CZECH REPUBLIC	
7	GUTIERREZ MADRIGAL KAROL DANIEL		MEX - MEXICO	
7	GONÇALVES NEGRI PEDRO		BRA - BRAZIL	

U21 Kumite Male -84 kg

1	OSPINA SOSCUE SANTIAGO		COL - COLOMBIA	
2	HALLDÓRSSON HUGI		ISL - ICELAND	
3	METS MIHKEL		EST - ESTONIA	
3	BUKA YAN		USA - UNITED STATES	
5	CARAVANTES MONTOYA ARIF ENRIQUE		MEX - MEXICO	
5	GARCIA MONTT JOSE EMILIANO		GUA - GUATEMALA	

U21 Kumite Male 84+ kg

1	PADILLA GARCIA ISAAC GAEL		MEX - MEXICO	
2	BRITOS IVAN		PAR - PARAGUAY	
3	VELASCO MARQUEZ ALBERTO		MEX - MEXICO	
3	SANCHEZ MARQUEZ JOAQUIN ADOLFO		VEN - VENEZUELA	
5	WHITE JARED		USA - UNITED STATES	
5	DE LANDA ZISKROUT ISAAC		CAN - CANADA	
7	HERNANDEZ MENESES YOSEPH FERNEY		COL - COLOMBIA	