

RESULTS BOOK

KARATE1 YOUTH LEAGUE - VENICE 2024

2024.12.04 - 2024.12.08

PALAZZO DEL TURISMO, PIAZZA BRESCIA 11, 30016 LIDO DI
JESOLO VE

ITALY, ITA

TABLE OF CONTENTS

NUMBER OF ENTRIES	3
NUMBER OF ENTRIES BY CONTINENT	5
ENTRYLIST	8
STATISTICS	87
CADET KATA FEMALE	89
CADET KATA MALE	105
CADET KUMITE FEMALE -47 KG	121
CADET KUMITE FEMALE -54 KG	132
CADET KUMITE FEMALE -61 KG	143
CADET KUMITE FEMALE 61+ KG	153
CADET KUMITE MALE -52 KG	163
CADET KUMITE MALE -57 KG	174
CADET KUMITE MALE -63 KG	185
CADET KUMITE MALE -70 KG	196
CADET KUMITE MALE 70+ KG	206
JUNIOR KATA FEMALE	216
JUNIOR KATA MALE	232
JUNIOR KUMITE FEMALE -48 KG	248
JUNIOR KUMITE FEMALE -53 KG	258
JUNIOR KUMITE FEMALE -59 KG	268
JUNIOR KUMITE FEMALE -66 KG	278
JUNIOR KUMITE FEMALE 66+ KG	288
JUNIOR KUMITE MALE -55 KG	298
JUNIOR KUMITE MALE -61 KG	308
JUNIOR KUMITE MALE -68 KG	319
JUNIOR KUMITE MALE -76 KG	330
JUNIOR KUMITE MALE 76+ KG	340
U14 KATA FEMALE	352
U14 KATA MALE	363

U14 KUMITE FEMALE -42 KG	374
U14 KUMITE FEMALE -47 KG	385
U14 KUMITE FEMALE -52 KG	396
U14 KUMITE FEMALE 52+ KG	407
U14 KUMITE MALE +55 KG	419
U14 KUMITE MALE -40 KG	429
U14 KUMITE MALE -45 KG	440
U14 KUMITE MALE -50 KG	450
U14 KUMITE MALE -55 KG	460
U21 KATA FEMALE	470
U21 KATA MALE	481
U21 KUMITE FEMALE -50 KG	492
U21 KUMITE FEMALE -55 KG	499
U21 KUMITE FEMALE -61 KG	506
U21 KUMITE FEMALE -68 KG	516
U21 KUMITE FEMALE 68+ KG	524
U21 KUMITE MALE -60 KG	531
U21 KUMITE MALE -67 KG	541
U21 KUMITE MALE -75 KG	551
U21 KUMITE MALE -84 KG	561
U21 KUMITE MALE 84+ KG	571
OFFICIAL RESULTS	581



Karate1 Youth League - Venice 2024

ITALY

2024.12.04 - 2024.12.08

PALAZZO DEL TURISMO, Piazza Brescia 11, 30016 Lido di Jesolo VE



NUMBER OF ENTRIES

#	Code	Country	Male Entries	Female Entries	Total Entries	Total Athletes
1		ALB ALBANIA	1	1	2	2
2		AND ANDORRA	1	5	6	6
3		ARM ARMENIA	12	2	14	14
4		ARU ARUBA	1	0	1	1
5		AUS AUSTRALIA	2	0	2	2
6		AUT AUSTRIA	20	18	38	38
7		AZE AZERBAIJAN	12	4	16	16
8		BAN BANGLADESH	2	0	2	1
9		BEL BELGIUM	43	22	65	64
10		BEN BENIN	2	0	2	2
11		BIH BOSNIA AND HERZEGOVINA	69	77	146	142
12		BRA BRAZIL	2	1	3	3
13		BUL BULGARIA	22	22	44	43
14		CAN CANADA	16	10	26	25
15		CHI CHILE	3	4	7	7
16		TPE CHINESE TAIPEI	3	8	11	11
17		COL COLOMBIA	1	1	2	2
18		CRC COSTA RICA	1	1	2	2
19		CRO CROATIA	75	90	165	165
20		CYP CYPRUS	18	4	22	22
21		CZE CZECH REPUBLIC	58	45	103	102
22		DEN DENMARK	4	9	13	13
23		EGY EGYPT	1	4	5	5
24		ESA EL SALVADOR	0	2	2	2
25		ENG ENGLAND	65	59	124	123
26		FIN FINLAND	3	7	10	10
27		FRA FRANCE	84	80	164	161
28		PYF FRENCH POLYNESIA	0	1	1	1
29		GEO GEORGIA	6	0	6	6
30		GER GERMANY	103	117	220	220
31		GRE GREECE	26	36	62	61
32		HKG HONG KONG, CHINA	8	3	11	11
33		HUN HUNGARY	54	32	86	86
34		ISL ICELAND	1	0	1	1
35		IND INDIA	0	1	1	1
36		IRL IRELAND	4	5	9	9
37		IRI ISLAMIC REPUBLIC OF IRAN	4	6	10	10
38		ITA ITALY	447	347	794	793
39	AIN	AIN-1 Individual Neutral Athletes - 1	1	3	4	4
40	AIN	AIN-2 Individual Neutral Athletes - 2	0	1	1	1
41		JAM JAMAICA	2	0	2	1
42		JPN JAPAN	3	6	9	9
43		KAZ KAZAKHSTAN	1	1	2	2
44		KOS KOSOVO	25	26	51	51
45		KUW KUWAIT	13	1	14	14
46		LAT LATVIA	29	14	43	43



Karate1 Youth League - Venice 2024

ITALY

2024.12.04 - 2024.12.08

PALAZZO DEL TURISMO, Piazza Brescia 11, 30016 Lido di Jesolo VE



NUMBER OF ENTRIES

#	Code	Country	Male Entries	Female Entries	Total Entries	Total Athletes
47		LTU LITHUANIA	0	2	2	2
48		LUX LUXEMBOURG	13	17	30	30
49		MLT MALTA	1	9	10	10
50		MEX MEXICO	1	0	1	1
51		MDA MOLDOVA, REPUBLIC OF	24	10	34	32
52		MNE MONTENEGRO	12	4	16	16
53		MAR MOROCCO	1	0	1	1
54		NED NETHERLANDS	25	14	39	39
55		NCL NEW CALEDONIA	1	1	2	2
56		MKD NORTH MACEDONIA	4	1	5	5
57		NOR NORWAY	9	6	15	15
58		PER PERU	4	5	9	9
59		POL POLAND	72	47	119	115
60		POR PORTUGAL	70	52	122	119
61		KOR REPUBLIC OF KOREA	2	2	4	4
62		ROU ROMANIA	60	56	116	114
63		SCO SCOTLAND	11	5	16	16
64		SEN SENEGAL	1	1	2	2
65		SRB SERBIA	33	49	82	81
66		SVK SLOVAKIA	67	47	114	113
67		SLO SLOVENIA	28	28	56	55
68		ESP SPAIN	62	60	122	110
69		SWE SWEDEN	18	13	31	31
70		SUI SWITZERLAND	34	42	76	73
71		SYR SYRIAN ARAB REPUBLIC	1	1	2	2
72		TTO TRINIDAD AND TOBAGO	0	2	2	2
73		TUN TUNISIA	1	1	2	2
74		TUR TURKIYE	32	33	65	65
75		TKM TURKMENISTAN	19	0	19	17
76		UKR UKRAINE	150	87	237	233
77		USA UNITED STATES	12	5	17	16
78		VEN VENEZUELA	17	4	21	20
79		WAL WALES	1	2	3	3
Totals:			2034	1682	3716	3663



NUMBER OF ENTRIES BY COUNTRY AND CONTINENT



Karate1 Youth League - Venice 2024

As of 8 DEC 2024

Country Code	Continent / Country	Male Entries	Female Entries	Total Entries	Total Athletes
	AFRICA				
BEN	BENIN	2	0	2	2
EGY	EGYPT	1	4	5	5
MAR	MOROCCO	1	0	1	1
SEN	SENEGAL	1	1	2	2
TUN	TUNISIA	1	1	2	2
Total	AFRICA	5	6	12	12
	ASIA				
BAN	BANGLADESH	2	0	2	1
TPE	CHINESE TAIPEI	3	8	11	11
HKG	HONG KONG, CHINA	8	3	11	11
IND	INDIA	0	1	1	1
IRI	ISLAMIC REPUBLIC OF IRAN	4	6	10	10
JPN	JAPAN	3	6	9	9
KAZ	KAZAKHSTAN	1	1	2	2
KUW	KUWAIT	13	1	14	14
KOR	REPUBLIC OF KOREA	2	2	4	4
SYR	SYRIAN ARAB REPUBLIC	1	1	2	2
TKM	TURKMENISTAN	19	0	19	17
Total	ASIA	11	29	85	82
	EUROPE				
ALB	ALBANIA	1	1	2	2
AND	ANDORRA	1	5	6	6
ARM	ARMENIA	12	2	14	14
AUT	AUSTRIA	20	18	38	38
AZE	AZERBAIJAN	12	4	16	16
BEL	BELGIUM	43	22	65	64
BIH	BOSNIA AND HERZEGOVINA	69	77	146	142
BUL	BULGARIA	22	22	44	43
CRO	CROATIA	75	90	165	165
CYP	CYPRUS	18	4	22	22
CZE	CZECH REPUBLIC	58	45	103	102
DEN	DENMARK	4	9	13	13
ENG	ENGLAND	65	59	124	123
FIN	FINLAND	3	7	10	10
FRA	FRANCE	84	80	164	161
GEO	GEORGIA	6	0	6	6
GER	GERMANY	103	117	220	220



NUMBER OF ENTRIES BY COUNTRY AND CONTINENT



Karate1 Youth League - Venice 2024

As of 8 DEC 2024

Country Code	Continent / Country	Male Entries	Female Entries	Total Entries	Total Athletes
GRE	GREECE	26	36	62	61
HUN	HUNGARY	54	32	86	86
ISL	ICELAND	1	0	1	1
IRL	IRELAND	4	5	9	9
ITA	ITALY	447	347	794	793
KOS	KOSOVO	25	26	51	51
LAT	LATVIA	29	14	43	43
LTU	LITHUANIA	0	2	2	2
LUX	LUXEMBOURG	13	17	30	30
MLT	MALTA	1	9	10	10
MDA	MOLDOVA, REPUBLIC OF	24	10	34	32
MNE	MONTENEGRO	12	4	16	16
NED	NETHERLANDS	25	14	39	39
MKD	NORTH MACEDONIA	4	1	5	5
NOR	NORWAY	9	6	15	15
POL	POLAND	72	47	119	115
POR	PORTUGAL	70	52	122	119
ROU	ROMANIA	60	56	116	114
SCO	SCOTLAND	11	5	16	16
SRB	SERBIA	33	49	82	81
SVK	SLOVAKIA	67	47	114	113
SLO	SLOVENIA	28	28	56	55
ESP	SPAIN	62	60	122	110
SWE	SWEDEN	18	13	31	31
SUI	SWITZERLAND	34	42	76	73
TUR	TURKIYE	32	33	65	65
UKR	UKRAINE	150	87	237	233
WAL	WALES	1	2	3	3
Total	EUROPE	45	1,908	3,514	3,468
	OCEANIA				
AUS	AUSTRALIA	2	0	2	2
NCL	NEW CALEDONIA	1	1	2	2
Total	OCEANIA	2	3	4	4
	PAN AMERICA				
ARU	ARUBA	1	0	1	1
BRA	BRAZIL	2	1	3	3
CAN	CANADA	16	10	26	25
CHI	CHILE	3	4	7	7



NUMBER OF ENTRIES BY COUNTRY AND CONTINENT



Karate1 Youth League - Venice 2024

As of 8 DEC 2024

Country Code	Continent / Country	Male Entries	Female Entries	Total Entries	Total Athletes
COL	COLOMBIA	1	1	2	2
CRC	COSTA RICA	1	1	2	2
ESA	EL SALVADOR	0	2	2	2
JAM	JAMAICA	2	0	2	1
MEX	MEXICO	1	0	1	1
PER	PERU	4	5	9	9
TTO	TRINIDAD AND TOBAGO	0	2	2	2
USA	UNITED STATES	12	5	17	16
VEN	VENEZUELA	17	4	21	20
Total	PAN AMERICA	13	60	95	91
PYF	FRENCH POLYNESIA	0	1	1	1
AIN-1	INDIVIDUAL NEUTRAL ATHLETES - 1	1	3	4	4
AIN-2	INDIVIDUAL NEUTRAL ATHLETES - 2	0	1	1	1
Total		3	5	6	6
Total		79	2,034	3,716	3,663



Karate1 Youth League - Venice 2024



ENTRIES BY NATIONAL FEDERATION

As of 8 DEC 2024

Country Code	ID	Gender	Name	Event	Seed
ALB	ALB2221	M	PJETRI ERNIK	Junior Kumite Male -68 kg	
	ALB2138	F	BACKA XHEJDAH	Junior Kumite Female -48 kg	
AND	AND02229	M	DE LUCA SOARES DAVID	Junior Kumite Male -68 kg	
	AND2154	F	BEAL BARROS SARA	Cadet Kata Female	
	AND02227	F	GONZALEZ GOMEZ PAULA	Junior Kumite Female -48 kg	
	AND002257	F	PADILLA AINA	Cadet Kumite Female -47 kg	
	AND2153	F	UBIERGO ALAMAN MARIA	Cadet Kata Female	
	AND02228	F	VEGA STRAKY LOLA	Junior Kumite Female -59 kg	
ARM		M	Danielyan Edmond	U14 Kumite Male -50 kg	
	ARM02709	M	GEVORGYAN ALEN	Junior Kumite Male -55 kg	
	ARM003057	M	GOR SHAMIRYAN	U14 Kumite Male -40 kg	
	ARM02373	M	GRIGORYAN ALEN	Cadet Kumite Male -52 kg	
	ARM02967	M	GRIGORYAN SUREN	Junior Kumite Male -61 kg	
	ARM003062	M	HAKOBYAN GEVORG	Junior Kumite Male -55 kg	
	ARM2142	M	HARUTYUNYAN SUREN	U21 Kumite Male -67 kg	
	ARM02961	M	KIRAKOSYAN ARSEN	U14 Kumite Male -40 kg	
	ARM03008	M	KOSAKYAN SUREN	Junior Kumite Male -76 kg	
		M	MAKYAN DANIEL	Cadet Kumite Male -70 kg	
	ARM003060	M	SARGSYAN BAGRAT	U14 Kumite Male -55 kg	
	ARM003056	M	SARGSYAN MIKAYEL	Junior Kumite Male -68 kg	
		F	Harutyunyan Kamila	Junior Kumite Female -59 kg	
	ARM003064	F	HARUTYUNYAN NANE	U14 Kumite Female -52 kg	
ARU		M	PRADA SUNCO KEVEN	U21 Kumite Male -67 kg	
AUS	AUS02740	M	JAHIU DARDAN	U14 Kumite Male +55 kg	
	AUS003076	M	UKPERAJ REGIS	Cadet Kumite Male 70+ kg	
AUT		M	BLAGA ALEXANDRU	U14 Kumite Male -45 kg	
		M	Debro Jakob	Junior Kumite Male -76 kg	
		M	Ebner Fabio	U14 Kumite Male -40 kg	
		M	Fleisch Tobias	Junior Kumite Male -68 kg	
		M	Kleinekathöfer Jakob	U21 Kumite Male -84 kg	
	AUT02530	M	Kleinekathöfer Vincent	U21 Kumite Male 84+ kg	
	AUT02527	M	Kühnel Henrik	U21 Kumite Male -84 kg	
	AUT02480	M	Lang Marcus	U21 Kumite Male -60 kg	
	AUT030000	M	List Fabio	Cadet Kata Male	
		M	Mayr Werner	Junior Kumite Male 76+ kg	
	AUT02781	M	Platisa Pascal	Junior Kumite Male -76 kg	
		M	Sakanovic Adin	Junior Kumite Male -61 kg	
	AUT003121	M	Schnetzer Eric	U14 Kumite Male -50 kg	
	AUT02528	M	SELIMOVIC ARMIN	Junior Kumite Male 76+ kg	
	AUT003120	M	Wagner Emil	Junior Kata Male	
	AUT02673	M	Wagner Felix	U21 Kata Male	
	M	Wintersperger Lorenz	Junior Kumite Male -61 kg		
AUT02533	M	WU TIMON	Junior Kata Male		
AUT02955	M	ZADINA EMIL	U14 Kata Male		
AUT02600	M	ZOECHLING FLORIAN	U21 Kata Male		



Karate1 Youth League - Venice 2024



ENTRIES BY NATIONAL FEDERATION

As of 8 DEC 2024

Country Code	ID	Gender	Name	Event	Seed
AUT	AUT02964	F	Bayram Ceylin	Cadet Kumite Female 61+ kg	
	AUT03047	F	Bayram Mira	U14 Kumite Female -47 kg	
	AUT02817	F	CETIN CEYLIN	Junior Kumite Female -59 kg	
		F	Greif Aurelia	Cadet Kumite Female -54 kg	
	AUT03005	F	KEMETINGER SARAH	Cadet Kumite Female 61+ kg	
	AUT03002	F	KIRISITS MIRA	Cadet Kumite Female -47 kg	
	AUT02966	F	KOVACEVIC LEONI	Cadet Kumite Female -61 kg	
		F	Lehner Leonie	Junior Kumite Female -66 kg	
	AUT02674	F	LEHNER TAMARA	Cadet Kata Female	
	AUT03046	F	Maly Riana	Junior Kata Female	
		F	Sakanovic Adna	Cadet Kumite Female -54 kg	
	AUT02960	F	Sandholzer Maya	U14 Kumite Female 52+ kg	
		F	Schneeweiss Esther	U14 Kata Female	
	AUT02524	F	SCHUETZE EMMA	U21 Kumite Female 68+ kg	
	AUT02677	F	Skrijelj Sara	U21 Kumite Female -61 kg	
	AUT02961	F	Sopic Noemi	U14 Kumite Female -52 kg	
		F	Strodl Sophie	U14 Kata Female	
		F	Treun Elena	U14 Kata Female	
AZE	AZE003404	M	AGIL RZAYEV	Junior Kumite Male -55 kg	
	AZE003413	M	AHMADZADA ISMAYIL	Cadet Kumite Male -52 kg	
	AZE003416	M	AHMADZADA YUSIF	U14 Kumite Male -55 kg	
	AZE02344	M	GANBAROV VUSAL	Cadet Kumite Male -52 kg	
	AZE02700	M	GAYIBOV JAHANGIR	Junior Kumite Male -76 kg	
	AZE003403	M	JAFARLI MAHYADDIN	Cadet Kumite Male -63 kg	
	AZE02347	M	KARIMLI NIJAT	U21 Kumite Male -75 kg	
	AZE02554	M	KARIMZADA NIHAD	U21 Kumite Male 84+ kg	
	AZE03311	M	SALIMLI ELMADDIN	U14 Kumite Male -45 kg	
	AZE03366	M	SAMADLI UGHUR	Cadet Kumite Male -57 kg	
	AZE02600	M	SEMIKHOV MARAT	U14 Kumite Male +55 kg	
	AZE02549	M	SULEYMANOV RASHID	U21 Kumite Male -75 kg	
	AZE2224	F	KARIMOVA SUADA	U21 Kumite Female -55 kg	
	AZE003417	F	MAHARRAMLI DANIZ	Junior Kumite Female 66+ kg	
	AZE03294	F	MAMMADZADA SARVIN	Cadet Kumite Female -47 kg	
	AZE02736	F	NAKONECHNA OKSANA	U21 Kumite Female -61 kg	
BAN	BAN002622	M	CHOUDHURY MAHEEN ADAM	Cadet Kata Male	
	BAN002622	M	CHOUDHURY MAHEEN ADAM	Cadet Kumite Male -52 kg	
BEL	BEL02291	M	ABDELMALKI AMIN	U21 Kumite Male -60 kg	
		M	Abdelmalki Youssef	Junior Kumite Male -55 kg	
	BEL02532	M	ALVES TORCATO MATHIS	Junior Kumite Male -55 kg	
	BEL02521	M	ANISIMOV VLADISLAV	Junior Kumite Male 76+ kg	
		M	Boscolo Nathan	Cadet Kumite Male -52 kg	
		M	Bourlard Lenny	Cadet Kumite Male -70 kg	
		M	Chakhter Amin	U14 Kumite Male +55 kg	
		M	Degée Louis	U14 Kata Male	
		M	Degée Louis	U14 Kumite Male -40 kg	
M		Dernoncourt Sofiane	U14 Kumite Male -40 kg		



Karate1 Youth League - Venice 2024



ENTRIES BY NATIONAL FEDERATION

As of 8 DEC 2024

Country Code	ID	Gender	Name	Event	Seed	
BEL	BEL02529	M	Ejja Amine	U21 Kumite Male -67 kg		
		M	El aalili Ali	U21 Kumite Male -60 kg		
		M	El Aidi Yahya	Junior Kumite Male -76 kg		
		M	Es-Salehy Ismail	U14 Kumite Male -45 kg		
		M	Ghazouani Adam	U14 Kumite Male -45 kg		
	BEL02329	M	ghazouani yassin	U21 Kumite Male -60 kg		
		M	Gilles Boschmans	Cadet Kata Male		
		M	GRANDJEAN HUGO	U14 Kumite Male -40 kg		
	BEL02442	M	Hamoudane Hamza	Cadet Kumite Male -52 kg		
		M	Jaber-Rais Hamza	U21 Kumite Male -67 kg		
		M	Jaber-raïs Ismael	Cadet Kumite Male -63 kg		
	BEL02580	M	Jaber rais Wassim	Junior Kumite Male -76 kg		
		M	JADOUL ERWAN	U21 Kumite Male 84+ kg		
		M	KONRADOWSKI ANDREAS	Cadet Kumite Male -52 kg		
		M	Lazaridis Panagiotis	Cadet Kumite Male 70+ kg		
		M	Mahyou Zayed	U21 Kumite Male -67 kg		
	BEL02440	M	Mehadhebi Amir	U14 Kumite Male -55 kg		
		M	Mrhani Mehdi	Cadet Kumite Male -63 kg		
		M	Palm Lucas	U14 Kumite Male -40 kg		
		M	PANZA ETHAN	U21 Kumite Male -75 kg		
		M	PETRY HUGO	U14 Kumite Male -40 kg		
	SD56394	M	QUARANTA Calogero	Cadet Kumite Male -57 kg		
		M	Roland Nathan	Cadet Kumite Male -52 kg		
		BEL02615	M	Roland Tom	U21 Kumite Male -75 kg	
		BEL02535	M	ROMBEAUX MATT	Junior Kumite Male -61 kg	
			M	Triches Yann	Junior Kumite Male -61 kg	
		M	Tshibassu Elie Christopher	Cadet Kumite Male 70+ kg		
M		Van Den Nieuwenhuijzen Leroy	U21 Kumite Male -67 kg			
M		Van Den Nieuwenhuijzen Vince	U14 Kumite Male -45 kg			
M		Yuksektepe Hamza	U21 Kumite Male -75 kg			
M		Zakhnini Imrane	U14 Kumite Male -40 kg			
BEL02794		M	Zekhnini Achraf	U21 Kumite Male -75 kg		
BEL02528		M	ZOUENI RAYAN	Junior Kumite Male -68 kg		
		F	ANTOINE AURELIE	Junior Kumite Female -66 kg		
BEL02332		F	Bougrine Amel	U21 Kumite Female -61 kg		
BEL02333		F	Bougrine Amina	U21 Kumite Female -68 kg		
BEL02286	F	Dehaes Lena	U21 Kumite Female -50 kg			
	F	Dujardin Eva	U14 Kumite Female -42 kg			
BEL02280	F	Ejja Iman	U21 Kumite Female -55 kg			
BEL02518	F	EL AIDI AYAH	Junior Kumite Female -66 kg			
	F	Hacquin Maëlie	U14 Kumite Female -47 kg			
	F	Hadara Ikram	Cadet Kumite Female -54 kg			
	F	Henroteaux Lou	Junior Kata Female			
	F	Hibrahimi Yasmine	U14 Kumite Female -42 kg			
	F	LENARTZ Maeva	Junior Kata Female			
	BEL02527	F	MAATOUG Nargesse	Junior Kumite Female -66 kg		
	BEL02370	F	MANCA CHIARA	U21 Kata Female		
		F	Mansour Dounya	Junior Kumite Female -59 kg		



Karate1 Youth League - Venice 2024



ENTRIES BY NATIONAL FEDERATION

As of 8 DEC 2024

Country Code	ID	Gender	Name	Event	Seed	
BEL	BEL003217	F	MILER Gelsey	Junior Kata Female		
		F	Poskin Emilie	Cadet Kumite Female -54 kg		
		F	Rejraji Yasmine	Cadet Kumite Female -61 kg		
		F	Sridi Maissa	Cadet Kumite Female 61+ kg		
		F	Swarup Pia	Junior Kumite Female -59 kg		
	SD59682	F	Vervoort Tess	U21 Kumite Female -68 kg		
	BEL02896	F	YUKSEKTEPE ASYA	Junior Kumite Female -48 kg		
BEN	BEN02121	M	ADJANONHOUN IHSANE	Junior Kumite Male 76+ kg		
	BEN02086	M	KPADONOU MARTIAL	U21 Kumite Male -60 kg		
BIH	BIH2669	M	Aljović Sani	Junior Kumite Male -55 kg		
		M	Arnautovic Ali	Junior Kumite Male -68 kg		
		M	Bašić Kemal	Junior Kumite Male -61 kg		
	BIH2179	M	Beganović Taris	Cadet Kata Male		
		M	Bostandzic Anes	U21 Kumite Male 84+ kg		
		M	Busnov Ahmed	Cadet Kumite Male -63 kg		
		M	Džafo Daris	Cadet Kumite Male -57 kg		
		M	Fazlić Nedim	U14 Kumite Male -40 kg		
		M	Gadžo Adis	Cadet Kumite Male -70 kg		
		M	Grabus Bekir	U21 Kumite Male -67 kg		
		M	Gracic Dan	U14 Kumite Male -55 kg		
		M	Gradinčić Vedad	U14 Kumite Male -40 kg		
		BIH03865	M	Halilovic Emir	Junior Kumite Male -61 kg	
			M	Hamzić Hamza	Cadet Kumite Male -63 kg	
			M	Hercegovic Tarik	U14 Kumite Male +55 kg	
			M	Hodžić Adin	U14 Kumite Male +55 kg	
		BIH2817	M	Hodžić Amar	U21 Kumite Male -84 kg	
		BIH03434	M	Ivanic Mile	U21 Kumite Male -84 kg	
		BIH03169	M	Jasarevic Kerim	U21 Kumite Male -60 kg	
		BIH03884	M	Jeličić Nemanja	Junior Kumite Male 76+ kg	
	BIH03435	M	Jovanović Luka MD	U21 Kumite Male -84 kg		
	BIH004860	M	KADRIC FARUK	U21 Kumite Male -60 kg		
		M	Kadrić Muamer	Junior Kumite Male -76 kg		
		M	Karaga Rijad	Cadet Kumite Male -70 kg		
		M	Karaga Zijad	Cadet Kumite Male -70 kg		
		M	Konjhodzic Faris	Junior Kumite Male 76+ kg		
		M	Koprena Filip	Junior Kumite Male 76+ kg		
		M	Lazic Lazar	Cadet Kumite Male -57 kg		
		M	Mešić Arnes	Junior Kumite Male 76+ kg		
		M	Miskiće Elmin	U14 Kata Male		
M		Miskiće Elmin	U14 Kumite Male -55 kg			
M		Mitric Mihajlo	Junior Kumite Male -55 kg			
M		Mosorović Vedad	Cadet Kumite Male 70+ kg			
M		Muhović Davud	U14 Kumite Male -45 kg			
M	Mujić Alen	U21 Kumite Male -60 kg				
M	Mujić Vedad	Junior Kumite Male -61 kg				
M	Mušanović Faris	Junior Kumite Male -76 kg				
M	Neziric Fejsal	Junior Kumite Male -61 kg				



Karate1 Youth League - Venice 2024



ENTRIES BY NATIONAL FEDERATION

As of 8 DEC 2024

Country Code	ID	Gender	Name	Event	Seed
BIH		M	Novicki Aleksandar	U21 Kumite Male -84 kg	
		M	Palić Kenan	U14 Kumite Male -40 kg	
	BIH2455	M	Paljevac Sinan	U21 Kumite Male -75 kg	
		M	Pipal Adi	Junior Kumite Male 76+ kg	
		M	Pipal Tony	U21 Kumite Male 84+ kg	
		M	Rahmanović Imran	Cadet Kumite Male -63 kg	
		M	Rozajac Adin	Junior Kumite Male -68 kg	
		M	Šakinović Adnan	U14 Kata Male	
		M	Šakinović Adnan	U14 Kumite Male +55 kg	
		M	Šarić Loren	U21 Kumite Male -75 kg	
		M	Šečić Hasan	U14 Kumite Male -40 kg	
		M	Selava Ferid	U14 Kumite Male +55 kg	
		M	Selava Husein	Cadet Kumite Male 70+ kg	
	BIH004859	M	Serdar Filip	U14 Kumite Male +55 kg	
		M	SERDAREVIC NEDIM	U21 Kata Male	
		M	Setic Tarik	Junior Kumite Male 76+ kg	
		M	Šiljak Kenan	U21 Kumite Male -60 kg	
		M	Simikic Dusan	Cadet Kumite Male -57 kg	
		M	Smajić Harun	Junior Kumite Male 76+ kg	
		M	Spahic Belmin	Cadet Kumite Male 70+ kg	
		M	Tadić Miloš	U14 Kumite Male -50 kg	
		M	Tanović Anel	U21 Kumite Male 84+ kg	
		M	Vejo Seldin	Junior Kumite Male -55 kg	
	BIH2218	M	Veladžić Senaid	U21 Kata Male	
		M	Vuksan David	U14 Kumite Male +55 kg	
		M	Zolota Ibrahim	U14 Kumite Male -40 kg	
	BIH2823	M	Zolota Ismail	U21 Kumite Male -75 kg	
		M	Zundja Amir	U14 Kumite Male +55 kg	
		M	Zundja Emir	U14 Kumite Male +55 kg	
		M	ĐIDIĆ ISMAIL	Junior Kumite Male -55 kg	
		M	ĐIDIĆ VEDAD	Junior Kumite Male -55 kg	
		F	Ahmetović Tajra	Cadet Kumite Female -47 kg	
		F	Alajbegović Ajna	Cadet Kumite Female -54 kg	
		F	Alibalić Zara	U14 Kata Female	
		F	Alikadić Sajra	U14 Kumite Female 52+ kg	
		F	Arnautović Zahra	U14 Kumite Female -42 kg	
		F	Aščić Šejla	Cadet Kumite Female -61 kg	
		F	Azra Hadzic	U14 Kata Female	
		F	Azra Hadzic	U14 Kumite Female -42 kg	
		F	Babic Mila	U14 Kata Female	
		F	Balić Berina	U14 Kumite Female 52+ kg	
	BIH2818	F	Baraković Medina	U21 Kumite Female -61 kg	
		F	Bašagić Edna	U14 Kata Female	
		F	BEŠIĆ EMA	Junior Kumite Female -53 kg	
		F	Brkanic Amna	U14 Kumite Female -47 kg	
		F	BRKOVIC BERINA	U14 Kumite Female 52+ kg	
		F	Bubalo Nahla	Cadet Kumite Female 61+ kg	
		F	Bukva Ajsa	U14 Kumite Female 52+ kg	



Karate1 Youth League - Venice 2024



ENTRIES BY NATIONAL FEDERATION

As of 8 DEC 2024

Country Code	ID	Gender	Name	Event	Seed
BIH		F	Cokoja Mona	Cadet Kumite Female 61+ kg	
		F	Čurić Berina	Junior Kumite Female 66+ kg	
		F	Fatušić Emina	Cadet Kumite Female -61 kg	
		F	Gegić Zara	Junior Kumite Female -59 kg	
		F	Germić Arza	Cadet Kumite Female 61+ kg	
		F	Goran Hana	U14 Kumite Female 52+ kg	
		F	HASIC DZENITA	Junior Kumite Female -66 kg	
		F	Hodzic Emina	Junior Kumite Female -48 kg	
		F	Hodzic Ismihana	Cadet Kumite Female 61+ kg	
	BIH2596	F	Hodzic Sara	U21 Kumite Female -50 kg	
	BIH03852	F	Hrvat Elmedina	U21 Kumite Female -50 kg	
		F	Husić Dalal	Cadet Kumite Female -61 kg	
		F	Ibrahimović Amna	U14 Kumite Female -47 kg	
		F	Ikanovic Sarah	Cadet Kumite Female -61 kg	
		F	Jakšić Aleksandra	U21 Kumite Female -61 kg	
	BIH03260	F	Jovic Bojana	Junior Kumite Female -59 kg	
		F	Krnetić Jana	U21 Kumite Female -68 kg	
		F	Kurtanović Ajlin	Cadet Kumite Female 61+ kg	
		F	Kurtović Edina	U14 Kumite Female -52 kg	
		F	Maleš Dominika	Junior Kumite Female -66 kg	
		F	Maric Marija	Junior Kumite Female -66 kg	
		F	Marjanovic Kristina	Junior Kumite Female -53 kg	
	BIH03883	F	Markić Lidija	Junior Kumite Female -66 kg	
		F	Matić Ena	Cadet Kumite Female 61+ kg	
		F	Mehanija Hena	Junior Kumite Female -59 kg	
		F	Mehanović Berina	Cadet Kata Female	
		F	Meskovic Ajla	Junior Kumite Female -53 kg	
		F	Mičević Teona	U14 Kumite Female -52 kg	
	BIH2708	F	Muhovic Nadja	U21 Kumite Female 68+ kg	
		F	Muratović Dzejna	Cadet Kumite Female 61+ kg	
		F	Mušinović Ena	U14 Kumite Female -47 kg	
		F	Neziric Sajra	U14 Kumite Female 52+ kg	
		F	Nižol Lana	Cadet Kumite Female -61 kg	
		F	Omanović Henna	U14 Kumite Female 52+ kg	
		F	Omanović Lamija	U14 Kumite Female 52+ kg	
		F	Pašić Mela	Cadet Kumite Female -61 kg	
		F	Pestalić Merjema	U21 Kata Female	
		F	Raščić Zara	U14 Kumite Female 52+ kg	
		F	Rastoder Hena	Junior Kumite Female -53 kg	
		F	Reiz Jasmina	U21 Kata Female	
		F	Reiz Jasmina	U21 Kumite Female -68 kg	
		F	Residbegovic Mubina	U21 Kumite Female -55 kg	
		F	RUDALIJA ŠILA	Junior Kumite Female 66+ kg	
		F	Salihovic Aldijana	Junior Kata Female	
		F	Sarvan Ilma	U14 Kumite Female 52+ kg	
		F	Selman Ajra	Junior Kumite Female 66+ kg	
		F	Šeta Zejneb	Cadet Kumite Female -54 kg	
		F	Šikanjić Jovana	U14 Kumite Female 52+ kg	



Karate1 Youth League - Venice 2024



ENTRIES BY NATIONAL FEDERATION

As of 8 DEC 2024

Country Code	ID	Gender	Name	Event	Seed	
BIH		F	Šiljak Lejla	Cadet Kumite Female -47 kg		
	BIH2604	F	SIPOVIC AJLA	U21 Kumite Female 68+ kg		
	BIH2110	F	SIPOVIC EMINA	U21 Kumite Female -61 kg		
		F	Skenderija-Rašljčić Milica	U14 Kumite Female -52 kg		
	F	Smailovic Lejla	U14 Kata Female			
	F	Softić Ajna	Cadet Kumite Female 61+ kg			
	F	Softić Lamija	Junior Kumite Female -53 kg			
	F	Stanojević Kristina	U21 Kata Female			
	F	Topić Kaja	Junior Kumite Female 66+ kg			
	F	Velagić Hana	Cadet Kumite Female -47 kg			
	F	Zukić Adna	Junior Kumite Female -48 kg			
	F	Zukić Nejra	Junior Kumite Female -48 kg			
	BRA		M	de Oliveira Eduardo	Junior Kumite Male -55 kg	
			M	Tsoy Victor	U14 Kumite Male -50 kg	
		F	Moura Alice	U21 Kumite Female -55 kg		
BUL	BUL02791	M	ANGOV ANGEL	Junior Kata Male		
		M	Atanasov Teodor	Junior Kumite Male 76+ kg		
	BUL02454	M	Georgiev Radoslav	U14 Kumite Male -45 kg		
		M	Ignatov Samuil	U14 Kumite Male -55 kg		
	BUL02454	M	Kateliev Bozhidar	U14 Kumite Male +55 kg		
		M	KOKONOV ROSTISLAV	U14 Kumite Male +55 kg		
	BUL02454	M	Kolev Denislav	U14 Kumite Male -40 kg		
		M	MARKOV GEORGI	U14 Kumite Male -50 kg		
	BUL2139	M	Matuski Georgi	U21 Kata Male		
		M	Mihaylov Petar	Junior Kumite Male -68 kg		
		M	Mihov Martin	Cadet Kumite Male -70 kg		
		M	Nikolov Ivan	Junior Kumite Male -76 kg		
		M	Nikolov Nikola	U14 Kata Male		
		M	Nikolov Nikola	U14 Kumite Male -50 kg		
		M	Sotirov Bojidar	Junior Kumite Male 76+ kg		
		M	Stefanov Aleksandar	U14 Kumite Male -50 kg		
		M	Stefanov Aleksandar	U14 Kumite Male -45 kg		
		M	Stoyanov Andrey	U14 Kumite Male -50 kg		
		BUL003048	M	TANEV IOAN	Cadet Kumite Male -52 kg	
	M		Tsanev Nikolay	Junior Kumite Male -68 kg		
	M		Vakarelov Vladislav	U21 Kumite Male -75 kg		
	M		Vasilev Aleksandar	Junior Kumite Male -76 kg		
	BUL02459	F	ABULIBDE AMIRA	Cadet Kumite Female -61 kg		
		F	BOYADZHIEVA ADRIANA	Cadet Kumite Female -54 kg		
		F	Bratuhceva Danaya	U14 Kumite Female -47 kg		
		F	Dimitrova Daria	Cadet Kumite Female 61+ kg		
		F	Dineva Raya	U14 Kumite Female -47 kg		
		F	Doncheva Gabriela	Cadet Kumite Female -47 kg		
		F	Georgieva Stefani	U14 Kumite Female 52+ kg		
F		Ivanova Deya	U14 Kata Female			
F		Ivanova Tsvetelina	Cadet Kumite Female -61 kg			
F		Kondova Elena	U14 Kumite Female -52 kg			



Karate1 Youth League - Venice 2024



ENTRIES BY NATIONAL FEDERATION

As of 8 DEC 2024

Country Code	ID	Gender	Name	Event	Seed
BUL	BUL02458	F	KOSTOVA VELIZARA	Junior Kata Female	
		F	Nikiforova Plamena	Junior Kumite Female -59 kg	
		F	Nikolova Viktoria	Cadet Kumite Female -47 kg	
	BUL02827	F	PETKOVA MARIELA	U21 Kumite Female -61 kg	
		F	Petkova Viktoria	U14 Kumite Female -52 kg	
		F	Stoimenova Veneta	Junior Kumite Female -59 kg	
		F	Todorova Albena	U14 Kumite Female -52 kg	
	BUL2210	F	Tsaneva Teodora	U21 Kumite Female -50 kg	
		F	Tseryanova Gabriela	Cadet Kumite Female -61 kg	
		F	Yakimova Yana	Cadet Kumite Female -47 kg	
		F	Yordanova Andrea	U14 Kumite Female -42 kg	
		F	Yordanova Raya	U14 Kumite Female -47 kg	
	CAN		M	Ben Tekaya Ahmed	U14 Kumite Male -55 kg
		M	Boulianne Jayden	U14 Kata Male	
		M	Ferjani Yosri	U21 Kumite Male -60 kg	
CAN02874		M	Gruitia Matthew B	Junior Kata Male	
CAN03081		M	HENault EMMANUEL-TADEO	Junior Kumite Male -68 kg	
CAN03062		M	IHAZA SIMON	Junior Kumite Male 76+ kg	
CAN003890		M	KERDOUSSI ABDESSALAM	Junior Kumite Male -68 kg	
		M	Mabrouk Mohamed Younes	U21 Kumite Male -84 kg	
		M	MOKDAD MANAF	Cadet Kumite Male -52 kg	
CAN003936		M	MONGRAIN THEO	Cadet Kumite Male -63 kg	
CAN03073		M	MONGRAIN THIERRY	Junior Kumite Male -76 kg	
		M	MOULOUDJ ANIS	Junior Kumite Male -61 kg	
		M	Oldford Grayson	U14 Kumite Male +55 kg	
CAN003939		M	PALANISAMY ARUN ADIT	U14 Kumite Male -45 kg	
CAN003871		M	SINGH EVAN	Cadet Kumite Male -52 kg	
		M	Till Patrick	Cadet Kata Male	
CAN02675		F	CARTER BROOKLYN	U21 Kata Female	
	F	Delarosa Kiara	Junior Kumite Female -48 kg		
	F	INGALDO ROSALIA	U14 Kumite Female -52 kg		
	F	Lee Amanda	Junior Kata Female		
	F	Lee Amanda	Junior Kumite Female -59 kg		
CAN02672	F	MOKDAD MAROUA	U21 Kumite Female -50 kg		
CAN03647	F	RATHNAYAKE MUTHULI	Cadet Kumite Female -54 kg		
CAN2303	F	REGLAR EMILY	U21 Kumite Female -55 kg		
	F	Singh Adelaide	U14 Kumite Female -42 kg		
	F	Song Dora	Cadet Kata Female		
CHI		M	Codochedo Matias	Cadet Kumite Male 70+ kg	
	CHI003346	M	MATTA SOTO MARTIN ALONSO ANDRES	Cadet Kata Male	
		M	Sotomayor Villaroel Benjamin	U14 Kumite Male -40 kg	
	CHI02935	F	BARRIA ALCARAZ ALLIS VIVIANE	Junior Kata Female	
		F	Cerpa Emilia	U14 Kumite Female -52 kg	
CHI02969	F	GATICA MORALES BELEN	U21 Kumite Female -55 kg		
CHI2250	F	GODOY MAGDALENA	U21 Kumite Female -50 kg		
TPE	TPE02734	M	HSU LI-WEI	U21 Kumite Male -60 kg	



Karate1 Youth League - Venice 2024



ENTRIES BY NATIONAL FEDERATION

As of 8 DEC 2024

Country Code	ID	Gender	Name	Event	Seed
TPE	TPE02730	M	LEE WEN-SHENG	U21 Kumite Male -84 kg	
	TPE02805	M	LI JIN-HAN	U21 Kumite Male 84+ kg	
	TPE02416	F	CHAN HSIN-YU	U21 Kumite Female -50 kg	
	TPE02741	F	HSIAO YUN-CHEN	U21 Kumite Female -50 kg	
	TPE02893	F	KU TZU-CHING	Junior Kumite Female -66 kg	
	TPE02736	F	KUO EN-YU	Junior Kata Female	
	TPE02813	F	LIAO YU-TING	Junior Kumite Female -53 kg	
	TPE02743	F	LIN YI-HSUAN	U21 Kumite Female 68+ kg	
	TPE02742	F	PAO YU-HSUN	U21 Kumite Female -61 kg	
	TPE02745	F	TIEN HSIN-ERH	U21 Kumite Female -55 kg	
COL	COL02635	M	LOPEZ GABRIEL	U21 Kata Male	
	COL003104	F	Jaramillo Mariana	Junior Kata Female	
CRC	CRC002631	M	CARDENAS EDUARDO	Junior Kumite Male 76+ kg	
	CRC002715	F	GONZAGA GARCIA DAYANSI	Junior Kumite Female -59 kg	
CRO		M	Babic Borna	Cadet Kumite Male -63 kg	
	CRO03454	M	Bermanec David	Cadet Kumite Male -70 kg	
	CRO03718	M	BIRAC NIKOLA	Cadet Kumite Male -63 kg	
		M	Brozović Arian	U14 Kumite Male -45 kg	
	CRO2864	M	BURSIC LEON	Junior Kumite Male -68 kg	
		M	Crnogaj Teo	U21 Kumite Male -84 kg	
	CRO03057	M	CUTURA TONI	U21 Kumite Male 84+ kg	
		M	Delić Toni	U14 Kumite Male -50 kg	
		M	Dobre Lukas	U14 Kumite Male -55 kg	
	CRO2533	M	DONADIC NINO	U21 Kumite Male -60 kg	
		M	Drazenovic Damian	U21 Kumite Male -60 kg	
		M	Erak Lovro	Junior Kata Male	
		M	Ereš Karlo	Cadet Kumite Male -57 kg	
		M	FAIĆ DAVID	Cadet Kata Male	
	CRO2641	M	FILES MARK	Junior Kata Male	
		M	Filipovic David	Cadet Kumite Male -70 kg	
	CRO2634	M	Frank Kristijan	U21 Kumite Male -67 kg	
		M	Gavic Kristian	Junior Kumite Male -61 kg	
	CRO2872	M	GONDI NIKOLA	U21 Kumite Male 84+ kg	
	CRO03422	M	GRGIC OZREN	Cadet Kata Male	
	CRO03015	M	HUIC DINO	U21 Kata Male	
		M	Hulina Vito	Cadet Kumite Male -63 kg	
	SD77170	M	Huzjak Nikola	Junior Kumite Male -76 kg	
	CRO03500	M	JAKOVLJEVIC DINO	Junior Kumite Male -55 kg	
		M	Janjić Franko	Cadet Kumite Male -57 kg	
	SD699953	M	Jeromić Noel	Junior Kumite Male -76 kg	
		M	Karačić Ivan	U14 Kumite Male -50 kg	
	CRO03456	M	KOMARAC FILIP	Cadet Kumite Male -57 kg	
	CRO03384	M	Krsnik Vito	Junior Kata Male	
		M	KRUSLIN SVEN	Junior Kumite Male 76+ kg	
	CRO03014	M	Kukić Ivan	Junior Kata Male	
		M	Kurti Niko	U14 Kumite Male -45 kg	



Karate1 Youth League - Venice 2024



ENTRIES BY NATIONAL FEDERATION

As of 8 DEC 2024

Country Code	ID	Gender	Name	Event	Seed	
CRO		M	Kvesić Viktor	U14 Kumite Male -55 kg		
		M	Laginja Ivan	U14 Kumite Male -50 kg		
		M	Laginja Josip	Cadet Kumite Male 70+ kg		
		M	Leskovar Sven	Cadet Kumite Male -52 kg		
		SD77165	M	Lovrinović David	Cadet Kumite Male 70+ kg	
		SD77168	M	Lukačić Luka	Junior Kumite Male -76 kg	
		CRO2811	M	MABIC FILIP	Junior Kumite Male -61 kg	
			M	Magzan Ivano	Junior Kumite Male -68 kg	
			M	Manestar Petar	Cadet Kumite Male -63 kg	
		CRO03047	M	MATIJEVIC ANTE	Cadet Kumite Male -70 kg	
			M	Matkovic Grga	Cadet Kata Male	
			M	MILIČEVIĆ DOMAGOJ	Cadet Kata Male	
		CRO2525	M	Milinovich David	U21 Kumite Male -75 kg	
		CRO03197	M	NASTESKI MATIJA	U21 Kumite Male -67 kg	
			M	Nedić Leon	U21 Kumite Male -84 kg	
			M	Nekić Stjepan	U14 Kumite Male -40 kg	
		CRO2812	M	Panić Karlo	Junior Kumite Male -76 kg	
		CRO03463	M	PANIC TINO	Cadet Kumite Male -52 kg	
		CRO03461	M	PAPONJA DAVID	Cadet Kumite Male -52 kg	
			M	Penezić Ivano	Junior Kumite Male -68 kg	
		CRO03027	M	Pervan Zeljko	Junior Kumite Male -68 kg	
			M	Pinjuh Bruno	U14 Kumite Male -45 kg	
			M	Piškur Jakov	Cadet Kumite Male -70 kg	
		CRO03130	M	Plesivcak Mislav	U21 Kumite Male 84+ kg	
		CRO2223	M	PRUSINA IVAN NIKO	U21 Kumite Male -75 kg	
		CRO03487	M	Slišković Valentino	Cadet Kumite Male 70+ kg	
		CRO03364	M	SLUKIC PETAR	Cadet Kumite Male -70 kg	
		CRO03489	M	SOLTIC ERVIN	Cadet Kumite Male 70+ kg	
			M	Šonje Dominik	U21 Kumite Male -75 kg	
		CRO2660	M	STRAHIJA SVEN	Junior Kumite Male -76 kg	
			M	Suhina Matej	Junior Kumite Male 76+ kg	
		CRO2122	M	TERIHAIJ IVAN	U21 Kumite Male -84 kg	
		CRO2445	M	TOPLICANEC NIKOLA	U21 Kumite Male -60 kg	
		CRO03139	M	Turkovic Vito	Junior Kumite Male 76+ kg	
		CRO03240	M	Tuškan Sven	Junior Kumite Male -68 kg	
			M	VITELIĆ PAPRIKA TIBOR	U21 Kumite Male -84 kg	
		CRO2708	M	VRANKOVIC MARIO	Junior Kumite Male 76+ kg	
		CRO03966	M	VUCAK DAVID	U14 Kumite Male +55 kg	
			M	Vukoja Lovro	Junior Kumite Male 76+ kg	
		CRO03085	M	Žeinski Ivan	Junior Kata Male	
		CRO03587	M	Zelenika Matko	U21 Kumite Male 84+ kg	
		CRO03084	M	Zeljko Ivan	Cadet Kumite Male -63 kg	
	CRO03036	M	Zeljko Matej	Junior Kumite Male -68 kg		
		F	Adžamić Tena	U14 Kumite Female -42 kg		
	CRO04211	F	BADJUN ANA	Cadet Kata Female		
		F	Bajrić Ajla	U14 Kumite Female -47 kg		
	CRO03016	F	Baric Antonija	Junior Kata Female		
		F	Barukcic Ana Marie	Cadet Kumite Female 61+ kg		



Karate1 Youth League - Venice 2024



ENTRIES BY NATIONAL FEDERATION

As of 8 DEC 2024

Country Code	ID	Gender	Name	Event	Seed
CRO		F	Benić Sara	U21 Kumite Female -61 kg	
	CRO03812	F	BERIŠA TONKA	U21 Kumite Female -50 kg	
	CRO03494	F	BESLIJA ELENA	Cadet Kumite Female -47 kg	
	CRO2827	F	Beslija Nika	U21 Kumite Female -61 kg	
	CRO03381	F	Braica Katja	Junior Kumite Female -59 kg	
		F	BRINC TEA	Junior Kata Female	
	CRO03367	F	BRLETIC ELENA	Cadet Kumite Female -54 kg	
		F	Buinac Tea	Cadet Kumite Female -61 kg	
	CRO03023	F	Bulic Stela	Cadet Kumite Female -47 kg	
		F	Burko Hannan	U21 Kata Female	
	CRO2627	F	Cacko Mia	U21 Kumite Female -61 kg	
		F	Čamber Ivana	Junior Kumite Female -48 kg	
		F	Čebuhar Fani	U14 Kumite Female -42 kg	
		F	Ćorić Lea	Cadet Kumite Female -61 kg	
		F	Čunčić Mia	Cadet Kumite Female -47 kg	
		F	Czerny Guščić Noa	Cadet Kumite Female -61 kg	
	CRO03476	F	DORIC MEDINA	Cadet Kumite Female 61+ kg	
		F	Duduković Nina	Cadet Kumite Female 61+ kg	
		F	Erak Laura	Junior Kata Female	
		F	Fana Era	Cadet Kumite Female -61 kg	
	CRO03378	F	Filković Ema	Junior Kumite Female -66 kg	
		F	Glavina Ana-Marija	Cadet Kumite Female -54 kg	
	CRO2281	F	GRGIC INGA	U21 Kata Female	
		F	Gudelj Lara	Cadet Kata Female	
		F	Horvatović Nikolina	Junior Kata Female	
	CRO2216	F	Ivakovic Lolita Lana	U21 Kumite Female -68 kg	
		F	Jelcic Roza	U14 Kumite Female -47 kg	
		F	Jerkin Franka	U14 Kumite Female -47 kg	
	CRO03733	F	JUKIC EMA	Junior Kumite Female -48 kg	
		F	Jurković Katja	Junior Kumite Female -66 kg	
		F	KARADZA ANA	Junior Kumite Female -59 kg	
	CRO03048	F	KARLOVIC NOELI	Cadet Kumite Female -61 kg	
		F	Kasumovic Natalia	U14 Kumite Female -42 kg	
		F	KATALENAC IVA	Junior Kumite Female -66 kg	
		F	Kincl Nina	U14 Kumite Female -42 kg	
	CRO03382	F	Kirinić Lucija	U21 Kumite Female -50 kg	
	CRO03132	F	KLARIC KORINA	Junior Kumite Female -59 kg	
	CRO03380	F	Kordić Matea	Junior Kumite Female -53 kg	
		F	Krešić Tea	U21 Kumite Female -68 kg	
		F	Krizman Lena	Cadet Kumite Female 61+ kg	
		F	Krmpotić Nika	Junior Kumite Female -66 kg	
		F	Lacković Lucija	Cadet Kata Female	
		F	Ledić Irma	Cadet Kumite Female 61+ kg	
		F	LESJAK TARA	Cadet Kumite Female 61+ kg	
	CRO03373	F	Lovric Mirta	U21 Kumite Female -68 kg	
	CRO03408	F	LUJIC ANA	U21 Kumite Female -55 kg	
		F	Maduna Ivana	U14 Kumite Female -47 kg	
	CRO03396	F	MAGDALENIC PAULINA	Cadet Kumite Female -54 kg	



Karate1 Youth League - Venice 2024



ENTRIES BY NATIONAL FEDERATION

As of 8 DEC 2024

Country Code	ID	Gender	Name	Event	Seed	
CRO	CRO2300	F	MAJSEC ISKRA	U21 Kumite Female -55 kg		
		F	MANDIĆ MARIJA	U21 Kumite Female -68 kg		
	CRO03470	F	Marić Iva	Cadet Kumite Female -54 kg		
		F	Marković Nicole	Cadet Kumite Female -54 kg		
		F	MIKULIĆ BELLA	Junior Kata Female		
		F	Mileta Mare	Cadet Kumite Female -54 kg		
	CRO03732	F	Mirosavljević Nika	Junior Kumite Female -59 kg		
	CRO03588	F	PANIC PAULA	Cadet Kumite Female -61 kg		
		F	Pejnović Alessia	U14 Kumite Female 52+ kg		
	CRO2968	F	Prga Patricija	U21 Kumite Female -55 kg		
		F	Rančić Paola	Cadet Kumite Female -61 kg		
		F	Redžić Jana	Junior Kumite Female -66 kg		
		F	REZIĆ DORA	U21 Kumite Female -55 kg		
		F	Rezo Lea	Junior Kumite Female -66 kg		
		F	Ribar Katarina	U14 Kumite Female -42 kg		
		F	Rogović Lana	Junior Kumite Female -59 kg		
		F	Ross Adriana	U21 Kumite Female -68 kg		
		F	Schubert Dora	U14 Kumite Female -42 kg		
		F	Ščurić Lucija	U14 Kumite Female -42 kg		
		CRO03814	F	SEGAVIC LUCIJA	Junior Kumite Female -66 kg	
			F	Šekuljica Ira	Junior Kumite Female -66 kg	
		CRO2209	F	SGARDELLI EMA	U21 Kumite Female -50 kg	
		CRO03022	F	SIMUNDIC NIKA	Cadet Kumite Female 61+ kg	
	F		SKENDEROVIĆ KATARINA	Junior Kumite Female -59 kg		
	F		Skitarelić Gabi	U14 Kumite Female -47 kg		
	F		Slišković Iva	U14 Kumite Female -52 kg		
	CRO2451	F	SNAJDER DARIJA	U21 Kumite Female -61 kg		
		F	Stojaković Dorotea	Junior Kumite Female -48 kg		
	CRO2818	F	STRAHIJA LAURA	Junior Kumite Female -66 kg		
		F	ŠVIGLIN PAULA	U14 Kata Female		
CRO2841	F	Tadej Sara	Junior Kumite Female -66 kg			
	F	TOMIC SARA	Junior Kumite Female 66+ kg			
CRO2817	F	TRSTENJAK AIDA	Junior Kumite Female -48 kg			
CRO03586	F	Vajda Magdalena	U21 Kumite Female -61 kg			
	F	Validžić Čorić Leona	U14 Kata Female			
	F	Vidović Carla	Cadet Kumite Female -54 kg			
	F	ZAMLIC ZARA MARIE	Cadet Kumite Female -54 kg			
CYP	M	ANASTASIADIS AGGELOS	Cadet Kumite Male -70 kg			
	CYP02938	M	Antoniou Joel	Junior Kumite Male -68 kg		
	CYP02943	M	ANTONIOY NIKOLAS	Junior Kumite Male -68 kg		
		M	CHALOFTIS CHRISTOS	U14 Kumite Male -40 kg		
	CYP02765	M	CHRISTODOULOU MARIOS	U21 Kumite Male -60 kg		
		M	DEMETRIOU ELEFThERIOS	Cadet Kumite Male -70 kg		
	CYP2206	M	GAVRIEL ANDREAS	U21 Kumite Male -60 kg		
	CYP2240	M	GENIAS NICOLAS	U21 Kumite Male -84 kg		
		M	KIOURTZIDIS DIMITRIS	U14 Kumite Male -55 kg		
		M	LOIZOU GIANNIS	Junior Kumite Male -61 kg		



Karate1 Youth League - Venice 2024



ENTRIES BY NATIONAL FEDERATION

As of 8 DEC 2024

Country Code	ID	Gender	Name	Event	Seed
CYP	CYP02831	M	MATSIS NICOLAS	Junior Kumite Male -68 kg	
	CYP2149	M	michael Alex	U21 Kumite Male -75 kg	
		M	NECULAI FLAVIUS LUCIAN	Cadet Kumite Male 70+ kg	
		M	POUMPOURIDIS VALERIOS	U14 Kumite Male -40 kg	
		M	ROUSSOS KYRIACOS	U14 Kumite Male +55 kg	
		M	THEMISTOCLEOUS CHARALAMBOS	Junior Kumite Male 76+ kg	
		M	TINOS ALEXANDROS	Cadet Kumite Male -70 kg	
	CYP2342	M	TSANGARAS ALEXIS	U21 Kumite Male -67 kg	
	CYP02829	F	EFSTATHIOU CONSTANTINA	Junior Kumite Female -48 kg	
		F	KYRIACOU STAVRI	Cadet Kumite Female -54 kg	
		F	Michailidou Philippa	Junior Kumite Female -53 kg	
		F	STYLIANOU KALIA	U14 Kumite Female -42 kg	
CZE	CZE02344	M	BEDNAR ONDREJ	Junior Kumite Male -68 kg	
		M	Benda Karel	U21 Kumite Male -75 kg	
	CZE02265	M	BINA TADEAS	Junior Kumite Male -61 kg	
		M	Brzobohatý Michal	Cadet Kata Male	
	CZE02845	M	Bureš Karel	Junior Kumite Male -68 kg	
		M	Derfl Jan	Junior Kumite Male -61 kg	
		M	DOBROZEMSKÝ Lukáš	Cadet Kumite Male 70+ kg	
	CZE003002	M	DOUBEK JACHYM	U14 Kumite Male -45 kg	
	CZE02481	M	DUB DANIEL	Junior Kumite Male -61 kg	
		M	Endršt Jiří	U21 Kumite Male 84+ kg	
	CZE02491	M	ENEV MARTIN	Cadet Kumite Male -63 kg	
	CZE003003	M	FAJT JAKUB	Cadet Kumite Male -70 kg	
		M	Falion Maxim	Cadet Kumite Male -63 kg	
		M	Foltýn Martin	Cadet Kata Male	
		M	Hampejs Adam	Cadet Kumite Male -57 kg	
	CZE02427	M	HARVILKO SIMON	Junior Kumite Male -61 kg	
		M	Havrda Adam	U14 Kata Male	
		M	Hoffmann Filip	U14 Kumite Male -45 kg	
	CZE02420	M	HORNAK FILIP	Junior Kumite Male -55 kg	
	CZE02712	M	ILCIK ADAM	Cadet Kata Male	
		M	Jindra Daniel	Cadet Kumite Male 70+ kg	
		M	Korch Václav	Cadet Kumite Male -57 kg	
		M	Koupal Martin	U14 Kata Male	
	CZE002930	M	KOUPAL MARTIN	U14 Kumite Male -45 kg	
	CZE02348	M	LINHART JOSEF	Junior Kumite Male -61 kg	
	CZE02723	M	MALY MARCEL	U14 Kumite Male +55 kg	
		M	Matoušek Libor	Cadet Kumite Male -70 kg	
		M	Nedbal Vít	U14 Kata Male	
		M	Nedbal Vít	U14 Kumite Male -55 kg	
		M	Oližbut Tomáš	Cadet Kumite Male -52 kg	
		M	Palan Martin	Cadet Kumite Male 70+ kg	
	CZE02212	M	POHL FILIP	U21 Kata Male	
CZE02441	M	RAUSER ADAM	Junior Kata Male		
CZE02492	M	SIMOTA DAVID	Cadet Kumite Male -57 kg		
	M	Škoudlil David	U14 Kumite Male +55 kg		



Karate1 Youth League - Venice 2024



ENTRIES BY NATIONAL FEDERATION

As of 8 DEC 2024

Country Code	ID	Gender	Name	Event	Seed
CZE		M	Sladký Alexej	U14 Kumite Male -45 kg	
		M	Šnajdr Štěpán	U21 Kumite Male -75 kg	
	CZE02475	M	SNIZEK JIRI	U21 Kumite Male -84 kg	
		M	Šourek Jan	Cadet Kumite Male -70 kg	
		M	Špánik Tobias	Cadet Kumite Male -57 kg	
	CZE02758	M	STAHLAVSKY DAVID	Cadet Kata Male	
	SD54269	M	Šťáhlavský David	Cadet Kumite Male -70 kg	
	CZE02474	M	Šťáhlavský Ondřej	U21 Kumite Male -75 kg	
	CZE02474	M	STAHLAVSKY ONDREJ	U21 Kata Male	
	CZE02422	M	Stránský Jan	U21 Kata Male	
	CZE2169	M	SUKAL VOJTECH	U21 Kata Male	
		M	Šupka Tobiáš	Cadet Kumite Male -63 kg	
	CZE003000	M	SVOBODA SIMON	U14 Kumite Male -40 kg	
		M	Tetour Jan	U14 Kumite Male -50 kg	
		M	Tirala Radek	U21 Kumite Male -75 kg	
		M	Tojšl Filip	U14 Kumite Male -40 kg	
		M	Válek Vojtěch	U21 Kumite Male -84 kg	
		M	Větr Samuel	U14 Kumite Male +55 kg	
		M	Vitasek Lukas	Cadet Kumite Male 70+ kg	
		M	Vrátný Lukáš	Cadet Kata Male	
		M	Vrátný Vojtěch	U21 Kata Male	
		M	Vrecion Tomislav	Cadet Kumite Male -57 kg	
	CZE02259	M	ZLABEK JAKUB	Junior Kata Male	
	CZE02429	F	BIRIUCOVA TAISA	Junior Kata Female	
	CZE02844	F	CIRHANOVA NICOL	U14 Kumite Female -52 kg	
	CZE02248	F	HAKOVA AMALIE	Junior Kumite Female 66+ kg	
		F	Horáková Klára	U14 Kumite Female 52+ kg	
		F	HORŇÁKOVÁ Sofie	U14 Kumite Female -42 kg	
	CZE02268	F	HRDLICKOVA LUCY	Junior Kumite Female -59 kg	
		F	Jůnová Adéla	U21 Kata Female	
	CZE02423	F	KIRSCHNEROVA ALICE-JANA	U21 Kata Female	
	CZE2728	F	Kirschnerová Silvie Ella	Junior Kata Female	
	CZE02479	F	KLEWAROVA MARKETA	Junior Kumite Female -66 kg	
	CZE002999	F	KREPSOVA KATKA	Cadet Kumite Female 61+ kg	
	CZE02535	F	Kubinova Anna	Junior Kata Female	
		F	Kundrátová Lenka	Cadet Kumite Female -54 kg	
		F	Lavičková Nelli	Cadet Kumite Female -54 kg	
	CZE02434	F	MALA DANIELA	Junior Kumite Female -53 kg	
	CZE02610	F	MALAFOVA NATALIE	Junior Kata Female	
		F	Mladkova Anezka	Junior Kumite Female -48 kg	
	CZE02258	F	NOVAKOVA KATERINA	Junior Kumite Female -53 kg	
	CZE02477	F	NOVAKOVA KATERINA	Junior Kata Female	
	CZE02247	F	ONDROUSKOVA AMALIE	U21 Kata Female	
		F	Pavlasová Linda	Junior Kata Female	
		F	Petříková Nathálie	U14 Kumite Female -52 kg	
	CZE02892	F	PETRIKOVA NATHALIE	U14 Kata Female	
	CZE02437	F	POHLOVA EDITA	Cadet Kata Female	
		F	Poskerová Nela	Junior Kumite Female -59 kg	



Karate1 Youth League - Venice 2024



ENTRIES BY NATIONAL FEDERATION

As of 8 DEC 2024

Country Code	ID	Gender	Name	Event	Seed	
CZE	CZE02424	F	PRIGLOVA MARIE	Junior Kumite Female -59 kg		
		F	Sekaninová Viktorie	Cadet Kumite Female 61+ kg		
		F	Ševcová Barbora	U14 Kumite Female -47 kg		
		F	Simpson Liliana	U14 Kumite Female 52+ kg		
	CZE02421	F	STASTNA BARBORA	U21 Kumite Female 68+ kg		
	CZE02421	F	Šťastná Barbora	U21 Kata Female		
	CZE02714	F	STECOVA KATERINA	U21 Kumite Female 68+ kg		
		F	Suchá Dominika	Cadet Kumite Female 61+ kg		
	CZE003001	F	SVOBODOVA ELISKA	U14 Kumite Female 52+ kg		
	CZE02253	F	TINAVSKA EMA	U21 Kumite Female -68 kg		
		F	Troblová Silvie	Cadet Kumite Female 61+ kg		
	CZE2171	F	TRTIKOVA MAGDALENA	U21 Kata Female		
	CZE02250	F	VACHOUTOVA BARBORA	U21 Kata Female		
		F	Vachtová Eva	U14 Kumite Female -52 kg		
		F	Vachtová Věra	Cadet Kumite Female 61+ kg		
		F	Válková Laura	U14 Kumite Female -52 kg		
		CZE02534	F	Veselíková Riana	Junior Kata Female	
			F	Vítů Valentina	Junior Kumite Female -66 kg	
	F		Vodrážková Eliška	Cadet Kumite Female -54 kg		
	F	Vodrážková Nella	Cadet Kumite Female -54 kg			
DEN	DEN02839	M	Kjærgaard Simon Grønlund	Junior Kumite Male 76+ kg		
	DEN02339	M	Linna Mathias Bech	U21 Kumite Male -67 kg		
		M	Mikkelsen Nicolas	U21 Kata Male		
	DEN02842	M	Murakami Petersen Lukas	Cadet Kata Male		
		F	Andersen Emilie Hesselbech	Cadet Kumite Female 61+ kg		
	DEN02466	F	Bath Astamaja	Junior Kumite Female 66+ kg		
		F	Bath Sofia	Junior Kumite Female -48 kg		
		F	Emde Sara	Cadet Kata Female		
		F	Jørgensen Emily	Junior Kumite Female -66 kg		
		F	Kjærsgaard Mathilde	Junior Kumite Female -59 kg		
		F	Nilsson Sara Lønbæk	U21 Kata Female		
	DEN02461	F	Spiegelhauer Chia	U21 Kata Female		
F		Yigit Azra	Junior Kumite Female 66+ kg			
EGY		M	Walid Abdelnaby Ahmed	U21 Kumite Male -75 kg		
		F	Abdou Sally	Junior Kumite Female -59 kg		
	EGY04133	F	AHMED FAYRUZ	Cadet Kata Female		
		F	Ahmed Jasmin	U14 Kata Female		
EGY04475	F	ZAKI Iamar	U14 Kumite Female -42 kg			
ESA	ESA002425	F	CERROS ELENA ISABEL	Junior Kata Female		
	ESA02177	F	ORANTES MAGANA SOFIA ALEJANDRA	U21 Kumite Female -50 kg		
ENG		M	Altham Caolan	Cadet Kata Male		
	ENG02770	M	Attard Zachary	Junior Kumite Male -61 kg		
	ENG02768	M	Baloch Leo	Junior Kumite Male -55 kg		
		M	Barnes Dylan	U21 Kata Male		
		M	Bartoletta Daniel	U21 Kumite Male -67 kg		



Karate1 Youth League - Venice 2024



ENTRIES BY NATIONAL FEDERATION

As of 8 DEC 2024

Country Code	ID	Gender	Name	Event	Seed
ENG		M	Bennett Malachi	Junior Kumite Male -61 kg	
		M	Bennett Malek	Junior Kumite Male -68 kg	
	ENG03251	M	Black Joseph	U21 Kumite Male -60 kg	
		M	Bowen Tai	Junior Kumite Male -76 kg	
		M	Bowron Jaden	U14 Kumite Male -55 kg	
		M	Breeds Henry	U14 Kumite Male +55 kg	
		M	Burden Jonny Rei	U14 Kata Male	
		M	Chandler Keelen John	U14 Kumite Male -45 kg	
		M	Chesterman William	Junior Kumite Male -61 kg	
		M	Clarke - Foulds Riley	Cadet Kumite Male -57 kg	
	SD64200	M	Cooper-Dalley Joseph	U21 Kumite Male -75 kg	
		M	Cutler Jacob	Junior Kumite Male -76 kg	
	ENG02892	M	Darboe Bakary	U21 Kumite Male 84+ kg	
		M	Darnell Alex	Cadet Kumite Male -63 kg	
		M	Dawson Glyn	Junior Kumite Male -76 kg	
		M	Dawson Idris	U21 Kumite Male -75 kg	
		M	Dean Charlie	Junior Kata Male	
		M	Elliot Aiden	Junior Kumite Male -76 kg	
		M	Evans Will	Cadet Kumite Male -63 kg	
		M	Fayik Louie	Cadet Kumite Male 70+ kg	
		M	Fedorov Boris	U21 Kumite Male -75 kg	
		M	Gauci Charlie	U14 Kumite Male -50 kg	
		M	Gill Antonio	Cadet Kumite Male -70 kg	
	ENG02824	M	Giurma-Handley Thomas	U21 Kumite Male -60 kg	
	SD28184	M	Hasib Ameer	Junior Kumite Male -68 kg	
	SD60793	M	Hasib Sameer	Cadet Kumite Male 70+ kg	
		M	Hopkins Freddie	U14 Kata Male	
		M	HOWARD LONDON-JAMES	U14 Kumite Male -40 kg	
		M	Jackson Fenn	U14 Kata Male	
		M	Jurgo Sigitas	Cadet Kumite Male -52 kg	
		M	Langhorn Theo	Cadet Kata Male	
		M	Lokaj Drin	Junior Kumite Male 76+ kg	
	ENG02769	M	Marshall Samuel	U21 Kumite Male -75 kg	
		M	McNaughton Cameron	U14 Kumite Male -55 kg	
	ENG02618	M	Monk Luke	U21 Kumite Male -67 kg	
	ENG02581	M	Moran Jack	U21 Kumite Male -60 kg	
	ENG02826	M	Nastasa Robert	Junior Kata Male	
		M	Newman Zachary	Cadet Kumite Male 70+ kg	
	SD60794	M	Ody Becson	U21 Kumite Male -60 kg	
		M	Oldekop Alex	U14 Kata Male	
		M	Ousey Joe	Cadet Kumite Male -70 kg	
		M	Packford Harry	Junior Kumite Male -68 kg	
		M	Panday Cameron	U21 Kata Male	
	SD60796	M	Patrick Ashton	U21 Kumite Male -84 kg	
		M	Patterson Thomas	Cadet Kumite Male -52 kg	
		M	Paul Syon	Junior Kumite Male -61 kg	
	SD76794	M	Pearce George	U14 Kumite Male -45 kg	
		M	Pratley Jaime	U21 Kata Male	



Karate1 Youth League - Venice 2024



ENTRIES BY NATIONAL FEDERATION

As of 8 DEC 2024

Country Code	ID	Gender	Name	Event	Seed
ENG		M	Rowe Brandon	U21 Kata Male	
		M	Spence Zac	U14 Kata Male	
		M	StClair Malachi	U14 Kumite Male -40 kg	
		M	Taff Charlie	Cadet Kata Male	
	ENG02819	M	Tahov Valentin	Junior Kumite Male -61 kg	
	ENG02777	M	TOUTAYO HUSSEIN	U21 Kumite Male -67 kg	
		M	Voican Yanic	Cadet Kumite Male -52 kg	
		M	Walker James	U21 Kumite Male -75 kg	
		M	WATSTON KAI	Junior Kumite Male -61 kg	
		M	Wells Daniel	Cadet Kumite Male -63 kg	
	ENG02766	M	Wilkins Logan	Junior Kumite Male -68 kg	
		M	Yogarajah Kobe	U21 Kumite Male -60 kg	
	ENG02510	F	Allsopp Amber	U21 Kumite Female 68+ kg	
	ENG011720	F	Anthony Kyla May	Junior Kumite Female -48 kg	
	ENG011725	F	Anthony Shanae Theresa	Junior Kumite Female -53 kg	
		F	Atkiss Gracie	U14 Kumite Female -52 kg	
		F	Attard Sophie	Cadet Kumite Female -61 kg	
	ENG02963	F	Bailey Isabelle	U21 Kumite Female -61 kg	
		F	Baker Aimee	Cadet Kata Female	
		F	Belkadi Joumana	Cadet Kumite Female -61 kg	
		F	Berry Lauren	Cadet Kumite Female -61 kg	
		F	Bilaloglu Firdaous	U14 Kumite Female -47 kg	
		F	Blake Kiana	Cadet Kumite Female -61 kg	
		F	Brewin Erin	Cadet Kata Female	
		F	Carruthers Arabella	Junior Kumite Female -59 kg	
		F	Cartwright Coni-Mae	Junior Kata Female	
		F	Changer Annabel	Cadet Kumite Female -47 kg	
	ENG02772	F	Clow Amelia	U21 Kata Female	
		F	Cutler Sofia	Cadet Kumite Female -54 kg	
		F	Dawson Millie	Junior Kumite Female -59 kg	
		F	Dixon Amy	Junior Kata Female	
	ENG02912	F	Fry Autumn	Junior Kumite Female 66+ kg	
		F	Gallant Rhaea	U14 Kumite Female -52 kg	
		F	Geraghty Jessica	U14 Kata Female	
	ENG02821	F	Giurma-Handley Adela	Junior Kumite Female -48 kg	
	ENG02822	F	Gramaticu Denisa A	U21 Kumite Female -50 kg	
		F	Hambleton Kate	U21 Kumite Female 68+ kg	
		F	HANDLEY SKYLA	U14 Kumite Female 52+ kg	
		F	Harjan Maya-Andreea	Cadet Kumite Female -54 kg	
		F	Hitchcock Freya	Cadet Kumite Female -61 kg	
	ENG02473	F	Holdsworth Eve	U21 Kata Female	
	ENG02473	F	Holdsworth Eve	U21 Kumite Female 68+ kg	
		F	Jenkins Harriet	U14 Kumite Female -52 kg	
	ENG02775	F	Juniper-Smith Ysabel	Junior Kumite Female -66 kg	
		F	Kidd Janelle	Cadet Kata Female	
		F	Kumedzina Myla	U14 Kumite Female 52+ kg	
		F	LANGHORN ELENA	U14 Kata Female	
		F	Leech Freya	Junior Kumite Female 66+ kg	



Karate1 Youth League - Venice 2024



ENTRIES BY NATIONAL FEDERATION

As of 8 DEC 2024

Country Code	ID	Gender	Name	Event	Seed	
ENG	ENG2387	F	Marshall Rebecca	U21 Kumite Female -68 kg		
		F	Melton Lilly	Junior Kata Female		
	SD65919	F	Mepham Emma	Cadet Kumite Female -54 kg		
		F	Nardelli Talia	Junior Kumite Female -59 kg		
	ENG101432	F	Noel Leilani	Junior Kumite Female 66+ kg		
		F	Nurse Ava	Cadet Kata Female		
		F	Nyoni Orianna	Cadet Kumite Female -61 kg		
		F	owusu-agyemang kylah	U14 Kumite Female -47 kg		
		F	Rees Ruby	U21 Kata Female		
		ENG02463	F	Reid Olivia	U21 Kata Female	
			F	Simpson Codi	U14 Kumite Female 52+ kg	
	SD62197	F	SLADE HOLLY	Cadet Kumite Female -54 kg		
		F	SLADE MILLIE	U21 Kumite Female -50 kg		
		F	Slattery Imogen	Cadet Kumite Female -54 kg		
		F	Sou Antonia	U14 Kata Female		
		F	Stoddart Hannah	U14 Kumite Female -42 kg		
		F	Tewley Renee	Junior Kumite Female -66 kg		
		F	Tonks Erin	Junior Kumite Female -59 kg		
		F	Urban Maja	U14 Kumite Female -52 kg		
		F	Walker Shamyra	Cadet Kumite Female 61+ kg		
F		Wegrzyn Nada	Cadet Kata Female			
ENG02901		F	Wyman Jessica-Lee	U21 Kumite Female -68 kg		
	F	Young Rebecca	U21 Kata Female			
FIN	FIN02182	M	Mantere Jimi	Junior Kumite Male 76+ kg		
		M	Takala Akseli	U21 Kata Male		
		M	Wanic Mark	U14 Kata Male		
	FIN02368	F	Kirov Vanessa	Junior Kumite Female 66+ kg		
		F	Koivula Sofia	Junior Kumite Female -66 kg		
	FIN2130	F	Koponen Kiia	U21 Kumite Female -68 kg		
		F	Kuusi Nika	Junior Kata Female		
		F	saadaoui Sonya	U21 Kumite Female -68 kg		
		F	Stefanski Vanessa	U14 Kumite Female -52 kg		
F	Wanic Marie	Cadet Kata Female				
FRA		M	AKGUN Ilhan	U21 Kumite Male 84+ kg		
		M	AKGUN Muhammed Ali	Junior Kumite Male 76+ kg		
		M	Alalou Ilias	U21 Kumite Male -60 kg		
		M	Alves Nathan	Cadet Kumite Male -63 kg		
	SD65740	M	Assemat Hugo	U21 Kumite Male -75 kg		
		M	AYAV Charles	Cadet Kata Male		
	FRA03557	M	BAKAS KENAN	U21 Kumite Male -67 kg		
		M	BELFILALI OTMANE MOHAMED	U14 Kumite Male -40 kg		
		M	Ben fraj Idris	Junior Kumite Male -55 kg		
	FRA03515	M	BITOUN Matthieu	U21 Kata Male		
		M	Blanc Kevin	Junior Kumite Male 76+ kg		
	FRA03295	M	Boisnet Sacha	Junior Kumite Male -68 kg		
		M	BOMPAS JANHAEL	U21 Kata Male		
	SD75768	M	Bordes Evan	Junior Kata Male		



Karate1 Youth League - Venice 2024



ENTRIES BY NATIONAL FEDERATION

As of 8 DEC 2024

Country Code	ID	Gender	Name	Event	Seed
FRA		M	BOUADJEHINE Lazhar	Junior Kumite Male 76+ kg	
		M	Boudriga Bilel	Junior Kumite Male -76 kg	
		M	BOUTELIOUA Sohann	Cadet Kata Male	
		M	BRONDY Joackim	Junior Kata Male	
		M	Bucher Yanis	Junior Kumite Male -55 kg	
	SD67529	M	Bulumac Sergiu	Cadet Kata Male	
	SD77904	M	Casas Nathan	U21 Kata Male	
	FRA03558	M	CHEVALIER MATHIS	U21 Kumite Male -67 kg	
		M	Cissokho Youssouf	Cadet Kumite Male -63 kg	
		M	Col Ahmet Yagiz	Junior Kata Male	
		M	Collin Maé	Cadet Kumite Male -52 kg	
	SD57297	M	Courtois Tom	Junior Kata Male	
		M	Dabi Zakariya	Junior Kumite Male 76+ kg	
		M	dahmani ayoub	Junior Kumite Male -55 kg	
		M	Da Rocha nahel	Cadet Kumite Male 70+ kg	
	SD60798	M	Deberdt Mahé	Cadet Kumite Male -57 kg	
		M	DELAUNAY Damien	Cadet Kumite Male -63 kg	
		M	diallo oumar alpha	Cadet Kumite Male -70 kg	
		M	Doucare Axel	Cadet Kumite Male -57 kg	
		M	ETTORI Thomas	Cadet Kata Male	
		M	EYQUEM Zadig	Cadet Kata Male	
	FRA02767	M	FALCO Enzo	U21 Kumite Male -60 kg	
	SD79167	M	FLEITH Léo	Junior Kata Male	
	SD65553	M	Fournivale Jawel	Junior Kumite Male -61 kg	
	SD67357	M	FRANCES Adrien	Cadet Kata Male	
		M	Garcia Lamas Natan	U14 Kata Male	
	FRA03460	M	GREGOIRE Liam	U21 Kata Male	
		M	HART Enoha	U14 Kata Male	
		M	HASSAINE Salah	Junior Kumite Male -61 kg	
	FRA02784	M	HIERSO Hairiss	U21 Kumite Male -67 kg	
	FRA02808	M	HOFFMANN LUCAS	U21 Kata Male	
		M	HUYET-DUMONG Thomas	Cadet Kata Male	
		M	Jambart Maxence	Cadet Kumite Male -63 kg	
		M	Kandoussi Malek	Cadet Kumite Male -57 kg	
		M	Kanga Kertiss	U21 Kumite Male 84+ kg	
	FRA02973	M	KE GRIFFIN	U21 Kumite Male -67 kg	
	FRA04085	M	KLEMZ Thomas	Junior Kata Male	
		M	LE CHEVILLER Gaspard	U14 Kumite Male -45 kg	
		M	le clech malagrada owen	U14 Kumite Male -55 kg	
		M	Le Guillou Benjamin	Cadet Kumite Male -57 kg	
	FRA004246	M	MALCOIFFE KENZO	U21 Kumite Male -75 kg	
	SD77484	M	MANFREDINI Hugo	Junior Kata Male	
		M	MECHAI Haceyne	Cadet Kumite Male -70 kg	
		M	METENIER ROMAIN	U14 Kumite Male -40 kg	
	FRA03464	M	NDAO Kemi	U21 Kumite Male -75 kg	
	FRA02859	M	NDAO Sassy	U21 Kumite Male -75 kg	
		M	Nguyen Théodore	U14 Kata Male	
		M	Nguyen Théodore	U14 Kumite Male -55 kg	



Karate1 Youth League - Venice 2024



ENTRIES BY NATIONAL FEDERATION

As of 8 DEC 2024

Country Code	ID	Gender	Name	Event	Seed
FRA		M	NGUYEN Toan	Junior Kata Male	
		M	Nock Hugo	Cadet Kata Male	
		M	Nock Mathis	Cadet Kata Male	
	FRA03452	M	NOUI Zakariya	Junior Kumite Male -55 kg	
	FRA02789	M	NOUR MAURIS Lorick	U21 Kata Male	
		M	Parameswaran Anishtan	U21 Kumite Male -67 kg	
	FRA03296	M	PELTIER Tom	U21 Kata Male	
		M	Perini Camil	Junior Kata Male	
		M	PHOMMAVONG Gabriel	Cadet Kata Male	
		M	PICARDAT Sylvain	Cadet Kumite Male -57 kg	
	FRA03434	M	PIERROT GASPARD	U21 Kumite Male -60 kg	
		M	PILLANT Métis	Cadet Kata Male	
		M	PILLANT Métis	Cadet Kumite Male 70+ kg	
		M	RAMDANI MOHAMMED HAROUN	Junior Kata Male	
	SD66035	M	Ribes Bastien	Junior Kumite Male 76+ kg	
		M	ROCHER Erwan	Junior Kumite Male -61 kg	
		M	Sabri Medjid Davin	Junior Kumite Male -61 kg	
		M	SCARFONE Hugo	Cadet Kumite Male -52 kg	
	SD041989	M	SEBBAG Hugo	Junior Kumite Male -68 kg	
		M	SECACHE Timeo	Cadet Kata Male	
	FRA03458	M	Titouah Massinissa	U21 Kumite Male -67 kg	
		M	TRANCARD Lenny	Cadet Kata Male	
	FRA03633	F	ABDESSELEM Silya	U21 Kumite Female -55 kg	
		F	ABID LINA	Junior Kumite Female 66+ kg	
		F	ALLOUCH Youssra	Cadet Kumite Female -47 kg	
		F	ARNE Nawel	U14 Kumite Female -47 kg	
	FRA03459	F	Arzumian Monica	Junior Kumite Female -59 kg	
		F	Barbarin Johanne	U21 Kumite Female -68 kg	
		F	Barbieux Tess	Cadet Kumite Female -61 kg	
		F	BAUDARD LAURE	Junior Kata Female	
		F	BOUDEUF HANNA	Cadet Kata Female	
		F	BOUKERCHE Kenza	Junior Kumite Female -66 kg	
		F	bourouba maissa	Junior Kumite Female -48 kg	
		F	Bouschbacher Lilou	U14 Kumite Female -47 kg	
		F	BOUTELIOUA Mélissa	Junior Kata Female	
	FRA02791	F	BUI Mai-Linh	U21 Kata Female	
		F	CAPET LOUISE	Junior Kata Female	
	FRA03436	F	Cochard Lola	Junior Kumite Female -48 kg	
	FRA03276	F	COCHARD Marylou	U21 Kumite Female -50 kg	
		F	Colin-Rose Jade	Cadet Kumite Female -54 kg	
		F	DEFRANCE Inès	U14 Kata Female	
		F	Doucare Célia	Cadet Kumite Female 61+ kg	
	SD72463	F	DRUJON Maelle	Junior Kata Female	
		F	DUPUIS PARSY Ines	U14 Kumite Female -42 kg	
		F	ECHAMAA Maryam	Cadet Kumite Female -54 kg	
		F	Entem Maëlla	Junior Kata Female	
		F	EVESQUE LORIANE	Cadet Kata Female	
		F	FATMI INES	U14 Kumite Female -47 kg	



Karate1 Youth League - Venice 2024



ENTRIES BY NATIONAL FEDERATION

As of 8 DEC 2024

Country Code	ID	Gender	Name	Event	Seed
FRA		F	Frances Manon	Cadet Kumite Female -54 kg	
		F	Gervasi Cyann	Junior Kumite Female -59 kg	
		F	Gouy Louison	U14 Kumite Female -42 kg	
		F	Grenon Alyssa	U14 Kata Female	
		F	Grenon Jade	Junior Kumite Female -53 kg	
		F	Grisard Maélyne	Cadet Kumite Female 61+ kg	
		F	Gutschmidt Zoe	U14 Kumite Female -47 kg	
		F	Hasbrouck Eva	Junior Kumite Female -53 kg	
	SD59651	F	HERRMANN ADELIA	Junior Kata Female	
		F	KEDADRA Nesrine	Cadet Kumite Female -47 kg	
		F	Kerneur Hermione	Junior Kumite Female -48 kg	
		F	KOUME Lee-Lou	Cadet Kumite Female -47 kg	
		F	Labas Asya	Junior Kumite Female 66+ kg	
		F	Lacourt Emie	U14 Kumite Female -52 kg	
		F	LEFEBVRE VELLA MELODIE	Cadet Kata Female	
		F	LEFAKIRI IKRAM	U14 Kumite Female 52+ kg	
		F	Locoge Maelle	U21 Kata Female	
		F	Marmotte Clara	Junior Kata Female	
		F	Martinez Lola	U14 Kumite Female -52 kg	
		F	mous Sajja	U21 Kata Female	
		F	mous Sajja	U21 Kumite Female -68 kg	
		F	Nakano Lea	Cadet Kata Female	
		F	Niang Maimouna	U21 Kumite Female -55 kg	
		F	ONANA Charlene	Junior Kumite Female -66 kg	
	FRA03516	F	Ordonez Ines	Junior Kata Female	
		F	Ozgun Pelin	U21 Kumite Female -68 kg	
	SD73446	F	Payrot Chloe	Junior Kumite Female -66 kg	
		F	PIAZZA D OLMO Maryon	Cadet Kata Female	
	FRA04089	F	PICAZO LUQUE ELEONOR	Junior Kumite Female -66 kg	
		F	PLANCHENOT Maelys	Cadet Kumite Female -54 kg	
		F	PODINA DANIELA	U14 Kumite Female -47 kg	
	FRA03306	F	Porquet Faith	U21 Kumite Female -68 kg	
		F	Prabel-Cecchini Justine	U14 Kumite Female -52 kg	
		F	Queste Rosie	U14 Kumite Female -52 kg	
		F	RIGEADE Laura Moon	Junior Kumite Female 66+ kg	
		F	ROUSSEAU Ysée	U14 Kumite Female -47 kg	
		F	ROUSSELOT Elais	Junior Kumite Female -59 kg	
		F	Ruiz Oriane	Junior Kumite Female -53 kg	
		F	SAIDANE SARA	Junior Kumite Female -66 kg	
		F	SAIDI Jasmine	U14 Kumite Female -42 kg	
	SD56205	F	Scarfone Morgane	Cadet Kumite Female -54 kg	
	FRA03631	F	SCHMITT ELSA	Junior Kumite Female -53 kg	
	FRA2644	F	TOUVREY JENNA	U21 Kumite Female -55 kg	
		F	Turpin Eloane	Junior Kumite Female -66 kg	
	FRA03840	F	VAUCELLE-SPELLE Ninon	Junior Kata Female	
		F	viana margaux	Junior Kumite Female 66+ kg	
	SD63771	F	Vilanova Julia	Cadet Kata Female	
	FRA02793	F	VINCENT KETHLEEN	U21 Kata Female	



Karate1 Youth League - Venice 2024



ENTRIES BY NATIONAL FEDERATION

As of 8 DEC 2024

Country Code	ID	Gender	Name	Event	Seed	
FRA	SD67353	F	VORATOVIC Iliana	Cadet Kata Female		
		F	VUILLEMIN Mailyynn	Junior Kata Female		
		F	Weiss Lisa	U21 Kumite Female -55 kg		
		F	Yapoby Camerone	Cadet Kata Female		
	SD71749	F	YORO Eden	Cadet Kumite Female -61 kg		
	FRA02778	F	YVON Sydney	U21 Kumite Female -61 kg		
PYF		F	CAVANIE KENLY	U21 Kumite Female -61 kg		
GEO	GEO02813	M	DADESHKELIANI LEVANI	Cadet Kumite Male -52 kg		
	GEO02812	M	GABRAVA ILIA	U14 Kumite Male -40 kg		
	GEO02556	M	GIGAURI NIKOLOZ	Junior Kumite Male 76+ kg		
	GEO002911	M	KHATISASHVILI DAVIT	Cadet Kumite Male -52 kg		
	GEO002912	M	KOZIREVI TEVDORE	Cadet Kumite Male -57 kg		
	GEO002910	M	ZAKARAIA GIORGI	U14 Kumite Male -50 kg		
GER	GER03127	M	ABU WAHIB JONAS	Junior Kata Male		
	GER03288	M	Aktas Fatih	U21 Kumite Male -67 kg		
	GER03866	M	ALBIEN ALEXANDER	Cadet Kata Male		
		M	Aleksiev Antonov Aleks	U21 Kata Male		
		M	Athanasias Apostolos-Christos	U14 Kata Male		
	GER03862	M	ALTKEMPER SAM	Junior Kumite Male -55 kg		
		M	Al Hamad Mehvan	Cadet Kata Male		
		M	Azadi Bijan	U14 Kumite Male +55 kg		
	GER03356	M	Becker Finley	Cadet Kumite Male -57 kg		
	GER03274	M	BECKER SEBASTIAN	Junior Kata Male		
	GER03355	M	Becker Yannik	Cadet Kumite Male -52 kg		
		M	Beckmann Max	U14 Kumite Male -55 kg		
		M	Blumenauer Alec	U21 Kumite Male -60 kg		
		M	Braun Daniel	Cadet Kata Male		
		M	Braunroth Florian	U14 Kumite Male -50 kg		
		M	Bruno Gabriel	Junior Kumite Male -61 kg		
		GER004014	M	BUECKERT JONAS	Cadet Kata Male	
			M	Dahm Aurelius	U14 Kumite Male -45 kg	
		GER02762	M	Dahm William Miyamoto	Junior Kumite Male -61 kg	
			M	Damiani Danilo	U14 Kumite Male -40 kg	
	GER02806	M	Deutsch Pascal	U21 Kumite Male -84 kg		
		M	Dommsch Louis	U21 Kumite Male -84 kg		
		M	Drehmann Till	Cadet Kumite Male -63 kg		
		M	Eckerdt Daniel	U14 Kumite Male -40 kg		
		M	Ehmke Jeremias	Junior Kumite Male -61 kg		
		M	Elenberger Alexander	Junior Kumite Male -76 kg		
		GER03809	M	FRENSEL PAUL	Junior Kumite Male 76+ kg	
			M	Ganjzadeh Mohammad-Reza	U21 Kumite Male -67 kg	
	M		Glaevecke Damien	Junior Kata Male		
	M		Gräfe Lukas	U14 Kumite Male +55 kg		
M	Grasmeier Eric		U14 Kata Male			
M	Grillinger Jonah		U14 Kumite Male -45 kg			
M	Grünelt Oliver		Cadet Kumite Male -52 kg			



Karate1 Youth League - Venice 2024



ENTRIES BY NATIONAL FEDERATION

As of 8 DEC 2024

Country Code	ID	Gender	Name	Event	Seed
GER		M	Gschwind Viktor	Junior Kata Male	
		M	Haueisen Anton	Cadet Kata Male	
	GER03144	M	Heinrich Adrian	U21 Kumite Male -84 kg	
	GER03280	M	Heller Ben	Junior Kumite Male -76 kg	
	GER003977	M	HOERNER PAUL	Cadet Kumite Male -57 kg	
		M	Jahns Müller Adrian	Cadet Kata Male	
		M	Jendreizik Ole	U21 Kumite Male -84 kg	
		M	Jorde-Nakamatsu Lio	Cadet Kata Male	
		M	Kalies Tom	Cadet Kumite Male -52 kg	
		M	Karaca Ilyas	U14 Kumite Male -40 kg	
		M	Kistner Andrej	Cadet Kata Male	
		M	Knauer Benedikt Franz Xaver	Junior Kumite Male 76+ kg	
	GER03358	M	Knopp Phil	Junior Kumite Male -76 kg	
	GER03262	M	Koch Adrian	Junior Kumite Male -76 kg	
		M	Koch Alexander	Junior Kata Male	
		M	Korhan Yasin	Junior Kumite Male -76 kg	
		M	Krause Johannes	U14 Kumite Male -45 kg	
		M	Kuchel Lennox	Cadet Kumite Male -63 kg	
	GER03797	M	KUNIYASU HARUAKI	Cadet Kata Male	
		M	Kuniyasu Shouta	U14 Kata Male	
		M	Kurz Phil	Cadet Kumite Male -70 kg	
		M	Libik Daniel	Cadet Kata Male	
		M	Linke Florian	U14 Kumite Male -50 kg	
		M	Liubimov Dmytro	Cadet Kumite Male -70 kg	
	GER02852	M	LUECK AARIC LAM	U21 Kata Male	
	GER03128	M	LUECK ANDREW LYLE	Junior Kata Male	
	GER003924	M	MUELLER MARIUS	Cadet Kumite Male -70 kg	
		M	Müller Jonas	Junior Kumite Male -68 kg	
		M	Münch Fabio	Cadet Kata Male	
		M	Nahrman Mattis	Cadet Kumite Male -57 kg	
	GER003980	M	NAMYSLIK FELIX	Cadet Kumite Male -52 kg	
	GER03306	M	Niederelz Tim	Cadet Kumite Male -63 kg	
		M	Nikolaidis Ioannis	U14 Kata Male	
	GER03148	M	Nowizki Michael	U21 Kumite Male -60 kg	
	GER03121	M	Obitz Florian	U21 Kumite Male -60 kg	
	GER2584	M	Özdemir Muhammed	U21 Kumite Male -60 kg	
		M	Pagin Lukasz	Cadet Kumite Male -63 kg	
		M	PARKHOMENKO ARTEM	Cadet Kumite Male 70+ kg	
	GER03147	M	Pfennig Maximilian	U21 Kumite Male -75 kg	
		M	Piechot Thomas	Junior Kata Male	
		M	Pieper Maximilian	U14 Kumite Male -45 kg	
	GER004013	M	RAAZ JULIAN	Cadet Kumite Male -70 kg	
	GER003925	M	RAISWICH ROMAN	Junior Kumite Male -68 kg	
		M	Rath Konstantin	Junior Kumite Male -76 kg	
		M	Reiter Patrick	U21 Kata Male	
		M	Ridiger Eric	Junior Kumite Male 76+ kg	
		M	Ruhmann Benjamin	U14 Kumite Male -50 kg	
		M	Ruhmann Max	Cadet Kumite Male -57 kg	



Karate1 Youth League - Venice 2024



ENTRIES BY NATIONAL FEDERATION

As of 8 DEC 2024

Country Code	ID	Gender	Name	Event	Seed
GER		M	Ruris Adrian	Junior Kumite Male -68 kg	
	GER03357	M	SAFI HEIDAR	Junior Kumite Male -61 kg	
		M	Schiefelbein Jonas	U14 Kata Male	
		M	Schmidtgen Aurel	Cadet Kumite Male 70+ kg	
		M	Sejfic Sefo	U21 Kumite Male 84+ kg	
	GER03153	M	Sekot Nikolai	U21 Kumite Male 84+ kg	
	GER02815	M	Stamer Narvik	U21 Kumite Male -67 kg	
		M	Stauffenberg Friedolin	Cadet Kumite Male -52 kg	
		M	Swidersky Ben	Cadet Kumite Male -57 kg	
		M	Theobald Phil	U14 Kata Male	
		M	Tlili Ahmed Rayane	U21 Kumite Male -75 kg	
	GER02761	M	Tschenisch Thore	Junior Kumite Male 76+ kg	
		M	Tschumarow André	Cadet Kumite Male -57 kg	
	SD60980	M	Voigt Tilmann	Junior Kumite Male -76 kg	
	SD49448	M	Volpe Renzo	U21 Kumite Male -75 kg	
		M	von Treschkow Nepomuk	U14 Kumite Male -50 kg	
		M	Wabingga Djego Lee	Cadet Kata Male	
	GER02742	M	Walger Philipp	U21 Kumite Male -75 kg	
		M	Yildirim Senol	Junior Kumite Male -76 kg	
		M	Zeitler Fabian	Junior Kumite Male -68 kg	
		M	Ziza Rayan	U21 Kata Male	
	GER03123	M	ZUNIGA SPAETHE ROBIN MATEO	Junior Kumite Male -76 kg	
		F	Aßmann Linnea	Cadet Kata Female	
	GER003877	F	BAGHDJIAN DANA	Cadet Kata Female	
		F	Baumgärtner Lara	U14 Kumite Female -47 kg	
		F	Baumgärtner Lena	U14 Kumite Female -42 kg	
		F	Becker Céline	U14 Kumite Female 52+ kg	
		F	Bergmann Liya	Cadet Kumite Female 61+ kg	
		F	Biedemann Greta	Cadet Kata Female	
		F	Biedemann Hannah	Cadet Kata Female	
		F	Bobbert Aitana	Junior Kata Female	
	GER03296	F	Bobbert Isabella	U21 Kata Female	
		F	Bradel Stella	Junior Kumite Female -48 kg	
	GER02952	F	Braun Anna	U21 Kata Female	
		F	Brettnacher Mia	Junior Kumite Female -48 kg	
		F	Bruns Laura	Cadet Kumite Female -47 kg	
		F	Corbo Josefine	U14 Kata Female	
		F	Damm Lisa	Cadet Kumite Female -54 kg	
	GER03808	F	DAWOUD DALIA	Junior Kumite Female 66+ kg	
		F	Dietrich Enie	U14 Kumite Female -47 kg	
	GER03301	F	Drehmann Emily-Chiara	Junior Kumite Female -48 kg	
	GER03796	F	DREWES LEYLA	Cadet Kata Female	
		F	Ehling Magdalena	Cadet Kata Female	
	GER03868	F	EWALD CLARA	Junior Kata Female	
		F	Filina Amina	Junior Kumite Female -66 kg	
		F	Flemming Johanna-Helene	Cadet Kumite Female -61 kg	
		F	Födisch Jessica	Junior Kata Female	
		F	Förster Alexia	U14 Kumite Female -52 kg	



Karate1 Youth League - Venice 2024



ENTRIES BY NATIONAL FEDERATION

As of 8 DEC 2024

Country Code	ID	Gender	Name	Event	Seed
GER	GER03137	F	FRATILA CRISTINA-MARIA	Junior Kumite Female -66 kg	
	SD75531	F	Gallert Lilli	Cadet Kumite Female 61+ kg	
		F	Giegling Milena	Cadet Kumite Female 61+ kg	
	GER004012	F	GOETHE MARIEL	Cadet Kata Female	
		F	Gottschalk Emma	Cadet Kumite Female -54 kg	
GER03302		F	Gräfe Lotte	Cadet Kumite Female 61+ kg	
GER03273		F	Griessel Carolina	U21 Kata Female	
		F	Gruber Daria	Cadet Kata Female	
		F	Grüner Valentina	U14 Kumite Female -47 kg	
		F	Gündüz Ceylin-Nida	Cadet Kumite Female -61 kg	
SD48893		F	Hamzah Amira	Junior Kumite Female -59 kg	
		F	Hapfelmeier Louisa	U14 Kata Female	
		F	Hebbel Patricia	U21 Kata Female	
		F	Heinrich Alina	Cadet Kumite Female 61+ kg	
GER03304		F	HELLEN ILI	Junior Kumite Female -59 kg	
		F	Henze Hannah	Junior Kumite Female -53 kg	
		F	Hering Alia	Junior Kumite Female -66 kg	
		F	Hübinger Melina	U14 Kumite Female -52 kg	
		F	Isejnoska Advija	U14 Kata Female	
		F	Iskandaryan Anne-Marie	Cadet Kata Female	
GER03126		F	JAY SHIRLEY	Junior Kata Female	
		F	Karadal Eda	U14 Kata Female	
		F	Karadal Ela	U14 Kata Female	
		F	Keller Kristina	U21 Kumite Female -61 kg	
		F	Khalil Lana	U14 Kumite Female -52 kg	
GER03639		F	KOENIG LIV SVENDE	Cadet Kumite Female -61 kg	
		F	Kollmann Mara Luise	Cadet Kata Female	
		F	Konradi Arwen	Cadet Kumite Female 61+ kg	
SD61923		F	Kostbar Evelyn	Junior Kumite Female -66 kg	
		F	Lampersberger Emilia	U14 Kata Female	
		F	Lange Josephine	Cadet Kumite Female 61+ kg	
		F	Längerer Laetizia	Cadet Kata Female	
		F	Längerer Stella	Cadet Kata Female	
		F	Libik Tamara	Cadet Kata Female	
		F	Liedke Loreen	U14 Kumite Female -52 kg	
GER03284		F	Lindstädt Marlene	U21 Kumite Female -68 kg	
		F	Lippert Helena	U14 Kata Female	
		F	Lowry Livia	Cadet Kumite Female -54 kg	
		F	Mattys Melina	Cadet Kumite Female -61 kg	
GER03220		F	Meinert Jacqueline	Junior Kumite Female -59 kg	
		F	Meißner Elisabeth	Cadet Kumite Female -61 kg	
		F	Meyen Selda	U14 Kumite Female -52 kg	
GER03285		F	MUSSWEILER MIA	Junior Kumite Female -59 kg	
		F	Nikolic Masa	Cadet Kumite Female 61+ kg	
		F	Olschewski Hanna	U14 Kumite Female -47 kg	
GER02725		F	Ott Sidney-Michelle	U21 Kumite Female -50 kg	
		F	Paulus Chayenne	U14 Kumite Female 52+ kg	
		F	Podlaszewska Kirana	U14 Kumite Female -52 kg	



Karate1 Youth League - Venice 2024



ENTRIES BY NATIONAL FEDERATION

As of 8 DEC 2024

Country Code	ID	Gender	Name	Event	Seed	
GER	GER003879	F	PODVOREC NIVES	Cadet Kumite Female -47 kg		
		F	Poh Nadine	Junior Kata Female		
		F	Pönitz Hayley	U14 Kumite Female -52 kg		
		F	Pyvovarova Kateryna	Cadet Kumite Female -61 kg		
	GER03292	F	Rabhi Douaa	U21 Kumite Female -61 kg		
		F	Rausch Lisa	Cadet Kumite Female 61+ kg		
	GER02746	F	Riedel Hannah	U21 Kumite Female -68 kg		
		F	Röder Luise	U14 Kumite Female -47 kg		
	GER03138	F	Rühlmann Charlotte	U21 Kumite Female 68+ kg		
		F	Rumpf Cilia	U14 Kumite Female -52 kg		
		F	Ruppel Maria	Cadet Kumite Female -54 kg		
		F	Safi Dania	U14 Kumite Female -42 kg		
	GER03806	F	SAFI MALLAK	Cadet Kumite Female -54 kg		
	GER03117	F	Sassenberg Johanna	Junior Kumite Female -66 kg		
	SD807896	F	Schaudig Luisa	U14 Kata Female		
	GER03305	F	SCHINDLER MILEY	Cadet Kumite Female 61+ kg		
		F	Schlegel Ronja	U14 Kumite Female -47 kg		
		F	Schmitz Celine	Junior Kumite Female -53 kg		
		F	Schmitz Josie	Junior Kumite Female -66 kg		
		F	Schneider Anna-Marie	Cadet Kumite Female -61 kg		
		F	Schopp Maksima	Cadet Kumite Female 61+ kg		
		F	Schulz Zoe	U14 Kata Female		
		SD60877	F	Schwab Laura	Junior Kumite Female -66 kg	
			F	Seiler Laura Sophie	Cadet Kata Female	
		GER03258	F	Semenenko Anastasiia	U21 Kumite Female -61 kg	
		GER02850	F	Siebert Rita	U21 Kata Female	
		GER03116	F	Siemon Nora	Junior Kumite Female -53 kg	
			F	Sirichenko Anfissa	U14 Kumite Female -47 kg	
	F		Stevens Julie	U21 Kata Female		
	F		Strzemedłowska Martyna	Cadet Kumite Female 61+ kg		
	F		Susnica Mila Marija	Cadet Kumite Female -61 kg		
	F		Tahiri Nada	Cadet Kumite Female -47 kg		
	F		Telli Aylin	U21 Kumite Female -55 kg		
F	Theobald Mia		Cadet Kumite Female 61+ kg			
GER2585	F		Tsoucalas Charleene	U21 Kumite Female -61 kg		
	F		Tsvilii Zlata	U14 Kumite Female -47 kg		
GER02745	F		VLAJ JESSICA	U21 Kata Female		
	F	Voigt Johanna	U14 Kumite Female -52 kg			
	F	Wienbeck Rani	Cadet Kata Female			
	F	Wierzbicki Evelyn	U14 Kumite Female -42 kg			
	F	Witte Franziska	Junior Kata Female			
	F	WOLF ALEXANDRA	Junior Kumite Female -53 kg			
GER03135	F	Wybraniec Dana Ellen	U14 Kumite Female 52+ kg			
GRE	GRE02961	M	ANGELIS GEORGIOS	U14 Kumite Male -50 kg		
	GRE03454	M	ANTONIOU VASILEIOS	U14 Kumite Male -55 kg		
	GRE02321	M	BALLOTIS GEORGIOS	U21 Kumite Male -67 kg		
	GRE2156	M	BITSORIS ANDREAS	U21 Kumite Male -67 kg		



Karate1 Youth League - Venice 2024



ENTRIES BY NATIONAL FEDERATION

As of 8 DEC 2024

Country Code	ID	Gender	Name	Event	Seed
GRE	GRE02894	M	BITSORIS ANGELOS	Cadet Kumite Male -57 kg	
		M	BOUTSIKAS KYRIAKAKIS ELEFThERIOS	U14 Kumite Male -40 kg	
	GRE003946	M	CHARALAMPIDIS NIKOLAOS TAXIARCHIS	U14 Kumite Male -50 kg	
	GRE02635	M	FILIAGKOS ATHANASIOS	Cadet Kumite Male -52 kg	
	GRE003935	M	GEORGILAS ZACHARIAS	U14 Kumite Male +55 kg	
	GRE02456	M	KARRAS PETROS	Junior Kumite Male -68 kg	
	GRE03030	M	KATECHIS ANGELOS LOUKAS	U14 Kata Male	
	GRE02497	M	MATSOTAS ATHANASIOS	U21 Kumite Male -84 kg	
		M	MERKOURIS THEODOROS	U21 Kumite Male -60 kg	
	GRE02448	M	MOKAS MICHAIL	Junior Kumite Male 76+ kg	
	GRE2183	M	Moraitis Nikolaos	U21 Kumite Male -84 kg	
	GRE003927	M	NTINTEMPASVILI DAVID	U14 Kumite Male -45 kg	
	GRE003926	M	NTINTEMPASVILI LEONIDAS	Junior Kumite Male -61 kg	
		M	PANTAZIS ATHANASIOS	Cadet Kumite Male -52 kg	
	GRE02758	M	PAPADOPOULOS DIMOSTHENIS	Junior Kumite Male -55 kg	
	GRE02629	M	PAPADOPOULOS GEORGIOS	U21 Kumite Male -75 kg	
		M	PAPAGRIGORIOU KOSMAS	Cadet Kumite Male -70 kg	
	GRE02900	M	PSOMAS ILIAS	Junior Kumite Male 76+ kg	
	GRE03073	M	STAVROULAKIS ILIAS	U14 Kumite Male -40 kg	
		M	TSAGARAKIS MILTIADIS	U14 Kumite Male -50 kg	
		M	VYTHOULKAS GEORGIOS	U14 Kata Male	
	GRE03883	M	ZORPIDIS ANGELOS	Cadet Kumite Male 70+ kg	
	GRE02831	F	ANASTASIOU MARIA-GEORGIA	U21 Kumite Female 68+ kg	
	GRE03611	F	ANDREOU ANDRIANI	Junior Kumite Female 66+ kg	
		F	ANDREOU MARIA	U14 Kumite Female -47 kg	
	GRE03008	F	CHYTI VALERIANI	U14 Kumite Female -47 kg	
		F	DOUKA EFFROSYNI - DAVIDOULA	Cadet Kumite Female 61+ kg	
		F	DOUKA VIOLETTA-FANOURIA	Cadet Kumite Female 61+ kg	
	GRE003748	F	EVGENIADOU APOSTOLIA	U14 Kumite Female -47 kg	
	GRE030037 47	F	EVGENIADOU MELINA MARIA	Cadet Kumite Female -61 kg	
	GRE03516	F	FAGOGENI VASILIKI	Cadet Kumite Female 61+ kg	
	GRE003489	F	GEORGILA STYLIANI	U14 Kumite Female 52+ kg	
	GRE003947	F	INGLESI ELEFThERIA THEODOSIA	Cadet Kumite Female -61 kg	
		F	KOCHYLA DIMITRA VARVARA	U14 Kumite Female 52+ kg	
		F	KOMINI ILIANA	Cadet Kumite Female -47 kg	
		F	KONSTA EVANTHIA EVANGELIA	U14 Kumite Female -47 kg	
	GRE003929	F	KOUROUVAKALI STYLIANI	U14 Kumite Female 52+ kg	
	GRE03453	F	MOUSOULI ANNA	U14 Kumite Female -52 kg	
	GRE03520	F	NANNOU AIKATERINI	U14 Kumite Female -42 kg	
	GRE03091	F	NIKOLOPOULOU STYLIANI-GEORGIA	Cadet Kumite Female -47 kg	
	GRE02920	F	PAGONIDOU ATHANASIA	Cadet Kumite Female -61 kg	
	GRE003928	F	PAPADAKI MELINA	U14 Kumite Female 52+ kg	
	GRE02642	F	Pappa Christina Triada	Junior Kumite Female -48 kg	
	GRE03623	F	PARASKEVOPOULOU MARINA	Junior Kumite Female -53 kg	
		F	Pergalia Agathi Agapi	U14 Kumite Female 52+ kg	



Karate1 Youth League - Venice 2024



ENTRIES BY NATIONAL FEDERATION

As of 8 DEC 2024

Country Code	ID	Gender	Name	Event	Seed
GRE		F	Pergalia Anastasia Eirini	U14 Kumite Female 52+ kg	
	GRE003812	F	POLYKANDRIOTI ERIFYLI NIKOLETTA	U14 Kumite Female 52+ kg	
	GRE03474	F	POLYKRETI ANASTASIA	U14 Kumite Female 52+ kg	
	GRE03745	F	RESVANI VASILIKI	Cadet Kumite Female -54 kg	
	GRE003889	F	ROUVINETI ELENI	U21 Kumite Female -61 kg	
	GRE02897	F	SYKA AGNI	Junior Kumite Female -48 kg	
	GRE03079	F	TRIAANTAFYLLI FAIDRA	U14 Kumite Female -42 kg	
	GRE03081	F	TSALAVOU ELENI MYRTO	Cadet Kumite Female -54 kg	
	GRE02495	F	TSIAKMAKI ATHINA	Junior Kata Female	
		F	TZANI ZOI	Junior Kumite Female -53 kg	
		F	VASILOPOULOU EMMANOUELA FOTEINI	U14 Kata Female	
		F	VASILOPOULOU EMMANOUELA FOTEINI	U14 Kumite Female -42 kg	
	GRE02320	F	XENOU LYDIA LAMPRINI	U21 Kumite Female -55 kg	
HKG	HKG02474	M	CHIU CHUN YIN	U21 Kata Male	
	HKG02513	M	CHIU WING HEI	Junior Kata Male	
	HKG02383	M	KWOK HO HIM	U21 Kata Male	
	HKG02713	M	LAM TSZ PUI	Cadet Kumite Male -57 kg	
	HKG02470	M	LI MAN HEI	U21 Kumite Male -67 kg	
	HKG02712	M	LUI TO MING	Cadet Kumite Male 70+ kg	
	HKG02475	M	TSANG PAK YIN	Junior Kata Male	
	HKG02669	M	WONG NURI	Cadet Kata Male	
	HKG002856	F	CHEUNG WING YI	U21 Kata Female	
	HKG02676	F	TAM CHEUK YI	U21 Kata Female	
	HKG02511	F	WONG HAN YI HIDY	Junior Kumite Female -53 kg	
HUN		M	Albert Noé	Cadet Kumite Male -52 kg	
		M	András István Tamási	Cadet Kumite Male -52 kg	
		M	Árkos Olivér	Junior Kumite Male 76+ kg	
		M	Bagi Ádám	U14 Kumite Male -50 kg	
		M	Bali Tibor	U14 Kumite Male +55 kg	
		M	Bálint Gombkötő	Cadet Kumite Male 70+ kg	
		M	Bárdos Ádám	U21 Kata Male	
		M	Bartalis Ádám	Cadet Kumite Male 70+ kg	
		M	Bene Csaba	Cadet Kumite Male -57 kg	
	HUN02535	M	Berczes Botond	U21 Kata Male	
		M	Bilal David Musah	Cadet Kumite Male -57 kg	
		M	Czudor Olivér	Junior Kumite Male -76 kg	
		M	David Lisal	Junior Kumite Male 76+ kg	
		M	Dávid Ákos Csiki	Cadet Kumite Male -57 kg	
	HUN02536	M	Elekes Máté	U21 Kata Male	
		M	Fejér Milán	Cadet Kumite Male -57 kg	
		M	Fekete Márton Rudolf	Cadet Kumite Male -63 kg	
		M	Felszner Erik	Junior Kumite Male -68 kg	
		M	Freund Péter	U21 Kumite Male 84+ kg	
		M	Gereben Ábel	Cadet Kumite Male -52 kg	
	HUN02868	M	Gulyás Gergely	Junior Kata Male	



Karate1 Youth League - Venice 2024



ENTRIES BY NATIONAL FEDERATION

As of 8 DEC 2024

Country Code	ID	Gender	Name	Event	Seed
HUN		M	Gyurcsek Vince	Cadet Kumite Male -57 kg	
		M	Hecker Armin	Junior Kumite Male -55 kg	
		M	Hegedus Robert	U21 Kumite Male -75 kg	
		M	Hercz Bence	U14 Kumite Male -50 kg	
		M	Horváth-Matheidesz Vilmos	Cadet Kumite Male -57 kg	
		M	Huszár Márk	Junior Kumite Male 76+ kg	
		M	Kis Mátyás	U14 Kumite Male +55 kg	
		M	Knirsch Patrik	U21 Kumite Male -75 kg	
		M	Kökény Kiss Péter	Cadet Kumite Male 70+ kg	
		M	Kovács Gergely Kristóf	Junior Kumite Male -61 kg	
		M	Kovács Konrád	Cadet Kumite Male -70 kg	
		M	Kürk Zétény	U14 Kumite Male -50 kg	
		M	László Samu	Junior Kata Male	
		M	Losonci Lóránt Marcell	Cadet Kumite Male -57 kg	
		M	Miklós-Kokor Alex Balázs	Cadet Kata Male	
		M	Nagy Ákos Botond	Cadet Kumite Male -63 kg	
		M	Osváth Ákos Ferenc	Junior Kumite Male -55 kg	
		M	Pap Dominik	U14 Kumite Male -40 kg	
		M	Peres Makszim	U14 Kumite Male -45 kg	
		M	Péter Márton	Cadet Kumite Male -63 kg	
		M	Peter Balint Illes	Cadet Kumite Male -63 kg	
		M	Péter Csiki Csanád	Cadet Kumite Male -57 kg	
		M	Piry Péter	Cadet Kumite Male 70+ kg	
		M	Ruzsinszki Balázs	Cadet Kumite Male -70 kg	
		M	Szabolcs Pásztor	Cadet Kumite Male -52 kg	
		M	Szőcs Ambrus	U21 Kumite Male -67 kg	
		M	Szőcs Miksa	Cadet Kumite Male -52 kg	
	HUN02531	M	Tóth Máté Roland	Junior Kumite Male -61 kg	
	HUN02532	M	Tóth Zsombor Zoltán	Junior Kumite Male -68 kg	
		M	Tülkös Roland Nándor	Junior Kumite Male -76 kg	
		M	Turányi Márton	Cadet Kumite Male -52 kg	
		M	Turányi Mátyás	Junior Kumite Male -61 kg	
		M	Zsombor Dudás	U21 Kumite Male -67 kg	
		F	Ádám Adrienn	Junior Kumite Female -59 kg	
	HUN02781	F	Ádám Alexandra	U21 Kumite Female -68 kg	
		F	Ádám Vivien	Cadet Kumite Female 61+ kg	
		F	Arnóth Lilla Johanna	U14 Kumite Female -42 kg	
		F	Bacsó Kata	Cadet Kata Female	
		F	Bárdos Anna	Junior Kumite Female -53 kg	
	HUN02666	F	Bene Bianka	U21 Kumite Female -55 kg	
		F	Benkő Nóra	U14 Kata Female	
		F	Benkő Szonja Lola	Cadet Kata Female	
	HUN02618	F	Bogdán Panna	Junior Kumite Female -66 kg	
		F	Dalnoki Szófia	Junior Kumite Female -53 kg	
		F	Deák Sára	Junior Kumite Female -48 kg	
		F	Elgozali Aida	Cadet Kumite Female 61+ kg	
	HUN02677	F	Fleischer Dóra	U21 Kumite Female 68+ kg	
		F	Fodor Amira	Junior Kata Female	



Karate1 Youth League - Venice 2024



ENTRIES BY NATIONAL FEDERATION

As of 8 DEC 2024

Country Code	ID	Gender	Name	Event	Seed
HUN	HUN2389	F	Hecker Bojana	U21 Kumite Female -50 kg	
		F	Hefner Zsófia	Cadet Kumite Female -47 kg	
		F	Hógenburg Luca	U21 Kata Female	
		F	Höning Jelena	Junior Kumite Female -66 kg	
		F	Husztly Zsuzsanna	U14 Kata Female	
		F	Jakab Eszter Abigél	Cadet Kumite Female -61 kg	
		F	Kopfer Anna	Junior Kumite Female 66+ kg	
	HUN02490	F	Loyal Emma Lili	U21 Kumite Female -68 kg	
	HUN2393	F	Molnár Virág	U21 Kumite Female -55 kg	
	HUN02787	F	Nagypál Ibolya	Junior Kumite Female 66+ kg	
		F	Pap Kincső	Cadet Kumite Female -47 kg	
		F	Pénzes Csiszár Fruzsina	Cadet Kumite Female -54 kg	
		F	Perényi Aida	Cadet Kumite Female -61 kg	
		F	Róka Lilla	Cadet Kumite Female -54 kg	
		F	Szatmáry Karolina	Cadet Kata Female	
		F	Szebegyinszki Rita	Cadet Kumite Female 61+ kg	
		F	Török Panka	Junior Kumite Female -59 kg	
HUN02867		F			
ISL		ISL2109	M	Halldórsson Hugi	U21 Kumite Male -84 kg
IND		F	Ramesh Nakshatra Ira	U14 Kumite Female -42 kg	
AIN-1		M	Grishkin Egor	U14 Kumite Male -55 kg	
		F	GASHNIKOVA VERONIKA	Junior Kumite Female -53 kg	
		F	LIASKALO SOFIIA	Junior Kumite Female -59 kg	
		F	TEBRYAEVA YANA	Junior Kumite Female 66+ kg	
AIN-2		F	MARKAVA ULYANA	U21 Kumite Female -50 kg	
IRL	IRL02652	M	HOLOHAN CONOR	U21 Kata Male	
	IRL003055	M	MCGLYNN MICHAEL	U14 Kumite Male +55 kg	
	IRL02946	M	MC CANN CALVIN	Cadet Kata Male	
	IRL02843	M	PHELAN SEAN	Junior Kumite Male -55 kg	
	IRL02797	F	CLARE AVA	U21 Kumite Female 68+ kg	
	IRL003058	F	MCCRACKEN KATELYNN	U21 Kumite Female 68+ kg	
	IRL02329	F	MCDERMOTT ZOE	U21 Kumite Female 68+ kg	
	IRL003051	F	OREILLY REBECCA	U21 Kata Female	
	IRL02801	F	O BRIEN SADHBH	U21 Kumite Female -61 kg	
IRI		M	Ghavam Yazdan	Cadet Kata Male	
		M	Naghdi Mohammad Mahdi	U21 Kata Male	
	IRI03232	M	Torabi Mohammadreza	U21 Kumite Male -75 kg	
		M	Zeinali shalmaei Amir sam	Cadet Kumite Male 70+ kg	
		F	Alizadehchamazketi Paria	U21 Kumite Female -61 kg	
		F	Farzin Mahdis	U14 Kumite Female -42 kg	
		F	Nouri Sarina	Junior Kumite Female -66 kg	
		F	Pourzangeneh Taraneh	Cadet Kumite Female -61 kg	
		F	Soltani Dehnavi Hasti	Cadet Kumite Female -61 kg	
		F	Zeinali Helya	U21 Kata Female	
ITA		M	ADOLINI DIEGO	U14 Kumite Male -55 kg	
		M	AGOSTINELLI ALESSANDRO	U14 Kumite Male -45 kg	



Karate1 Youth League - Venice 2024



ENTRIES BY NATIONAL FEDERATION

As of 8 DEC 2024

Country Code	ID	Gender	Name	Event	Seed	
ITA	ITA03008	M	AGUS MARIO	U21 Kumite Male -60 kg		
	ITA04283	M	alfano nicolò	U21 Kumite Male -60 kg		
		M	ALLEGRETTA SIMONE	Junior Kumite Male -55 kg		
	M	ALLEGRI MATTEO	U14 Kumite Male -45 kg			
	M	aloise leonardo	Junior Kata Male			
	M	Amarante Antonio	Junior Kumite Male -61 kg			
	M	Amarie Alessio Filippo	Junior Kumite Male 76+ kg			
	M	ANGEI FERRARIO LUCA	Cadet Kumite Male 70+ kg			
	M	ANNOVAZZI MATTEO	Junior Kumite Male -68 kg			
	M	ANNUNZIATA DAVIDE	U14 Kumite Male -55 kg			
	M	Apicella Carmine	Cadet Kumite Male -57 kg			
	M	ARECCO MATTEO	Junior Kumite Male -68 kg			
	M	ARMANO GIANFRANCO	Cadet Kumite Male -70 kg			
	M	ARMANO MANUELE	U21 Kumite Male -75 kg			
	M	Artemciuc Denis	Junior Kata Male			
	ITA04245	M	Astarita Raffaele	U21 Kumite Male -67 kg		
		M	aureli leonardo	U21 Kumite Male -60 kg		
		M	BAGAROLO THOMAS	Junior Kata Male		
		M	BALDASSARRE RAFFAELE	Cadet Kumite Male -63 kg		
		M	Baldassarre Samuel Vincenzo	U14 Kumite Male -50 kg		
		M	bamundo domenico	Cadet Kumite Male -57 kg		
		M	Barone Salvatore	Cadet Kumite Male -57 kg		
		M	Baroni Edoardo	Junior Kata Male		
		ITA04509	M	Bartolini Francesco	Junior Kata Male	
			ITA04408	M	BASILE MANUEL	Junior Kumite Male -68 kg
	M	Basoni Francesco Pio		U14 Kumite Male -50 kg		
	M	Basso Marco		Cadet Kumite Male -63 kg		
	M	bellillo Nicolò		Cadet Kumite Male -70 kg		
	M	BELLINZONA ROCCO		Cadet Kumite Male -57 kg		
	M	BENOTTO ALESSIO		Cadet Kumite Male -70 kg		
	M	BERGANTINO DAVIDE		U14 Kumite Male -55 kg		
	M	Bergna Lorenzo		U14 Kumite Male -40 kg		
	M	BERLUSCONI DAVIDE		Cadet Kumite Male 70+ kg		
M	Bersanetti Andrea	Cadet Kumite Male -63 kg				
M	Berton Simone	U14 Kumite Male -40 kg				
M	Besutti Luca	U14 Kumite Male -45 kg				
M	Bianco Alessandro	Cadet Kumite Male -70 kg				
ITA04498	M	Bicos Nikita		Junior Kata Male		
	M	Biggiogero Matteo		U14 Kumite Male -40 kg		
ITA04212	M	BOMBARDI LEONARDO		U21 Kata Male		
	M	Bon Edoardo		U14 Kata Male		
	M	Bon Edoardo	U14 Kumite Male -45 kg			
	M	Boraso Tancredi	Cadet Kumite Male -63 kg			
	M	BOTTINI Francesco	Junior Kata Male			
ITA03618	M	BOZZI ANDREA	U21 Kumite Male -84 kg			
	M	Bozzi EMANUELE	U14 Kumite Male -45 kg			
	M	Brachini Leonardo	Cadet Kata Male			
	M	Braja Gabriele	U21 Kumite Male -67 kg			



Karate1 Youth League - Venice 2024



ENTRIES BY NATIONAL FEDERATION

As of 8 DEC 2024

Country Code	ID	Gender	Name	Event	Seed
ITA		M	Branchi Niccolò	Junior Kumite Male 76+ kg	
		M	BRANDI JACOPO	Junior Kumite Male -61 kg	
		M	BRASILE ANTONIO	Junior Kata Male	
		M	Brogi Tommaso	Junior Kumite Male -68 kg	
		M	Brundu Cristian	Junior Kata Male	
		M	BRUNI DAVIDE	U14 Kata Male	
		M	BUONDONNO MANUEL	U14 Kumite Male +55 kg	
		M	Burali Davide	Junior Kata Male	
	ITA04409	M	BURROSI SAMUELE	Junior Kumite Male 76+ kg	
		M	Busi Lorenzo	Junior Kumite Male -55 kg	
	SD66419	M	CAFISO EDOARDO	U14 Kumite Male -45 kg	
		M	Caiata Antonio	U14 Kumite Male +55 kg	
	ITA04491	M	CALABRESE FILIPPO	Junior Kata Male	
	ITA04499	M	Calabrese Luca	U21 Kata Male	
		M	Calandi Roberto	Junior Kumite Male -76 kg	
		M	CALDARELLI Fortunato	Cadet Kata Male	
		M	CALDARESE GENNARO	U14 Kumite Male -45 kg	
	ITA03619	M	Caleffi Alessio	U21 Kumite Male -75 kg	
		M	CALIFANO EMANUELE	Junior Kumite Male -61 kg	
		M	Camanzo Salvatore	Junior Kata Male	
		M	CAMEROTA ISAAC MATTIA	Cadet Kumite Male -63 kg	
		M	Capizzi Michele	U14 Kumite Male +55 kg	
		M	CAPONERA Emanuele	Junior Kata Male	
	SD51449	M	CAPRITTI ENEA	Junior Kumite Male -76 kg	
		M	Caracateanu Radu cristian	Cadet Kata Male	
	SD15400	M	Caraccia Filippo	U14 Kata Male	
		M	Careglio Niccolò	U14 Kumite Male -45 kg	
		M	Caridei Christian	Junior Kumite Male -76 kg	
		M	CARRABINO Alessandro	U21 Kumite Male -60 kg	
		M	Carrara Matteo	Cadet Kumite Male -57 kg	
		M	CARRARESI ALESSANDRO	Junior Kumite Male -76 kg	
		M	Carrozzino Luca	Junior Kata Male	
		M	Casanova Francesco Pio	U14 Kumite Male -45 kg	
	ITA483229	M	CASTELLANO FEDERICO	Cadet Kumite Male -57 kg	
		M	Castellano Michele	Junior Kumite Male -76 kg	
		M	Castellazzi Simone	U14 Kumite Male +55 kg	
		M	CAVASIN ELIA	U21 Kumite Male -67 kg	
		M	CELENTANO ANTONIO	Junior Kumite Male -55 kg	
		M	Cenci Diego	Cadet Kata Male	
	ITA483230	M	CERSOSIMO ALESSANDRO	U14 Kumite Male -55 kg	
		M	CHIESA BRIAN	Cadet Kumite Male -63 kg	
		M	Cialente Federico	Cadet Kumite Male -70 kg	
		M	Ciavarella Riccardo	Junior Kumite Male -61 kg	
		M	Cinagli Federico	Junior Kumite Male -68 kg	
		M	Cioè Federico	U21 Kumite Male -67 kg	
	ITA506861	M	COERO ANDREA	U14 Kumite Male -40 kg	
	ITA04280	M	colonnese federico	U21 Kumite Male -75 kg	
		M	COMENDULLI LEONARDO	U14 Kumite Male -50 kg	



Karate1 Youth League - Venice 2024



ENTRIES BY NATIONAL FEDERATION

As of 8 DEC 2024

Country Code	ID	Gender	Name	Event	Seed
ITA		M	confuorto umberto	U21 Kumite Male 84+ kg	
		M	Conti Alessandro	Cadet Kumite Male 70+ kg	
		M	Conversini Simone	U14 Kumite Male -55 kg	
	ITA03836	M	COPPOLA ALESSANDRO	U21 Kumite Male -75 kg	
		M	COPPOLA GAETANO PIO	Cadet Kumite Male -52 kg	
		M	Corradi Matteo	U14 Kumite Male -55 kg	
		M	Cortese Erik	U14 Kumite Male -45 kg	
		M	Corvaglia Samuele	U21 Kata Male	
		M	Corvaglia Simone	U14 Kata Male	
	ITA04186	M	COSCI GIUSEPPE	U21 Kata Male	
		M	COSTANZO ANDREA	U14 Kumite Male -40 kg	
		M	Coviello Simone	U14 Kumite Male -55 kg	
		M	Crasti Alessandro	Cadet Kumite Male -57 kg	
		M	CUPCEA NIKITA	U14 Kumite Male +55 kg	
		M	DAN CHRISTIAN RICCARDO	Junior Kumite Male -61 kg	
		M	Debenedetti ANDREA	U14 Kumite Male -45 kg	
	ITA005616	M	DELLUOMO DAVIDE	Cadet Kata Male	
		M	DEL GRECO JACOPO	U14 Kumite Male -50 kg	
		M	Del Moro Diego	U14 Kumite Male -45 kg	
		M	DEL SEPPIA GIACOMO	Cadet Kumite Male 70+ kg	
	ITA04429	M	Del Seppia PIETRO	U21 Kumite Male -84 kg	
		M	De Chirico Paolo	U21 Kumite Male -75 kg	
		M	De Meo Marco	Cadet Kata Male	
	ITA04250	M	De Pascalis Devis	U21 Kumite Male -67 kg	
		M	DE PASQUALE MICHELE	Junior Kumite Male -55 kg	
		M	DE PETRIS ALESSIO	U14 Kumite Male -50 kg	
		M	De Rosa Emanuele	Cadet Kumite Male 70+ kg	
	ITA005615	M	DE SANCTIS RICCARDO	Cadet Kata Male	
		M	DE SIMONE ALESSIO	Cadet Kumite Male -52 kg	
		M	De Simone Emanuele	U21 Kumite Male -75 kg	
		M	De Simone Paolo	Junior Kumite Male -61 kg	
	ITA04476	M	De Stefano Emanuele	Junior Kumite Male -61 kg	
		M	DIDONI LORENZO	U14 Kumite Male -50 kg	
	ITA04577	M	DIGLIO Michele	U21 Kumite Male -67 kg	
		M	Dignoti Sebastiano	U14 Kumite Male -40 kg	
		M	Di ciommo Luca	U14 Kumite Male +55 kg	
		M	Di Fonte Nicolas	Cadet Kumite Male -63 kg	
	ITA04489	M	DI LEMME ALESSANDRO	Junior Kumite Male -61 kg	
		M	Di Maio Tommaso	Junior Kumite Male -61 kg	
		M	Di Mattia Tommaso	Junior Kumite Male 76+ kg	
		M	DI MICHELE RAIN	Cadet Kumite Male -52 kg	
		M	Di nardo Mattia	Cadet Kumite Male -52 kg	
		M	Di Naro Gabriele	U14 Kumite Male -40 kg	
		M	DI NOIA MARCO	U21 Kumite Male -67 kg	
	ITA04235	M	Di Rubba Luigi	Junior Kata Male	
		M	Domi Saimon	Junior Kumite Male -76 kg	
		M	DORIA MATTEO	Junior Kumite Male -68 kg	
	ITA04430	M	DOVERA GABRIELE	U21 Kumite Male -84 kg	



Karate1 Youth League - Venice 2024



ENTRIES BY NATIONAL FEDERATION

As of 8 DEC 2024

Country Code	ID	Gender	Name	Event	Seed
ITA		M	Duca Leonardo	Junior Kumite Male -55 kg	
		M	Durante Christian Ugo	U14 Kumite Male -45 kg	
	ITA02940	M	D ANNA ANDREA	U21 Kumite Male -67 kg	
		M	D Auria Luca	U14 Kata Male	
		M	D'AUTORIO IGOR	U14 Kata Male	
	ITA04223	M	ederar karim	U21 Kata Male	
		M	ESPOSITO Nicola	Cadet Kumite Male 70+ kg	
	ITA484830	M	EZZA LEONARDO	U14 Kata Male	
		M	FALCETTA ANDREA	Cadet Kumite Male 70+ kg	
		M	FANTINI FRANCESCO	Cadet Kumite Male -70 kg	
		M	FASTIGARI VALERIO LUIGI	Cadet Kumite Male 70+ kg	
	SD40336	M	Ferrarini Francesco	Cadet Kumite Male 70+ kg	
		M	Ferraris Giacomo	Cadet Kumite Male -52 kg	
		M	FERRI DANIELE	Cadet Kata Male	
		M	Fidolini Tommaso	Cadet Kumite Male -57 kg	
		M	FILIPPI GABRIELE	U14 Kumite Male +55 kg	
	ITA04200	M	FOSCHI SEBASTIAN	Junior Kumite Male -55 kg	
		M	FOTINO SAMUELE	U14 Kumite Male +55 kg	
		M	FRANCO ANTONIO	Junior Kumite Male 76+ kg	
		M	FRATTINA ANDREA DARIO	U14 Kumite Male -50 kg	
		M	Freda Matteo	Cadet Kata Male	
		M	Furlan Leonardo	Junior Kata Male	
	ITA04238	M	Fuscagni Alex	U21 Kata Male	
		M	gagliardo salvatore	Junior Kumite Male -68 kg	
		M	GALASSO Lorenzo	U21 Kumite Male -60 kg	
		M	Galeotti Thomas	U21 Kata Male	
	SD71701	M	Gallo Alessio	U21 Kumite Male -75 kg	
		M	GENOCCHIO ALEX	U14 Kumite Male -50 kg	
		M	Genocchio Manuel	Junior Kumite Male -76 kg	
		M	GENTA Jacopo	Junior Kumite Male -61 kg	
		M	Gentili Mathias	Junior Kumite Male -61 kg	
	SD61485	M	GIACOMELLI DANIELE	U21 Kumite Male -75 kg	
	ITA04533	M	GIGLIOTTA GIUSEPPE	Junior Kumite Male -68 kg	
		M	Giliberti Gianmarco	U14 Kata Male	
		M	GIORGINI ADAMO	Cadet Kumite Male -57 kg	
		M	GIORGINI ALESSANDRO	Cadet Kumite Male -63 kg	
		M	Giovagnoni Goele	U21 Kata Male	
		M	Giuliani Achille	U14 Kumite Male -55 kg	
		M	Giuliani Jacopo	Cadet Kumite Male -57 kg	
		M	GIULIANO MATTEO	Junior Kumite Male -55 kg	
		M	GIULIANO SIMONE	Cadet Kumite Male -70 kg	
		M	GIUSTINIANO ALESSIO	Cadet Kata Male	
	ITA04554	M	Golinelli Federico	Junior Kumite Male -55 kg	
		M	Gotti Thomas	U14 Kumite Male -55 kg	
		M	Guarino Andrea	Junior Kumite Male -55 kg	
		M	Guderzo Francesco	U14 Kumite Male +55 kg	
	ITA04556	M	GUERRA RICCARDO	Junior Kumite Male -61 kg	
		M	Guglielmino Riccardo	U14 Kumite Male -45 kg	



Karate1 Youth League - Venice 2024



ENTRIES BY NATIONAL FEDERATION

As of 8 DEC 2024

Country Code	ID	Gender	Name	Event	Seed
ITA		M	Guida Samuele	Junior Kumite Male -61 kg	
		M	Gullo Giuseppe Gianmatteo	U14 Kumite Male -40 kg	
		M	Guzzetti Riccardo	U14 Kata Male	
		M	Iacob Alessio	U14 Kumite Male +55 kg	
		M	Iacobacci Amedeo Junior	Cadet Kumite Male -52 kg	
	ITA03876	M	Iannuzzi Mario	U21 Kumite Male -75 kg	
		M	INCOLLINGO ANGELO MATTEO	Cadet Kumite Male 70+ kg	
		M	Ingenito Angelo	U21 Kumite Male -67 kg	
	ITA04214	M	Ingenito Gennaro	Junior Kumite Male -76 kg	
	ITA03014	M	JIGAU MARCO LEONARDO	U21 Kata Male	
	ITA04273	M	KOROTENKO MICHAIL	Junior Kumite Male -68 kg	
		M	LABIB RAMZY REZK ALVIN	U14 Kumite Male -55 kg	
		M	Laboranti Luca	Cadet Kata Male	
		M	Lambro Luigi	U14 Kumite Male -50 kg	
		M	Lattanzi Cristian	Cadet Kata Male	
		M	LAVACCA DANIELE	Junior Kumite Male -68 kg	
		M	LEGNOME ANGELO	Cadet Kumite Male -52 kg	
		M	LEGRENZI FILIPPO	Cadet Kata Male	
	ITA483250	M	Lella Qian Yue Daniele	Cadet Kumite Male -52 kg	
		M	LEONE GIUSEPPE	U21 Kumite Male -67 kg	
	ITA04473	M	LIBERTI Santino	Junior Kumite Male 76+ kg	
		M	Licata Andrea	U14 Kumite Male -55 kg	
		M	Licciardi Simone	Cadet Kumite Male -63 kg	
	ITA04510	M	Liguori Cristian	Junior Kumite Male -68 kg	
		M	LIOI ANDREA	U14 Kumite Male -50 kg	
		M	Ileshaj gabriele	U21 Kumite Male -84 kg	
	ITA04202	M	Loffredo Francesco	U21 Kumite Male -67 kg	
	ITA02955	M	Lorenzetti Tommaso	U21 Kumite Male -67 kg	
		M	LORENZO DONOFRIO	Cadet Kumite Male -70 kg	
	ITA03635	M	LUCIANI DAVIDE	U21 Kumite Male -84 kg	
		M	Luciani Federico	U14 Kumite Male -45 kg	
		M	Luciani Manuel	Cadet Kumite Male -57 kg	
		M	Lupattelli Andrea	U21 Kumite Male -67 kg	
		M	Lussignoli Diego	Junior Kumite Male -68 kg	
		M	Macchion Alessandro	U14 Kumite Male -55 kg	
	ITA04443	M	Magnani Riccardo	Junior Kumite Male 76+ kg	
	ITA04686	M	MAGNELLI EMANUELE	U21 Kumite Male 84+ kg	
		M	MAGNELLI LEONARDO	U14 Kumite Male -50 kg	
		M	Magri Matteo	Cadet Kumite Male 70+ kg	
	ITA04424	M	MALLARDI Alessio	U21 Kumite Male -60 kg	
		M	MARCHESE LUCIO	Cadet Kata Male	
		M	Marchetti Enrico	U14 Kata Male	
		M	Mariani Lorenzo	Junior Kumite Male -68 kg	
		M	Marinelli Alessandro	U14 Kumite Male -55 kg	
		M	Marinelli Rocco	Cadet Kumite Male -63 kg	
		M	MARINI MATTEO	Cadet Kumite Male -57 kg	
	ITA04469	M	Marino ANGELO	U21 Kumite Male -75 kg	
		M	Marino Antonio	U14 Kumite Male +55 kg	



Karate1 Youth League - Venice 2024



ENTRIES BY NATIONAL FEDERATION

As of 8 DEC 2024

Country Code	ID	Gender	Name	Event	Seed
ITA		M	Marino Emanuele	Cadet Kumite Male -57 kg	
		M	Marino Fernando	U21 Kumite Male 84+ kg	
		M	Marinone Lorenzo	Cadet Kumite Male 70+ kg	
		M	Marrazzo Mario	Junior Kumite Male -68 kg	
		M	Marrucci Filippo	U14 Kumite Male -50 kg	
		M	Martellini Nicholas	U21 Kumite Male 84+ kg	
		M	Martini Simone	Junior Kumite Male -68 kg	
	ITA04187	M	MATACCHIONI LUIGI	U21 Kata Male	
		M	Materano Daniele	Junior Kumite Male 76+ kg	
		M	MATTEOTTI MARCO	U14 Kumite Male -55 kg	
	ITA02987	M	Mazzarello Andrea	U21 Kata Male	
		M	mazzotta edoardo	Cadet Kumite Male -63 kg	
		M	Mearini Gioele	U21 Kumite Male -60 kg	
		M	megale antonino	U14 Kumite Male -45 kg	
		M	Merluzzo Antonio	Cadet Kata Male	
		M	Milano Nicola	U14 Kata Male	
		M	MINEO LORENZO	Cadet Kata Male	
		M	MIRTO ALESSANDRO	U21 Kata Male	
		M	mocanu adrian nicolae	U14 Kata Male	
		M	Moffa Antonio	U14 Kumite Male -40 kg	
		M	Moffa Luigi	Cadet Kumite Male -52 kg	
		M	MOINI FILIPPO	Junior Kumite Male -55 kg	
		M	MOLIN LUCA	U14 Kata Male	
	ITA04412	M	MONDINI LUCA	Junior Kumite Male -76 kg	
		M	MONDO BRANCHI MATTEO	Junior Kumite Male -55 kg	
	ITA04530	M	Monego Edoardo	U21 Kumite Male 84+ kg	
		M	MONICO LEONARDO	Cadet Kumite Male -57 kg	
		M	Montanari Valerio	Junior Kumite Male -76 kg	
		M	MONTANARI VITO	Cadet Kumite Male 70+ kg	
		M	Monza Andrea	U21 Kata Male	
	SD203995	M	Morelli Filippo	Cadet Kata Male	
		M	MORELLI GABRIELE	U21 Kumite Male -67 kg	
		M	MORESCO Andrea	U14 Kumite Male -40 kg	
		M	MORETTI EROS	Cadet Kata Male	
		M	Moretti Leonardo	U14 Kumite Male +55 kg	
	ITA04493	M	Moretti Oscar	Junior Kata Male	
	ITA02968	M	MOSCATELLI SAMUELE	U21 Kata Male	
		M	Mostarda Ettore	Junior Kumite Male 76+ kg	
		M	Mungiguerra Giuseppe	U14 Kumite Male +55 kg	
		M	Mura Matteo	Cadet Kumite Male -52 kg	
		M	MURACCHIOLI LUCA	U14 Kata Male	
		M	MUSANTI ENEA	Junior Kumite Male -61 kg	
		M	Naglein Giorgio	U14 Kumite Male +55 kg	
		M	NAPOLI FRANCESCO	U21 Kumite Male -75 kg	
	ITA435465	M	NARDACCIO MATTEO	Cadet Kata Male	
		M	Narducci Nicolò	U14 Kata Male	
		M	Nasser Diego	U14 Kumite Male -55 kg	
		M	Nasser Paolo	Junior Kumite Male -61 kg	



Karate1 Youth League - Venice 2024



ENTRIES BY NATIONAL FEDERATION

As of 8 DEC 2024

Country Code	ID	Gender	Name	Event	Seed
ITA		M	NASSO ANDREA	Cadet Kumite Male -70 kg	
	ITA04407	M	Navarra Francesco	Junior Kumite Male -61 kg	
		M	NAZZARO Lorenzo	Junior Kumite Male -68 kg	
		M	NICCHI SAMUELE	U14 Kumite Male +55 kg	
		M	Nieddu Jacopo	U14 Kumite Male -45 kg	
		M	NOBILE SIMONE	U14 Kumite Male -50 kg	
		M	Notturmo Jacopo	Cadet Kumite Male -57 kg	
		M	Nuzzi Giuseppe	Cadet Kumite Male 70+ kg	
	ITA04262	M	ODELLO ANDREA	Junior Kumite Male -68 kg	
	ITA04419	M	Ollagnero Giovanni	Junior Kata Male	
		M	ONORATI MATTIA	Junior Kumite Male -68 kg	
		M	PAGANO CARMINE	U14 Kumite Male +55 kg	
		M	PAGLIONICO VITTORIO	U14 Kumite Male -50 kg	
	ITA435470	M	PAGNOTTA ALESSANDRO	U21 Kumite Male -60 kg	
		M	PAKOCS PATRICK	Cadet Kumite Male 70+ kg	
		M	PALOMBARO FRANCESCO	Cadet Kumite Male -63 kg	
	ITA483232	M	PANARO ALESSANDRO	Cadet Kumite Male -57 kg	
		M	Paoletti Mattia	U21 Kumite Male -67 kg	
		M	Paoletti Niccolò	Junior Kumite Male -55 kg	
		M	Pappalardo Simone	U14 Kumite Male -55 kg	
	ITA03831	M	Pappalardo Vincenzo	U21 Kata Male	
		M	Paraboschi Matteo	Junior Kata Male	
		M	Parretta Filippo	U14 Kumite Male -55 kg	
		M	Pascale Bruno	U14 Kumite Male +55 kg	
		M	Passeri Salvatore	U14 Kumite Male -55 kg	
		M	PAVAN SEBASTIANO	Cadet Kata Male	
	ITA04267	M	Pelagalli Matteo	U21 Kumite Male -60 kg	
	ITA04474	M	PELAGGI Agostino	Junior Kumite Male 76+ kg	
		M	Perini Thomas	U14 Kata Male	
		M	Pezzei Fabian	U21 Kumite Male -84 kg	
		M	PEZZOTTI FRANCESCO	U14 Kumite Male -50 kg	
	ITA02898	M	PEZZOTTI GABRIELE	U21 Kumite Male -84 kg	
		M	PIAZZA FRANCESCO	Cadet Kumite Male -57 kg	
	ITA04263	M	Pica Gian Lorenzo	U21 Kumite Male -67 kg	
		M	Piccinini Giulio	U14 Kumite Male +55 kg	
		M	PIEMONTE GABRIEL	U21 Kumite Male -60 kg	
		M	PIERBATTISTI RICCARDO	U21 Kumite Male -60 kg	
	ITA03001	M	Pignatti Francesco	U21 Kumite Male -67 kg	
		M	Pilotto Nicolò	Junior Kata Male	
		M	PINCIO NICHOLAS	U14 Kumite Male -50 kg	
		M	Pinna Ivan	Cadet Kata Male	
		M	Pinna Maurizio	U14 Kumite Male +55 kg	
		M	PINTO ALESSIO	Junior Kata Male	
		M	Piscopo Loris	U21 Kumite Male -75 kg	
		M	Poenaru Alessio	U14 Kumite Male -55 kg	
		M	Polistena Andrea	Cadet Kumite Male -63 kg	
	ITA03045	M	Polsinelli Guido	U21 Kata Male	
		M	pontassuglia francesco	Cadet Kumite Male -63 kg	



Karate1 Youth League - Venice 2024



ENTRIES BY NATIONAL FEDERATION

As of 8 DEC 2024

Country Code	ID	Gender	Name	Event	Seed
ITA		M	Pontil Scala Lorenzo	U14 Kumite Male -50 kg	
		M	PRAVATO ALESSANDRO	U14 Kumite Male -45 kg	
		M	Privitera Antonino Pio	Cadet Kumite Male -52 kg	
		M	Privitera Victor	U14 Kumite Male -55 kg	
	ITA03475	M	PROPIZIO PAOLO	U21 Kumite Male -67 kg	
		M	PULLIERO ALESSANDRO	Junior Kumite Male -76 kg	
	SD52808	M	Putelli Nicolò	Junior Kata Male	
		M	QUARANTA ANDREA	U14 Kumite Male +55 kg	
		M	Quaranta Simonluca	Cadet Kumite Male 70+ kg	
		M	QUINTAVALLE GABRIELE	U14 Kumite Male +55 kg	
		M	RABIEA RAIAN FARGHALI HOSSINI FARGHALI	Cadet Kumite Male -57 kg	
		M	RAGONE MATTIA	U14 Kumite Male -45 kg	
		M	RAMOS MATT STEVEN AUGUSTIN	U21 Kumite Male -67 kg	
		M	Rapis Massimo	Junior Kata Male	
		M	Realini Niccolò	Junior Kumite Male 76+ kg	
		M	Redondi Alessandro	Cadet Kumite Male 70+ kg	
	ITA03027	M	RICCARDI VITTORIO	U21 Kumite Male -75 kg	
		M	Righetti Simone	Cadet Kumite Male 70+ kg	
		M	Risito Matteo	Junior Kumite Male 76+ kg	
	ITA03015	M	RISSO LEANDRO	U21 Kumite Male -60 kg	
		M	Rizzati Thomas	U21 Kumite Male -75 kg	
		M	Rizzo Alessandro	Junior Kumite Male 76+ kg	
		M	rodà nicolas	Cadet Kumite Male -63 kg	
		M	Romagnoli Emanuel	Junior Kata Male	
		M	ROMANO GABRIELE	Cadet Kumite Male 70+ kg	
		M	Rorato Tommaso	Cadet Kumite Male -63 kg	
	ITA03648	M	Rosciglioni Jonathan	U21 Kumite Male 84+ kg	
		M	ROSIELLO GIUSEPPE	U21 Kata Male	
		M	ROSIELLO Marco	Cadet Kata Male	
		M	ROSSANO ANTONIO CLAUDIO	U14 Kumite Male +55 kg	
		M	ROSSI Edoardo	U14 Kata Male	
	ITA005613	M	ROSSI FEDERICO	Junior Kata Male	
	ITA04278	M	Rossi Francesco	U21 Kata Male	
		M	Rossi Francesco Alberto	U14 Kumite Male -50 kg	
	ITA03076	M	Rossini Gabriele	U21 Kumite Male -84 kg	
	ITA03828	M	Rufini Alessio	U21 Kumite Male -67 kg	
	ITA03827	M	Rufini Samuele	U21 Kumite Male -67 kg	
		M	RUOCCO ARMANDO	Cadet Kumite Male -63 kg	
		M	Russo Antonio	Cadet Kumite Male -70 kg	
		M	RUSSOMANNO GIOELE ANTONIO	Junior Kumite Male -68 kg	
	ITA03865	M	Sabatino Christian	U21 Kumite Male -60 kg	
	ITA03807	M	Sacco Gabriele	U21 Kumite Male -84 kg	
		M	SALVATI ADRIANO	U21 Kumite Male -84 kg	
		M	SANTAMATO ROBERTO	U21 Kumite Male 84+ kg	
		M	SAPONARO GABRIELE	U14 Kumite Male -45 kg	
		M	Scanacapra Leonardo	U14 Kumite Male -50 kg	
		M	Scarano Antonio	Junior Kumite Male -68 kg	



Karate1 Youth League - Venice 2024



ENTRIES BY NATIONAL FEDERATION

As of 8 DEC 2024

Country Code	ID	Gender	Name	Event	Seed
ITA		M	SCARICO MARIO	U14 Kumite Male +55 kg	
		M	SCIANNELLI GIULIO	Junior Kata Male	
		M	SCRIMIERI ANTONIO	U14 Kumite Male -40 kg	
		M	SCUGLIA MASSIMO	U14 Kumite Male +55 kg	
		M	Segantini Andrea	Cadet Kumite Male -57 kg	
	ITA04226	M	SERGI FRANCESCO	U21 Kata Male	
		M	Simoni Emanuele	Cadet Kumite Male -57 kg	
		M	Sini Edoardo	Cadet Kumite Male -70 kg	
		M	solomon gleb	Cadet Kumite Male -63 kg	
	SD66418	M	Somaschini Filippo	U14 Kumite Male -40 kg	
		M	SORCI SAMUELE	Cadet Kumite Male -52 kg	
	ITA03002	M	SPAMPINATO MARCO GAETANO	U21 Kumite Male -60 kg	
		M	Spartà Alessio	U14 Kumite Male +55 kg	
		M	Speranza Alessio	Junior Kata Male	
		M	Spilinga Cristian	Junior Kumite Male -55 kg	
		M	SPINESI LEONARDO	Cadet Kumite Male -63 kg	
		M	Sportella Raffaele	U14 Kumite Male -40 kg	
		M	SQUILLANTE GUIDO	U21 Kumite Male -60 kg	
		M	STARACE ANDREA	U14 Kumite Male -45 kg	
		M	STORNAIUOLO GAETANO	U14 Kumite Male +55 kg	
		M	strangio giulio	Junior Kumite Male -76 kg	
		M	Talarico Maurizio	U14 Kumite Male -45 kg	
		M	Tamberi Alessandro	Junior Kumite Male -76 kg	
		M	TASSAN GURLE MICHELE	U14 Kumite Male -50 kg	
		M	TASSONE CALDIN ALVISE	U14 Kumite Male +55 kg	
		M	Todesca Alfonso	U14 Kumite Male -40 kg	
		M	TOMMASINO ALMERICO	Junior Kumite Male -68 kg	
	ITA04449	M	TONIOLO ALVISE	Junior Kumite Male -68 kg	
	ITA04207	M	TORRE CRISTIAN	U21 Kumite Male -75 kg	
		M	TORTELLI LEONARDO	Cadet Kumite Male 70+ kg	
	ITA03801	M	Torti Lorenzo	U21 Kumite Male -67 kg	
	ITA04519	M	TRAUNINI SIMONE	Junior Kata Male	
		M	Trefoloni Alessio	U21 Kumite Male -75 kg	
		M	Treggia Tommaso	Cadet Kumite Male -52 kg	
		M	TREVISAN MATTIA	U14 Kumite Male -45 kg	
		M	TRIDENTE GIANLUIGI	U14 Kumite Male -55 kg	
		M	Trotta Riccardo	U21 Kumite Male -67 kg	
		M	TURCATO GIACOMO FILIPPO	Cadet Kata Male	
		M	Uccellari Ludovico	U14 Kumite Male +55 kg	
		M	Ulqinaku Leonardo	Junior Kumite Male 76+ kg	
	ITA04236	M	Ungaretti Gabriele	U21 Kumite Male -75 kg	
		M	VACCA Matteo	Cadet Kumite Male -52 kg	
		M	Vacca Thomas	U21 Kata Male	
		M	Vampa Gabriel	U14 Kumite Male +55 kg	
		M	VARRICCHIO LUCA	U14 Kumite Male -45 kg	
		M	Vecchiotti Riccardo	Cadet Kumite Male 70+ kg	
		M	Venosta Fabio	U14 Kumite Male +55 kg	
		M	Ventrone Mattia	U21 Kumite Male -75 kg	



Karate1 Youth League - Venice 2024



ENTRIES BY NATIONAL FEDERATION

As of 8 DEC 2024

Country Code	ID	Gender	Name	Event	Seed
ITA		M	Vergati Giuseppe	U21 Kumite Male -67 kg	
		M	Verrastro Riccardo	Junior Kumite Male -76 kg	
		M	VILLANI MARIO	U14 Kumite Male -55 kg	
	ITA03067	M	Villano Cristian	U21 Kata Male	
		M	VIPERA LORENZO	Cadet Kumite Male -63 kg	
		M	Zambotto Nicolò	Junior Kata Male	
	ITA04411	M	ZANELLI FILIPPO	Junior Kumite Male -68 kg	
		M	ZANET THOMAS	U14 Kata Male	
	ITA04500	M	Zanirato Francesco	U21 Kata Male	
		M	Zanni Federico	Junior Kumite Male -61 kg	
	ITA03019	M	ZAPPONE ANTONIO	U21 Kumite Male -84 kg	
	ITA03062	M	Zelante Nunzio	U21 Kata Male	
		M	Zhou Marco	Junior Kata Male	
		M	Zinno Alessandro	Cadet Kumite Male -63 kg	
		F	Abenante Laura	Junior Kumite Female -48 kg	
		F	Addesa MariaLuisa	U14 Kumite Female 52+ kg	
		F	Agostinelli Ludovica	U21 Kumite Female -68 kg	
		F	Agostini Matilde	Cadet Kumite Female 61+ kg	
		F	Aloisio Giada	Junior Kumite Female -59 kg	
		F	Amabili Aurora	Cadet Kumite Female -61 kg	
		F	AMAGLIO GIULIA	U14 Kata Female	
		F	Amarante Francesca	U21 Kumite Female -61 kg	
		F	Anderlini Anna Clara	U14 Kumite Female 52+ kg	
		F	ANGHEL ARIANNA ANDREEA	U14 Kumite Female -42 kg	
	ITA04698	F	ANSELMI CHIARA	Junior Kumite Female -66 kg	
		F	Apuzzo Aurora	Junior Kumite Female 66+ kg	
		F	ARCILESI VIRGINIA	U14 Kumite Female 52+ kg	
		F	arena benedetta	U14 Kumite Female -42 kg	
		F	arena federica	Cadet Kumite Female -54 kg	
		F	Arena Mariachiarà	U14 Kumite Female -52 kg	
	ITA04478	F	Ariosto Myriam	U21 Kumite Female -55 kg	
		F	AUDIA ASIA	Cadet Kata Female	
		F	Azzena Bianca	U14 Kumite Female -52 kg	
	ITA04437	F	BACCHINI CHIARA	Junior Kata Female	
		F	BALLABIO DELIA	Cadet Kumite Female 61+ kg	
		F	BALLARIN GINEVRA	U14 Kumite Female 52+ kg	
		F	Banfi Azzurra	Cadet Kumite Female 61+ kg	
	ITA04562	F	BARONE MIRYAM FABIA	Junior Kumite Female -59 kg	
		F	belcastro gaia	Cadet Kumite Female -61 kg	
		F	BELLARDI MARIA SOFIA	Junior Kata Female	
		F	BENCIVENGA FRANCESCA	Junior Kata Female	
		F	BERETTA MARTINA	U14 Kata Female	
		F	Bertoldo Monica	Cadet Kumite Female -54 kg	
		F	BERTOLDO VERA	U14 Kumite Female 52+ kg	
		F	BIANCO ILARIA	Cadet Kumite Female -54 kg	
	ITA04240	F	Bifulco Asia	U21 Kumite Female -50 kg	
		F	Bigagli Viola	Junior Kumite Female -59 kg	
		F	BOCCHIOLA NOEMI	Junior Kumite Female 66+ kg	



Karate1 Youth League - Venice 2024



ENTRIES BY NATIONAL FEDERATION

As of 8 DEC 2024

Country Code	ID	Gender	Name	Event	Seed
ITA		F	Bon Greta	Cadet Kumite Female -61 kg	
	ITA04689	F	Boncori Sofia	Junior Kumite Female -53 kg	
	ITA03277	F	BOSCO ALICE	U21 Kumite Female -55 kg	
		F	BOSIO MATILDE	U21 Kumite Female -50 kg	
	SD71020	F	Bossi Alessandra	Junior Kumite Female -48 kg	
		F	Bouraya Sofia	Junior Kumite Female -59 kg	
		F	Brambilla Chiara	U21 Kata Female	
	ITA04569	F	Brandimarte Gioia	U21 Kumite Female -50 kg	
		F	Brotto Viola Germana	U14 Kumite Female -42 kg	
		F	BUGINI ALICE	Junior Kata Female	
		F	Buono Marta	U21 Kumite Female -68 kg	
	SD61410	F	burzo carolina	Junior Kumite Female -59 kg	
	SD61413	F	burzo francesca	U21 Kumite Female -55 kg	
		F	Butini Margherita	Cadet Kumite Female -54 kg	
		F	Calcagno Alice	Junior Kumite Female -48 kg	
		F	calin alexia viorica	Junior Kumite Female -48 kg	
		F	Campisi Soumia	Cadet Kumite Female 61+ kg	
		F	CAMPO ARIANNA	U14 Kumite Female -42 kg	
		F	Campobasso Aurora	U21 Kumite Female -61 kg	
		F	Caneva Sara	Junior Kumite Female -66 kg	
		F	CAPATTI GIADA	Junior Kumite Female -48 kg	
		F	CAPECE GINEVRA OLIMPIA	U14 Kumite Female -42 kg	
		F	Capone Bianca	Junior Kumite Female -53 kg	
		F	Cardaropoli Isabel	Cadet Kata Female	
		F	Caridei Carola	U14 Kumite Female 52+ kg	
		F	Carnimeo Patrizia	U14 Kumite Female -52 kg	
		F	Carotenuto Floriana	U14 Kata Female	
		F	CASCIOFERRO CARLA	Cadet Kumite Female -54 kg	
	ITA04692	F	Caselli Elisa Laetitia	Junior Kumite Female -48 kg	
		F	CASTELLANO ERIKA	Junior Kumite Female -66 kg	
		F	CATONA SILVIA	Junior Kumite Female -48 kg	
	ITA05404	F	CATTANEO ELISA	Junior Kumite Female -66 kg	
		F	Cavallaro Lara	U14 Kumite Female -42 kg	
		F	CECCHETTO LARA	U14 Kata Female	
		F	Cerchi Elisa	Cadet Kumite Female -54 kg	
		F	Cescut Emma	U14 Kumite Female -47 kg	
		F	Chakir Fatima Azahra	U14 Kumite Female -47 kg	
	ITA04224	F	CHEROUAQI BASMA	Junior Kumite Female -59 kg	
		F	CHIAPPARELLI GIADA	Junior Kumite Female -53 kg	
		F	chimisso maria	Junior Kumite Female -53 kg	
		F	Cimone Arianna	Junior Kumite Female 66+ kg	
		F	Cioccetti Andreina	Junior Kata Female	
		F	Cocca MariaLuigia	Junior Kumite Female -59 kg	
	ITA04298	F	COLLETTI EMMA	U21 Kumite Female -50 kg	
		F	Condemi Gaia	Junior Kumite Female -53 kg	
		F	Copercini Margherita	U14 Kata Female	
		F	Copercini Matilde	Junior Kumite Female -59 kg	
	ITA04266	F	Cornolò Giada	U21 Kumite Female -61 kg	



Karate1 Youth League - Venice 2024



ENTRIES BY NATIONAL FEDERATION

As of 8 DEC 2024

Country Code	ID	Gender	Name	Event	Seed
ITA		F	Correddu Nicole	Cadet Kumite Female 61+ kg	
		F	Coselli Linda	Junior Kata Female	
		F	CRAIU BIATRIS IONELA	Junior Kumite Female -53 kg	
	ITA04241	F	CRISTALLO RITA	Junior Kumite Female -59 kg	
		F	Crosatti Elisa	Junior Kumite Female -66 kg	
	ITA2181	F	Crucitti Francesca	Junior Kata Female	
		F	Crucitti Sofia	Cadet Kata Female	
		F	cumbo costanza	Junior Kumite Female -59 kg	
		F	Curto Martina	Junior Kumite Female -53 kg	
		F	CUZZOLINO MARIACONCETTA	U21 Kumite Female -68 kg	
		F	DALLAVALLE EVA	Cadet Kumite Female -54 kg	
		F	Dalle Fusine Maria Carlotta	U21 Kumite Female -68 kg	
		F	Dapas Vanessa	U21 Kumite Female -55 kg	
		F	Dellamico Gioia	Cadet Kata Female	
		F	Della Rosa Martina	Junior Kumite Female -59 kg	
		F	DELNEVO ALESSIA	Cadet Kumite Female -54 kg	
	ITA04269	F	DESIDERIO ANNA PIA	U21 Kumite Female -68 kg	
	ITA03043	F	Deste Federica	U21 Kumite Female -61 kg	
		F	Dettori Sabrina	U14 Kumite Female -47 kg	
	ITA03065	F	DE ANGELIS MARTINA	U21 Kumite Female -50 kg	
	ITA04255	F	DE FALCO ASIA	Junior Kumite Female -48 kg	
	ITA03632	F	DE GREGORIO GABRIELLA	U21 Kata Female	
		F	De Marchi Ludovica	U14 Kumite Female -42 kg	
	SD749997	F	De Pace Maria Luisa	Cadet Kata Female	
		F	DE PASQUALE SILVIA	U14 Kumite Female -52 kg	
		F	De Rosa Sofia	U21 Kumite Female 68+ kg	
	SD71232	F	De Simone Letizia	Junior Kumite Female -53 kg	
		F	De Vivo Annachiara	Cadet Kumite Female 61+ kg	
		F	De Vivo Ermelinda	Junior Kumite Female 66+ kg	
		F	Disarò Ginevra	Cadet Kumite Female -61 kg	
		F	DI BARI GEMMA	U21 Kumite Female 68+ kg	
	ITA-534808	F	DI CATALDO GAIA	U14 Kumite Female -52 kg	
		F	Di domenico Chiara	U21 Kumite Female -55 kg	
		F	Di Fiore Alessia	U14 Kumite Female -47 kg	
		F	Di Latte Gaia	U14 Kumite Female -47 kg	
		F	Di Lelio Elena	U21 Kata Female	
		F	Di Leo Noemi	Cadet Kumite Female -61 kg	
		F	Di Mare Lavinia	Cadet Kumite Female -47 kg	
		F	Di Maria Susanna	U21 Kumite Female -68 kg	
		F	Di Mauro Asia	Cadet Kumite Female -47 kg	
		F	Di Rosa Rossella Benedetta	Junior Kata Female	
		F	Di stefano Lavinia	Cadet Kumite Female -61 kg	
		F	DOCIMO SARA	Cadet Kumite Female -61 kg	
	ITA04188	F	dominici roberta	Junior Kata Female	
		F	DOMINIJANNI ELISA	U21 Kata Female	
	ITA03322	F	DON ALICE	U21 Kumite Female -61 kg	
		F	Donati Elena	U14 Kumite Female -52 kg	
	SD739449	F	Dublino Beatrice	Cadet Kata Female	



Karate1 Youth League - Venice 2024



ENTRIES BY NATIONAL FEDERATION

As of 8 DEC 2024

Country Code	ID	Gender	Name	Event	Seed
ITA	SD47416	F	Dublino Sofia	Junior Kata Female	
		F	DUCA GIORGIA	U21 Kumite Female -61 kg	
		F	DUTTO GIULIA	Junior Kumite Female -59 kg	
ITA04276		F	D Angelo Ludovica Luigia	Junior Kumite Female -53 kg	
		F	D AURELI FLAVIA	U21 Kumite Female 68+ kg	
ITA2111		F	D Onofrio Orsola	U21 Kata Female	
SD49017		F	ECCHILI GRAZIELLA ANNAEL	Junior Kumite Female -59 kg	
ITA04221		F	ederar miriam	U21 Kata Female	
ITA04444		F	El Asri Amina	Junior Kumite Female -59 kg	
ITA04445		F	El Asri khadija	Junior Kumite Female -59 kg	
		F	ESPOSITO Emilia	Cadet Kata Female	
ITA2669		F	FABBRI GIORGIA	U21 Kumite Female -55 kg	
		F	FASTIGARI VIOLA EMILIA	Cadet Kumite Female -54 kg	
		F	Federici Carola	U21 Kumite Female -50 kg	
		F	FERRA EMMA	Junior Kata Female	
ITA-534805		F	FERRATO ALESSIA	Cadet Kata Female	
ITA04410		F	FETTOLINI ERIKA	Junior Kumite Female -66 kg	
ITA04695		F	Fiume Matilde	Junior Kumite Female -59 kg	
ITA04406		F	FORCELLA ELEONORA	Junior Kata Female	
		F	FRIGENI MICHELA	Cadet Kata Female	
		F	Gabba Giada	U21 Kata Female	
SD66323		F	GABRIELE MIRIAM ELENA	Junior Kata Female	
		F	Galati Giulia	Junior Kumite Female -59 kg	
SD52734		F	GALATI VITTORIA	Cadet Kumite Female -47 kg	
		F	GANDOLA GRETA	Junior Kumite Female -59 kg	
		F	Gargiulo Terry	Cadet Kata Female	
		F	GATTA LINDA	Junior Kata Female	
		F	GAVIOLI MELISSA	U14 Kumite Female 52+ kg	
ITA04260		F	Genocchio Isabel	U14 Kumite Female 52+ kg	
		F	GENTA MICOL	U21 Kumite Female -50 kg	
		F	GIOMBI SOFIA	Junior Kata Female	
		F	GIORDANI Paola	U21 Kumite Female -68 kg	
		F	Girello Alessandra	Cadet Kumite Female -61 kg	
		F	GOZZINI LUCREZIA	U14 Kata Female	
		F	Gracco Morena	Junior Kumite Female 66+ kg	
ITA04505		F	GRANATIERO SOFIA	Junior Kumite Female -59 kg	
		F	GRANELLI GAIA	Cadet Kumite Female -47 kg	
ITA04253		F	Grazia Nicol	Junior Kata Female	
		F	GRAZIANI DIANA	Cadet Kumite Female -47 kg	
ITA02957		F	GRONCHI MATILDE	U21 Kumite Female -55 kg	
		F	GROSSI ALESSANDRA	Junior Kumite Female -48 kg	
ITA04185		F	GRUPPIONI ASIA	U21 Kata Female	
		F	GUALBERTI MELANIE	U14 Kata Female	
		F	Guarino Giulia	Cadet Kumite Female -61 kg	
ITA03867		F	Guazzaroni Alessandra	U21 Kumite Female -61 kg	
		F	Guerrini Alice	U21 Kumite Female -68 kg	
		F	GULOTTA GIOIA MARIA	Cadet Kumite Female -61 kg	
		F	HAMZA SARA	U14 Kata Female	



Karate1 Youth League - Venice 2024



ENTRIES BY NATIONAL FEDERATION

As of 8 DEC 2024

Country Code	ID	Gender	Name	Event	Seed
ITA		F	Herrero Libertad	U14 Kumite Female -52 kg	
		F	IANNONE ANDREANA	U14 Kata Female	
		F	Laiolo Serena	U21 Kumite Female -61 kg	
		F	LANDI ALESSIA	Junior Kumite Female -53 kg	
		F	Laouzai Yasmine	Cadet Kumite Female -54 kg	
		F	Lazzari Siria	Junior Kata Female	
		F	La Macchia Cristina	U21 Kata Female	
		F	LEGITTIMO LUDOVICA	Junior Kumite Female -48 kg	
		F	LENZONI EMMA	Cadet Kata Female	
		F	LEONI ADELE	Junior Kumite Female -53 kg	
		F	Lippi Ginevra	Junior Kumite Female -59 kg	
		F	LIVELLI GINEVRA	Cadet Kumite Female -54 kg	
		F	Lochi Samuela	U14 Kumite Female -47 kg	
	ITA04472	F	LOFFREDO Andrea Chiara	Junior Kumite Female -59 kg	
		F	LONGERI AURORA	Cadet Kumite Female -54 kg	
		F	LORENZON MATILDE	Junior Kumite Female -53 kg	
		F	Lucci Miriam	Junior Kumite Female -48 kg	
		F	LUCENTE LETIZIA	Junior Kumite Female -53 kg	
		F	LUCIANI SIRIA	Junior Kumite Female -53 kg	
		F	Lugato Maria Sofia	U21 Kumite Female 68+ kg	
		F	MACHETTI IRENE	Junior Kata Female	
	ITA03323	F	MAFFIZZOLI GAIA	U21 Kumite Female -61 kg	
		F	Maffizzoli Lisa	Junior Kumite Female -59 kg	
	ITA03537	F	MARCELLI ANNA	U21 Kata Female	
	ITA03539	F	Marchetti Giulia	U21 Kata Female	
	ITA04438	F	MARCONI MARIA	Junior Kata Female	
		F	Marenco Maya	Cadet Kumite Female -54 kg	
		F	MARINELLI GIULIA	U14 Kumite Female 52+ kg	
		F	MARRUCCI VALENTINA	Junior Kumite Female -53 kg	
		F	Martini Alice	U14 Kumite Female -42 kg	
	ITA03806	F	MARTURANO IRENE	U21 Kumite Female -61 kg	
	ITA04520	F	Masoch Mariachiara	U21 Kumite Female -50 kg	
	ITA03552	F	MASSARI GIORGIA	U21 Kumite Female -61 kg	
		F	MATTUGINI ESTER	Junior Kata Female	
		F	Mazzotta Noemi	Cadet Kumite Female 61+ kg	
		F	Mearini Rachele	Junior Kumite Female -53 kg	
	ITA04688	F	Mechi Gemma	Junior Kumite Female -66 kg	
	ITA04487	F	Mercuri Sofia	Junior Kumite Female -59 kg	
		F	MESAGLIO MARTINA	U21 Kata Female	
		F	MIKOL MININNI	U21 Kumite Female -68 kg	
		F	Milea Maya	Cadet Kumite Female -54 kg	
		F	Ministro Flavia	Cadet Kumite Female -54 kg	
		F	Moneghini Martina	Junior Kumite Female -53 kg	
		F	Montebello Carlotta	Junior Kumite Female 66+ kg	
		F	MORETTI ELENA MARIA	Junior Kata Female	
	ITA483231	F	MUCCIA SERENA	Cadet Kumite Female -47 kg	
	ITA03808	F	MUGNANI MIRIAM	U21 Kata Female	
		F	MURGIA ALESSIA	Junior Kumite Female -48 kg	



Karate1 Youth League - Venice 2024



ENTRIES BY NATIONAL FEDERATION

As of 8 DEC 2024

Country Code	ID	Gender	Name	Event	Seed
ITA		F	MURGIA ARIANNA	Cadet Kumite Female -47 kg	
		F	Murolo Francesca Pia	U21 Kumite Female 68+ kg	
		F	MUSOLINO SARA	Junior Kumite Female -53 kg	
		F	Musso Roberta	Cadet Kumite Female -61 kg	
		F	Naglein Emma	Cadet Kata Female	
		F	Nardi Chiara	U21 Kumite Female -55 kg	
		F	Natalini Giulia Ginevra	Cadet Kata Female	
		F	NEGRONE VIVIANA	U14 Kumite Female -42 kg	
		F	Novello Giada	U14 Kata Female	
	SD57222	F	Oberto Vivien	Cadet Kata Female	
		F	ONORI Sofia	Cadet Kumite Female 61+ kg	
		F	ORSETTI ANNA	Junior Kata Female	
		F	Ortu Rebecca	U21 Kumite Female -55 kg	
		F	Ortuso Alessia Maria	U14 Kumite Female 52+ kg	
		F	Pacani Sonila	Cadet Kumite Female -47 kg	
		F	Paddeu Emma	U14 Kata Female	
	ITA04248	F	PADOAN MARTINA	Junior Kata Female	
		F	Pagliari Martina	U21 Kata Female	
		F	Palombi Sofia	U14 Kumite Female -52 kg	
	SD51898	F	PALUMBO VITTORIA PIA	Junior Kumite Female 66+ kg	
		F	panasiti GIULIA	Cadet Kumite Female -47 kg	
		F	PARIMBELLI CAROLINA	Junior Kata Female	
		F	Paronetto Giorgia	Cadet Kumite Female -47 kg	
		F	PASIN MATILDE	Cadet Kumite Female 61+ kg	
		F	Passuello Caterina	U14 Kumite Female 52+ kg	
		F	PAVONE SOFIA	Cadet Kumite Female -47 kg	
		F	PEDRETTI ASIA	U14 Kumite Female 52+ kg	
		F	penso isotta	Junior Kumite Female -53 kg	
		F	Perandria Matilde	Cadet Kumite Female -61 kg	
	ITA03079	F	PERGOLESI ASIA	U21 Kumite Female 68+ kg	
	ITA03080	F	Pergolesi Aurora	U21 Kumite Female 68+ kg	
		F	PERINA CAMILLA	U21 Kumite Female -50 kg	
		F	Pertile Marta	Junior Kumite Female -66 kg	
		F	petruzziello nicole anna	Cadet Kumite Female -47 kg	
		F	petruzziello sophie giorgia	U14 Kata Female	
		F	PEZZOTTI ALESSIA	U14 Kumite Female 52+ kg	
		F	Piantini Caterina	U21 Kumite Female -55 kg	
		F	Piantini Lara	U14 Kumite Female 52+ kg	
		F	piazza giulia	Junior Kumite Female -59 kg	
		F	PIETRAMALA GRETA	Cadet Kumite Female 61+ kg	
		F	Pignatti Giulia	Cadet Kata Female	
		F	PIRRI MARIA	U14 Kumite Female -52 kg	
		F	Plutino Francesca	U21 Kumite Female 68+ kg	
		F	PONZO MILAI	U14 Kata Female	
		F	Porcaro Siria	Junior Kumite Female -66 kg	
	ITA03883	F	Portoghese Morena	U21 Kumite Female -68 kg	
	SD52109	F	Preda Giada	Junior Kata Female	
		F	Punta Micaela	Junior Kata Female	



Karate1 Youth League - Venice 2024



ENTRIES BY NATIONAL FEDERATION

As of 8 DEC 2024

Country Code	ID	Gender	Name	Event	Seed
ITA		F	QUARTERONI CARLA	U14 Kata Female	
		F	REBECCA ALBORINO	Junior Kumite Female 66+ kg	
		F	REINA FRANCESCA	Junior Kumite Female -59 kg	
		F	Reineri Olimpia	U14 Kumite Female -42 kg	
		F	RICCIARDI ANGELA	Cadet Kata Female	
		F	RICCIARDI ELISA	Cadet Kumite Female 61+ kg	
		F	rigoni clelia	U21 Kata Female	
		F	Rizzi Ariani Maria	U14 Kumite Female -42 kg	
		F	Rizzo Martina	U14 Kumite Female 52+ kg	
		F	Rocchi Asia	U14 Kata Female	
		F	ROSA COLOMBO Sofia	Junior Kumite Female -59 kg	
		F	Rosina Giulia	Cadet Kumite Female -54 kg	
		F	ROSSANO FEDERICA CARMELA	Cadet Kumite Female -61 kg	
		F	ROSSI Giulia	U21 Kata Female	
		F	ROSSI MICHELA	U14 Kumite Female -52 kg	
		F	Rovere Lisa	U14 Kumite Female -47 kg	
		F	Rovina Lisa	Junior Kata Female	
		F	Russo Emilie	Cadet Kata Female	
		F	Saccon Arianna	Junior Kata Female	
		F	Salvi Caterina	Junior Kumite Female -53 kg	
		F	Sangeorzan Mirabella	U14 Kumite Female -42 kg	
		F	Santori Vittoria	U14 Kumite Female -42 kg	
		F	Sanza Marie	Junior Kumite Female -53 kg	
		F	Sarais Sofia	Cadet Kumite Female -47 kg	
		F	SARI CHIARA	U21 Kumite Female 68+ kg	
		F	Sbabo Angelica	U21 Kumite Female -50 kg	
		F	Scarsi Alice	U14 Kumite Female -52 kg	
	ITA04458	F	Scaruffi Sara	Junior Kata Female	
	ITA03035	F	SCHICCHI ALESSANDRA	U21 Kumite Female -61 kg	
		F	SCLERANDI NOEMI	Junior Kumite Female -53 kg	
		F	SELLITTI ANNA	Cadet Kumite Female -54 kg	
		F	SELVA Sofia	Junior Kata Female	
	ITA04249	F	SERINELLI AURORA	U21 Kata Female	
	ITA04243	F	Servo Gaia	Junior Kumite Female -59 kg	
		F	SIGISMONDI NOEMI	U14 Kata Female	
		F	Simone Sofia	U14 Kumite Female -42 kg	
	ITA02892	F	Simonini Valentina	U21 Kumite Female -68 kg	
		F	Spampinato Giada	U14 Kumite Female -47 kg	
		F	SPATTI ALICE	U14 Kumite Female -42 kg	
		F	STAGI NICOLE	Cadet Kata Female	
	ITA04275	F	Stangerlin Sofia	U21 Kata Female	
		F	STELLA FEDERICA	U14 Kumite Female -52 kg	
		F	Stoppa Ginevra	U14 Kumite Female 52+ kg	
		F	Stramare Ilaria	U14 Kumite Female -42 kg	
		F	succi denise	U14 Kumite Female -47 kg	
		F	Tagliabue Silvia	Junior Kata Female	
	ITA02872	F	Tagliaferro Chiara	U21 Kata Female	
		F	Tancredi Matilde	Cadet Kumite Female -47 kg	



Karate1 Youth League - Venice 2024



ENTRIES BY NATIONAL FEDERATION

As of 8 DEC 2024

Country Code	ID	Gender	Name	Event	Seed
ITA		F	Tasca Eleonora	Cadet Kumite Female -47 kg	
		F	Tescari Kristel	U14 Kumite Female -47 kg	
		F	TIRABOSCHI LETIZIA	Junior Kumite Female 66+ kg	
		F	Todesca Carmen	U14 Kumite Female -47 kg	
	SD66345	F	TOGNETTI MARIA CHIARA	Junior Kata Female	
		F	ULINICI NICOLETA	Cadet Kumite Female 61+ kg	
	ITA04516	F	uniti noemi	Junior Kumite Female -48 kg	
		F	VALENTI JENNIFER	Cadet Kata Female	
		F	VALERIO LAURA	Cadet Kumite Female -54 kg	
		F	VALNEGRI ANNA	U14 Kumite Female -47 kg	
		F	vannini emma	Junior Kumite Female 66+ kg	
		F	Varva Anna	U14 Kata Female	
		F	Veronese Matilda	U14 Kumite Female -42 kg	
		F	VERRIA Martina	U21 Kumite Female -68 kg	
		F	VETTORETTI GIADA	Cadet Kumite Female -61 kg	
		F	Viacava Camilla	Cadet Kata Female	
		F	Viacava Caterina	U14 Kata Female	
	ITA04222	F	VIELMI ELISA	U21 Kata Female	
		F	Vietri Rebecca	Junior Kumite Female -48 kg	
		F	VILLA MARTINA	Junior Kata Female	
		F	zabska nicole	Cadet Kumite Female -61 kg	
		F	zaccaro aisha	U21 Kumite Female -55 kg	
		F	Zamberlan EMMA	U14 Kumite Female 52+ kg	
SD65185	F	Zodda Sofia Francesca	Cadet Kumite Female -47 kg		
ITA04518	F	ZORI ANNA	U21 Kata Female		
JAM	JAM02216	M	EVANS RASANDRE VALENTINO	Cadet Kata Male	
	JAM02216	M	EVANS RASANDRE VALENTINO	Cadet Kumite Male -57 kg	
JPN		M	Fukui Kanta	Cadet Kata Male	
		M	Sato Yuya	Junior Kata Male	
		M	SHINJO YUKITO	Junior Kata Male	
		F	ASATO COCORO	Cadet Kata Female	
		F	BANNO RINO	Cadet Kata Female	
		F	Hori Ria	Cadet Kata Female	
		F	OKAMOTO EMIRI	U14 Kata Female	
		F	SASAMOTO MOMONO	U14 Kata Female	
		F	SHINJO RINZE	Junior Kata Female	
KAZ	KAZ02648	M	Myrzaly Zhansultan	U21 Kumite Male -84 kg	
	KAZ02650	F	Sagynbek Laura	U21 Kumite Female -68 kg	
KOS	KOS03315	M	ADEMI LEART	U14 Kumite Male -50 kg	
	KOS03451	M	ARIFI AMMAR	Junior Kumite Male -76 kg	
	KOS02865	M	BAHTIRI RION	Cadet Kumite Male 70+ kg	
	KOS02730	M	BERISHA FUAT	Cadet Kumite Male -52 kg	
	KOS03441	M	CURRI AID	Cadet Kumite Male -63 kg	
	KOS03355	M	DAKU AMAR	U14 Kumite Male -40 kg	
	KOS03304	M	DALIPI MEVLAN	U14 Kumite Male -40 kg	
	KOS02551	M	HAMITI ENKEL	Cadet Kumite Male -70 kg	



Karate1 Youth League - Venice 2024



ENTRIES BY NATIONAL FEDERATION

As of 8 DEC 2024

Country Code	ID	Gender	Name	Event	Seed
KOS	KOS03322	M	ILIJAZI KHAN	U14 Kumite Male -45 kg	
	KOS02928	M	KRASNIQI ANUAR	U14 Kumite Male -40 kg	
	KOS03013	M	LATIFI TAULANT	Junior Kumite Male -61 kg	
	KOS03335	M	MALOKAJ SHKEMB	U14 Kumite Male -50 kg	
	KOS03333	M	MALOKAJ YLLI	U14 Kumite Male -50 kg	
	KOS03191	M	MORINA LEON	Junior Kumite Male 76+ kg	
	KOS003629	M	MUHAXHERI ERENK	U14 Kumite Male -50 kg	
	KOS02916	M	MUSTAFA HARIS	Junior Kumite Male -68 kg	
	KOS003631	M	MUSTAFA OMER	Junior Kumite Male -76 kg	
	KOS02902	M	OSMANI BLERAND	Junior Kumite Male 76+ kg	
		M	Peci Gent	Junior Kumite Male -76 kg	
	KOS03012	M	POLLOMI ALMIR	Cadet Kumite Male -57 kg	
	KOS003523	M	POLLOMI ILIR	Cadet Kumite Male -57 kg	
	KOS02723	M	SALIHU BLENDI	Cadet Kata Male	
	KOS03294	M	SELIMI YLL	U14 Kumite Male -55 kg	
	KOS2192	M	SHAQIRI ARTIOL	U21 Kumite Male -75 kg	
	KOS003589	M	VOKSHI ANIL	Junior Kumite Male -61 kg	
	KOS03061	F	AHMETI ELMA	Cadet Kumite Female -61 kg	
	KOS03299	F	BEKOLLI OLTA	U14 Kumite Female 52+ kg	
	KOS03302	F	BILALLI ELMA	Cadet Kumite Female -54 kg	
	KOS03356	F	BILALLI TUANA	U14 Kumite Female -42 kg	
	KOS03317	F	DRESHA RIGA	Cadet Kumite Female -47 kg	
	KOS2348	F	FONIQI ANILA	U21 Kumite Female -55 kg	
	KOS2252	F	GASHI VALEZA	U21 Kumite Female 68+ kg	
	KOS02932	F	HALIMI SUELA	Cadet Kumite Female -54 kg	
	KOS02858	F	HASANAJ DEA	Junior Kumite Female -53 kg	
	KOS03336	F	HASANAJ KLEA	U14 Kumite Female -42 kg	
	KOS2187	F	IBRAHIMI QENDRESA	Junior Kumite Female -59 kg	
	KOS02728	F	ISLAMI DINETA	U21 Kumite Female -61 kg	
	KOS02917	F	ISLAMI FINESA	Junior Kumite Female -66 kg	
	KOS03363	F	KELMENDI ALEA	U14 Kumite Female 52+ kg	
	KOS2125	F	LOKI ALMA	U21 Kata Female	
	KOS2387	F	MAHALLA DIELLZA	U21 Kumite Female 68+ kg	
	KOS02901	F	MAQEDONCI EMIRA	Cadet Kumite Female -47 kg	
	KOS02729	F	METOLLI EDA	Junior Kumite Female -53 kg	
	KOS2368	F	METOLLI EDINA	U21 Kumite Female -50 kg	
	KOS003633	F	REXHEPI DANINA	U14 Kumite Female -52 kg	
	KOS02937	F	REXHEPI LANIKA	Cadet Kumite Female -61 kg	
	KOS03298	F	SEJDIU REA	U14 Kumite Female 52+ kg	
	KOS003632	F	SHABANI ELJESA	Cadet Kumite Female -47 kg	
	KOS03292	F	SHERIFI ERINA	U14 Kumite Female -47 kg	
KOS03301	F	SYLEJMANI EZANA	Cadet Kumite Female -61 kg		
KOS02922	F	ZENUNI RINESA	Cadet Kumite Female -47 kg		
KUW	KUW02398	M	ALAJMI ABDALHADI	Junior Kumite Male -55 kg	
	KUW02261	M	ALAJMI ALI	U21 Kumite Male -60 kg	
	KUW02552	M	ALAJMI SALEM	U21 Kumite Male -60 kg	
	KUW003016	M	ALAZMI SAAD	Junior Kumite Male -55 kg	



Karate1 Youth League - Venice 2024



ENTRIES BY NATIONAL FEDERATION

As of 8 DEC 2024

Country Code	ID	Gender	Name	Event	Seed
KUW	KUW02404	M	ALDWUAILAH ABDULHADI	U21 Kumite Male -60 kg	
	KUW02265	M	ALHARBY YOSIF	U21 Kumite Male -60 kg	
	KUW003018	M	ALMURJAN ABDULAZIZ	U21 Kumite Male 84+ kg	
	KUW02264	M	ALMUTAIRI ABDULLAH	U21 Kumite Male -60 kg	
		M	Almutairi Eissa	Junior Kumite Male -55 kg	
	KUW02857	M	ALMUTAIRI SAAD	Cadet Kata Male	
	KUW02901	M	ALOTAIBI ABDULWAHAB	U14 Kumite Male -50 kg	
	KUW02905	M	ALQATAMI ABDULLAH	U14 Kumite Male -55 kg	
	KUW003017	M	ALTUWAIJRI BADER	U14 Kumite Male -50 kg	
	KUW02220	F	ALSULTAN SALAMH	U21 Kumite Female -50 kg	
LAT		M	Azans Maksims	Cadet Kumite Male -70 kg	
	LAT02515	M	Balzaris Miroslavs	Junior Kumite Male -55 kg	
		M	Durens Eduards	Cadet Kumite Male 70+ kg	
	LAT02552	M	Fomkins Ilja	U21 Kumite Male -75 kg	
		M	Galuzo Dmitrijs	Junior Kumite Male -55 kg	
	M	Holodovs Viktors	Junior Kumite Male -55 kg		
	M	Ivanovs Nikita	Cadet Kumite Male -52 kg		
	M	Jaudzems Gustavs	Cadet Kata Male		
	M	Jeparskis Timurs	Cadet Kumite Male -52 kg		
	M	Kalinovs Aleksandrs	Cadet Kumite Male -70 kg		
	M	Kisiks Zahars	U14 Kumite Male -50 kg		
	M	Kryzhevskiy Yan	U14 Kumite Male -55 kg		
	M	Kurmels Glebs	Junior Kumite Male -68 kg		
	M	Marimpolskiy Bohdan	U14 Kumite Male -40 kg		
	M	Mētra Rūdolfs	U14 Kumite Male -40 kg		
	M	Milovs Deniss	U14 Kumite Male +55 kg		
	M	Ozerovs Artjoms	U14 Kumite Male -50 kg		
	M	Paiders Gustavs Patriks	Cadet Kumite Male 70+ kg		
	M	Petersons Arsenijs	Cadet Kumite Male -52 kg		
	LAT2083	M	Pētersons Kristiāns Anrī	U21 Kumite Male -75 kg	
		M	Pumpurs Andrejs	U14 Kumite Male -55 kg	
	M	Sevcovs Artjoms	Cadet Kumite Male -70 kg		
	M	Sorohovs Kirills	Cadet Kumite Male -63 kg		
	M	Stilba Mihails	U14 Kumite Male -40 kg		
	M	Varcabjuks Arsenijs	Cadet Kumite Male -57 kg		
	M	Vietrins Maksims	Cadet Kumite Male -57 kg		
	LAT2141	M	Vorožeikins Leonids	Junior Kumite Male -76 kg	
		M	Zakmans Marks	Cadet Kumite Male -57 kg	
	M	Zalevskis Vitalijs	Cadet Kumite Male -57 kg		
	SD67216	F	Avruskina Jelizaveta	U14 Kumite Female 52+ kg	
F		Cernikova Darina	U14 Kumite Female 52+ kg		
F		Girvica Beata	U21 Kumite Female -61 kg		
F		Jelinska Kinga Magdalena	Cadet Kumite Female -54 kg		
F		Kalēda Undīne	Cadet Kumite Female 61+ kg		
F		Konajeva Jevgenija	Junior Kumite Female -48 kg		
F		Mickevica Estere	U14 Kumite Female -52 kg		
F	Nikonova Arina	U14 Kumite Female -42 kg			



Karate1 Youth League - Venice 2024



ENTRIES BY NATIONAL FEDERATION

As of 8 DEC 2024

Country Code	ID	Gender	Name	Event	Seed
LAT		F	Selavko Olga	Cadet Kumite Female 61+ kg	
		F	Sevcika Vlada	U14 Kumite Female 52+ kg	
		F	Sevcova Sofija	Junior Kumite Female -59 kg	
		F	Spradziņa Arianna	Cadet Kumite Female 61+ kg	
		F	Upeniece Madara	Cadet Kumite Female 61+ kg	
		F	Vasiljeva Alina	Junior Kumite Female -59 kg	
LTU	LTU02310	F	Liutkevičiūtė Miglė	Junior Kumite Female -53 kg	
		F	Petrauskaite Gerda	Junior Kumite Female -48 kg	
LUX	LUX02468	M	AGOSTINO ENZO	Cadet Kumite Male -57 kg	
		M	Almalh Mahmoud	U21 Kumite Male -84 kg	
		M	Arcq Alexander	Junior Kata Male	
	LUX02512	M	Bruscella Samuele Maria	Junior Kata Male	
	LUX02431	M	Chaffort Lucas	U21 Kata Male	
	LUX02187	M	Coimbra Pol	Junior Kumite Male -61 kg	
		M	Davies Alexander	U21 Kumite Male 84+ kg	
		M	Defense Dario	Cadet Kumite Male -57 kg	
	LUX02423	M	FECCHI MATTEO	Cadet Kumite Male -70 kg	
		M	Pierantoni Matteo	Cadet Kumite Male -70 kg	
	LUX02472	M	Serra Rodrigues Tiago	Junior Kumite Male -76 kg	
		M	Szekeres Maxim	Cadet Kumite Male -52 kg	
		M	Todorovic Filip	Cadet Kumite Male -63 kg	
		F	Belabass Zineb	U14 Kumite Female -47 kg	
		F	Breisch Anna	Cadet Kata Female	
		F	Breser Anastasia	Cadet Kata Female	
		F	Costa Nuria	U14 Kata Female	
		F	De Paiva Oceane	U14 Kata Female	
	LUX02432	F	De Rubeis Giulia	Cadet Kumite Female -61 kg	
		F	Durrer Nahima	U14 Kumite Female -52 kg	
		F	El Meskiri Lena	U14 Kumite Female -42 kg	
		F	Gawellek Sarah	Junior Kumite Female -59 kg	
	LUX02426	F	Gomes Solara	U14 Kata Female	
		F	JADIN LANA	U21 Kumite Female -55 kg	
		F	Johanns Camille	Cadet Kata Female	
		F	Moens Alix	Junior Kumite Female -48 kg	
		F	Mostefa-sba Sarah	Cadet Kata Female	
	F	Pierantoni Nora	Cadet Kumite Female 61+ kg		
LUX02275	F	Rodrigo Sarah	Junior Kata Female		
	F	Rosa Maelys	U14 Kumite Female -52 kg		
MLT	MLT002362	M	GRECH JADEN	U14 Kumite Male +55 kg	
	MLT02160	F	ANTONELLI THYIS	Junior Kumite Female -66 kg	
	MLT02238	F	AWAD ATTIA JENNA	Cadet Kata Female	
	MLT02319	F	CONTI ELEONORA	U21 Kata Female	
	MLT02318	F	CONTI JADE	Junior Kata Female	
	MLT2112	F	CUNNINGHAM AMY	U21 Kumite Female -68 kg	
	MLT02317	F	DIMECH DAWN	U14 Kata Female	
	MLT02241	F	ROADLEY-BATTIN EVIE	Junior Kata Female	



Karate1 Youth League - Venice 2024



ENTRIES BY NATIONAL FEDERATION

As of 8 DEC 2024

Country Code	ID	Gender	Name	Event	Seed
MLT	MLT02201	F	SALIBA FRANCESCA	Junior Kata Female	
	MLT2116	F	VELLA JESSICA	U21 Kata Female	
MEX	MEX03231	M	Rodriguez Luis	Cadet Kata Male	
MDA	MDA002526	M	BOGOMAZ MAXIM	U14 Kumite Male -45 kg	
	MDA02267	M	CAPMOALE ALEXANDR	U21 Kumite Male -67 kg	
	MDA002529	M	COLOSIUC PROHOR	U14 Kumite Male +55 kg	
	MDA02453	M	CUCUL SAVELII	Cadet Kumite Male 70+ kg	
	MDA02232	M	DOBROVOLSCHI DENIS	Cadet Kumite Male -63 kg	
	MDA002537	M	FOCSA NICOLAI	Cadet Kumite Male -57 kg	
	MDA002534	M	GANEA BOGDAN	U21 Kumite Male -67 kg	
	MDA02162	M	GRIGORASENCO NICHITA	U21 Kumite Male -75 kg	
	MDA02231	M	GUTU CRISTIAN	U21 Kumite Male -67 kg	
	MDA002536	M	SOROCOLITA VASILII	Cadet Kumite Male -57 kg	
	MDA002532	M	STANU STANISLAV	U14 Kata Male	
	MDA002532	M	STANU STANISLAV	U14 Kumite Male -45 kg	
	MDA02304	M	STAVARACHI RENAT	Cadet Kumite Male -52 kg	
	MDA02414	M	STOIANOV CHIRILL	Cadet Kumite Male -57 kg	
	MDA002531	M	STRATAN MATVEI	Cadet Kumite Male -63 kg	
	MDA002539	M	TAMPEI VLADISLAV	U14 Kumite Male -45 kg	
	MDA002522	M	TERZI DAVID	Junior Kata Male	
	MDA002522	M	TERZI DAVID	Junior Kumite Male -55 kg	
	MDA002535	M	TERZI DEN	Cadet Kumite Male -63 kg	
	MDA02303	M	URSAC PETRU	U14 Kumite Male -40 kg	
	MDA002530	M	VASILIEV ILIA	Cadet Kumite Male -63 kg	
	MDA02382	M	VOLEANSCHI AKIM	U14 Kumite Male -50 kg	
	MDA02379	M	VOLEANSCHI ARSENI	U14 Kumite Male -45 kg	
	MDA002538	M	YAKOVENIUK YAROMYR	U14 Kumite Male -40 kg	
	MDA02342	F	BEREZOVSCAIA ELENA	U21 Kata Female	
	MDA02342	F	BEREZOVSCAIA ELENA	U21 Kumite Female -55 kg	
	MDA002524	F	BIRIUC EVA	U14 Kumite Female 52+ kg	
	MDA002525	F	CERNEI SOFIA	U14 Kumite Female -42 kg	
	MDA002528	F	PUSCA EMILIA	U14 Kata Female	
	MDA02341	F	RADAUTA LOREDANA	Cadet Kumite Female -54 kg	
MDA002527	F	ROIBA MADALINA	U14 Kumite Female -47 kg		
MDA002541	F	RUSNAC ANASTASIA	U14 Kumite Female -52 kg		
MDA02413	F	SERBUL ALEXANDRINA	Junior Kata Female		
MDA002540	F	SIRBU ALEXA	U14 Kumite Female 52+ kg		
MNE		M	ALJOŠEVIĆ ARIJAN	U14 Kumite Male -50 kg	
		M	ALJOŠEVIĆ BENJAMIN	Junior Kata Male	
		M	BJELIĆ DUŠAN	U21 Kumite Male 84+ kg	
	MNE006636	M	Borovic Dusan	U14 Kata Male	
		M	DURUTOVIĆ ĐORĐE	U21 Kumite Male -84 kg	
	MNE2287	M	Jovović Lazar	U21 Kumite Male -84 kg	
		M	Kosović Andrija	Cadet Kumite Male -70 kg	
		M	MILIĆ NIKOLA	U21 Kata Male	
		M	Nikezić Tarik	U14 Kata Male	



Karate1 Youth League - Venice 2024



ENTRIES BY NATIONAL FEDERATION

As of 8 DEC 2024

Country Code	ID	Gender	Name	Event	Seed
MNE		M	Popadić Miloš	U14 Kata Male	
		M	Stevović Uroš	Cadet Kata Male	
		M	ĐONBALJAJ ARDIT	U14 Kumite Male -55 kg	
	MNE004923 9	F	Beljkas Neda	Cadet Kata Female	
		F	Emira Gjonoviq	U14 Kumite Female -52 kg	
		F	Knežević Nađa	U14 Kata Female	
		F	MILIĆ JOVANA	Junior Kata Female	
MAR	MAR02913	M	sadini samir	Junior Kumite Male -61 kg	
NED	NED02694	M	Achghouyab Samy	U21 Kumite Male -67 kg	
	SD49458	M	Blumink Levy	Cadet Kumite Male 70+ kg	
	NED02687	M	Boudewijns Dennis	U21 Kumite Male -75 kg	
	SD81134	M	Castricum Ian	U14 Kumite Male -55 kg	
		M	de Rover Luke	Junior Kumite Male 76+ kg	
		M	El Jattari Mohammed Amine	Junior Kumite Male 76+ kg	
	SD81135	M	Enthoven Scott	U14 Kumite Male -50 kg	
	NED02684	M	Franken Ricardo	U21 Kumite Male -75 kg	
	SD45032	M	Kamel Basem	Junior Kumite Male 76+ kg	
		M	Kouwenhoven Daan	Junior Kumite Male -68 kg	
	NED02676	M	Krijnen Thomas	Junior Kumite Male -68 kg	
	SD60407	M	Lepez Devon	Cadet Kumite Male -57 kg	
		M	Noerkhan Rayan	Cadet Kata Male	
		M	Roubos Sean	U21 Kumite Male -67 kg	
	SD81133	M	Snoodijk Tigo	U14 Kumite Male -55 kg	
	NED3034	M	Stoutjesdijk Aaron	Cadet Kumite Male -52 kg	
	NED2342	M	Teeffelen van Sebastiaan	U21 Kumite Male -75 kg	
	NED02732	M	To Nicolas	Junior Kumite Male -55 kg	
	SD60506	M	Twisk Patrick	Junior Kumite Male -76 kg	
		M	van der Heijden Luca	Junior Kata Male	
	SD44431	M	van der Vliet Merijn	Junior Kumite Male 76+ kg	
	NED02509	M	Van der Weide Niek	U21 Kumite Male -75 kg	
		M	van de Nes Dinand	U14 Kumite Male +55 kg	
	NED02682	M	van Woudenberg Mika	U21 Kumite Male 84+ kg	
	NED02683	M	Werff Kai	U21 Kumite Male -67 kg	
	NED03277	F	Jong de Anniek	Cadet Kumite Female -61 kg	
	NED02396	F	Kakiay Ashley	U21 Kumite Female -61 kg	
	SD81137	F	Keulen van Norah	U14 Kumite Female -52 kg	
		F	Laassal Loubna	Cadet Kata Female	
		F	Lepez Darla	Cadet Kumite Female -47 kg	
	SD81138	F	Leurs Lily	U14 Kumite Female 52+ kg	
		F	Mezraui Dounia Sofia	Junior Kumite Female -48 kg	
	SD81136	F	Pcholko Varvara	U14 Kumite Female -47 kg	
	NED02733	F	Valk Imane	Junior Kumite Female -66 kg	
		F	Van bommel Ise	U14 Kumite Female -52 kg	
	NED03278	F	van Rest Merah	U21 Kata Female	
	SD66426	F	Vlieland Kayleigh	Cadet Kumite Female -54 kg	
	NED02464	F	YALCIN Samina	U21 Kumite Female -50 kg	



Karate1 Youth League - Venice 2024



ENTRIES BY NATIONAL FEDERATION

As of 8 DEC 2024

Country Code	ID	Gender	Name	Event	Seed
NED	NED02697	F	Zwanenburg Robin	Junior Kumite Female 66+ kg	
NCL		M	EVLAKHOFF Kurth	U21 Kumite Male -60 kg	
		F	AMATSOKERMI Kenza	Junior Kumite Female 66+ kg	
MKD		M	Abazi Aldin	Junior Kumite Male -55 kg	
		M	BOZOVIC DANILO	U21 Kumite Male -84 kg	
		M	Elmazi Isa	Cadet Kumite Male -70 kg	
	MKD2637	M	Stojanovikj Stefan	U21 Kumite Male 84+ kg	
		F	Micovska Jovana	U21 Kumite Female -61 kg	
NOR	NOR02484	M	Berg-Alstadsæter Peder Xinge	Junior Kumite Male -61 kg	
	NOR02719	M	Fagerli Demian	Cadet Kumite Male -63 kg	
	NOR02263	M	Hansen Henrik Walstad	U21 Kumite Male -60 kg	
		M	Hansen Martin Walstad	Cadet Kumite Male -57 kg	
	NOR02268	M	Kristensen Petter	U21 Kumite Male -60 kg	
		M	Meltzer Isaac August	Cadet Kata Male	
		M	Pettersen Johannes Mohn	U21 Kumite Male -60 kg	
		M	Syrrist-Gelgota Julius Leander	Junior Kumite Male 76+ kg	
		M	Sælid Mads	U21 Kumite Male -75 kg	
		F	Brenne Linnes Lea	Cadet Kumite Female -61 kg	
		F	Cole Eirin Kristine	Junior Kumite Female -66 kg	
		F	Hansen Celine Marie Walstad	U14 Kumite Female -42 kg	
		F	Johansen Madeleine	Cadet Kumite Female -54 kg	
		F	Martby Linnea	Cadet Kumite Female -54 kg	
		F	Olseng Ingrid	Cadet Kumite Female -47 kg	
PER	SD68686	M	BACHOIR VEGA ANDRE LOUIS	U21 Kumite Male -75 kg	
	PER002830	M	BORJAS SILVA MATHIAS MIGUEL	U14 Kumite Male +55 kg	
		M	Medrano Uribe Flavio Gael	U14 Kumite Male -55 kg	
		M	Sánchez Injante Walter Jesús	Cadet Kumite Male -70 kg	
	SD76802	F	AGUIRRE CAVERO ARANZA LUCIA	U14 Kumite Female -52 kg	
		F	Arias Polanco Ana Belén	U14 Kumite Female 52+ kg	
	PER02703	F	Avila Anticona Johana Althea	U21 Kumite Female -50 kg	
		F	Barrios Inga Damaris Gabriela	Junior Kata Female	
	PER02563	F	Valdivia Monzon Alexandra Sofia	U21 Kata Female	
POL	POL06709	M	BARANOWSKI DOMINIK	U14 Kumite Male -50 kg	
	POL06805	M	BARTNICKI KORNEL	U14 Kumite Male -45 kg	
	POL3495	M	BISEWSKI BARTOSZ	Cadet Kumite Male -63 kg	
	POL3494	M	BISEWSKI JAROSLAW	Cadet Kumite Male -57 kg	
	POL07169	M	BORCHERT IGOR	Cadet Kumite Male -52 kg	
	POL10974	M	BUBNOWSKI KAROL	U14 Kumite Male -55 kg	
	POL2804	M	BUDNY SZYMON	U14 Kumite Male -50 kg	
	POL3562	M	CICHECKI IGOR	Cadet Kumite Male -63 kg	
	POL09385	M	CUPRYJAK DANIEL	U14 Kumite Male -40 kg	
	POL3233	M	CYMANOWSKI JAN	Junior Kumite Male -55 kg	
	POL08785	M	DABEK MACIEJ	U14 Kumite Male +55 kg	
	POL2485	M	Dziuda Dominik	U21 Kumite Male -67 kg	
	POL06140	M	FALKOWSKI PATRYK	U14 Kumite Male -40 kg	
	POL2493	M	Fierek Jan	Junior Kumite Male -68 kg	



Karate1 Youth League - Venice 2024



ENTRIES BY NATIONAL FEDERATION

As of 8 DEC 2024

Country Code	ID	Gender	Name	Event	Seed
POL	POL05436	M	GAJDUS SZYMON	U14 Kumite Male -55 kg	
	POL3246	M	GAJDUS WOJCIECH	Cadet Kumite Male -70 kg	
	POL06564	M	GBUREK WOJCIECH	Cadet Kumite Male -52 kg	
	POL2776	M	GOZDEK STEFAN	U14 Kata Male	
	POL3959	M	GRZESLO IGOR	Cadet Kata Male	
	POL2542	M	Grzybek Hubert	Cadet Kumite Male -63 kg	
	POL2937	M	IWASZKIEWICZ PIOTR	U21 Kata Male	
	POL05899	M	Jibril Makiere	Junior Kumite Male -61 kg	
	POL07212	M	KACZMAREK HUBERT	U14 Kumite Male -45 kg	
		M	Karabon Maksymilian	Cadet Kumite Male -52 kg	
	POL2909	M	KASPRZAK PASCAL	Cadet Kumite Male -63 kg	
	POL2991	M	KIRYLUK PAWEL	U21 Kumite Male 84+ kg	
		M	Kośmider Franciszek	Junior Kumite Male -68 kg	
	POL10793	M	Kołata Borys	U14 Kumite Male +55 kg	
	POL2489	M	Kołodziejczak Przemysław	Junior Kumite Male -76 kg	
	POL06812	M	KRAWIEC KRZYSZTOF	U14 Kumite Male -40 kg	
	POL06606	M	Kwaśniewski Arkadiusz	U21 Kumite Male -60 kg	
	POL10839	M	LEBEDIANSKYI DMITRO	U14 Kata Male	
	POL10839	M	LEBEDIANSKYI DMITRO	U14 Kumite Male -40 kg	
	POL09589	M	Machaj Jakub	U21 Kumite Male -67 kg	
	POL4047	M	MASZOTA FILIP	Junior Kumite Male -61 kg	
	POL3237	M	MAZUROWSKI KACPER	U21 Kumite Male -67 kg	
		M	Małecki Michał	U21 Kata Male	
	POL06329	M	MICKIEWICZ ANTONI	Cadet Kumite Male -70 kg	
	POL3946	M	MIELEWCZYK IGOR	Junior Kumite Male -61 kg	
	POL3414	M	MYDLARZ MICHAL	Cadet Kata Male	
	POL4137	M	NIEDZIELA MICHAL	Cadet Kata Male	
	POL2951	M	NIEDZIELA WOJCIECH	U21 Kata Male	
	POL06191	M	NOWAK MACIEJ	Cadet Kata Male	
	POL2955	M	OLICHWER NATAN	Junior Kumite Male -55 kg	
	POL2956	M	OPAS ALEKSANDER	U21 Kumite Male -60 kg	
	POL10316	M	Ostrowski Mateusz	U14 Kata Male	
	POL10316	M	Ostrowski Mateusz	U14 Kumite Male -45 kg	
	POL07924	M	POLEJOWSKI MIKOLAJ	Junior Kumite Male -76 kg	
	POL3965	M	PRZASNYSKI MICHAL	Cadet Kumite Male 70+ kg	
	POL05661	M	PUDZIANOWSKI MICHAL	U14 Kumite Male -45 kg	
	POL3753	M	ROCHALSKI BRAJAN	U21 Kumite Male -75 kg	
	POL3442	M	Róg Maciej	U21 Kumite Male -75 kg	
	POL2737	M	SARBA KRZYSZTOF	Junior Kumite Male 76+ kg	
	POL06814	M	SCIBISZ ANTONI	U14 Kumite Male -45 kg	
	POL09390	M	SEWASTIANOWICZ JULIAN	Cadet Kumite Male -63 kg	
	POL09154	M	SNIEGOCKI SZYMON	Junior Kata Male	
	POL2543	M	Sojka Fabian	Junior Kumite Male -76 kg	
	POL3299	M	SOLTYS SZYMON	Junior Kumite Male -61 kg	
	POL3363	M	SZCZEGIELNIAK PIOTR	Junior Kumite Male 76+ kg	
	POL2634	M	SZCZEPANSKI SZYMON	Junior Kumite Male -68 kg	
	POL2338	M	SZUBSKI KASPER	Junior Kumite Male -68 kg	
	POL3812	M	Tarkowski Patryk	Junior Kumite Male -68 kg	



Karate1 Youth League - Venice 2024



ENTRIES BY NATIONAL FEDERATION

As of 8 DEC 2024

Country Code	ID	Gender	Name	Event	Seed
POL	POL2728	M	WDOWIARSKI ERYK	Cadet Kata Male	
	POL07992	M	WIECIECH DAWID	Cadet Kumite Male -52 kg	
	POL3064	M	WITTEK PATRYK	Junior Kata Male	
	POL05610	M	WOJARSKI WIKTOR	Junior Kumite Male -76 kg	
	POL2694	M	WOJCIECHOWSKI KACPER	Junior Kumite Male -55 kg	
	POL3943	M	WOJCIECHOWSKI KONRAD	Junior Kumite Male -61 kg	
	POL3106	M	WOZNIAK KAJETAN	Junior Kumite Male -76 kg	
	POL3362	M	ZAGOZDZAN IGOR	U21 Kumite Male -67 kg	
	POL06139	M	ZALESKI ANTONI	U14 Kumite Male -45 kg	
	POL3560	M	ZYGANOWSKI JAKUB	Cadet Kumite Male -52 kg	
		F	Bachorz Lori	Cadet Kata Female	
	POL3964	F	BALUT NATALIA	Junior Kumite Female -66 kg	
	POL05545	F	BALUT PATRYCJA	U14 Kumite Female -47 kg	
	POL08643	F	BIELSKA PAULINA	Cadet Kumite Female -61 kg	
		F	Brzostowska Julia	U21 Kumite Female -50 kg	
	POL3146	F	CHLEBOWSKA ANNA	Junior Kumite Female -53 kg	
	POL2900	F	CHLEWICKA NATALIA	Junior Kumite Female -66 kg	
	POL3284	F	CICHOSZEWSKA NATASZA	U21 Kumite Female -68 kg	
	POL07767	F	Criou Eva	U21 Kumite Female -61 kg	
	POL3271	F	Dmytruszyńska Monika	U21 Kata Female	
	POL08641	F	DOMIAN MAJA	Cadet Kumite Female -61 kg	
	POL2877	F	Dopieralska Zuzanna	Junior Kumite Female -59 kg	
	POL08881	F	DRONCHANKA KSENIYA	U21 Kumite Female -55 kg	
	POL11248	F	Fertsch Natalia	Cadet Kumite Female 61+ kg	
	POL04919	F	Jedrzejewski Amelia	Junior Kumite Female 66+ kg	
	POL4091	F	KALLAS KAJA	U14 Kata Female	
	POL4091	F	KALLAS KAJA	U14 Kumite Female -42 kg	
	POL11963	F	Kapica Zuzanna	Cadet Kumite Female -61 kg	
	POL09532	F	KASZYNSKA ALICJA	Cadet Kata Female	
	POL09532	F	KASZYNSKA ALICJA	Cadet Kumite Female -54 kg	
	POL3411	F	KAWICKA DOMINIKA	U21 Kumite Female -61 kg	
	POL3409	F	KAWICKA WERONIKA	U21 Kumite Female -55 kg	
	POL06845	F	KNYZIAK ZOFIA	Cadet Kata Female	
	POL05855	F	KOT ALEKSANDRA	U21 Kumite Female -61 kg	
	POL3867	F	KRACZAJ WIKTORIA	Cadet Kumite Female -61 kg	
	POL2901	F	KULAWIK ZUZANNA	Junior Kumite Female -53 kg	
	POL06896	F	Lewandowska Katarzyna	U21 Kumite Female -61 kg	
	POL3068	F	MASLANKA JULIA	Junior Kumite Female -66 kg	
	POL3244	F	MELLER ADRIANNA	Cadet Kumite Female -47 kg	
	POL3257	F	NOWAK WIKTORIA	Junior Kata Female	
		F	Olszańska Wiktorja	Junior Kumite Female -53 kg	
	POL10439	F	ONISHCHENKO ALISA	U14 Kata Female	
	POL2910	F	PRZYBYLEK JULIA	Cadet Kumite Female -61 kg	
	POL07927	F	SARBA MALGORZATA	U14 Kumite Female 52+ kg	
	POL10818	F	SAWICKA ADELA	Junior Kumite Female -48 kg	
	POL3210	F	Smoczyńska Amelia	Cadet Kumite Female -54 kg	
	POL3975	F	SZYMANSKA WIKTORIA	Junior Kumite Female 66+ kg	
	POL2566	F	Toś Aleksandra	Cadet Kata Female	



Karate1 Youth League - Venice 2024



ENTRIES BY NATIONAL FEDERATION

As of 8 DEC 2024

Country Code	ID	Gender	Name	Event	Seed
POL	POL2567	F	Toś Wiktoria	U21 Kata Female	
	POL12674	F	WALCZAK KLAUDIA	Junior Kumite Female -66 kg	
	POL3143	F	WASILEWSKA ZUZANNA	Junior Kumite Female -48 kg	
	POL06216	F	WIECZORKIEWICZ WIKTORIA	U21 Kata Female	
	POL3033	F	WOJDA LENA	Junior Kata Female	
	POL2854	F	WYSOCKA EMILIA	Junior Kata Female	
	POL07916	F	ZARSKA JULIA	Junior Kumite Female -66 kg	
	POL2636	F	Żurawska Antonina	U21 Kumite Female -61 kg	
	POL2858	F	ZUREK MILENA	Cadet Kata Female	
POR		M	Abreu Tiago	Junior Kumite Male -76 kg	
		M	Aguiar André	Cadet Kumite Male 70+ kg	
		M	Aguiar Gustavo	Cadet Kumite Male -63 kg	
		M	Almeida Tomás Duarte de	Junior Kumite Male -76 kg	
		M	ALVES DIOGO GABRIEL	Junior Kumite Male 76+ kg	
	POR2294	M	Alves Rafael	U21 Kumite Male -67 kg	
		M	Barbosa Diogo	Junior Kumite Male -68 kg	
		M	Barbosa Rodrigo	Junior Kata Male	
		M	Bernardes Duarte	Cadet Kumite Male -63 kg	
		M	Borges Troy	Cadet Kata Male	
		M	Borges Troy	Cadet Kumite Male -70 kg	
		M	Cardoso Manuel	Cadet Kumite Male -57 kg	
		M	Carvalho Jaime	Junior Kumite Male -76 kg	
		M	Casal Daniel	U21 Kumite Male -67 kg	
		M	Cidra Diogo	Junior Kumite Male -61 kg	
	POR02804	M	Costa Afonso Lencart	Junior Kumite Male -61 kg	
		M	Costa João Lencart	Cadet Kumite Male -52 kg	
		M	Costa Pedro	Cadet Kumite Male -70 kg	
		M	Costa Pedro Lencart	Cadet Kumite Male -52 kg	
		M	Cristina David	Junior Kumite Male -68 kg	
		M	Durão Francisco	U14 Kata Male	
		M	Emídio Abel	Cadet Kumite Male 70+ kg	
	POR02396	M	FERNANDES BERNARDO PINEU LOPES	U21 Kumite Male -75 kg	
		M	Fernandes Santiago Pinéu	Junior Kumite Male -55 kg	
		M	Ferreira Afonso	Cadet Kumite Male -52 kg	
		M	Ferreira Guilherme	Junior Kumite Male -55 kg	
		M	Figueiras Diogo	U14 Kumite Male -55 kg	
		M	Franco Tomás	Cadet Kumite Male -52 kg	
		M	Garcia António Gonçalo	U14 Kumite Male -50 kg	
		M	Gaspar Rodrigo	Cadet Kata Male	
	POR02720	M	GONCALVES GUILHERME	U21 Kumite Male -67 kg	
		M	Gonçalves João	Junior Kumite Male -61 kg	
	POR02479	M	Inacio Diogo	U21 Kumite Male -75 kg	
		M	Laranjeira Frederico	Cadet Kumite Male -57 kg	
		M	Marçal João	Junior Kumite Male 76+ kg	
		M	Martins Henrique	U21 Kumite Male -75 kg	
		M	Martins João	U21 Kumite Male -60 kg	
	SD59627	M	Mateus Vasco	Cadet Kata Male	



Karate1 Youth League - Venice 2024



ENTRIES BY NATIONAL FEDERATION

As of 8 DEC 2024

Country Code	ID	Gender	Name	Event	Seed
POR	POR02759	M	Mendinhos António	Junior Kumite Male -61 kg	
		M	Moreira David	Junior Kata Male	
	POR03188	M	Moreira Jerónimo Valentim Pedro	Cadet Kumite Male -70 kg	
	POR02948	M	Morgado Tomás	Junior Kata Male	
		M	Moura Luís David	U21 Kumite Male -75 kg	
		M	Neto Francisco Silva	U21 Kumite Male -75 kg	
		M	Oliveira Diogo	U14 Kumite Male -50 kg	
	POR02709	M	OLIVEIRA GUSTAVO	U21 Kumite Male -60 kg	
		M	Oliveira Martim	Junior Kata Male	
		M	Oliveira Rodrigo	U14 Kata Male	
		M	Oliveira Tomás	Cadet Kumite Male -63 kg	
		M	Palma Martim	Cadet Kumite Male -52 kg	
	POR003307	M	PENA ANDRE	Cadet Kumite Male -57 kg	
		M	Pereira Afonso	Junior Kumite Male -68 kg	
		M	Pereira João	Junior Kumite Male -76 kg	
		M	Pinto André	U14 Kumite Male -55 kg	
	POR02702	M	Proença Ruben	U21 Kata Male	
		M	Rebelo Tiago	U14 Kumite Male -40 kg	
		M	Ribeiro Diogo	U21 Kumite Male -67 kg	
		M	Ribeiro Francisco	U21 Kumite Male -75 kg	
		M	Rocha Gonçalo	U14 Kata Male	
		M	Rodrigues Rafael	Cadet Kumite Male -70 kg	
		M	Santos André	Cadet Kata Male	
	POR02703	M	Santos Diogo	Junior Kata Male	
		M	Santos Gabriel	Cadet Kumite Male -52 kg	
		M	Saraiva Martim	U14 Kumite Male -45 kg	
	SD65457	M	Seco João	U21 Kumite Male -84 kg	
	POR02465	M	Tojeira Diogo	U21 Kumite Male -67 kg	
		M	Tomé Francisco	Junior Kumite Male -68 kg	
		M	Veiga Tiago	Junior Kumite Male -68 kg	
	POR02704	M	Vieira João	Junior Kata Male	
		M	Vilela Francisco	Junior Kata Male	
		F	Asturiano Maria	U21 Kumite Female 68+ kg	
	POR03183	F	BAZYUK VICTORIA	Cadet Kata Female	
	POR03183	F	BAZYUK VICTORIA	Cadet Kumite Female -61 kg	
		F	Brandauer Chiara	Cadet Kata Female	
		F	Cadete Beatriz	Junior Kumite Female -66 kg	
		F	Cardoso Carolina	U14 Kata Female	
		F	Cardoso Carolina	U14 Kumite Female -42 kg	
	POR02715	F	Cardoso Maria	U21 Kata Female	
		F	Castro Beatriz	Cadet Kumite Female -61 kg	
		F	Coelho Leonor	U14 Kumite Female -47 kg	
		F	Costa Teresa	U14 Kumite Female -52 kg	
		F	Cunha Sara	U14 Kata Female	
	POR02764	F	Eça Guimarães Marta Pimenta	Junior Kumite Female -53 kg	
	POR03181	F	FERNANDES EMA	Cadet Kumite Female -47 kg	
		F	Fernandes Mariana	Cadet Kumite Female -61 kg	
		F	Ferreira Anamar	Junior Kata Female	



Karate1 Youth League - Venice 2024



ENTRIES BY NATIONAL FEDERATION

As of 8 DEC 2024

Country Code	ID	Gender	Name	Event	Seed
POR	SD60047	F	Franco Isabel	Junior Kumite Female -53 kg	
		F	Gaspar Maria Isabel	Cadet Kumite Female -47 kg	
POR	POR03182	F	Gonçalves Diana Filipa	U14 Kumite Female -47 kg	
		F	GONCALVES LEONOR	Cadet Kumite Female -54 kg	
		F	Guiomar Salomé	Cadet Kata Female	
		F	Jacinto Madalena	Junior Kata Female	
		F	LADEIRO MATILDE	U14 Kumite Female -47 kg	
		F	Lopes Joana	U21 Kumite Female -61 kg	
		F	Lourenço Alice	U14 Kumite Female -47 kg	
		F	Lourenço Daniela	U21 Kumite Female -61 kg	
POR	POR02714	F	Lourenço Daniela	U21 Kumite Female -61 kg	
POR	POR02873	F	Marques Rita	Junior Kata Female	
		F	Martins Joana	Cadet Kata Female	
POR	POR02712	F	Martins Júlia	Junior Kata Female	
		F	Martins Rita	U21 Kata Female	
SD	SD59628	F	Matos Isis	Cadet Kumite Female -47 kg	
		F	Meco Alice	Cadet Kata Female	
		F	Morais Oliveira Inês	Junior Kumite Female -59 kg	
		F	MOURA LEONOR	Cadet Kumite Female -54 kg	
		F	OLIVEIRA INÊS	Junior Kata Female	
		F	OLiveira Sara	Cadet Kumite Female -61 kg	
		F	Pereira Maria Leonor	Cadet Kata Female	
		F	PINHEIRO SOFIA	Cadet Kumite Female -54 kg	
POR	POR003308	F	Pinto Isabela	Junior Kata Female	
		F	Pinto Matilde	U14 Kumite Female 52+ kg	
		F	Pinto Verónica	U21 Kumite Female -68 kg	
POR	POR02716	F	Ribeiro Barbara	U21 Kata Female	
POR	POR02761	F	Rodrigues Angelina	Junior Kumite Female 66+ kg	
		F	Santos Carolina	Junior Kumite Female -59 kg	
POR	POR02713	F	Santos Diana	Junior Kumite Female -48 kg	
		F	Santos Joana	Junior Kata Female	
		F	Santos Madalena	Cadet Kumite Female 61+ kg	
		F	Santos Rita	U21 Kata Female	
		F	Silva Maria	Junior Kumite Female -53 kg	
		F	TEIXEIRA ANA BEATRIZ	Junior Kumite Female -59 kg	
		F	Teixeira Lara	U21 Kata Female	
		F	Varanda Gabriela	Cadet Kumite Female -54 kg	
KOR	KOR002397	M	HA TAESEOK	Junior Kumite Male -61 kg	
	KOR002399	M	KIM MINJAE	Junior Kata Male	
	KOR02351	F	CHOI HAEUN	Junior Kata Female	
	KOR02353	F	KWUN HYEWON	Junior Kumite Female 66+ kg	
ROU	ROU003969	M	ALEXANDRU GABRIEL TRASCA	Junior Kumite Male -76 kg	
	ROU03240	M	ALIXANDROIU SEBASTIAN	U14 Kumite Male -45 kg	
	ROU003971	M	ANDREI ANGIU	Cadet Kumite Male 70+ kg	
	ROU003955	M	ANDREI CONSTANTIN	Junior Kumite Male -76 kg	
	ROU03703	M	ANDREI EDUARD MIHAI	U14 Kumite Male -40 kg	
	ROU03230	M	BAHNARU DAVID	U14 Kumite Male -45 kg	
	ROU03801	M	BARCIU IONUT VALENTIN	Junior Kumite Male 76+ kg	



Karate1 Youth League - Venice 2024



ENTRIES BY NATIONAL FEDERATION

As of 8 DEC 2024

Country Code	ID	Gender	Name	Event	Seed
ROU	ROU03743	M	BOGZA GABRIEL	Junior Kumite Male -68 kg	
	ROU02985	M	BUDAN PIRVU PATRICK ALEX	Junior Kumite Male -76 kg	
	ROU03613	M	BUICA MATEI	U14 Kumite Male -55 kg	
	ROU03624	M	BURLACU DRAGOS	U14 Kumite Male -40 kg	
	ROU03588	M	BURNAZ DANIEL	Cadet Kumite Male -57 kg	
	ROU2480	M	COMANESCU PETRU	U21 Kata Male	
	ROU2475	M	COSTACHE LUIS ANDREI	U21 Kumite Male -84 kg	
	ROU003966	M	CRISTIAN IONESCU	Cadet Kumite Male -63 kg	
	ROU003983	M	DARIUS IONECI	U14 Kata Male	
	ROU03715	M	DOLOMAN MIHAI CRISTIAN	Cadet Kumite Male -70 kg	
	ROU03605	M	DUMITRU MIRCEA ANDREI	U14 Kumite Male -50 kg	
	ROU02704	M	DUMITRU ROBERT	Cadet Kumite Male -63 kg	
	ROU003863	M	EDUARD MARIAN RADU	U14 Kumite Male +55 kg	
	ROU003965	M	ERIK CHRISTIAN ANDREI	Junior Kumite Male -55 kg	
	ROU003967	M	GABRIEL BOTEA	Cadet Kumite Male -70 kg	
	ROU02716	M	GEORGESCU THEODOR PETRU	Junior Kumite Male 76+ kg	
	ROU03330	M	GHERASE DAVID GEORGE	Junior Kumite Male -68 kg	
	ROU02984	M	GLODEANU MARC	Junior Kumite Male -76 kg	
	ROU2371	M	GRIGORIU STEFAN ANTON	U21 Kumite Male -67 kg	
	ROU03589	M	GUTA PATRIK	Junior Kumite Male -61 kg	
	ROU02831	M	IANCU DAVID ADRIAN	Junior Kumite Male -61 kg	
	ROU03242	M	IGARELU VICTOR	Cadet Kumite Male 70+ kg	
	ROU03370	M	IHNATIUC OCTAVIAN RAZVAN	Junior Kumite Male 76+ kg	
	ROU2291	M	IONASCU EDUARD	Junior Kumite Male 76+ kg	
	ROU03592	M	IONASCU SEBASTIAN	Cadet Kumite Male -52 kg	
	ROU03593	M	ISCIUC MATEO EDWARD	Cadet Kata Male	
	ROU03108	M	LAPUSCA IONUT-ADRIAN	Junior Kumite Male -76 kg	
	ROU2292	M	LUNGU LUCIAN	Junior Kumite Male -61 kg	
	ROU03586	M	LUTA ANDREI	Cadet Kumite Male -70 kg	
	ROU03600	M	MARIA CEZAR	U14 Kata Male	
	ROU003972	M	MIHAI DRAGOS SARU	Cadet Kumite Male -70 kg	
	ROU2446	M	NEAGU-BARZAN ALEXANDRE	Junior Kumite Male -61 kg	
	ROU03620	M	OSTAFIE MANDRES CRISTIAN ANDREI	U14 Kumite Male +55 kg	
	ROU03751	M	PAVEL MIHAI IULIAN	Junior Kumite Male -68 kg	
	ROU003978	M	PETRU STAICU CALINESCU	U14 Kata Male	
	ROU003978	M	PETRU STAICU CALINESCU	U14 Kumite Male -40 kg	
	ROU03372	M	POPESCU MATHIAS	Junior Kumite Male -76 kg	
	ROU03594	M	PRITA ARIS LUCA	Junior Kumite Male 76+ kg	
	ROU02698	M	RADULESCU STEFAN	U21 Kumite Male -84 kg	
	ROU003977	M	RADU ANDREI RUSU	U14 Kata Male	
	ROU003977	M	RADU ANDREI RUSU	U14 Kumite Male -40 kg	
	ROU003968	M	RADU STEFAN SERBAN	Junior Kumite Male 76+ kg	
	ROU003960	M	RAIS CONSTANTIN	Cadet Kumite Male -70 kg	
	ROU2438	M	RAZVAN GEORGE FLOREA	Cadet Kata Male	
	ROU003954	M	ROBERT ADRIAN GOZI	Junior Kumite Male 76+ kg	
	ROU03757	M	ROSESCU VLAD	Cadet Kumite Male 70+ kg	
	ROU03744	M	SALOMIA DRAGOS IONUT	Junior Kumite Male 76+ kg	



Karate1 Youth League - Venice 2024



ENTRIES BY NATIONAL FEDERATION

As of 8 DEC 2024

Country Code	ID	Gender	Name	Event	Seed
ROU	ROU03765	M	TANASE ANDREI	Junior Kumite Male -55 kg	
	ROU2183	M	TORNACI ERHAN	U21 Kumite Male -60 kg	
	ROU03722	M	TUDOR LEONARD	Cadet Kumite Male 70+ kg	
	ROU03630	M	TUDORACHE STEFAN ALEXANDRU	U14 Kumite Male -50 kg	
	ROU03606	M	VAIA SEBASTIAN NICOLAE	Cadet Kumite Male -52 kg	
	ROU03089	M	VASILE DAVID GABRIEL	U21 Kumite Male 84+ kg	
	ROU003849	F	ALEXIA TANASESCU	Junior Kata Female	
	ROU003868	F	ALEXIA VACAREAN	U14 Kata Female	
	ROU03727	F	ANCUTA DOMINIQUE MARIA	U14 Kumite Female 52+ kg	
	ROU03098	F	ANDREI LORELLEY ANISIA	U21 Kumite Female -55 kg	
	ROU03337	F	ANGHEL BIANCA	Junior Kumite Female 66+ kg	
	ROU003976	F	ANTONIA COZMA	Junior Kumite Female -53 kg	
	ROU03577	F	ASABI TIMEEA GAGEA	Cadet Kata Female	
	ROU03737	F	BAICU LORENA	Junior Kumite Female -48 kg	
	ROU03229	F	BALANESCU IOANA	Cadet Kumite Female -54 kg	
	ROU03228	F	BALANESCU MARIA	Cadet Kumite Female -47 kg	
	ROU02981	F	BANEASU MICHELLE	U21 Kata Female	
	ROU03706	F	BIANCA MUNTEANU	Junior Kumite Female -59 kg	
	ROU03629	F	BOLINTIRU DARIA	U14 Kumite Female -47 kg	
	ROU03735	F	BUTURA ANDREEA	Junior Kumite Female -53 kg	
	ROU03614	F	CHIRIAC ANDREEA	U14 Kumite Female -47 kg	
	ROU2185	F	COMAN MARIA CRISTINA	U21 Kumite Female 68+ kg	
	ROU03726	F	CONSTANTIN DARIA MIHAELA	Cadet Kumite Female -47 kg	
	ROU03759	F	CURCA MARIA	Cadet Kumite Female -61 kg	
	ROU03708	F	DRAGAN DIANA	Junior Kumite Female 66+ kg	
	ROU03729	F	DUMITRASCU COSMINA	Cadet Kata Female	
	ROU003970	F	ELENA DIANA GHEORGHE	Cadet Kata Female	
	ROU003859	F	ESTERA APOSTOLACHE	U14 Kumite Female -47 kg	
	ROU03599	F	GRIGORIU ARINA IOANA	U14 Kata Female	
		F	HOANG MINH CHAU	Cadet Kumite Female -54 kg	
	ROU003981	F	ILINKA DUMITRU	U14 Kata Female	
	ROU003982	F	INNA DUMITRU	U14 Kata Female	
	ROU003979	F	IRINA ALEXANDRA NUTU	Junior Kumite Female -53 kg	
	ROU03095	F	IVASCU LARISA ADRIANA	U21 Kumite Female -61 kg	
	ROU003860	F	LARISA GHITA	U14 Kumite Female -42 kg	
	ROU003853	F	LORENA GABRIELA POROF	U14 Kumite Female -52 kg	
	ROU03734	F	MACOVEI DIANA	Cadet Kumite Female 61+ kg	
	ROU2367	F	MANICA ANTONIA	U21 Kumite Female -61 kg	
	ROU2461	F	MANICA BRIANA	U21 Kumite Female -68 kg	
	ROU003957	F	MARA IONESCU	Cadet Kumite Female -61 kg	
	ROU2448	F	MARIA SIMION	Cadet Kata Female	
	ROU03596	F	MICLEA NATALIA	Cadet Kumite Female -61 kg	
	ROU03587	F	MIHALEA FLAVIA	Cadet Kumite Female 61+ kg	
	ROU2569	F	NASTAS PATRICIA	U21 Kumite Female -50 kg	
	ROU003980	F	NATALIA CIUTACU	U14 Kumite Female -42 kg	
	ROU003854	F	OANA ELENA VLAD	Junior Kumite Female -53 kg	
	ROU03728	F	OANCEA MELANIA	Cadet Kata Female	
	ROU003850	F	PATRICIA ADRIANA MURESAN	U14 Kumite Female -52 kg	



Karate1 Youth League - Venice 2024



ENTRIES BY NATIONAL FEDERATION

As of 8 DEC 2024

Country Code	ID	Gender	Name	Event	Seed
ROU	ROU03597	F	POPESCU BIANCA	U14 Kumite Female -52 kg	
	ROU03595	F	PRITA IANA IRINA	U14 Kumite Female 52+ kg	
	ROU003837	F	RAISA ENACHE	Cadet Kumite Female -61 kg	
	ROU003975	F	SARA NASTAS	U14 Kumite Female -42 kg	
	ROU003869	F	SARA STANCIU	U14 Kata Female	
	ROU003956	F	SOFIA GHINIA	Junior Kumite Female -53 kg	
	ROU03747	F	STEFAN SOFIA NICOLA	Cadet Kumite Female -61 kg	
	ROU2191	F	STOIAN ALEXANDRA MIHAELA	U21 Kumite Female -55 kg	
	ROU02712	F	STOROBANEANU EMILIA	U21 Kumite Female -55 kg	
	ROU02702	F	SULU KARINA MIHAELA	Cadet Kumite Female -54 kg	
	ROU03604	F	TERPEZAN MARIA	Cadet Kumite Female -47 kg	
		F	Topala Maria Ximena	Junior Kumite Female -53 kg	
	ROU03227	F	URIAN RALUCA	U14 Kumite Female -42 kg	
	ROU03745	F	VOICU AMALIA IOANA	Cadet Kumite Female -61 kg	
SCO		M	Cameron Bruce	Cadet Kumite Male -57 kg	
		M	Craib James	Cadet Kumite Male -52 kg	
		M	Estrada Tomas	Cadet Kumite Male -63 kg	
		M	France Kyle	Cadet Kata Male	
	SCO02405	M	Furness Cameron	U21 Kumite Male -84 kg	
		M	Guetarri Samir	Cadet Kumite Male -57 kg	
	SCO02194	M	Hamill Adam	U21 Kumite Male -60 kg	
	SCO02200	M	Packwood Benjamin	Junior Kumite Male -68 kg	
		M	Reynolds Sonny	Junior Kumite Male -55 kg	
		M	Salehi Shakar	U21 Kata Male	
		M	Wood Lewis	U14 Kumite Male -45 kg	
		F	Bauld Elize	Junior Kumite Female -66 kg	
		F	Cooney Grace	Junior Kumite Female -53 kg	
		F	Duff Julia	Cadet Kumite Female -61 kg	
SCO02409	F	Ewing Maia	Cadet Kumite Female 61+ kg		
SCO2155	F	Ewing Neve	U21 Kumite Female 68+ kg		
SEN	SEN002724	M	TOURE MOUHAMADOU BACHIR	Cadet Kumite Male 70+ kg	
	SEN02468	F	DE HAAN FAMA SAMASSA	Junior Kumite Female -66 kg	
SRB		M	Andonov Nikola	Cadet Kumite Male 70+ kg	
		M	Aničić Luka	Junior Kumite Male -55 kg	
		M	Banjalučkić Veljko	Cadet Kata Male	
	SRB2536	M	Boškov Aleksandar	U21 Kata Male	
		M	Djurdjić Marko	Junior Kumite Male -55 kg	
		M	Greb Andrija	U14 Kata Male	
		M	Horvat Todor	Cadet Kumite Male -52 kg	
	SD70852	M	Jakovljevic Vasilije	Junior Kata Male	
		M	Jevremovic Svetislav	U14 Kata Male	
		M	Jevremovic Svetislav	U14 Kumite Male +55 kg	
	M	Jovanovic Ognjen	U14 Kumite Male +55 kg		
	M	Jovanović Vukašin	Cadet Kumite Male -52 kg		
	M	Kosanovic Mateja	U14 Kumite Male -55 kg		
	M	Krstin Filip	Cadet Kumite Male -57 kg		



Karate1 Youth League - Venice 2024



ENTRIES BY NATIONAL FEDERATION

As of 8 DEC 2024

Country Code	ID	Gender	Name	Event	Seed
SRB		M	Laušević Danilo	U14 Kumite Male -50 kg	
		M	Lazic Ilija	U14 Kumite Male -55 kg	
		M	Milić Todor	U14 Kumite Male -55 kg	
		M	Milošević Ilija	Junior Kumite Male 76+ kg	
		M	Milunovic Stefan	Junior Kumite Male 76+ kg	
		M	Petrović Petar	U14 Kumite Male -45 kg	
SRB03733		M	POPOVIC JOVAN	U14 Kumite Male -55 kg	
		M	Stepanovic El Samer Luka	Junior Kumite Male 76+ kg	
		M	Stojanovic Ognjen	Junior Kumite Male -76 kg	
		M	Stojković Petar	U14 Kumite Male -45 kg	
		M	Tasić Nikola	U14 Kumite Male -50 kg	
		M	Toković Mihailo	Cadet Kumite Male -70 kg	
		M	Urošević Jovan	Cadet Kata Male	
		M	Vasiljević Strahinja	U14 Kumite Male +55 kg	
		M	Vučković Aleksandar	Junior Kumite Male -61 kg	
		M	Vujičić Jug	U14 Kumite Male +55 kg	
		M	Vukasinovic Marko	Junior Kumite Male -61 kg	
		M	Zivkovic Ilija	U14 Kumite Male +55 kg	
		M	Đokić Filip	U21 Kumite Male -75 kg	
		F	Četnik Sofija	U14 Kumite Female -42 kg	
		F	Coso Anja	U21 Kumite Female -50 kg	
		F	Djeric Maja	U14 Kumite Female 52+ kg	
		F	Djoković Mila	U14 Kata Female	
		F	Djordjevic Andjela	Junior Kumite Female -48 kg	
		F	Grozdanic Ana	Junior Kumite Female -66 kg	
		F	Grujanić Irena	U14 Kata Female	
		F	Grujić Milica	U14 Kumite Female -52 kg	
		F	Grujic Sofija	U14 Kumite Female 52+ kg	
		F	Ivanovic Andrea	U14 Kata Female	
		F	Jakić Andrea	U14 Kumite Female -42 kg	
		F	Jakić Nina	U14 Kumite Female -42 kg	
		F	Jovanovic Nina	U14 Kumite Female -52 kg	
		F	Jovičić Anja	U14 Kumite Female 52+ kg	
		F	Kecap Hana	Cadet Kumite Female -54 kg	
		F	Kolarevic Iva	Cadet Kumite Female 61+ kg	
		F	Kopčok Mila	U14 Kata Female	
		F	Krstin Elena	U14 Kumite Female -42 kg	
		F	Laušević Daša	Cadet Kata Female	
		F	Lazovic Minja	U14 Kumite Female -52 kg	
		F	Ljukovčanin Nađa	Cadet Kata Female	
		F	Macura Nina	U14 Kumite Female 52+ kg	
		F	Maksović Jovana	U14 Kumite Female -52 kg	
		F	Malbašić Helena	Cadet Kata Female	
		F	Martac Sofija	U14 Kumite Female -42 kg	
		F	Miladinović Kalina	U14 Kata Female	
		F	Miranovic Lara	Cadet Kumite Female 61+ kg	
SRB03019		F	Miranovic Masa	Junior Kumite Female -48 kg	
		F	Mirosavić Lena	U14 Kumite Female 52+ kg	



Karate1 Youth League - Venice 2024



ENTRIES BY NATIONAL FEDERATION

As of 8 DEC 2024

Country Code	ID	Gender	Name	Event	Seed	
SRB		F	Muric Miona	Cadet Kata Female		
		F	Nikić Jana	Cadet Kata Female		
	SRB03266		F	Nikolic Mina	U21 Kata Female	
			F	Perović Anđela	Cadet Kata Female	
			F	Petrović Ružica	U14 Kumite Female -42 kg	
			F	Popovic Jana	Junior Kumite Female -66 kg	
			F	Popovic Sara	Cadet Kumite Female 61+ kg	
			F	Rauković Anđela	Junior Kumite Female -66 kg	
			F	Rudinac Anastasija	U14 Kumite Female -47 kg	
			F	Šibinac Dunja	U14 Kata Female	
			F	Sinobad Petra	Cadet Kumite Female -47 kg	
			F	Starčević Sara	Junior Kata Female	
			F	Subotić Milica	U14 Kumite Female -47 kg	
			F	Todorovic Iva	Cadet Kumite Female 61+ kg	
			F	Ugarak Andjelija	Cadet Kumite Female 61+ kg	
			F	Valašek Nađa	U14 Kata Female	
			F	Vincic Jana	Cadet Kumite Female -54 kg	
			F	Vulovic Marija	Cadet Kumite Female 61+ kg	
			F	Vulovic Teodora	Cadet Kumite Female -54 kg	
			F	Zvezdanovic Andjela	Junior Kumite Female -53 kg	
SVK		M	BABEL Branislav	U14 Kata Male		
	SVK02638	M	Bohunický Lukáš	Junior Kumite Male 76+ kg		
		M	Buda Michal	U14 Kumite Male -55 kg		
		M	Bugan Leo	U14 Kata Male		
		M	Černo Tomas	U14 Kumite Male -45 kg		
		M	Chrenko Jan	Junior Kumite Male -61 kg		
	SVK02343	M	Chrenko Samuel	Cadet Kumite Male -63 kg		
		M	Čiaky Martin	U21 Kumite Male -75 kg		
		M	Cimerman Samuel	U14 Kumite Male +55 kg		
		M	Cséfalvay Pavol	Junior Kumite Male -55 kg		
		M	Cséfalvay Peter	Junior Kumite Male -55 kg		
		M	Dado Alex	Cadet Kumite Male -63 kg		
		M	Dolnický Adam	U21 Kumite Male -60 kg		
		M	Doncs Eugen	Cadet Kumite Male -57 kg		
		M	Elias Matus	Cadet Kata Male		
		M	Figa Martin	U14 Kumite Male -45 kg		
	SVK02799	M	Filip Denis	U21 Kata Male		
		M	Foltin Milan	Cadet Kumite Male -70 kg		
	SD77100	M	Géci Boris	Cadet Kumite Male -63 kg		
	SVK02796	M	GENDES David	Cadet Kata Male		
M		Gendes Juraj	U14 Kata Male			
SVK02797	M	Gočík Tomáš Daniel	Junior Kumite Male 76+ kg			
	M	Gyulaffy Peter	Junior Kata Male			
	M	Hnyk Ronald	Junior Kumite Male 76+ kg			
SVK2301	M	Holub Jan Peter	U14 Kumite Male -45 kg			
	M	Hudec Adam	Junior Kata Male			
	M	Kešefák Dominik	U21 Kumite Male 84+ kg			



Karate1 Youth League - Venice 2024



ENTRIES BY NATIONAL FEDERATION

As of 8 DEC 2024

Country Code	ID	Gender	Name	Event	Seed
SVK	SVK2210	M	Kodaj Simon	U21 Kata Male	
		M	Kompauer Maxim	Cadet Kumite Male -52 kg	
		M	Kotek Dominik	Cadet Kumite Male -57 kg	
	SVK02623	M	Kováč Simon	U21 Kumite Male -67 kg	
		M	KOVÁČIK Šimon	U14 Kumite Male -50 kg	
		M	Koval David	Cadet Kumite Male -52 kg	
		M	Krajčík Filip	Cadet Kumite Male 70+ kg	
		M	Kubanka Dominik	U14 Kumite Male -55 kg	
		M	Kutlák Kamil	U14 Kumite Male -55 kg	
		M	Kvasnica Martin	Cadet Kumite Male -70 kg	
	SD77113	M	Kysucký Lukáš	Cadet Kumite Male -63 kg	
		M	Lehocký Adam	Cadet Kumite Male -57 kg	
		M	Leštinský Michal	U14 Kumite Male +55 kg	
		M	Lopatka Martin	U14 Kumite Male +55 kg	
		M	Macko Peter	Cadet Kata Male	
		M	Maňúr Jakub	U14 Kumite Male -40 kg	
		M	Marcinek Maxim	U14 Kumite Male -50 kg	
		M	Meňhert Michal	U14 Kumite Male -50 kg	
	SVK02689	M	Miklovics Damian	U21 Kata Male	
		M	Mitrik Richard	Cadet Kumite Male 70+ kg	
		M	Mrlían Adam Ján	U14 Kumite Male -55 kg	
		M	Muller Juraj	Junior Kata Male	
		M	Naňo Tomáš	Cadet Kumite Male 70+ kg	
	SD55903	M	Nedoroscik Daniel	Junior Kata Male	
		M	Otrubčák Samuel	Junior Kata Male	
		M	Páleš Richard	Junior Kumite Male -68 kg	
	SVK02626	M	Papp Zoltán	U21 Kumite Male -75 kg	
		M	Pasnišin Maroš	Cadet Kumite Male -63 kg	
	SVK03132	M	Plichta Bruno	Junior Kumite Male -61 kg	
		M	Pšenák Matúš	Cadet Kumite Male -70 kg	
		M	Rešovský Daniel	Junior Kumite Male -61 kg	
		M	Rumanovsky Lukáš	U14 Kumite Male -40 kg	
	SVK02807	M	Sáraz Martin	Junior Kumite Male 76+ kg	
	SVK02501	M	Sečkář Šimon	U21 Kumite Male -84 kg	
	SVK02800	M	Šipkovský Jozef	Cadet Kata Male	
		M	Spáčil Samuel	Cadet Kata Male	
		M	Stuska Samuel	Cadet Kata Male	
	SVK02875	M	Turčaník Richard	Junior Kumite Male -76 kg	
		M	VERCIMAK MARTIN	U14 Kata Male	
		M	WEINREB Dominik	U21 Kata Male	
		F	Benešová Nina	Cadet Kumite Female -61 kg	
		F	Bírová Emma	U14 Kumite Female -42 kg	
		F	Breznanova Michaela	Cadet Kumite Female -61 kg	
		F	Budajová Ema	Cadet Kumite Female -47 kg	
	SD32292	F	Bytčanek Stella	Junior Kumite Female -48 kg	
		F	Čabanová Hanka	U14 Kumite Female 52+ kg	
		F	Černáková Olivia	U14 Kumite Female -42 kg	
		F	Dabin Juliette	U21 Kumite Female -61 kg	



Karate1 Youth League - Venice 2024



ENTRIES BY NATIONAL FEDERATION

As of 8 DEC 2024

Country Code	ID	Gender	Name	Event	Seed
SVK	SVK02761	F	Erdelyiova Nina	U21 Kumite Female 68+ kg	
		F	Fialková Sofia	Junior Kata Female	
		F	GAMOVA Natasa	U21 Kata Female	
	SD12132	F	Gáspárová Jessica	Cadet Kumite Female -61 kg	
		F	Glatzová Barbora	U21 Kata Female	
		F	Hrnčáriková Marika	U21 Kata Female	
	SD70975	F	Ilavská Kristína	Cadet Kumite Female -54 kg	
	SVK02589	F	Jalowiczorova Veronika	Junior Kumite Female -48 kg	
	SVK02644	F	Jeseníčová Nina	Junior Kumite Female -59 kg	
	SVK02760	F	KADLECAJOVA Viktoria	Junior Kata Female	
		F	Kalamárová Alexandra	U21 Kumite Female -68 kg	
		SD60750	F	KIŠŠKOVÁ KAROLÍNA	Cadet Kata Female
	F		KLEMPOVÁ Laura	U14 Kata Female	
	F		KLEMPOVÁ Laura	U14 Kumite Female -52 kg	
	SD77102	F	KLEMPOVÁ Linda	U14 Kumite Female 52+ kg	
		F	Kollárová Patrícia	Cadet Kumite Female -54 kg	
		SVK003248	F	Kretovičová Rita	Cadet Kumite Female 61+ kg
	F		Kulikova Vira	Junior Kumite Female -66 kg	
	SVK02345		F	Kvasnicova Nina	U21 Kumite Female -55 kg
	SVK02627	F	Malá Liliana	U21 Kumite Female -55 kg	
		F	Melicháreková Lenka	Junior Kumite Female -53 kg	
		F	Michalková Hannah	U14 Kata Female	
	SVK2289	F	Mierna Adriana	Junior Kumite Female -48 kg	
		F	MRÁZOVÁ LUCIA	U21 Kumite Female -50 kg	
		F	Nádašdiová Natália	Cadet Kumite Female -54 kg	
	SD77108	F	Póšová Lucia	U14 Kumite Female -52 kg	
		F	Rumanovska Zoe	Junior Kumite Female 66+ kg	
		F	Šatalová Soňa	U14 Kumite Female 52+ kg	
	SVK02805	F	Schneider Petra	U14 Kumite Female -52 kg	
		F	Sevcikova Natalia	U14 Kumite Female -52 kg	
		F	Ševčíková Viktória	Cadet Kumite Female -54 kg	
	SLO	F	Smatanová Ema	Cadet Kata Female	
		F	Streicherová Romana	Cadet Kumite Female -47 kg	
F		Vaczy Anna	U21 Kumite Female -61 kg		
SVK02805	F	Verebová Sára	Junior Kumite Female -48 kg		
	F	Viglašská Viktória	U14 Kumite Female -42 kg		
	F	WENDERLOVA MIRIAM	Cadet Kata Female		
SLO	F	Zelmanová Alzbeta	Cadet Kumite Female -61 kg		
	F	Zeumerova Alexandra	Junior Kumite Female -66 kg		
	M	AVDIBASIC DZENAN	Junior Kata Male		
SLO02685	M	BOZIC CENE	U21 Kumite Male -75 kg		
SLO02796	M	CICVARIC LUKA	Junior Kata Male		
SLO02925	M	ERDELIC ZAN	Cadet Kumite Male -57 kg		
SLO02571	M	FILIPIC MARK	Junior Kumite Male -61 kg		
SLO03039	M	GACIC ALEKSANDER	Junior Kumite Male 76+ kg		
SLO003076	M	GOSTISA VAN GENNIP NICK	Junior Kumite Male -68 kg		
SLO03040	M	KELEMAN VUK	Cadet Kumite Male -70 kg		



Karate1 Youth League - Venice 2024



ENTRIES BY NATIONAL FEDERATION

As of 8 DEC 2024

Country Code	ID	Gender	Name	Event	Seed
SLO	SLO02941	M	KRAMAR VILI	U14 Kata Male	
	SLO2417	M	KRZISNIK GAL	U21 Kumite Male 84+ kg	
	SLO02797	M	MESANOVIC BENJAMIN	U21 Kata Male	
	SLO02842	M	MILEV MATEJ	U14 Kumite Male -45 kg	
	SLO02563	M	MILJATOVIC ALEKSA	Cadet Kata Male	
	SLO02586	M	MLAKAR LUKA	Junior Kumite Male -76 kg	
		M	Oblak David Kerim	U14 Kumite Male -55 kg	
	SLO2353	M	OCKO GAL	Cadet Kumite Male 70+ kg	
	SLO02835	M	OVNIC TIAN	Cadet Kata Male	
	SLO003084	M	PIVIC EVELIN	U21 Kata Male	
	SLO02710	M	ROLA LUKA	Junior Kumite Male -68 kg	
	SLO003053	M	SEDONJA MATIJA	Cadet Kumite Male -63 kg	
	SLO2458	M	SLUGA JURE	U21 Kata Male	
		M	STERN TILEN	U14 Kumite Male -55 kg	
	SLO02990	M	STOJADINOVIC TIMOTEJ	Junior Kumite Male 76+ kg	
	SLO02633	M	Suša Žiga	U21 Kumite Male -67 kg	
		M	TRAMŠEK ALEKS	U14 Kumite Male -45 kg	
	SLO003075	M	VATOVEC ERNEST	Cadet Kumite Male -70 kg	
	SLO2427	M	ZARIC VID	U21 Kumite Male -67 kg	
	SLO2443	M	ZIBRET BOR	U21 Kumite Male -75 kg	
	SLO02701	F	BRACUN MASERA IRIS	Cadet Kata Female	
	SLO02701	F	BRACUN MASERA IRIS	Cadet Kumite Female 61+ kg	
	SLO02759	F	CERU JERNEJA	Junior Kumite Female -66 kg	
	SLO2415	F	HUMAR GAJA	Junior Kumite Female -66 kg	
	SLO02695	F	IVANCIC KIARA	U14 Kumite Female -47 kg	
	SLO03031	F	JERAM VITA	Cadet Kumite Female -47 kg	
	SLO02831	F	JERSIC ZANA	U14 Kata Female	
	SLO03035	F	KOTNIK NIKA	Junior Kumite Female -66 kg	
	SLO02940	F	KRAMAR LILI	Cadet Kata Female	
	SLO02926	F	KREGAR GABRIELA	Junior Kata Female	
	SLO03048	F	KRISTANCIC ZIVA	Cadet Kumite Female 61+ kg	
	SLO02690	F	KRVINA LIA	Cadet Kumite Female -61 kg	
	SLO02562	F	KURBEGOVIC EDNA	Junior Kumite Female -53 kg	
	SLO02889	F	KUTNJAK URSKA	Junior Kumite Female -48 kg	
	SLO02712	F	LEBEN TINKARA	Junior Kumite Female -59 kg	
	SLO2423	F	LISINOVIC ELMA	Junior Kata Female	
		F	MASTNAK MIA	U14 Kumite Female 52+ kg	
	SLO02719	F	MAVSAR TAJDA	Cadet Kata Female	
	SLO02564	F	MILJATOVIC ANDJELA	U14 Kata Female	
	SLO02689	F	MLAKAR NIKA	Cadet Kumite Female -54 kg	
	SLO02682	F	MUZIK TASA	U21 Kumite Female -68 kg	
	SLO02570	F	PISNIK MAJA-MARI	U14 Kata Female	
	SLO02846	F	PURIC ADRIJANA	U14 Kumite Female -52 kg	
		F	Rocco Ilaria	U14 Kumite Female -47 kg	
	SLO003071	F	TOMAZEVIC JULIJA	U14 Kumite Female -47 kg	
		F	TRAMŠEK ALJA	U14 Kumite Female -47 kg	
	SLO2448	F	ZIBRET ZALA MARIA	U21 Kumite Female 68+ kg	
	SLO02691	F	ZUPANCIC NANA	Cadet Kumite Female -54 kg	



Karate1 Youth League - Venice 2024



ENTRIES BY NATIONAL FEDERATION

As of 8 DEC 2024

Country Code	ID	Gender	Name	Event	Seed
ESP		M	ALCALA JIMENEZ ALBERTO	Cadet Kata Male	
		M	ALCALA JIMENEZ ALBERTO	Cadet Kumite Male -63 kg	
		M	Alonso Céspedes Héctor	U21 Kata Male	
		M	ALVAREZ FERNANDEZ IZAN	Cadet Kata Male	
		M	Apellaniz Unai	U14 Kumite Male -45 kg	
		M	ASPERILLA DIAZ RUBÉN	Junior Kumite Male -76 kg	
		M	Ayerdi Oihan	Cadet Kumite Male -52 kg	
	ESP02997	M	BAEZ RODRIGUEZ CRISTOBAL	Junior Kumite Male -68 kg	
		M	Benitez Espuela David	Junior Kumite Male -61 kg	
	ESP003957	M	Benito Medina Raul	Cadet Kumite Male -70 kg	
		M	CARMONA DIAZ ENRIQUE	Junior Kata Male	
		M	Castro López Braulio	Cadet Kata Male	
		M	Chaibi Soufian	Cadet Kumite Male -52 kg	
		M	CONTRERAS CABRERA DIEGO ANDRÉS	U21 Kata Male	
		M	Corpas Coronado Ramon Jesus	U21 Kumite Male -60 kg	
		M	DOMINGUEZ PRIEGO JOSE MANUEL	Cadet Kumite Male -52 kg	
		M	Echevarría Lavín Manuel	U21 Kumite Male 84+ kg	
		M	ESCOBAR JARA DANIEL JOSE	Junior Kumite Male -68 kg	
		M	escutia manchola Salvador	U14 Kumite Male -40 kg	
		M	ESPARZA GONZALO	U21 Kumite Male -60 kg	
		M	FEO CABO VICTOR	U21 Kumite Male -67 kg	
	ESP56636	M	FERNANDEZ GONZALEZ SERGIO	Junior Kumite Male -55 kg	
		M	Fernández Maza Paul	Junior Kumite Male -68 kg	
		M	FERNANDEZ PERIS SANTIAGO	U21 Kumite Male -75 kg	
		M	Fontenlos Ferreiro Samuel	Junior Kumite Male -61 kg	
		M	Gonzalez Hugo	U14 Kata Male	
		M	GUTIERREZ SANZ SAUL	Junior Kumite Male 76+ kg	
		M	IGLESIAS GARCÍA MANUEL	U21 Kata Male	
		M	KARACH REVERTE USAMA	Junior Kata Male	
		M	LACUEVA MARTINEZ GENIS	Cadet Kata Male	
		M	LACUEVA MARTINEZ GENIS	Cadet Kumite Male -70 kg	
	ESP02871	M	Leal Moreno Iker	Junior Kumite Male -76 kg	
		M	LEÓN DE LA PEÑA JOSE ANGEL	Cadet Kata Male	
		M	LLEÓ DE SMET JORGE	U14 Kata Male	
		M	Lopez Milan Mario	U14 Kata Male	
		M	Lopez Milan Mario	U14 Kumite Male -55 kg	
		M	Maestre Barreda Jose	Junior Kumite Male -61 kg	
		M	MARTINEZ JIMENEZ PABLO	Junior Kumite Male -76 kg	
		M	Martin Peña Izan	Junior Kumite Male -76 kg	
		M	mateo antunez cesar	Cadet Kumite Male -63 kg	
		M	MATHISON LION LEANDRO ANDRES	U14 Kata Male	
	SD74628	M	Mazo Marco	Cadet Kumite Male 70+ kg	
	ESP02865	M	MIRESAN SECHEI CRISTIAN ALEXANDRU	Junior Kumite Male 76+ kg	
		M	MORATA SANCHEZ CARLOS	Junior Kumite Male -68 kg	
		M	Morillo Lozano Israel	Cadet Kumite Male -63 kg	
		M	Olmos David	U14 Kumite Male -50 kg	



Karate1 Youth League - Venice 2024



ENTRIES BY NATIONAL FEDERATION

As of 8 DEC 2024

Country Code	ID	Gender	Name	Event	Seed
ESP		M	ORTEGA RUIZ SANTIAGO	Junior Kumite Male -61 kg	
		M	ORTIZ RUEDA JORGE	Cadet Kata Male	
		M	ORTIZ RUEDA JORGE	Cadet Kumite Male -52 kg	
		M	PEREZ DE ANUZITA GARCÍA ORIOL	Cadet Kumite Male -52 kg	
		M	PEREZ LORITE JORGE	Junior Kumite Male -55 kg	
		M	PEREZ MATA DANIEL	U14 Kumite Male -45 kg	
	SD51060	M	PETAGNA PAOLO	Cadet Kumite Male -63 kg	
		M	QUESADA TORRES IVAN	Cadet Kumite Male -57 kg	
		M	Quinto Gomez Jesus	Junior Kata Male	
		M	Quinto Gomez Jesus	Junior Kumite Male -55 kg	
		M	Ramírez Rivas Adrian	U14 Kata Male	
		M	RODRIGUEZ FUENTES ENRIQUE	U14 Kumite Male -55 kg	
		M	ROMAN MARTIN DAVID	Cadet Kumite Male -70 kg	
		M	Souto Iglesias Anton	Junior Kata Male	
	ESP02999	M	TAMAYO RUIZ BORJA	Junior Kumite Male -76 kg	
	ESP56635	M	VISO NAVARRO HUGO	Junior Kumite Male 76+ kg	
		F	ALCALA JIMENEZ IRENE	Junior Kumite Female -59 kg	
		F	Andres Paula	U21 Kumite Female -68 kg	
		F	ANGUERA NIETO JUDITH	Junior Kata Female	
		F	ANGUERA NIETO JUDITH	Junior Kumite Female -59 kg	
	ESP03036	F	Apellániz Oihane	Junior Kumite Female -53 kg	
		F	Ayerdi Naroa	Cadet Kumite Female -47 kg	
		F	BAEZ RODRIGUEZ DANIELA	U14 Kumite Female -47 kg	
		F	Balbontin Sanz Paula	Junior Kumite Female 66+ kg	
		F	Balbontin Sanz Sandra	Junior Kumite Female 66+ kg	
		F	BEJARANO VILLANUEVA MIREIA	U21 Kumite Female -68 kg	
		F	Benedicto Acosta Ariadna	Cadet Kata Female	
		F	Bustamante DANIELA	Cadet Kumite Female -54 kg	
		F	Castro López Rocío	Cadet Kata Female	
		F	Chaibi Ouiam	U21 Kumite Female -55 kg	
		F	COLLADO SANTANO ALBA	Junior Kumite Female 66+ kg	
		F	COMELLA NEVADO CATERINA	Cadet Kata Female	
		F	CORONADO GIMENEZ SOFIA	U21 Kumite Female -55 kg	
		F	DURÁN PAVÓN EVA	Junior Kata Female	
		F	DURÁN PAVÓN EVA	Junior Kumite Female -66 kg	
	ESP03000	F	EGEA COLADO MARIA	Junior Kumite Female -59 kg	
		F	FEO CABO ANDREA	Junior Kumite Female -53 kg	
		F	Folgueira González Uxia	U14 Kata Female	
		F	Folgueira González Uxia	U14 Kumite Female -52 kg	
		F	GARCIA RUIZ AINHOA	U14 Kumite Female -47 kg	
		F	GARCIA RUIZ NADIRA	Cadet Kumite Female -47 kg	
		F	GINÉS CHAVARRY PAULA	U14 Kumite Female 52+ kg	
		F	GÓMEZ SALGADO CARMEN	Cadet Kumite Female -47 kg	
		F	Guardeño Leon Carla	U21 Kata Female	
		F	Guardeño Leon Carla	U21 Kumite Female -50 kg	
		F	HERNANDEZ CASTILLA JULIA	Cadet Kumite Female 61+ kg	
	ESP03003	F	JUST CLOPES JÚLIA	Junior Kumite Female -59 kg	
		F	Lazaro fernandez Lucia	Junior Kumite Female -66 kg	



Karate1 Youth League - Venice 2024



ENTRIES BY NATIONAL FEDERATION

As of 8 DEC 2024

Country Code	ID	Gender	Name	Event	Seed		
ESP		F	MACIA RAQUEL	U21 Kumite Female -68 kg			
		F	Mallegni Marta	Junior Kata Female			
		F	MARTIN ALBA	U21 Kata Female			
	ESP03478		F	MARTI MARCO SARA	Junior Kumite Female -48 kg		
			F	MATOS PERAL LOLA	Junior Kumite Female -48 kg		
			F	MELGAR POSTIGO JULIA MARIA	U14 Kumite Female -52 kg		
			F	NASARRE SÁNCHEZ AROA	Cadet Kumite Female -61 kg		
			F	NASARRE SÁNCHEZ IRENE	Junior Kumite Female 66+ kg		
		ESP03480		F	PALLEIRO CARBALLO BEATRIZ	Junior Kata Female	
			F	PARACUELLOS ELICES LOLA	Cadet Kumite Female -54 kg		
			F	PEÑA GARCIA CANDELA	U14 Kata Female		
			F	Quinto Gomez Luna	U14 Kata Female		
			F	Quinto Gomez Luna	U14 Kumite Female -52 kg		
			F	RAMIREZ GRANDE ERIKA	Junior Kumite Female 66+ kg		
			F	RAMIREZ ORTEGA PAULA	U21 Kumite Female 68+ kg		
			F	RÍO CARAVANTES JÚLIA	Cadet Kata Female		
			F	RIVAS JIMENEZ CRISTINA	Junior Kumite Female -59 kg		
			F	RODRÍGUEZ MARTÍNEZ ARIADNA	Cadet Kata Female		
			F	RODRÍGUEZ MARTÍNEZ ARIADNA	Cadet Kumite Female -61 kg		
			F	RUIZ DELGADO SILVIA M ^a	Junior Kumite Female 66+ kg		
			F	SHURMELIOUA LIUBAS STELA	Cadet Kumite Female -47 kg		
			F	SIGÜENZA CRUCES SANDRA	Cadet Kata Female		
			F	SIGÜENZA CRUCES SANDRA	Cadet Kumite Female -54 kg		
			F	SKIBA BIRKELBACH AMELIE YAIZA	Cadet Kumite Female -61 kg		
			F	VAZQUEZ GARCIA CECILIA	U14 Kumite Female 52+ kg		
			F	VICENTE MATEO EVA	U21 Kata Female		
			F	VIZCAINO CALVO RUTH	Junior Kumite Female -53 kg		
	ESP02675			F	VIZUETE MIREIA	U21 Kumite Female -50 kg	
	SWE			M	Andersson Jöhnk Emil	U14 Kumite Male +55 kg	
			SWE02691	M	BECHTIOUI TAHA	Junior Kumite Male -61 kg	
SWE003198			M	DURDEVIC NIKOLA	Junior Kumite Male -76 kg		
			M	Durling Charlie	U14 Kumite Male -45 kg		
SWE02427		M	HAAG OZZY	U21 Kumite Male -84 kg			
SWE003127		M	HASSAS JACOB	Junior Kumite Male -68 kg			
SWE003124		M	JONASSON JAKOB	Cadet Kata Male			
SWE03085		M	LARSSON ERHARDT TRULS	Cadet Kata Male			
		M	Leinsköld William	Junior Kata Male			
		M	Mahmic Elvin	U14 Kumite Male -45 kg			
		M	Mustafa Hassan	U14 Kumite Male -40 kg			
		M	Mustafa Josef	Cadet Kumite Male -52 kg			
SWE003122		M	NASER AHMED	Junior Kumite Male -68 kg			
		M	Palm Arthur	Cadet Kumite Male -57 kg			
		M	Pettersson Ilias	Junior Kata Male			
SWE02428		M	Rosenlind Viktor	U21 Kumite Male -67 kg			
SWE02904		M	SKOTTESTAD ISAK	Junior Kata Male			
SWE02388		M	TRAN WILLIAM	U21 Kata Male			
SWE02480	F	BAO BEDNARSKI SOPHIE	U21 Kumite Female 68+ kg				



Karate1 Youth League - Venice 2024



ENTRIES BY NATIONAL FEDERATION

As of 8 DEC 2024

Country Code	ID	Gender	Name	Event	Seed			
SWE	SWE 03084	F	Engdahl Leilani	Junior Kumite Female -48 kg				
		F	Erhardt Signe	U14 Kumite Female -42 kg				
		F	Jakesevic Ivana	Junior Kumite Female -66 kg				
		F	Karlsson Leila	Cadet Kata Female				
	SWE		F	Lyngbäck Agnes	U21 Kata Female			
			F	Mahmic Sara	Cadet Kumite Female -54 kg			
	SWE02686		F	NYMAN AGNES	Junior Kumite Female -48 kg			
			F	Tesic Aleksandra	Cadet Kumite Female -54 kg			
	SWE003123		F	Vapper Minou	Cadet Kata Female			
			F	WAHLSTROM MEJA	Junior Kumite Female 66+ kg			
SWE003235		F	Wohlgemuth Naiya	U21 Kumite Female -61 kg				
		F	Zarei Lara	U21 Kumite Female -68 kg				
SUI	SUI02692	M	Alfonso Perez Eloy	Cadet Kumite Male -52 kg				
		M	Bandelier Mathis	Junior Kumite Male 76+ kg				
		M	Giaquinto Daniele	Cadet Kumite Male -52 kg				
		M	Gloor Leon	U14 Kumite Male -55 kg				
		M	Häusermann Aaron	U14 Kumite Male -40 kg				
		M	Iseppi Nevio	U14 Kata Male				
		M	Iseppi Nevio	U14 Kumite Male -50 kg				
		SUI02276		M	Jost Ruben	U21 Kumite Male -60 kg		
				M	KARLEN Théo	Junior Kumite Male -68 kg		
		SUI02734		M	Khames Ahmad	U21 Kumite Male -60 kg		
	M			Kühl Bjarne	U14 Kumite Male +55 kg			
	M			Limacher Ramon	Cadet Kata Male			
	SUI02269				M	Lorenz Swan	U21 Kumite Male -67 kg	
					M	Lüthi Moritz	Cadet Kumite Male -63 kg	
	M			Lüthy Corsin Dion	Cadet Kata Male			
	M			Lüthy Corsin Dion	Cadet Kumite Male -52 kg			
	M			Mateus Gomes Cristiano	Cadet Kumite Male -52 kg			
	M			Mateus Gomes Leonardo	Cadet Kumite Male -52 kg			
	SUI02603				M	Meier Nikita	U14 Kumite Male -40 kg	
		M	Mischler Kevin		Junior Kata Male			
		M	Oberson Antoine		U21 Kumite Male -75 kg			
		M	Patricio--Clémont Johan		Cadet Kumite Male -57 kg			
	SUI02697		M	Pedro Théo	Junior Kumite Male -76 kg			
	SUI003155		M	PETRONE Leandro	U21 Kata Male			
	SUI02267		M	Sanarica Niccolo	U21 Kumite Male -75 kg			
	SUI02236		M	Schedel Keni	U21 Kata Male			
	SUI02743		M	Schedel Nolan	Junior Kata Male			
	SUI02274		M	Schertenleib Janik Timo	U21 Kata Male			
			M	Sengebusch Aaron	Cadet Kumite Male -52 kg			
			M	Sieber Elija	Junior Kumite Male -68 kg			
M			Soliaryk Platon	Cadet Kumite Male -70 kg				
SUI02282				M	Torres Steven	U21 Kumite Male -67 kg		
				M	Tscharner Loan	Junior Kumite Male -68 kg		
M			Zecca Lucas	Cadet Kumite Male -52 kg				
F			Alari Susan	Cadet Kumite Female 61+ kg				



Karate1 Youth League - Venice 2024



ENTRIES BY NATIONAL FEDERATION

As of 8 DEC 2024

Country Code	ID	Gender	Name	Event	Seed
SUI		F	Arifagic Almina	Cadet Kumite Female 61+ kg	
	SUI02568	F	Bonny Shani'a	U21 Kumite Female 68+ kg	
	SUI02240	F	Bosshard Lea	U21 Kumite Female -61 kg	
	SD59759	F	BOUTRACIT AÏCHA	U21 Kumite Female -50 kg	
	SUI02270	F	Buchser Anel	U21 Kata Female	
		F	Bürki Danicha	Junior Kumite Female -59 kg	
	SUI02417	F	Burri Liliane	U21 Kumite Female -61 kg	
		F	Campell Larissa	Cadet Kata Female	
		F	Dumitras Pia	Cadet Kumite Female -54 kg	
	SUI02280	F	Duperrex Oksana	U21 Kumite Female -61 kg	
		F	Eiselt Zoe	Junior Kata Female	
	SUI02684	F	Gallimore Kim	U21 Kata Female	
		F	Gaus Anja	Junior Kumite Female -53 kg	
		F	Gibril Hiba	Cadet Kumite Female 61+ kg	
		F	Golubovic Inija	U14 Kata Female	
		F	Guye Nina	Junior Kumite Female -66 kg	
		F	Hermenier Norah	Cadet Kumite Female 61+ kg	
		F	Jenic Andrijana	U21 Kumite Female 68+ kg	
		F	Karadeniz Ecrin	Junior Kumite Female -59 kg	
	SUI SD55986	F	Latsis Maria	U14 Kata Female	
		F	Marano Leonia Mya	U14 Kumite Female 52+ kg	
		F	Michaud Zoé	Cadet Kata Female	
		F	Mühlemann Noemi	Cadet Kumite Female -61 kg	
		F	NÄF Sylvie	Cadet Kumite Female -47 kg	
	SUI03111	F	Özdemir Demet	Cadet Kata Female	
	SUI03111	F	Özdemir Demet	Cadet Kumite Female -47 kg	
		F	Paul-Jacques Juline	Junior Kumite Female -53 kg	
		F	Payziner Serena	Cadet Kumite Female -47 kg	
	SUI02567	F	Pelladoni Gina	U21 Kata Female	
		F	Redzic Esma	Cadet Kumite Female 61+ kg	
	SUI02740	F	Ritz Lila	Junior Kata Female	
	SUI02739	F	Ritz Maia	Cadet Kata Female	
		F	Sanneh Fatumata	Cadet Kumite Female -61 kg	
	SUI003225	F	Schedel Kaena	Cadet Kata Female	
	SUI02566	F	Streit Kim Lara	Junior Kumite Female -53 kg	
		F	Streit Mila Chiara	Cadet Kumite Female -47 kg	
	SUI02329	F	Thomaidis Keara	U21 Kumite Female -61 kg	
	SUI02277	F	Tschanz Olivia	U21 Kata Female	
		F	Tscharner Anais	Cadet Kumite Female -54 kg	
		F	von Klass Melissa	Cadet Kumite Female -47 kg	
		F	WIDMER Alisha	U14 Kumite Female -47 kg	
SYR		M	Kashash Thaer	Cadet Kumite Male -70 kg	
		F	Kashash Nour	Junior Kumite Female 66+ kg	
TTO	TRI02132	F	LUE FATT MICHELLE	U21 Kata Female	
	TRI02131	F	LUE FATT ROSHELLE	U21 Kumite Female -50 kg	
TUN	TUN003472	M	CHARABI MOHAMED YASINE	U14 Kumite Male -55 kg	



Karate1 Youth League - Venice 2024



ENTRIES BY NATIONAL FEDERATION

As of 8 DEC 2024

Country Code	ID	Gender	Name	Event	Seed
TUN	TUN02803	F	Ettaleb Meriame	U21 Kumite Female -68 kg	
TUR		M	AKGUL BARIS	U21 Kumite Male -60 kg	
	TUR03810	M	AKKAYA ALISAN	U21 Kumite Male -60 kg	
		M	Altın Muhammet Emir	Cadet Kumite Male -70 kg	
	TUR03730	M	ASLAN Kagan	Junior Kumite Male -61 kg	
		M	Aslantaş Deniz	Cadet Kumite Male -63 kg	
		M	aydemir süleyman	U21 Kumite Male -84 kg	
		M	AYDIN AHMET SAIT	U14 Kumite Male -50 kg	
		M	BAYIR BATUHAN	Junior Kumite Male -55 kg	
		M	BEKTAŞ KAĞAN BERK	U14 Kumite Male -40 kg	
	TUR2945	M	çalışkan eyüp can	Junior Kata Male	
		M	Coşkun Fevzi Emir	U14 Kumite Male -40 kg	
		M	Demirci Kayra Nejan	U14 Kumite Male -55 kg	
		M	Felhan Salih	U14 Kumite Male -50 kg	
		M	Karakozak Nadir efe	Cadet Kumite Male 70+ kg	
		M	kaya melih	U21 Kumite Male 84+ kg	
	TUR2681	M	KELES Osman Burak	Junior Kumite Male -76 kg	
		M	Kılıç Kaan Emre	U14 Kumite Male +55 kg	
		M	KIRAT YİĞİT	Cadet Kumite Male -52 kg	
	TUR3045	M	KOÇ TARIK	Junior Kata Male	
		M	KUTUK UTKU TAHA	Cadet Kumite Male -70 kg	
		M	Naimoğlu Melih Tarık	U14 Kata Male	
	TUR03707	M	OGUS SAVAS	Junior Kumite Male -61 kg	
		M	ÖZDEN ÖMER ALPEREN	U14 Kumite Male +55 kg	
		M	OZER EGE	U14 Kumite Male -50 kg	
		M	ÖZTÜRK AHMET	U21 Kumite Male -67 kg	
		M	Parlak Ozan	U21 Kata Male	
		M	TAŞ ILGAZ	U14 Kumite Male +55 kg	
		M	TÜKEN İBRAHİM HALİL	U14 Kumite Male -40 kg	
		M	Usta Arda	Junior Kumite Male -55 kg	
		M	YAĞLI KAYRA	Cadet Kumite Male 70+ kg	
		M	YAĞLI KEREM TUĞRA	Junior Kumite Male 76+ kg	
		M	YILDIRIM ATEŞ EFE	U21 Kata Male	
	TUR03745	F	AKKAYA ZEYNEP	U21 Kumite Female -50 kg	
		F	AKSOY Damla	Cadet Kumite Female -47 kg	
		F	AKSOY Duru	Cadet Kumite Female -47 kg	
		F	AKTAŞ Aymin Ege	U14 Kata Female	
	TUR03818	F	ASLAN Ezgi	Junior Kumite Female -59 kg	
		F	AYDEMİR YAGMUR	Junior Kumite Female -66 kg	
		F	AYVACIK Nisanur	Junior Kumite Female -53 kg	
		F	BOZBEY YÜSRA	U14 Kata Female	
		F	ÇAKIR NİSANUR	Junior Kumite Female -53 kg	
		F	ÇAKIR ZEYNEP ERVA	Cadet Kumite Female -47 kg	
		F	ÇÜMEN ECE	U14 Kumite Female 52+ kg	
		F	DOGAN ELIF BERRE	Cadet Kumite Female -47 kg	
		F	ERASLAN ESMANUR HÜMEYRA	U14 Kumite Female -52 kg	
		F	EREVİK Ceylin	Cadet Kumite Female -47 kg	



Karate1 Youth League - Venice 2024



ENTRIES BY NATIONAL FEDERATION

As of 8 DEC 2024

Country Code	ID	Gender	Name	Event	Seed
TUR		F	GUNDOGDU ECRİN	U14 Kumite Female 52+ kg	
		F	GÜRBÜZ BEYZA YAĞMUR	U14 Kumite Female -47 kg	
		F	GURBUZ TURNA	U14 Kumite Female -47 kg	
		F	ISIK SİMAY	Cadet Kumite Female -47 kg	
		F	Karadeniz Mihrap	U21 Kumite Female -50 kg	
	TUR3007	F	KILIÇ BUSE	Junior Kumite Female -53 kg	
	TUR2973	F	KILIÇ NEHİR	Junior Kumite Female -53 kg	
		F	KILINÇ KÜBRA	U14 Kumite Female -42 kg	
		F	KOCAKAPLAN NURAHSEN	U14 Kumite Female -42 kg	
		F	OKUMUS CEYDA SU	U14 Kumite Female 52+ kg	
		F	Oytun Sıla	Junior Kumite Female -53 kg	
		F	SARIKAYA YAREN ELİF	U14 Kumite Female 52+ kg	
		F	TEKCAN EYLÜL	Junior Kumite Female -53 kg	
		F	TOPATAN CEYLA	U14 Kata Female	
		F	tural esem sude	Junior Kumite Female -59 kg	
		F	YALIN MESUDE	Junior Kumite Female -66 kg	
	TUR03719	F	YILDIRIM Defne Eda	Junior Kumite Female -48 kg	
		F	YILDIRIM LEYLANUR	U14 Kumite Female -42 kg	
		F	YONAK NEHIR	Junior Kumite Female -66 kg	
	TKM	TKM02131	M	AMANDURDYEV GURBANNAZAR	Cadet Kumite Male -52 kg
TKM02335		M	ANNAYEV MAGTYMGULY	U21 Kumite Male -60 kg	
TKM02034		M	ATAJANOV RASUL	U21 Kata Male	
TKM02034		M	ATAJANOV RASUL	U21 Kumite Male -60 kg	
TKM002689		M	BAYRAMOV BAYRAMGELDI	Junior Kumite Male -61 kg	
TKM02545		M	GARAMAMMEDOV GARAMAMMET	U21 Kumite Male -60 kg	
TKM02656		M	GURBANOV REMEZAN	Cadet Kumite Male -52 kg	
TKM02655		M	JEYHUNOV MYRAT	Cadet Kumite Male -70 kg	
TKM02654		M	JUMANOV SERDAR	Cadet Kumite Male -63 kg	
TKM02549		M	KAKALYYEV ALYMUHAMMET	Cadet Kumite Male -57 kg	
TKM02618		M	KELETLIYEV DAYANCH	U21 Kumite Male -67 kg	
TKM02341		M	KISELYOV BOGDAN	Cadet Kumite Male -52 kg	
TKM02133		M	OVEZMYRADOV JORA	Junior Kumite Male -55 kg	
TKM02328		M	SAPADURDYEV OVEZMYRAT	U14 Kata Male	
TKM02328		M	SAPADURDYEV OVEZMYRAT	U14 Kumite Male -40 kg	
TKM02653		M	SAPAROV SULEYMAN	Junior Kumite Male -68 kg	
TKM002696		M	SULEYMANOV RAHYM	Junior Kumite Male -55 kg	
TKM002690		M	SULEYMANOV RESUL	U21 Kumite Male -75 kg	
TKM02132		M	YALKABOV ALLANUR	Cadet Kata Male	
UKR			M	AVILOV ARTEM	Junior Kumite Male -55 kg
		M	Avramenko Roman	U14 Kumite Male -50 kg	
		M	Baiol Mykola	U14 Kumite Male +55 kg	
		M	Barbadyn Roman	U14 Kumite Male +55 kg	
		M	BEKESHKO IVAN	U14 Kumite Male -50 kg	
	UKR02713	M	Bessarabov Anatolii	U21 Kumite Male -67 kg	
		M	Bilenkyi Oleksandr	U14 Kumite Male -55 kg	
		M	BILOKON BOHDAN	U14 Kumite Male -55 kg	
	UKR03060	M	Bilous Danylo	Junior Kumite Male -76 kg	



Karate1 Youth League - Venice 2024



ENTRIES BY NATIONAL FEDERATION

As of 8 DEC 2024

Country Code	ID	Gender	Name	Event	Seed
UKR		M	Bilous Illia	U14 Kata Male	
		M	Bilous Ivan	Junior Kata Male	
		M	Boiko Dmitrii	U14 Kumite Male -55 kg	
		M	BONDUR VLADYSLAV	U14 Kumite Male -40 kg	
		M	Chubun Nazar	U14 Kumite Male -40 kg	
		M	Davyd Hasanov	U14 Kumite Male -45 kg	
		M	Dorosh Mark	U14 Kumite Male -45 kg	
		M	Drahun Rodion	U14 Kumite Male -45 kg	
		M	Duchenko Tymur	Junior Kata Male	
		M	Fedorchak Maksym	U14 Kumite Male -40 kg	
	UKR2366	M	Fedorov Yaroslav	U21 Kata Male	
		M	Fedorov Yevhenii	Cadet Kumite Male -57 kg	
	UKR02697	M	Fedotov Dmytro	U21 Kumite Male -67 kg	
		M	Fomitskyi Ihor	Cadet Kumite Male -52 kg	
		M	GRES PLATON	U14 Kumite Male +55 kg	
	UKR03076	M	Herus Oleh	U21 Kumite Male -84 kg	
	SD48959	M	Hlushchenko Artur	Junior Kata Male	
	SD48959	M	Hlushchenko Artur	Junior Kumite Male -76 kg	
		M	HLUSHKO TYMOFII	U14 Kumite Male -50 kg	
		M	Hlushku Nikita	U14 Kumite Male -40 kg	
		M	Hrebenozhko Danylo	U14 Kumite Male -40 kg	
		M	Hromovyi Ruslan	U14 Kumite Male +55 kg	
	UKR03141	M	HRYNENKO ILLIA	Junior Kumite Male -68 kg	
		M	Hulin Nikita	U21 Kumite Male 84+ kg	
		M	Ilchuk Savelii	Cadet Kumite Male -52 kg	
		M	Ilnytskyi Illia	Cadet Kumite Male -63 kg	
		M	Ivankov Oleh	U14 Kumite Male -45 kg	
		M	Kanivets Vladyslav	Cadet Kumite Male -63 kg	
	UKR02689	M	KASIANOV DANIIL	U21 Kumite Male 84+ kg	
	UKR03069	M	Khablo Danylo	Junior Kata Male	
		M	KHODAKOVSKYI YEVSEVII	U14 Kumite Male -40 kg	
		M	KINASH YAROSLAV	Cadet Kumite Male 70+ kg	
	UKR03147	M	KIRIA HELA	Junior Kumite Male 76+ kg	
		M	Kononov Maksym	U14 Kumite Male -55 kg	
	UKR02879	M	Kosarych Andrii	U21 Kumite Male -84 kg	
	UKR03148	M	KOSTIUKOV TYMUR	Junior Kumite Male -76 kg	
	SD49020	M	Kovalchuk Arsen	Junior Kumite Male -76 kg	
		M	Kozachenko Maksym	Cadet Kumite Male -63 kg	
	UKR02451	M	Kozachok Oleksandr	U21 Kumite Male -84 kg	
		M	Kozak Kostiantyn	Cadet Kumite Male -70 kg	
		M	KOZAK TYMOFII	Junior Kumite Male -61 kg	
		M	Kozlovskyi Artem	Junior Kumite Male -61 kg	
	UKR02868	M	Kozylian Oleksandr	U21 Kumite Male 84+ kg	
		M	Krylovskyi Yurii	U14 Kumite Male -45 kg	
		M	Kucherenko Vasyl	Cadet Kumite Male -57 kg	
		M	KULCHYTSKYI VLADYSLAV	Junior Kumite Male -55 kg	
		M	Kunitskyi Oleh	U14 Kumite Male -40 kg	
		M	Kurinov Daniil	U14 Kumite Male -50 kg	



Karate1 Youth League - Venice 2024



ENTRIES BY NATIONAL FEDERATION

As of 8 DEC 2024

Country Code	ID	Gender	Name	Event	Seed
UKR		M	KVAS ANDRII	Junior Kumite Male -55 kg	
		M	Leshchuk Yehor	U14 Kumite Male +55 kg	
		M	LIESKOVSYYI ILLIA	U14 Kumite Male -40 kg	
		M	Lisovyi Vadym	Junior Kumite Male -76 kg	
	UKR03008	M	Lomovatskyi Hlib	U21 Kumite Male -60 kg	
		M	Lypivskyi Daniil	U14 Kumite Male +55 kg	
		M	Makoviichuk Taras	Cadet Kumite Male -57 kg	
		M	MAKSYMENKO KIRIL	Cadet Kata Male	
		M	Malchenko Heorhii	U14 Kumite Male -40 kg	
		M	Manzaruk Arystarkh	U14 Kumite Male -45 kg	
		M	Manzhula Matvii	Cadet Kumite Male -57 kg	
		M	MARCHENKO OLEKSII	U14 Kata Male	
		M	MARCHENKO OLEKSII	U14 Kumite Male -50 kg	
		M	MARYSENKO BOHDAN	U14 Kumite Male -50 kg	
		M	MATSENKO IVAN	U14 Kumite Male -50 kg	
		M	Matseruk Oleksandr	Junior Kumite Male -76 kg	
		M	Matveiev Artur	U14 Kumite Male -45 kg	
		M	MATVIEIEV KYRYL	Cadet Kumite Male -57 kg	
		M	Melnyk Yevhenii	U14 Kumite Male -40 kg	
	UKR02452	M	Mezentsev Zakhar	U21 Kumite Male -60 kg	
		M	MIKHNO MARK	U14 Kumite Male -40 kg	
		M	MOLCHANOV NIKITA	U14 Kumite Male -45 kg	
		M	Moroz Borys	U14 Kumite Male -40 kg	
		M	MUZYCHKA USTYM	U14 Kumite Male +55 kg	
		M	Nechypurenko Vitalii	Cadet Kata Male	
		M	Nevozhai Maksym	Junior Kata Male	
		M	Nikulcha Yuri	Junior Kumite Male -55 kg	
	UKR03064	M	Nimizhan Stanislav	Junior Kumite Male -76 kg	
		M	Odynets Oleksandr	U14 Kumite Male -45 kg	
		M	Osadchyi Semen	U14 Kumite Male +55 kg	
	UKR02531	M	Ovras Oleh	U21 Kumite Male -75 kg	
		M	Ozoruba Nazarii	Junior Kumite Male -68 kg	
	SD48414	M	PAKHOMOV HLIB	Junior Kumite Male -76 kg	
	UKR02528	M	PANCHUK ARTEM	U21 Kumite Male -75 kg	
		M	PANKRATOV ROSTYSLAV	U14 Kumite Male -55 kg	
		M	Petrov Serhii	U14 Kumite Male -55 kg	
	UKR02970	M	PIANTKIVSKYYI DENYS	U21 Kumite Male -75 kg	
		M	Piekhtieriev Mykhailo	Cadet Kumite Male -70 kg	
	UKR02683	M	Pitsul Heorhii	U21 Kumite Male -75 kg	
		M	Pomeranets Ihor	U14 Kumite Male +55 kg	
		M	POTAPOV ARTEM	U14 Kumite Male +55 kg	
	UKR03066	M	Pranychuk Nazarii	Junior Kumite Male -61 kg	
		M	Protasenko Andrii	U14 Kumite Male -55 kg	
		M	Pryima Roman	U14 Kumite Male -50 kg	
		M	Pryndiuk Artem	U14 Kumite Male -55 kg	
		M	RADKOVSKYYI ANDRIY	U14 Kumite Male -50 kg	
		M	Ravliuk Dmytro	Junior Kumite Male -76 kg	
		M	Remeslo Mykhaylo	Cadet Kumite Male 70+ kg	



Karate1 Youth League - Venice 2024



ENTRIES BY NATIONAL FEDERATION

As of 8 DEC 2024

Country Code	ID	Gender	Name	Event	Seed		
UKR	UKR02869	M	RUDENKO ARSENII	Junior Kumite Male -55 kg			
		M	RUDENKO KLYMENTII	U14 Kata Male			
		M	RUDENKO KLYMENTII	U14 Kumite Male -40 kg			
		M	Rudenko Vladyslav	Cadet Kumite Male 70+ kg			
		M	Rudniev Kyryl	U14 Kumite Male -45 kg			
		M	Ryha Andrii	U14 Kumite Male -55 kg			
		M	Sagrunov Oleksandr	U14 Kumite Male -50 kg			
		M	Savytskyi Mykhailo	U14 Kumite Male -50 kg			
		M	SEIKO VOLODYMYR	U14 Kumite Male -40 kg			
		M	SEMENCHENKO DENYS	U14 Kumite Male -45 kg			
		M	Shakhov Mykola	Cadet Kumite Male -70 kg			
		M	Shchemelov Tymofii	U14 Kumite Male -45 kg			
		M	Sheremet Dmytro	Junior Kumite Male -55 kg			
		M	Shulha Vadym	U14 Kumite Male -40 kg			
		M	Shumovych Mykhailo	Junior Kumite Male -68 kg			
		UKR02443	UKR02443	M	SHVEDA VLADYSLAV	U21 Kumite Male -75 kg	
		UKR02541	UKR02541	M	Skrypnyk Artem	U21 Kata Male	
				M	Smokvin Oleksandr	U21 Kumite Male -67 kg	
		UKR02919	UKR02919	M	Sokha Nazar	Junior Kumite Male -55 kg	
				M	SOKOLOV HLIB	U21 Kata Male	
				M	STANKOV SERHII	Junior Kumite Male -61 kg	
				M	Stepanov Tymur	U14 Kumite Male -40 kg	
				M	STRYZHEVSKYI DAVID	Cadet Kumite Male -57 kg	
M	TADA KYRYLO			U14 Kumite Male -55 kg			
M	Tahiev Yevhen			U14 Kumite Male +55 kg			
M	Talama Artur			Cadet Kumite Male -70 kg			
M	TARASENKO ARTEM			Junior Kumite Male 76+ kg			
M	TARNAVSKYI MAKSYM			U14 Kumite Male -50 kg			
M	Tenzhala Ivan			Junior Kumite Male 76+ kg			
M	Trofimov Daniil			Cadet Kumite Male -52 kg			
M	Tykhovetskyi Artem			U14 Kumite Male -50 kg			
M	Tyshchenko Danylo			Cadet Kumite Male 70+ kg			
M	Urumian Yurii			Cadet Kumite Male -70 kg			
UKR03053	UKR03053			M	USHAKOV YURIY	U21 Kumite Male 84+ kg	
				M	Ustiantsev Mark	U14 Kumite Male -50 kg	
				M	VASYLENKO VLADYSLAV	U14 Kumite Male -40 kg	
				M	Vedmid Illia	U14 Kumite Male -50 kg	
UKR03559	UKR03559			M	Verbitskyi Filip	U14 Kumite Male -45 kg	
				M	VIECHKANOV MAKSYM	Cadet Kumite Male -52 kg	
				M	VOITSIKHOVSKYU MYKOLA	Cadet Kumite Male -70 kg	
UKR2368	UKR2368			M	YANOVSKYI DAVYD	U21 Kumite Male -67 kg	
		M	Yatsko Kyryll	U14 Kumite Male -55 kg			
		M	Yemelianov Maksym	U14 Kata Male			
		M	Zhmurenko Ivan	U14 Kumite Male -40 kg			
		M	Zhyliuk Yehor	Cadet Kumite Male -70 kg			
		F	Anufrieva Rimma	U14 Kumite Female -42 kg			
		F	Astapova Darina	U14 Kumite Female -42 kg			
UKR03150	UKR03150	F	BARANOVA ULIANA	Junior Kata Female			



Karate1 Youth League - Venice 2024



ENTRIES BY NATIONAL FEDERATION

As of 8 DEC 2024

Country Code	ID	Gender	Name	Event	Seed
UKR	UKR03150	F	BARANOVA ULIANA	Junior Kumite Female -66 kg	
		F	Barykina Daryna	U21 Kumite Female -68 kg	
UKR	UKR02864	F	Bezbozhna Yelyzaveta	Junior Kumite Female -59 kg	
		F	Bulay Dariia	Junior Kumite Female 66+ kg	
		F	Bychenkova Polina	U14 Kumite Female -47 kg	
		F	Chuprina Arina	U14 Kumite Female -47 kg	
		F	Denysenko Aryna	U14 Kumite Female -47 kg	
		F	Derevianko Anastasiia	U14 Kumite Female 52+ kg	
		F	Filatova Veronika	U14 Kumite Female -47 kg	
UKR	UKR02682	F	Fohlinska Vira	U21 Kumite Female -68 kg	
UKR	UKR03054	F	GOLENIA SOFIA	Junior Kumite Female -66 kg	
F		Golod Anastasiia	Junior Kata Female		
UKR	UKR03014	F	Gryshchenko Daria	U14 Kumite Female -52 kg	
		F	HAIDUK YANA	U14 Kumite Female -42 kg	
		F	Hnativ Anastasiia	U14 Kumite Female -47 kg	
		F	Hnes Mariia	Junior Kumite Female -53 kg	
		F	Hontarenko Viktoriia	Cadet Kumite Female 61+ kg	
		F	Hryk-Vlasova Rehina	U14 Kumite Female -52 kg	
		F	Hudym Veronika	Junior Kumite Female -48 kg	
		F	KHOLOD YEVA	U14 Kumite Female -42 kg	
		F	KHOLODNIAK DARIA	Junior Kata Female	
		F	Koliada Marharyta	U14 Kumite Female -42 kg	
		F	KOLOBANOVA SVITLANA	U14 Kumite Female -52 kg	
		F	Kolomiichuk Anastasiia	Cadet Kata Female	
		F	Kondratiuk Marharyta	Cadet Kumite Female -47 kg	
		F	Konstantynova Daria	Cadet Kumite Female -47 kg	
		F	Koshel Sofiya	Junior Kumite Female -59 kg	
		F	Kossak Adriana	Cadet Kumite Female 61+ kg	
		F	Kossak Roksolana	U14 Kumite Female -47 kg	
F	Kozylilian Nataliia	Cadet Kumite Female -47 kg			
F	Krapivna Anastasiia	U14 Kumite Female -42 kg			
UKR	UKR02915	F	Krot Yuliiia	U21 Kumite Female 68+ kg	
SD	SD66473	F	KRUHLOVA SHARLIZ	U14 Kumite Female -52 kg	
		F	Kruhlyk Yelyzaveta	Cadet Kumite Female -47 kg	
		F	Ksondz Amieliia	U14 Kumite Female 52+ kg	
		F	Kurash Veronika	Cadet Kumite Female -47 kg	
		F	KYRYCHENKO KATERYNA	Junior Kumite Female -53 kg	
		F	Lysytska Nadiia	Junior Kumite Female -66 kg	
		F	Maistrenko Hanna	Cadet Kumite Female -47 kg	
		F	Makarenko Violetta	Junior Kumite Female -59 kg	
		F	Malikova Karolina	U14 Kumite Female 52+ kg	
		F	Malko Nadiia	U14 Kumite Female 52+ kg	
		F	Mamalyha Marichka	U14 Kumite Female 52+ kg	
		F	Marchenko Yeva	Junior Kumite Female -53 kg	
		F	Mashyra Sofiia	U14 Kumite Female -52 kg	
		F	Mezentseva Kateryna	U14 Kumite Female -47 kg	
		F	Mollaieva Mariam	U14 Kumite Female -52 kg	
		F	Mudzhuk Alona	Junior Kumite Female -59 kg	



Karate1 Youth League - Venice 2024



ENTRIES BY NATIONAL FEDERATION

As of 8 DEC 2024

Country Code	ID	Gender	Name	Event	Seed
UKR		F	Muravska Yelyzaveta	U14 Kumite Female -47 kg	
		F	Nabok YEVA	U14 Kumite Female 52+ kg	
		F	Orlova Vladyslava	Cadet Kumite Female -47 kg	
		F	OSTAPENKO ALISA	Cadet Kumite Female -47 kg	
		F	Pirkovets Mariia	U14 Kumite Female -52 kg	
		F	POPOVA DIANA	U14 Kumite Female 52+ kg	
		F	PRYNDIUK ANASTASIIA	U14 Kumite Female -42 kg	
		F	Pushkova Anastasiia	Junior Kumite Female -59 kg	
		F	Pylypiuk Daria	U21 Kumite Female -50 kg	
		F	Revunova Mariia	U14 Kumite Female -47 kg	
		F	Rudnikova Anastasiia	U14 Kumite Female 52+ kg	
	UKR03084	F	RUSAN HANNA	Junior Kumite Female -66 kg	
	UKR02524	F	Rusu Yuliia	U21 Kumite Female 68+ kg	
		F	Salnyk Anita	U14 Kumite Female -47 kg	
		F	SEMENIUK SOFIIA	Cadet Kumite Female -47 kg	
		F	Shapovalova Mariia	U14 Kumite Female -47 kg	
		F	Sheptiy Polina	U14 Kumite Female 52+ kg	
		F	SHEVCHENKO KARYNA	U14 Kumite Female -52 kg	
		F	Sibova Daria	Junior Kumite Female -53 kg	
		F	Skibchyk Kira	Cadet Kumite Female -47 kg	
		F	SOTNIKOVA IVANNA	U14 Kumite Female -47 kg	
		F	STANOVSKA VERONIKA	Cadet Kumite Female -47 kg	
		F	SVENTYTSKA VERONIKA	Cadet Kumite Female 61+ kg	
		F	Sydorska Marharyta	Cadet Kumite Female -54 kg	
	SD66568	F	Tahirova Maria	Cadet Kumite Female 61+ kg	
		F	Toderash Oleksandra	Cadet Kumite Female -61 kg	
		F	Trandasir AppolinariiA	U14 Kumite Female 52+ kg	
		F	Turanska Anastasiia	Cadet Kumite Female -47 kg	
		F	Tyshyna Veronika	Cadet Kumite Female -47 kg	
		F	Uhnich Sofiia	Cadet Kumite Female -47 kg	
	UKR02851	F	Vashchyshyn Anna	Junior Kumite Female -53 kg	
		F	Vasyliv Tatyana	Junior Kumite Female -66 kg	
		F	VERBYNENKO KATERYNA	Cadet Kata Female	
		F	Voloshyn Solomiia	Junior Kumite Female -66 kg	
		F	Vynohradova Olha	Junior Kata Female	
		F	Zlatova Uliana	Cadet Kumite Female -47 kg	
USA		M	Bonetti Akiau Luigi	U14 Kata Male	
	USA02983	M	Cruz Kevin	U21 Kumite Male -60 kg	
	USA03698	M	Daswani Samuel	U21 Kumite Male -75 kg	
		M	Davila Martin	Cadet Kata Male	
		M	Davila Martin	Cadet Kumite Male -70 kg	
		M	Dolinyan Davit	U21 Kumite Male -60 kg	
	USA02988	M	Farris Logan	Cadet Kumite Male -63 kg	
	USA02982	M	Isa Cheon	Junior Kata Male	
		M	Jackson Isaiah	Cadet Kumite Male 70+ kg	
		M	Levin Alexander	U14 Kumite Male -40 kg	
		M	Mujat Doru	Cadet Kumite Male 70+ kg	



Karate1 Youth League - Venice 2024



ENTRIES BY NATIONAL FEDERATION

As of 8 DEC 2024

Country Code	ID	Gender	Name	Event	Seed	
USA	USA02996	M	Ochoa Ken	Junior Kumite Male -55 kg		
		F	Allen Presley	U14 Kumite Female -47 kg		
		F	Arcalean Mihaela	U14 Kumite Female -52 kg		
		F	Cottingham Emmersyn	Junior Kata Female		
		F	Grzegorzewski Dayana	Junior Kata Female		
		F	Rashidi Lily	U14 Kata Female		
		VEN	VEN2323	M	BELISARIO GONZÁLEZ CARLOS EDUARDO	U21 Kumite Male -84 kg
M	GASCON GUTIERREZ AARON MOISES			Cadet Kumite Male -63 kg		
VEN02631	M		GRECO GIANLUCA	Junior Kata Male		
	M		Henriquez Manuel	U14 Kumite Male -55 kg		
VEN003082	M		IGNACIO RIOS	Cadet Kumite Male -63 kg		
	M		Leon Soto Lezker David	Junior Kumite Male 76+ kg		
	M		LUCAS MUJICA TOMAS	Cadet Kumite Male -63 kg		
	M		Milla Berti Alfonso David	Junior Kumite Male -55 kg		
	M		Muga Shamuel	U14 Kata Male		
	M		Pinto Diego	U14 Kumite Male -40 kg		
	M		QUINTANA QUIJADA ENZO EDUARDO	Cadet Kata Male		
	VEN003130		M	Ruz Luis	Cadet Kata Male	
VEN003130	M		Ruz Luis	Cadet Kumite Male -70 kg		
VEN003081	M		SEBASTIAN RODRIGUEZ	U21 Kumite Male -67 kg		
	M		Sulbaran González Jesus Daniel	Junior Kumite Male -55 kg		
	M		TORRES FIGUEROA JUAN ALFONSO	U14 Kata Male		
	VEN02381		M	Vivas JUAN DIEDO	U21 Kumite Male -75 kg	
			F	Angel Cote Deilimar Gabriela	U14 Kumite Female 52+ kg	
F			GÓMEZ DUGARTE ARIANNA MAIBETH	Junior Kumite Female -48 kg		
F			Loyo Montero Katherine	Junior Kumite Female -48 kg		
F			TORO KATHERINE	Junior Kumite Female -48 kg		
WAL			M	Lewis Caian	U14 Kata Male	
			F	Lewis Chloe	Junior Kata Female	
		F	Williams Niah	Cadet Kata Female		



Karate1 Youth League - Venice 2024



Statistics

Participating Countries: 79

	Competitors	Entries
Female	1660	1682
Male	2003	2034
Total	3663	3716

Entries per Category	Entries	Teams
Cadet Kata Female	117	-
Cadet Kata Male	118	-
Cadet Kumite Female -47 kg	86	-
Cadet Kumite Female -54 kg	91	-
Cadet Kumite Female -61 kg	89	-
Cadet Kumite Female 61+ kg	88	-
Cadet Kumite Male -52 kg	95	-
Cadet Kumite Male -57 kg	92	-
Cadet Kumite Male -63 kg	90	-
Cadet Kumite Male -70 kg	83	-
Cadet Kumite Male 70+ kg	78	-
Junior Kata Female	116	-
Junior Kata Male	107	-
Junior Kumite Female -48 kg	63	-
Junior Kumite Female -53 kg	83	-
Junior Kumite Female -59 kg	89	-
Junior Kumite Female -66 kg	83	-
Junior Kumite Female 66+ kg	50	-
Junior Kumite Male -55 kg	74	-
Junior Kumite Male -61 kg	90	-
Junior Kumite Male -68 kg	92	-
Junior Kumite Male -76 kg	87	-
Junior Kumite Male 76+ kg	90	-
U14 Kata Female	86	-
U14 Kata Male	81	-
U14 Kumite Female -42 kg	78	-
U14 Kumite Female -47 kg	82	-
U14 Kumite Female -52 kg	81	-
U14 Kumite Female 52+ kg	90	-
U14 Kumite Male +55 kg	89	-
U14 Kumite Male -40 kg	93	-



Karate1 Youth League - Venice 2024



Statistics

U14 Kumite Male -45 kg	88	-
U14 Kumite Male -50 kg	86	-
U14 Kumite Male -55 kg	80	-
U21 Kata Female	85	-
U21 Kata Male	88	-
U21 Kumite Female -50 kg	43	-
U21 Kumite Female -55 kg	42	-
U21 Kumite Female -61 kg	55	-
U21 Kumite Female -68 kg	48	-
U21 Kumite Female 68+ kg	37	-
U21 Kumite Male -60 kg	73	-
U21 Kumite Male -67 kg	82	-
U21 Kumite Male -75 kg	88	-
U21 Kumite Male -84 kg	50	-
U21 Kumite Male 84+ kg	40	-
Totals:	3716	0

CADET KATA FEMALE



Karate1 Youth League - Venice 2024

ENTRIES BY WEIGHT CATEGORY



Cadet Kata Female

As of 8 DEC 2024

Country Code	ID	Gender	Name	Seeding
AND	AND2154	F	BEAL BARROS SARA	
AND	AND2153	F	UBIERGO ALAMAN MARIA	
AUT	AUT02674	F	LEHNER TAMARA	
BIH		F	Mehanović Berina	
CAN		F	Song Dora	
CRO	CRO04211	F	BADJUN ANA	
CRO		F	Gudelj Lara	
CRO		F	Lacković Lucija	
CZE	CZE02437	F	POHLOVA EDITA	
DEN		F	Emde Sara	
EGY	EGY04133	F	AHMED FAYRUZ	
ENG		F	Baker Aimee	
ENG		F	Brewin Erin	
ENG		F	Kidd Janelle	
ENG		F	Nurse Ava	
ENG		F	Wegrzyn Nada	
ESP		F	Benedicto Acosta Ariadna	
ESP		F	Castro López Rocío	
ESP		F	COMELLA NEVADO CATERINA	
ESP		F	RÍO CARAVANTES JÚLIA	
ESP		F	RODRÍGUEZ MARTÍNEZ ARIADNA	
ESP		F	SIGÜENZA CRUCES SANDRA	
FIN		F	Wanic Marie	
FRA		F	BOUDEUF HANNA	
FRA		F	EVESQUE LORIANE	
FRA		F	LEFEBVRE VELLA MELODIE	
FRA		F	Nakano Lea	
FRA		F	PIAZZA D OLMO Maryon	
FRA	SD63771	F	Vilanova Julia	
FRA	SD67353	F	VORATOVIC Iliana	
FRA		F	Yapoby Camerone	
GER		F	Aßmann Linnea	
GER	GER003877	F	BAGHDJIAN DANA	
GER		F	Biedemann Greta	
GER		F	Biedemann Hannah	
GER	GER03796	F	DREWES LEYLA	
GER		F	Ehling Magdalena	
GER	GER004012	F	GOETHE MARIEL	
GER		F	Gruber Daria	
GER		F	Iskandaryan Anne-Marie	
GER		F	Kollmann Mara Luise	
GER		F	Längerer Laetizia	
GER		F	Längerer Stella	
GER		F	Libik Tamara	
GER		F	Seiler Laura Sophie	



Karate1 Youth League - Venice 2024

ENTRIES BY WEIGHT CATEGORY



Cadet Kata Female

As of 8 DEC 2024

Country Code	ID	Gender	Name	Seeding
GER		F	Wienbeck Rani	
HUN		F	Bacsó Kata	
HUN		F	Benkő Szonja Lola	
HUN		F	Szatomáry Karolina	
ITA		F	AUDIA ASIA	
ITA		F	Cardaropoli Isabel	
ITA		F	Crucitti Sofia	
ITA		F	Dellamico Gioia	
ITA	SD749997	F	De Pace Maria Luisa	
ITA	SD739449	F	Dublino Beatrice	
ITA		F	ESPOSITO Emilia	
ITA	ITA-534805	F	FERRATO ALESSIA	
ITA		F	FRIGENI MICHELA	
ITA		F	Gargiulo Terry	
ITA		F	LENZONI EMMA	
ITA		F	Naglein Emma	
ITA		F	Natalini Giulia Ginevra	
ITA	SD57222	F	Oberto Vivien	
ITA		F	Pignatti Giulia	
ITA		F	RICCIARDI ANGELA	
ITA		F	Russo Emilie	
ITA		F	STAGI NICOLE	
ITA		F	VALENTI JENNIFER	
ITA		F	Viacava Camilla	
JPN		F	ASATO COCORO	
JPN		F	BANNO RINO	
JPN		F	Hori Ria	
LUX		F	Breisch Anna	
LUX		F	Breser Anastasia	
LUX		F	Johanns Camille	
LUX		F	Mostefa-sba Sarah	
MLT	MLT02238	F	AWAD ATTIA JENNA	
MNE	MNE0049239	F	Beljkas Neda	
NED		F	Laassal Loubna	
POL		F	Bachorz Lori	
POL	POL09532	F	KASZYNSKA ALICJA	
POL	POL06845	F	KNYZIAK ZOFIA	
POL	POL2566	F	Toś Aleksandra	
POL	POL2858	F	ZUREK MILENA	
POR	POR03183	F	BAZYUK VICTORIA	
POR		F	Brandauer Chiara	
POR		F	Guiomar Salomé	
POR		F	Martins Joana	
POR		F	Meco Alice	
POR		F	Pereira Maria Leonor	



Karate1 Youth League - Venice 2024

ENTRIES BY WEIGHT CATEGORY



Cadet Kata Female

As of 8 DEC 2024

Country Code	ID	Gender	Name	Seeding
ROU	ROU03577	F	ASABI TIMEEA GAGEA	
ROU	ROU03729	F	DUMITRASCU COSMINA	
ROU	ROU003970	F	ELENA DIANA GHEORGHE	
ROU	ROU2448	F	MARIA SIMION	
ROU	ROU03728	F	OANCEA MELANIA	
SLO	SLO02701	F	BRACUN MASERA IRIS	
SLO	SLO02940	F	KRAMAR LILI	
SLO	SLO02719	F	MAVSAR TAJDA	
SRB		F	Laušević Daša	
SRB		F	Ljukovčanin Nađa	
SRB		F	Malbašić Helena	
SRB		F	Muric Miona	
SRB		F	Nikić Jana	
SRB		F	Perović Anđela	
SUI		F	Campell Larissa	
SUI		F	Michaud Zoé	
SUI	SUI03111	F	Özdemir Demet	
SUI	SUI02739	F	Ritz Maia	
SUI	SUI003225	F	Schedel Kaena	
SVK	SD60750	F	KIŠŠKOVÁ KAROLÍNA	
SVK		F	Smatanová Ema	
SVK		F	WENDERLOVA MIRIAM	
SWE		F	Karlsson Leila	
SWE		F	Vapper Minou	
UKR		F	Kolomiichuk Anastasiia	
UKR		F	VERBYNENKO KATERYNA	
WAL		F	Williams Niah	

Cadet Kata Female

Karate1 Youth League - Venice 2024, PALAZZO DEL TURISMO, Piazza Brescia 11, 30016 Lido di Jesolo VE, ITA

2024-12-06

Tatami

1 09:00

Pool

1/8

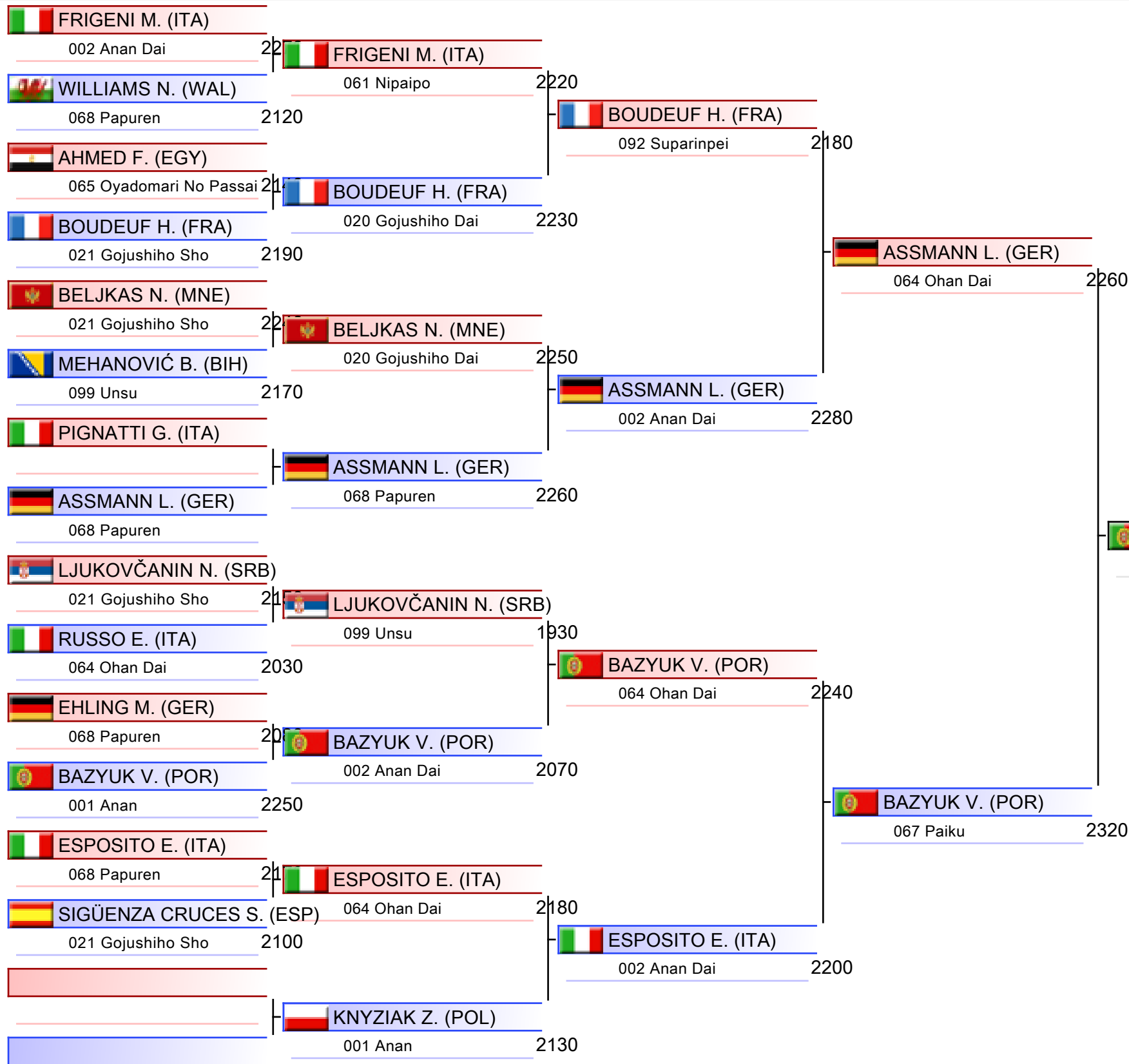

1. HORI RIA (JPN)
2. LEHNER TAMARA (AUT)
3. BENKŐ SZONJA LOLA (HUN)
3. CASTRO LÓPEZ ROCÍO (ESP)
5. DUBLINO BEATRICE (ITA)
5. NAGLEIN EMMA (ITA)
7. LIBIK TAMARA (GER)
7. ASATO COCORO (JPN)

Cadet Kata Female

Karate1 Youth League - Venice 2024, PALAZZO DEL TURISMO, Piazza Brescia 11, 30016 Lido di Jesolo VE, ITA

2024-12-06

Tatami
2 09:00

Pool
2/8

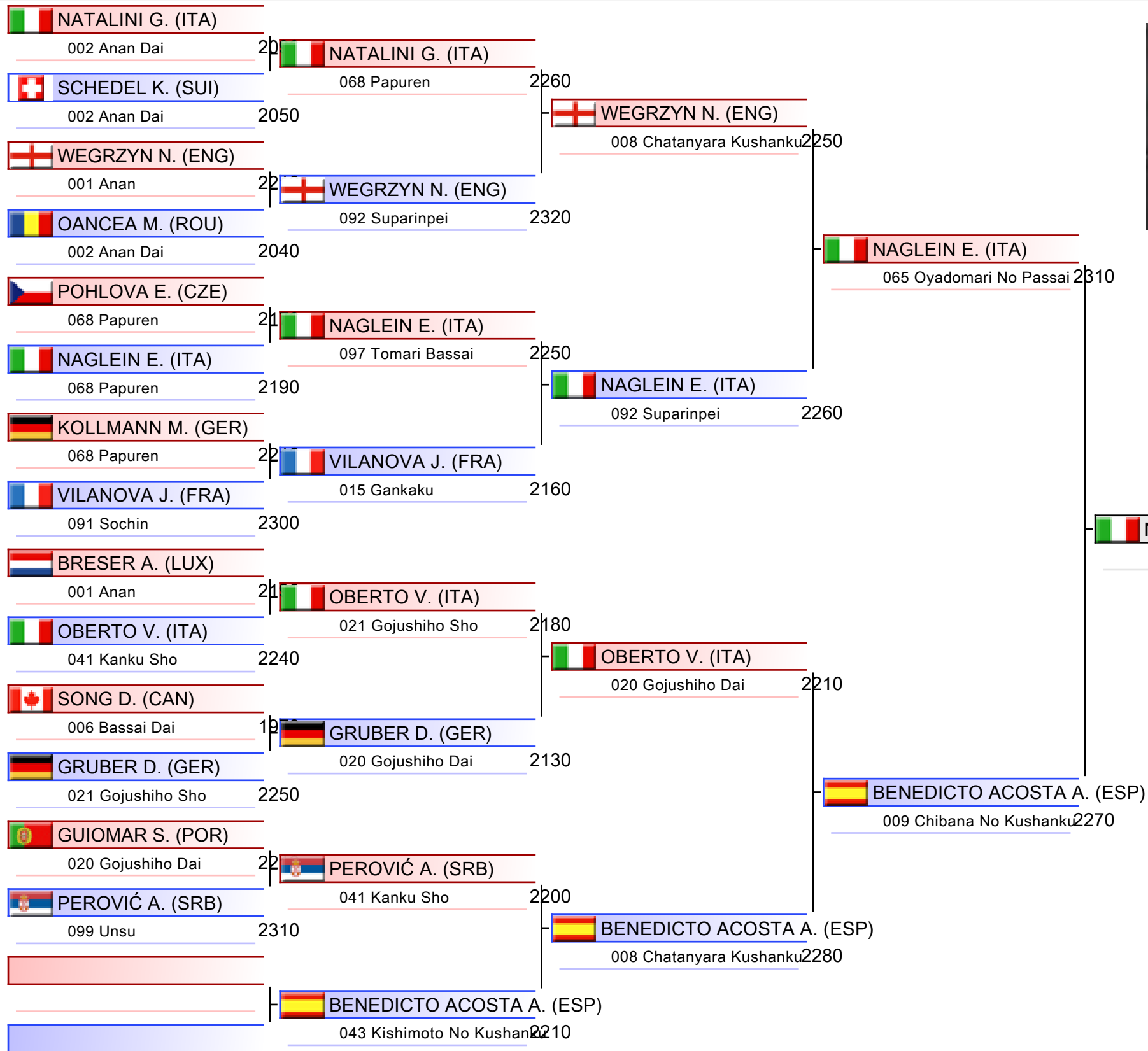

1. HORI RIA (JPN)
2. LEHNER TAMARA (AUT)
3. BENKŐ SZONJA LOLA (HUN)
3. CASTRO LÓPEZ ROCÍO (ESP)
5. DUBLINO BEATRICE (ITA)
5. NAGLEIN EMMA (ITA)
7. LIBIK TAMARA (GER)
7. ASATO COCORO (JPN)

Cadet Kata Female

Karate1 Youth League - Venice 2024, PALAZZO DEL TURISMO, Piazza Brescia 11, 30016 Lido di Jesolo VE, ITA

2024-12-06

Tatami
3 09:00

Pool
3/8

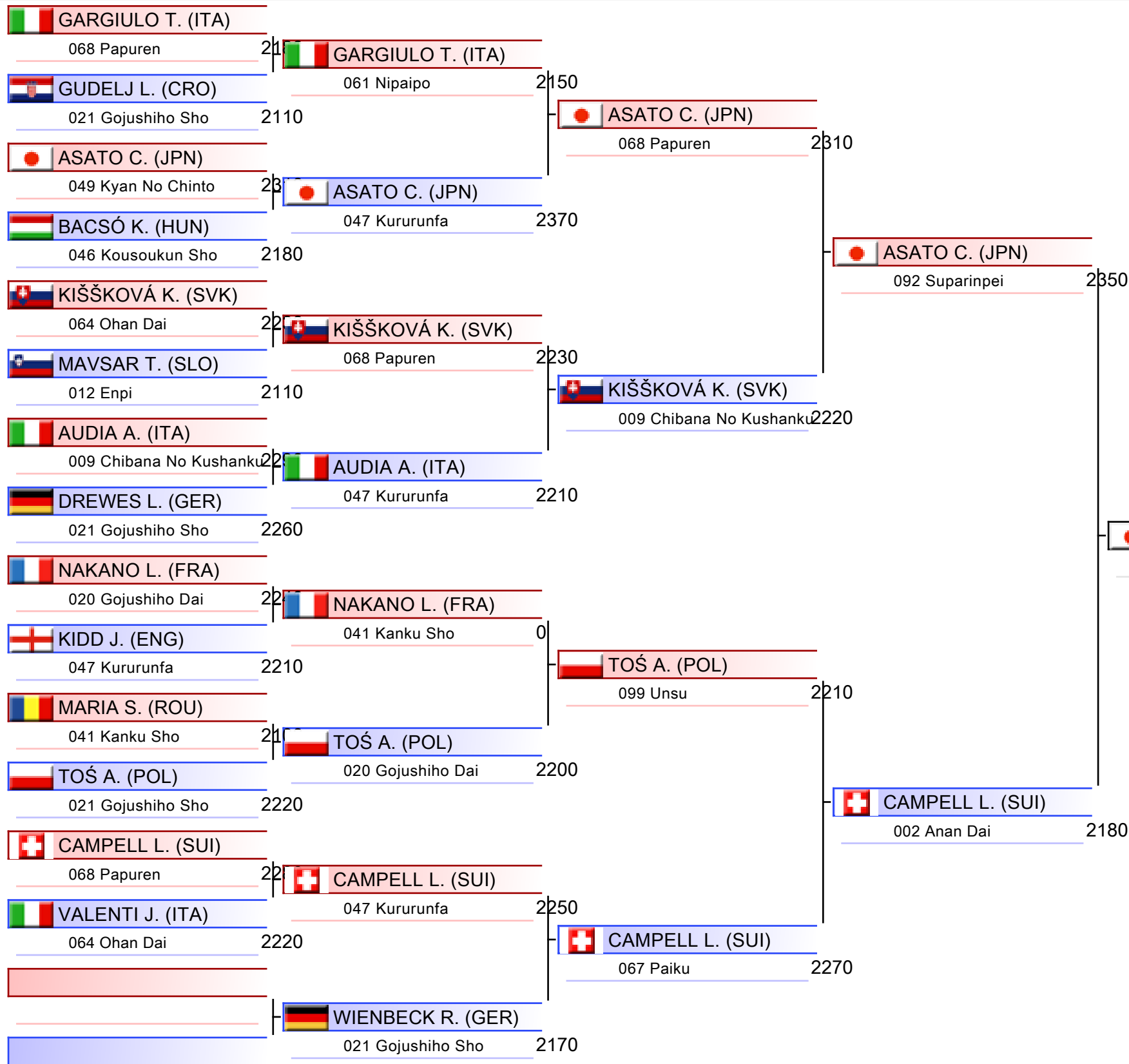

1. HORI RIA (JPN)
2. LEHNER TAMARA (AUT)
3. BENKŐ SZONJA LOLA (HUN)
3. CASTRO LÓPEZ ROCÍO (ESP)
5. DUBLINO BEATRICE (ITA)
5. NAGLEIN EMMA (ITA)
7. LIBIK TAMARA (GER)
7. ASATO COCORO (JPN)

Cadet Kata Female

Karate1 Youth League - Venice 2024, PALAZZO DEL TURISMO, Piazza Brescia 11, 30016 Lido di Jesolo VE, ITA

2024-12-06

Tatami
4 09:00

Pool
4/8

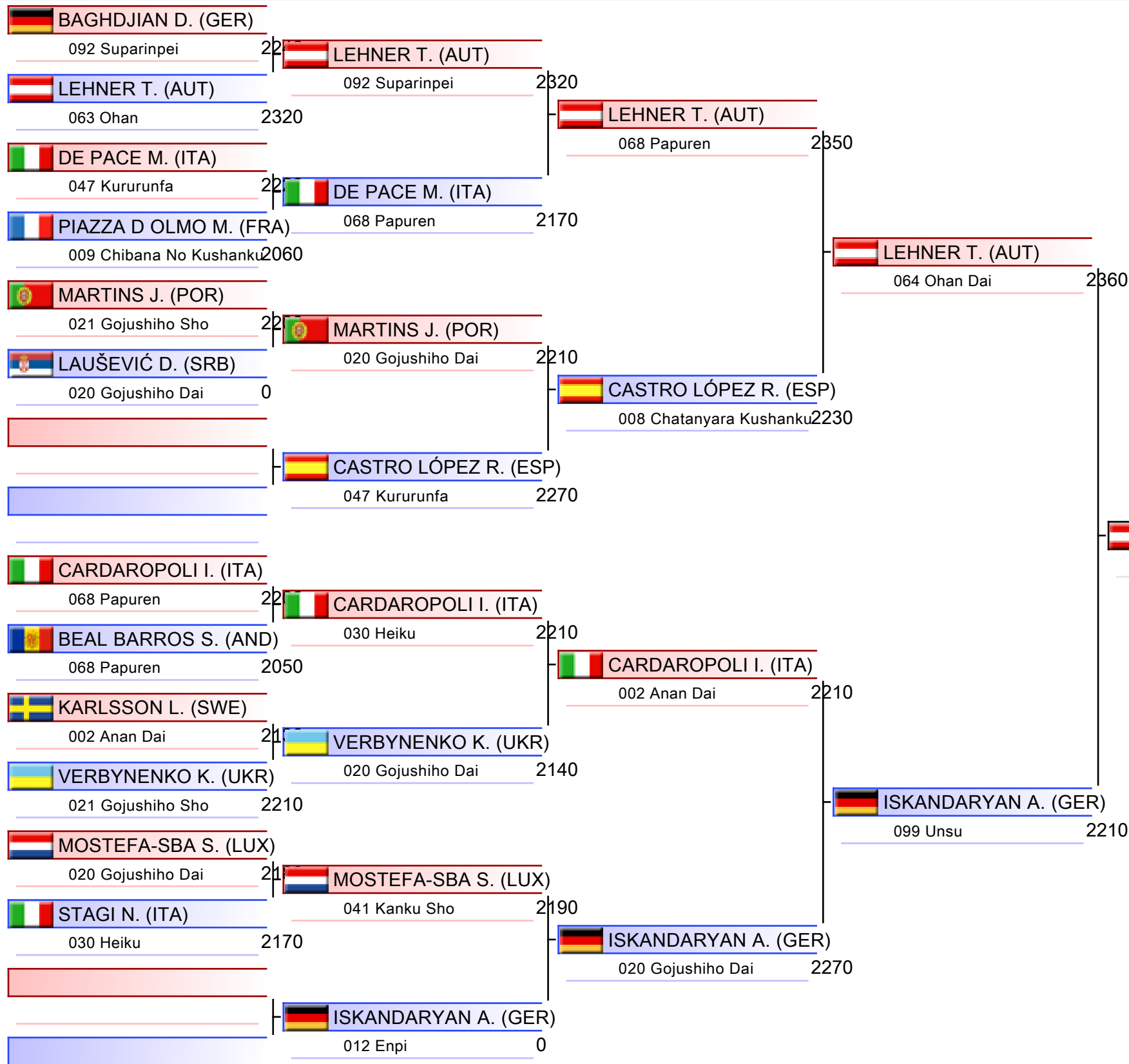

1. HORI RIA (JPN)
2. LEHNER TAMARA (AUT)
3. BENKŐ SZONJA LOLA (HUN)
3. CASTRO LÓPEZ ROCÍO (ESP)
5. DUBLINO BEATRICE (ITA)
5. NAGLEIN EMMA (ITA)
7. LIBIK TAMARA (GER)
7. ASATO COCORO (JPN)

Cadet Kata Female

Karate1 Youth League - Venice 2024, PALAZZO DEL TURISMO, Piazza Brescia 11, 30016 Lido di Jesolo VE, ITA

2024-12-06

Tatami
5 09:00

Pool
5/8

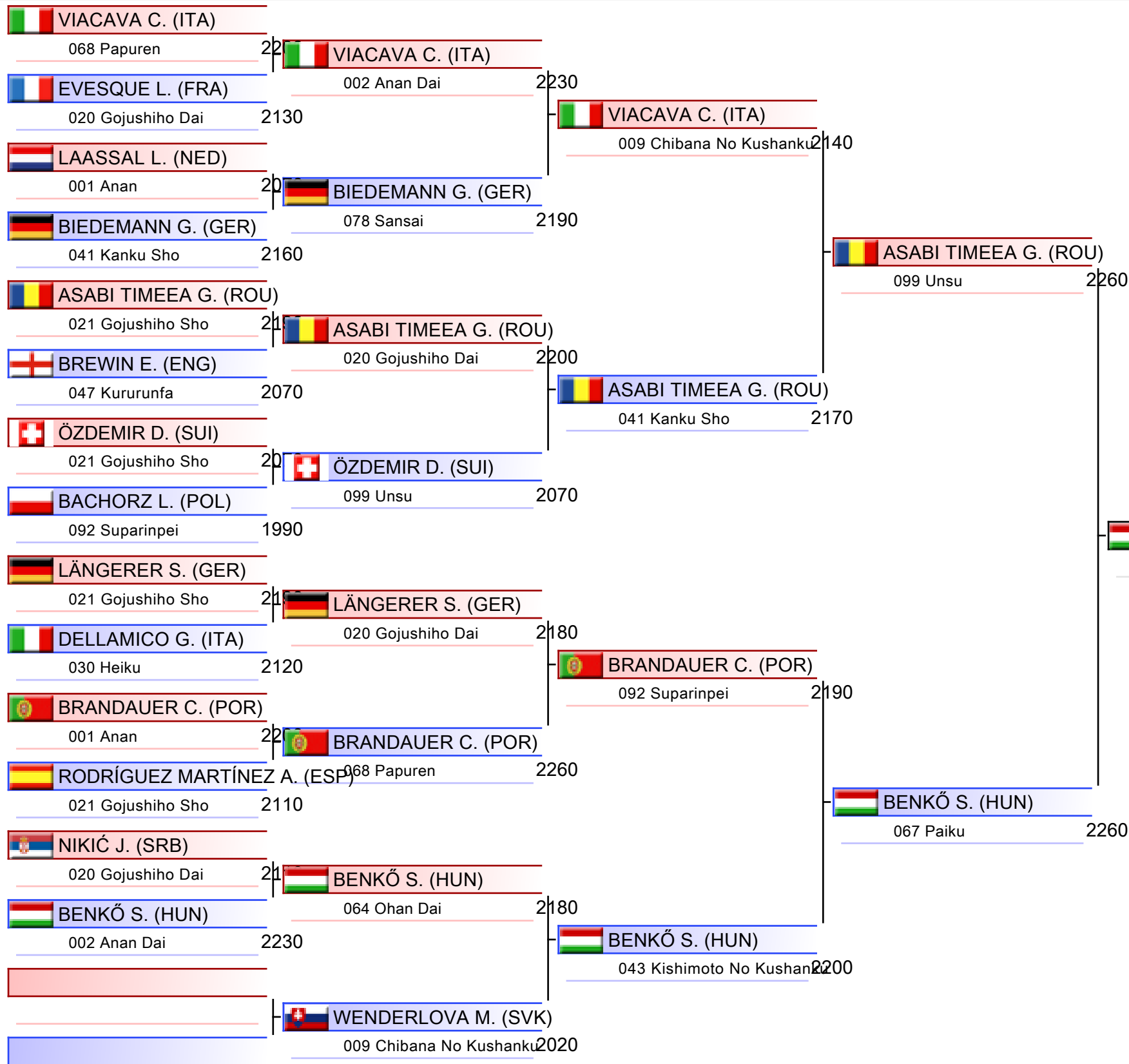

1. HORI RIA (JPN)
2. LEHNER TAMARA (AUT)
3. BENKŐ SZONJA LOLA (HUN)
3. CASTRO LÓPEZ ROCÍO (ESP)
5. DUBLINO BEATRICE (ITA)
5. NAGLEIN EMMA (ITA)
7. LIBIK TAMARA (GER)
7. ASATO COCORO (JPN)

Cadet Kata Female

Karate1 Youth League - Venice 2024, PALAZZO DEL TURISMO, Piazza Brescia 11, 30016 Lido di Jesolo VE, ITA

2024-12-06

Tatami
6 09:00

Pool
6/8

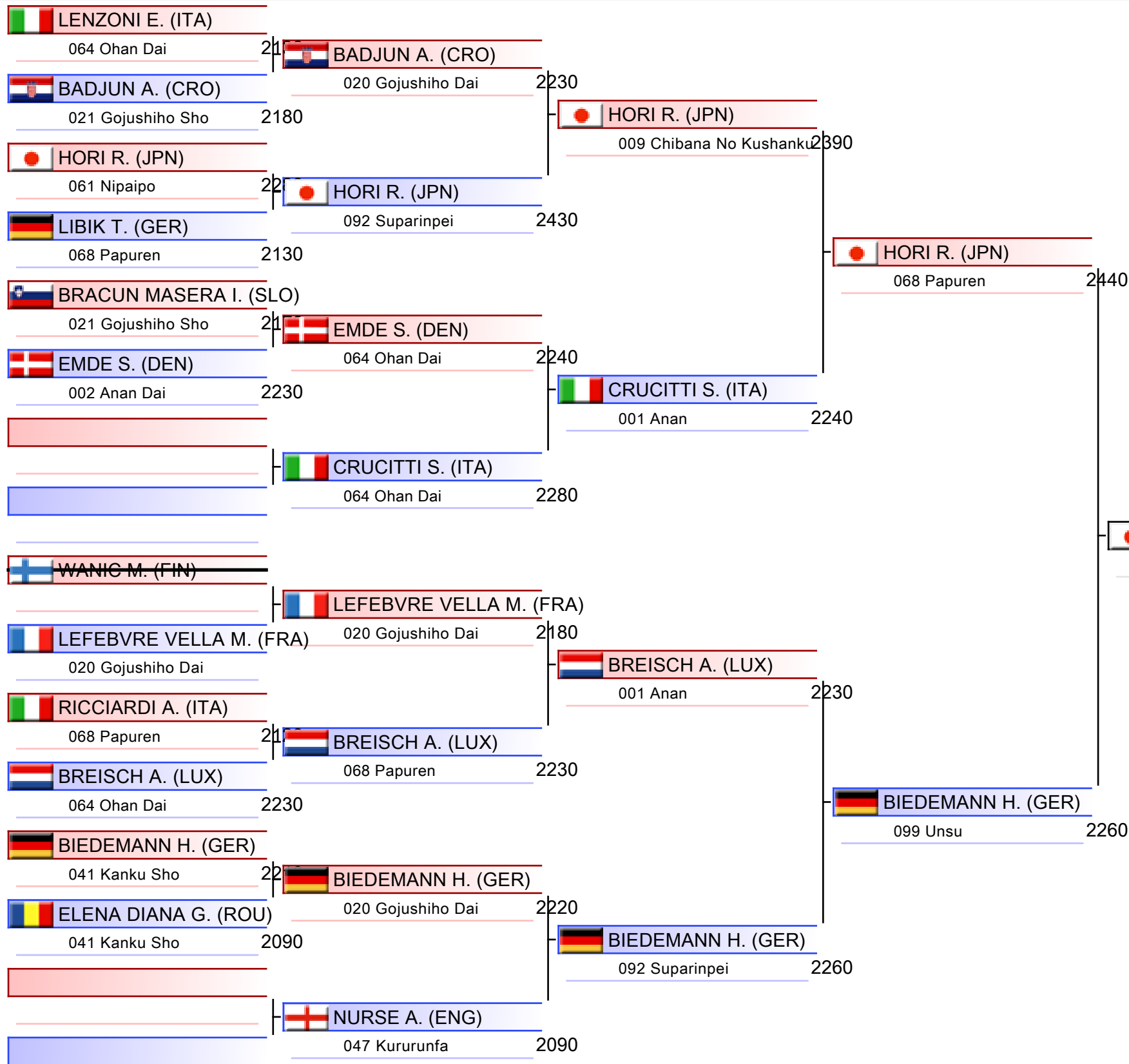

1. HORI RIA (JPN)
2. LEHNER TAMARA (AUT)
3. BENKŐ SZONJA LOLA (HUN)
3. CASTRO LÓPEZ ROCÍO (ESP)
5. DUBLINO BEATRICE (ITA)
5. NAGLEIN EMMA (ITA)
7. LIBIK TAMARA (GER)
7. ASATO COCORO (JPN)

Cadet Kata Female

Karate1 Youth League - Venice 2024, PALAZZO DEL TURISMO, Piazza Brescia 11, 30016 Lido di Jesolo VE, ITA

2024-12-06

Tatami
7 09:00

Pool
7/8

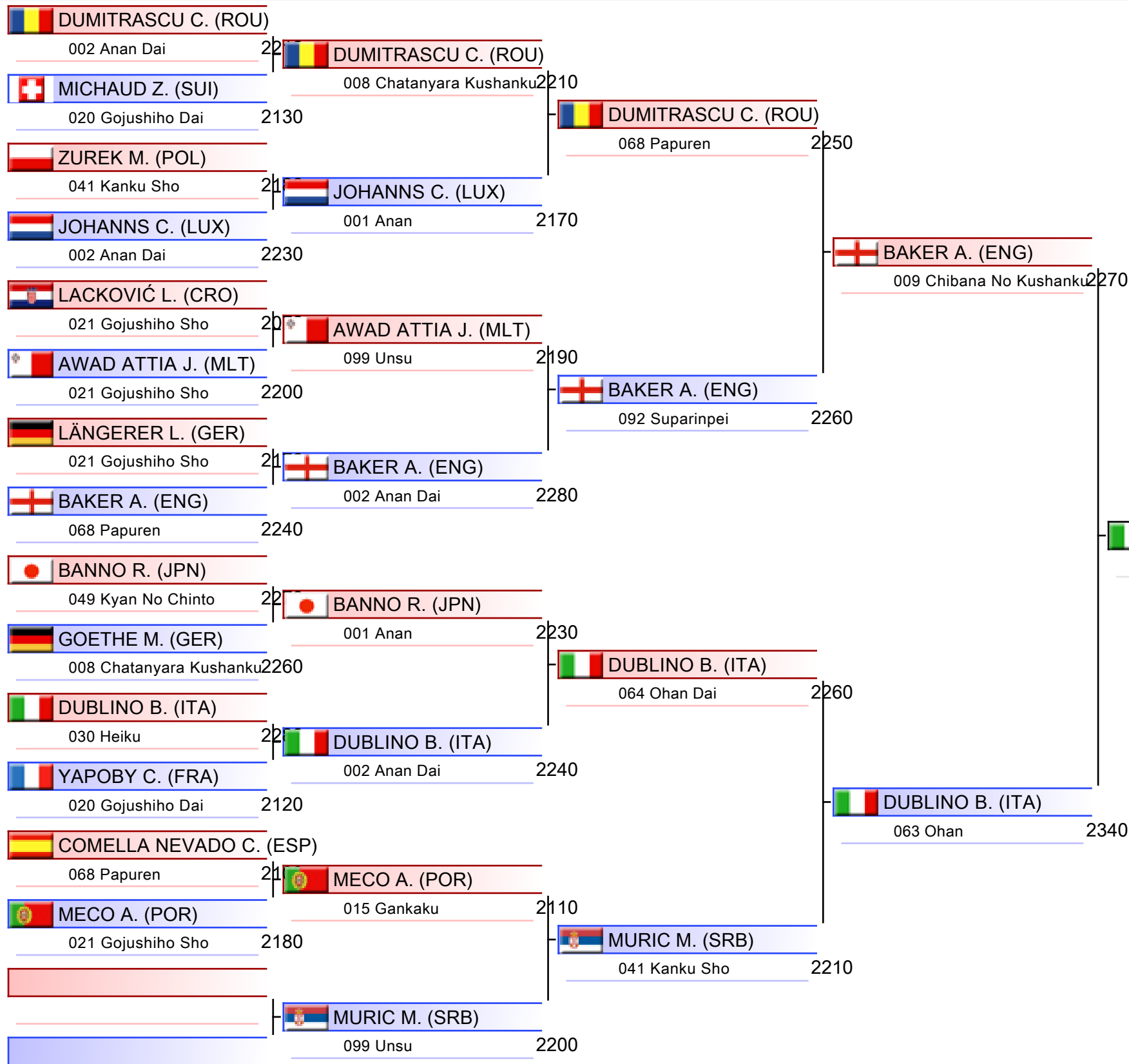

1. HORI RIA (JPN)
2. LEHNER TAMARA (AUT)
3. BENKŐ SZONJA LOLA (HUN)
3. CASTRO LÓPEZ ROCÍO (ESP)
5. DUBLINO BEATRICE (ITA)
5. NAGLEIN EMMA (ITA)
7. LIBIK TAMARA (GER)
7. ASATO COCORO (JPN)

Cadet Kata Female

Karate1 Youth League - Venice 2024, PALAZZO DEL TURISMO, Piazza Brescia 11, 30016 Lido di Jesolo VE, ITA

2024-12-06

Tatami
8 09:00

Pool
8/8

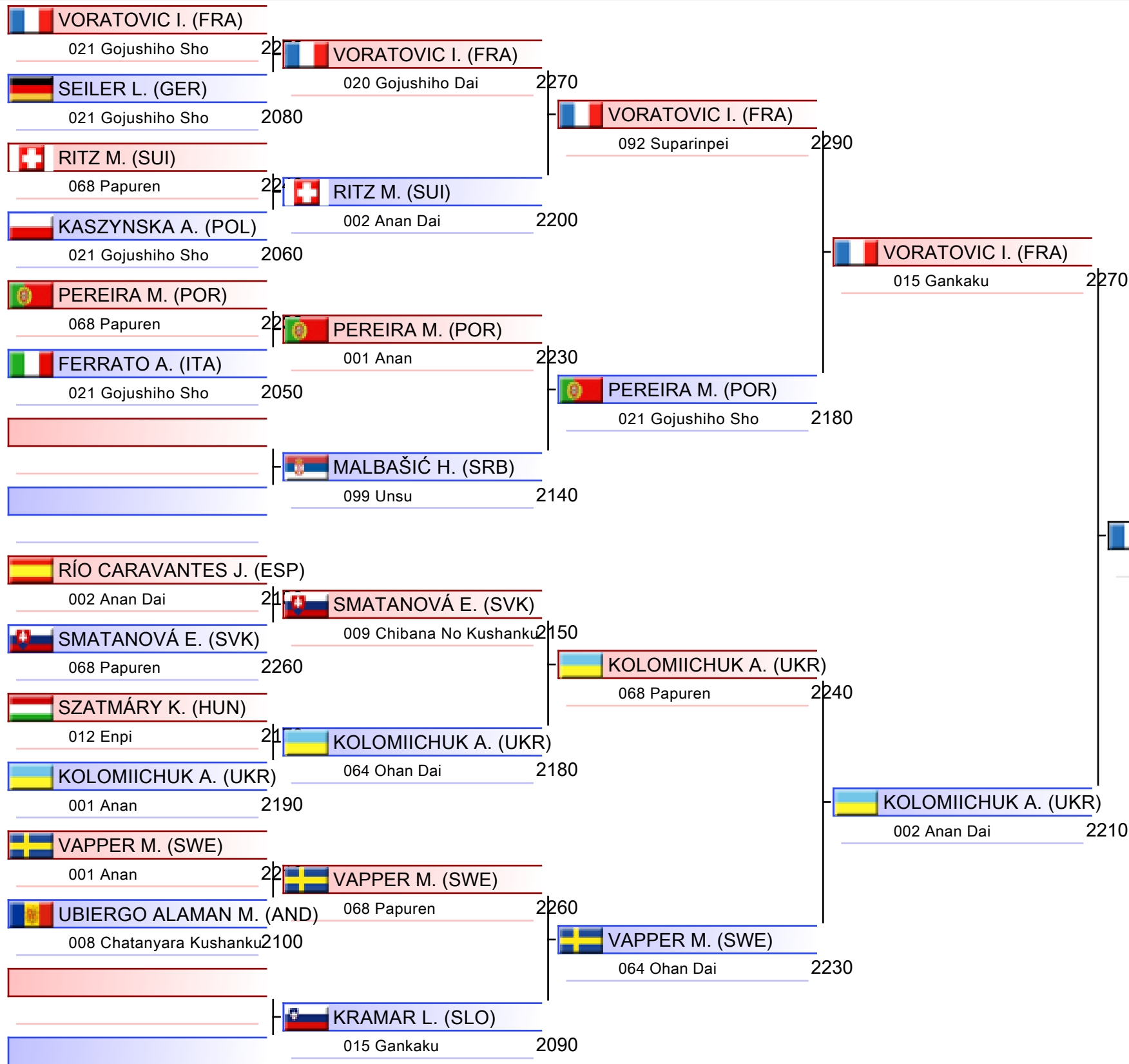

1. HORI RIA (JPN)
2. LEHNER TAMARA (AUT)
3. BENKŐ SZONJA LOLA (HUN)
3. CASTRO LÓPEZ ROCÍO (ESP)
5. DUBLINO BEATRICE (ITA)
5. NAGLEIN EMMA (ITA)
7. LIBIK TAMARA (GER)
7. ASATO COCORO (JPN)

Pool winner-Cadet Kata Female

Karate1 Youth League - Venice 2024, PALAZZO DEL TURISMO, Piazza Brescia 11, 30016 Lido di Jesolo VE, ITA

2024-12-06

Tatami
1 10:40

Pool
1/1

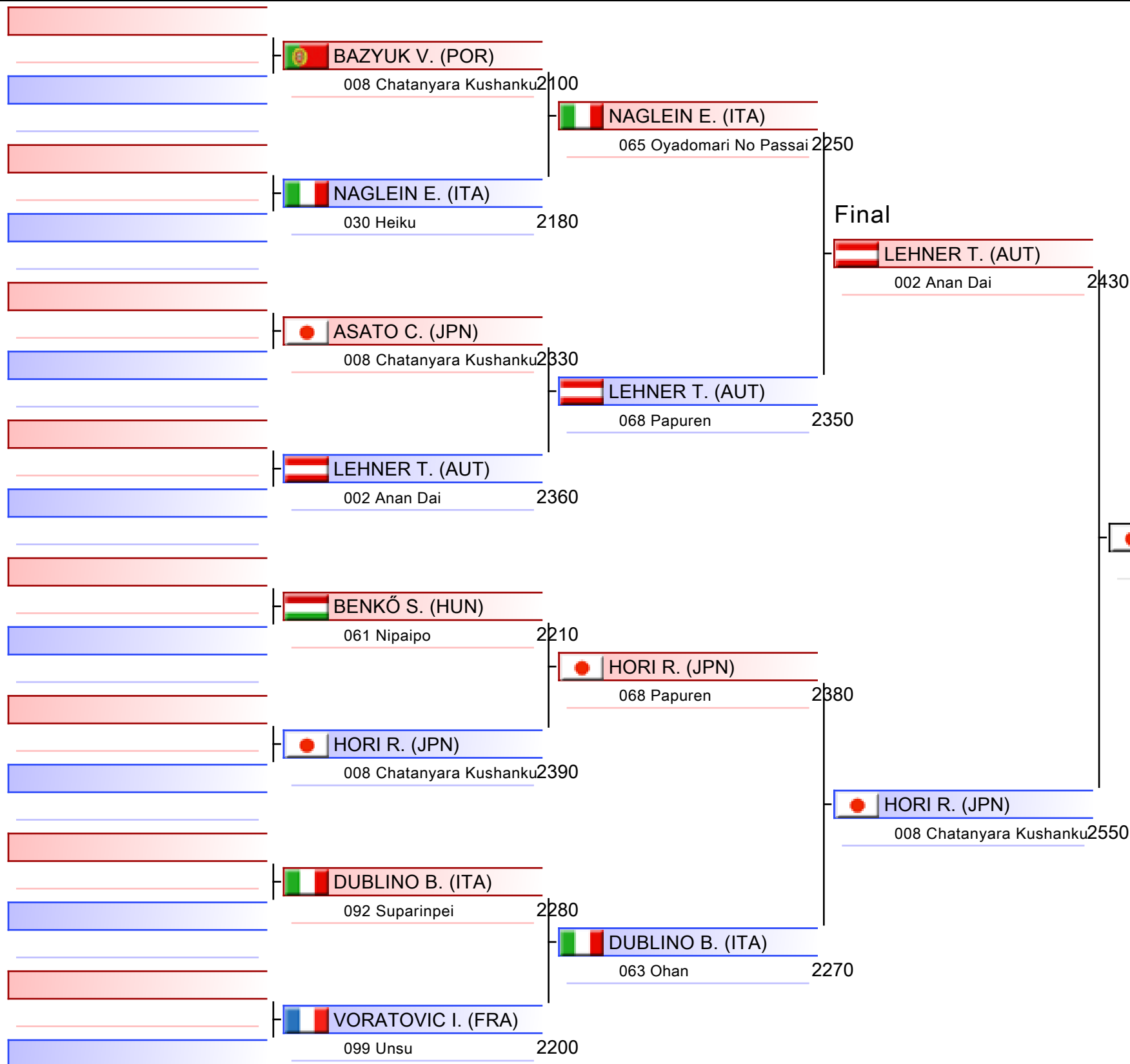

1. HORI RIA (JPN)
2. LEHNER TAMARA (AUT)
3. BENKŐ SZONJA LOLA (HUN)
3. CASTRO LÓPEZ ROCÍO (ESP)
5. DUBLINO BEATRICE (ITA)
5. NAGLEIN EMMA (ITA)
7. LIBIK TAMARA (GER)
7. ASATO COCORO (JPN)

Cadet Kata Female

Karate1 Youth League - Venice 2024

2024-12-06

Tatami

3 13:10

Pool

1,2,3,4

(c)sportdata GmbH & Co KG 2000-2024 (2024-12-08 20:16) v 10.2.0 build 1 (2024-11-20 00:58 CET) License: SDIL TVG (expire 2025-01-26)

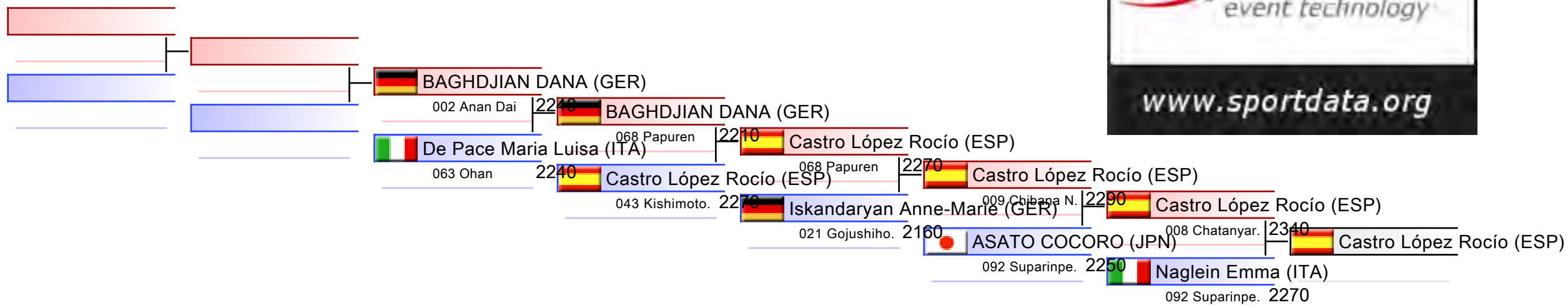

REPECHAGE: (1,2,3,4)

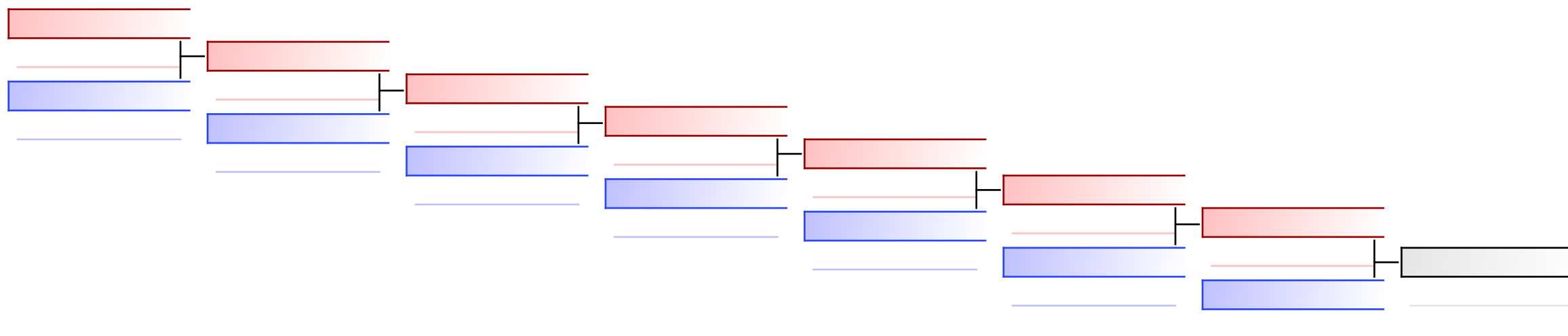

Cadet Kata Female

Karate1 Youth League - Venice 2024

2024-12-06

Tatami

4 13:10

Pool

5,6,7,8

(c)sportdata GmbH & Co KG 2000-2024 (2024-12-08 20:16) v 10.2.0 build 1 (2024-11-20 00:58 CET) License: SDIL TVG (expire 2025-01-26)

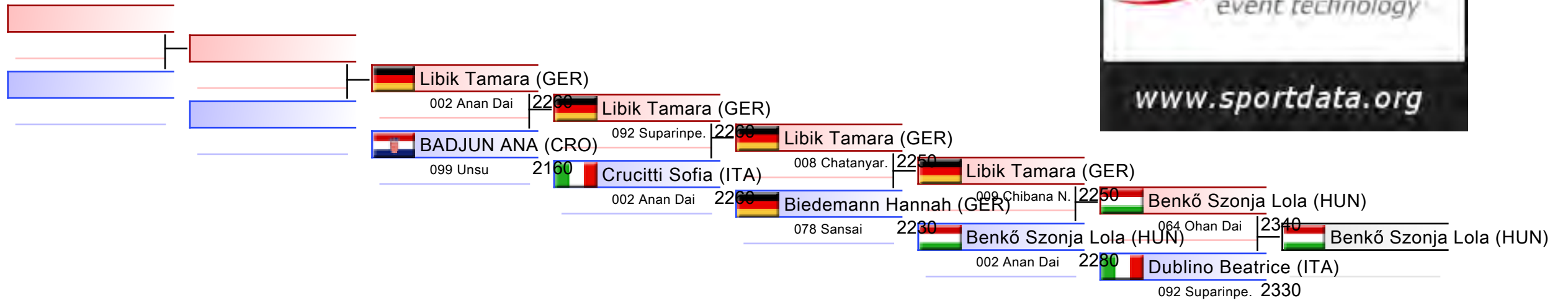

REPECHAGE: (5,6,7,8)

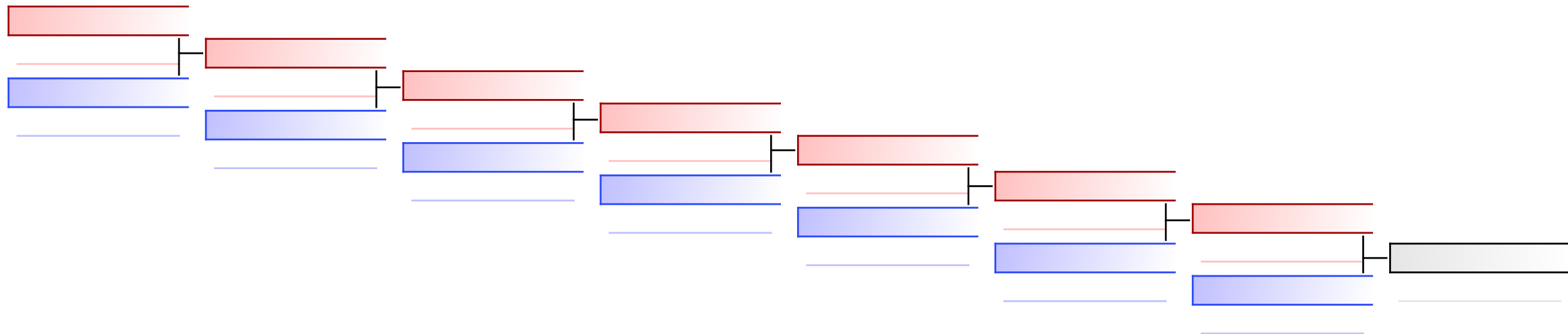



Karate1 Youth League - Venice 2024 - 2024-12-04



Official Results

Cadet Kata Female (Entries: 117 Nations: 30)			
1	HORI RIA		JPN - JAPAN
2	LEHNER TAMARA		AUT - AUSTRIA
3	BENKÓ SZONJA LOLA		HUN - HUNGARY
3	CASTRO LÓPEZ ROCÍO		ESP - SPAIN
5	DUBLINO BEATRICE		ITA - ITALY
5	NAGLEIN EMMA		ITA - ITALY
7	LIBIK TAMARA		GER - GERMANY
7	ASATO COCORO		JPN - JAPAN
9	BIEDEMANN HANNAH		GER - GERMANY
9	ISKANDARYAN ANNE-MARIE		GER - GERMANY
11	CRUCITTI SOFIA		ITA - ITALY
11	BAGHDJIAN DANA		GER - GERMANY
13	BADJUN ANA		CRO - CROATIA
13	DE PACE MARIA LUISA		ITA - ITALY

CADET KATA MALE



Karate1 Youth League - Venice 2024

ENTRIES BY WEIGHT CATEGORY



Cadet Kata Male

As of 8 DEC 2024

Country Code	ID	Gender	Name	Seeding
AUT	AUT030000	M	List Fabio	
BAN	BAN002622	M	CHOUDHURY MAHEEN ADAM	
BEL		M	Gilles Boschmans	
BIH		M	Beganović Taris	
CAN		M	Till Patrick	
CHI	CHI003346	M	MATTA SOTO MARTIN ALONSO ANDRES	
CRO		M	FAIĆ DAVID	
CRO	CRO03422	M	GRGIC OZREN	
CRO		M	Matkovic Grga	
CRO		M	MILIČEVIĆ DOMAGOJ	
CZE		M	Brzobohatý Michal	
CZE		M	Foltýn Martin	
CZE	CZE02712	M	ILCIK ADAM	
CZE	CZE02758	M	STAHLAVSKY DAVID	
CZE		M	Vrátný Lukáš	
DEN	DEN02842	M	Murakami Petersen Lukas	
ENG		M	Altham Caolan	
ENG		M	Langhorn Theo	
ENG		M	Taff Charlie	
ESP		M	ALCALA JIMENEZ ALBERTO	
ESP		M	ALVAREZ FERNANDEZ IZAN	
ESP		M	Castro López Braulio	
ESP		M	LACUEVA MARTINEZ GENIS	
ESP		M	LEÓN DE LA PEÑA JOSE ANGEL	
ESP		M	ORTIZ RUEDA JORGE	
FRA		M	AYAV Charles	
FRA		M	BOUTELIOUA Sohann	
FRA	SD67529	M	Bulumac Sergiu	
FRA		M	ETTORI Thomas	
FRA		M	EYQUEM Zadig	
FRA	SD67357	M	FRANCES Adrien	
FRA		M	HUYET-DUMONG Thomas	
FRA		M	Nock Hugo	
FRA		M	Nock Mathis	
FRA		M	PHOMMAVONG Gabriel	
FRA		M	PILLANT Métis	
FRA		M	SECACHE Timeo	
FRA		M	TRANCARD Lenny	
GER	GER03866	M	ALBIEN ALEXANDER	
GER		M	Al Hamad Mehvan	
GER		M	Braun Daniel	
GER	GER004014	M	BUECKERT JONAS	
GER		M	Haueisen Anton	
GER		M	Jahnsmüller Adrian	
GER		M	Jorde-Nakamatsu Lio	



Karate1 Youth League - Venice 2024

ENTRIES BY WEIGHT CATEGORY



Cadet Kata Male

As of 8 DEC 2024

Country Code	ID	Gender	Name	Seeding
GER		M	Kistner Andrej	
GER	GER03797	M	KUNIYASU HARUAKI	
GER		M	Libik Daniel	
GER		M	Münch Fabio	
GER		M	Wabingga Djego Lee	
HKG	HKG02669	M	WONG NURI	
HUN		M	Miklós-Kokor Alex Balázs	
IRI		M	Ghavam Yazdan	
IRL	IRL02946	M	MC CANN CALVIN	
ITA		M	Brachini Leonardo	
ITA		M	CALDARELLI Fortunato	
ITA		M	Caracateanu Radu cristian	
ITA		M	Cenci Diego	
ITA	ITA005616	M	DELLUOMO DAVIDE	
ITA		M	De Meo Marco	
ITA	ITA005615	M	DE SANCTIS RICCARDO	
ITA		M	FERRI DANIELE	
ITA		M	Freda Matteo	
ITA		M	GIUSTINIANO ALESSIO	
ITA		M	Laboranti Luca	
ITA		M	Lattanzi Cristian	
ITA		M	LEGRENZI FILIPPO	
ITA		M	MARCHESE LUCIO	
ITA		M	Merluzzo Antonio	
ITA		M	MINEO LORENZO	
ITA	SD203995	M	Morelli Filippo	
ITA		M	MORETTI EROS	
ITA	ITA435465	M	NARDACCIO MATTEO	
ITA		M	PAVAN SEBASTIANO	
ITA		M	Pinna Ivan	
ITA		M	ROSIELLO Marco	
ITA		M	TURCATO GIACOMO FILIPPO	
JAM	JAM02216	M	EVANS RASANDRE VALENTINO	
JPN		M	Fukui Kanta	
KOS	KOS02723	M	SALIHU BLENDI	
KUW	KUW02857	M	ALMUTAIRI SAAD	
LAT		M	Jaudzems Gustavs	
MEX	MEX03231	M	Rodriguez Luis	
MNE		M	Stevović Uroš	
NED		M	Noerkhan Rayan	
NOR		M	Meltzer Isaac August	
POL	POL3959	M	GRZESLO IGOR	
POL	POL3414	M	MYDLARZ MICHAL	
POL	POL4137	M	NIEDZIELA MICHAL	
POL	POL06191	M	NOWAK MACIEJ	



Karate1 Youth League - Venice 2024

ENTRIES BY WEIGHT CATEGORY



Cadet Kata Male

As of 8 DEC 2024

Country Code	ID	Gender	Name	Seeding
POL	POL2728	M	WDOWIARSKI ERYK	
POR		M	Borges Troy	
POR		M	Gaspar Rodrigo	
POR	SD59627	M	Mateus Vasco	
POR		M	Santos André	
ROU	ROU03593	M	ISCIUC MATEO EDWARD	
ROU	ROU2438	M	RAZVAN GEORGE FLOREA	
SCO		M	France Kyle	
SLO	SLO02563	M	MILJATOVIC ALEKSA	
SLO	SLO02835	M	OVNIC TIAN	
SRB		M	Banjalučkić Veljko	
SRB		M	Urošević Jovan	
SUI		M	Limacher Ramon	
SUI		M	Lüthy Corsin Dion	
SVK		M	Elias Matus	
SVK	SVK02796	M	GENDES David	
SVK		M	Macko Peter	
SVK	SVK02800	M	Šipkovský Jozef	
SVK		M	Spáčil Samuel	
SVK		M	Stuska Samuel	
SWE	SWE003124	M	JONASSON JAKOB	
SWE	SWE03085	M	LARSSON ERHARDT TRULS	
TKM	TKM02132	M	YALKABOV ALLANUR	
UKR		M	MAKSYMENKO KIRIL	
UKR		M	Nechypurenko Vitalii	
USA		M	Davila Martin	
VEN		M	QUINTANA QUIJADA ENZO EDUARDO	
VEN	VEN003130	M	Ruz Luis	

Cadet Kata Male

Karate1 Youth League - Venice 2024, PALAZZO DEL TURISMO, Piazza Brescia 11, 30016 Lido di Jesolo VE, ITA

2024-12-06

Tatami
1 11:05

Pool
1/8

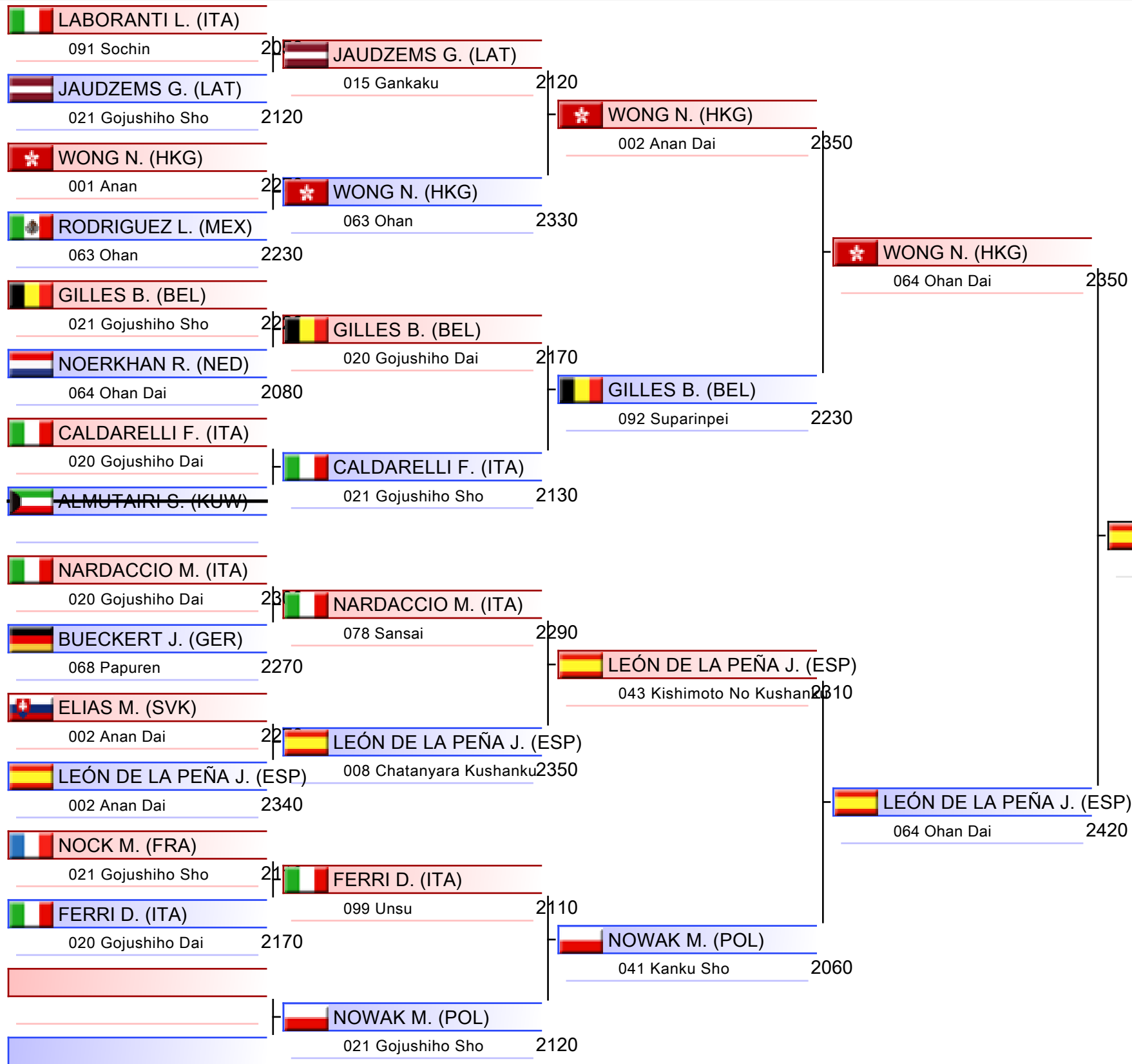

1. FUKUI KANTA (JPN)
2. MATEUS VASCO (POR)
3. DAVILA MARTIN (USA)
3. FREDA MATTEO (ITA)
5. LIBIK DANIEL (GER)
5. LEÓN DE LA PEÑA JOSE ANGEL (ESP)
7. SPÁČIL SAMUEL (SVK)
7. ALBIEN ALEXANDER (GER)

Cadet Kata Male

Karate1 Youth League - Venice 2024, PALAZZO DEL TURISMO, Piazza Brescia 11, 30016 Lido di Jesolo VE, ITA

2024-12-06

Tatami
2 11:05

Pool
2/8

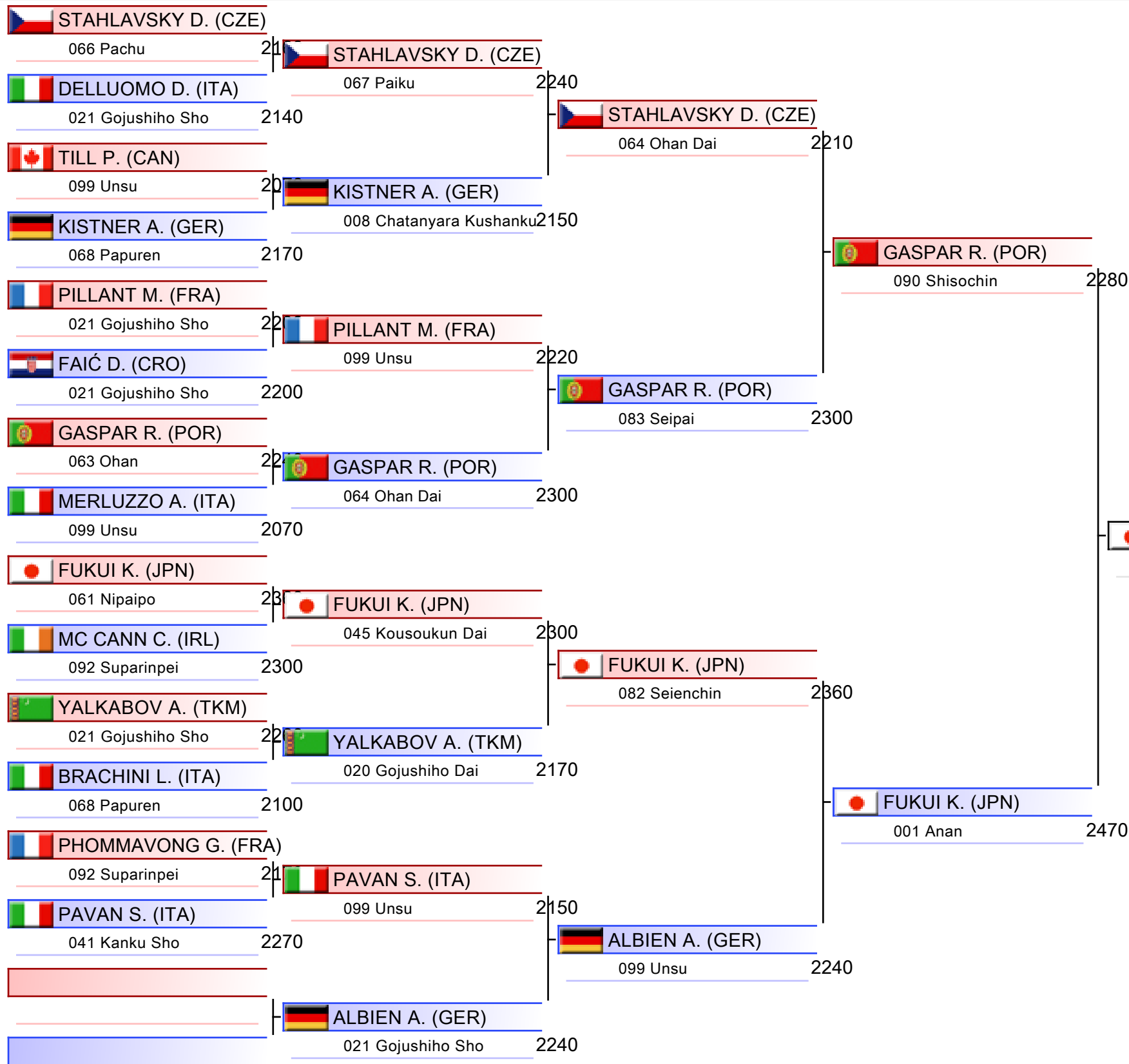

1. FUKUI KANTA (JPN)
2. MATEUS VASCO (POR)
3. DAVILA MARTIN (USA)
3. FRED A MATTEO (ITA)
5. LIBIK DANIEL (GER)
5. LEÓN DE LA PEÑA JOSE ANGEL (ESP)
7. SPÁČIL SAMUEL (SVK)
7. ALBIEN ALEXANDER (GER)

Cadet Kata Male

Karate1 Youth League - Venice 2024, PALAZZO DEL TURISMO, Piazza Brescia 11, 30016 Lido di Jesolo VE, ITA

2024-12-06

Tatami
3 11:05

Pool
3/8

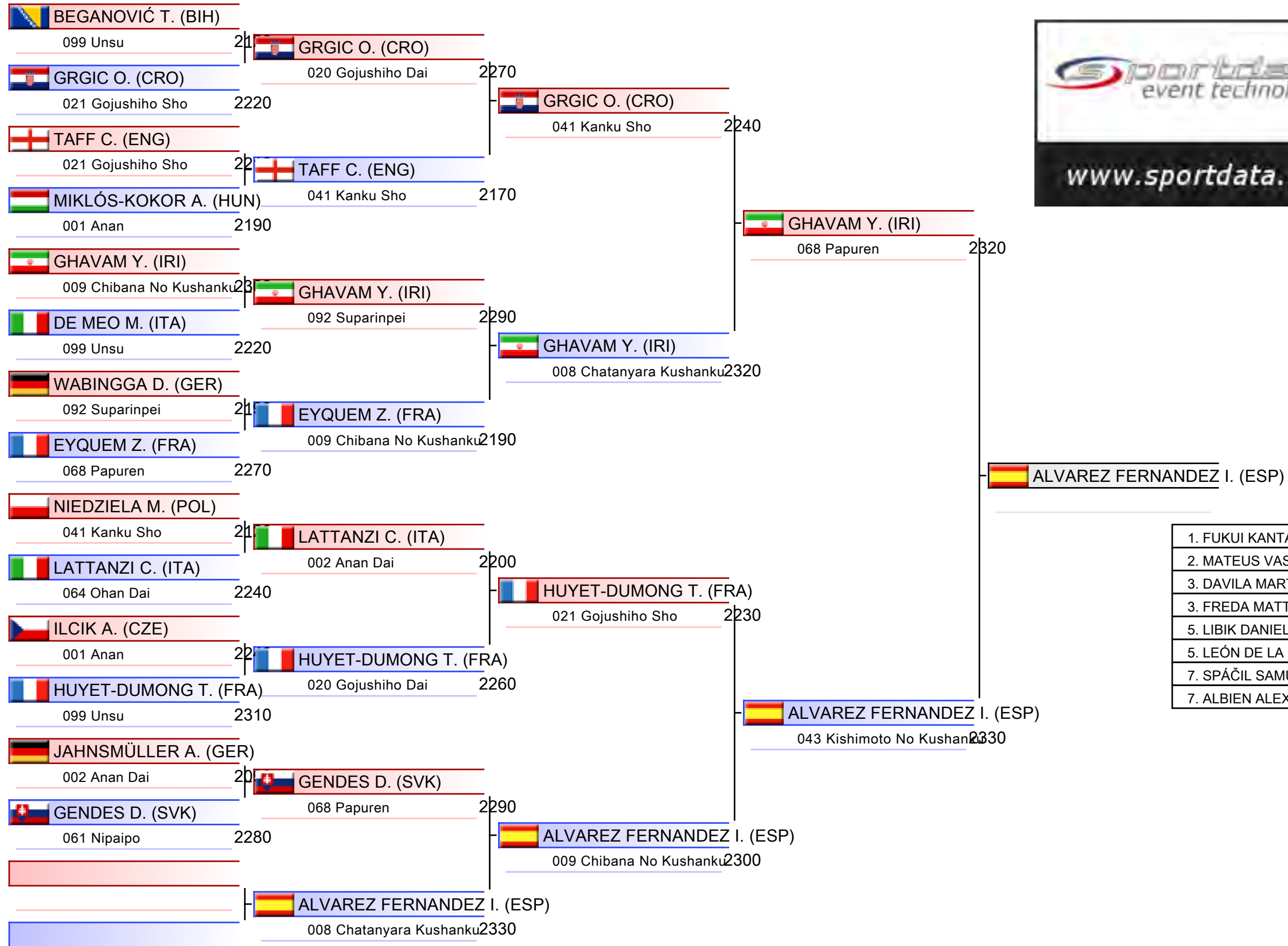

1. FUKUI KANTA (JPN)
2. MATEUS VASCO (POR)
3. DAVILA MARTIN (USA)
3. FREDA MATTEO (ITA)
5. LIBIK DANIEL (GER)
5. LEÓN DE LA PEÑA JOSE ANGEL (ESP)
7. SPÁČIL SAMUEL (SVK)
7. ALBIEN ALEXANDER (GER)

Cadet Kata Male

Karate1 Youth League - Venice 2024, PALAZZO DEL TURISMO, Piazza Brescia 11, 30016 Lido di Jesolo VE, ITA

2024-12-06

Tatami
4 11:05

Pool
4/8

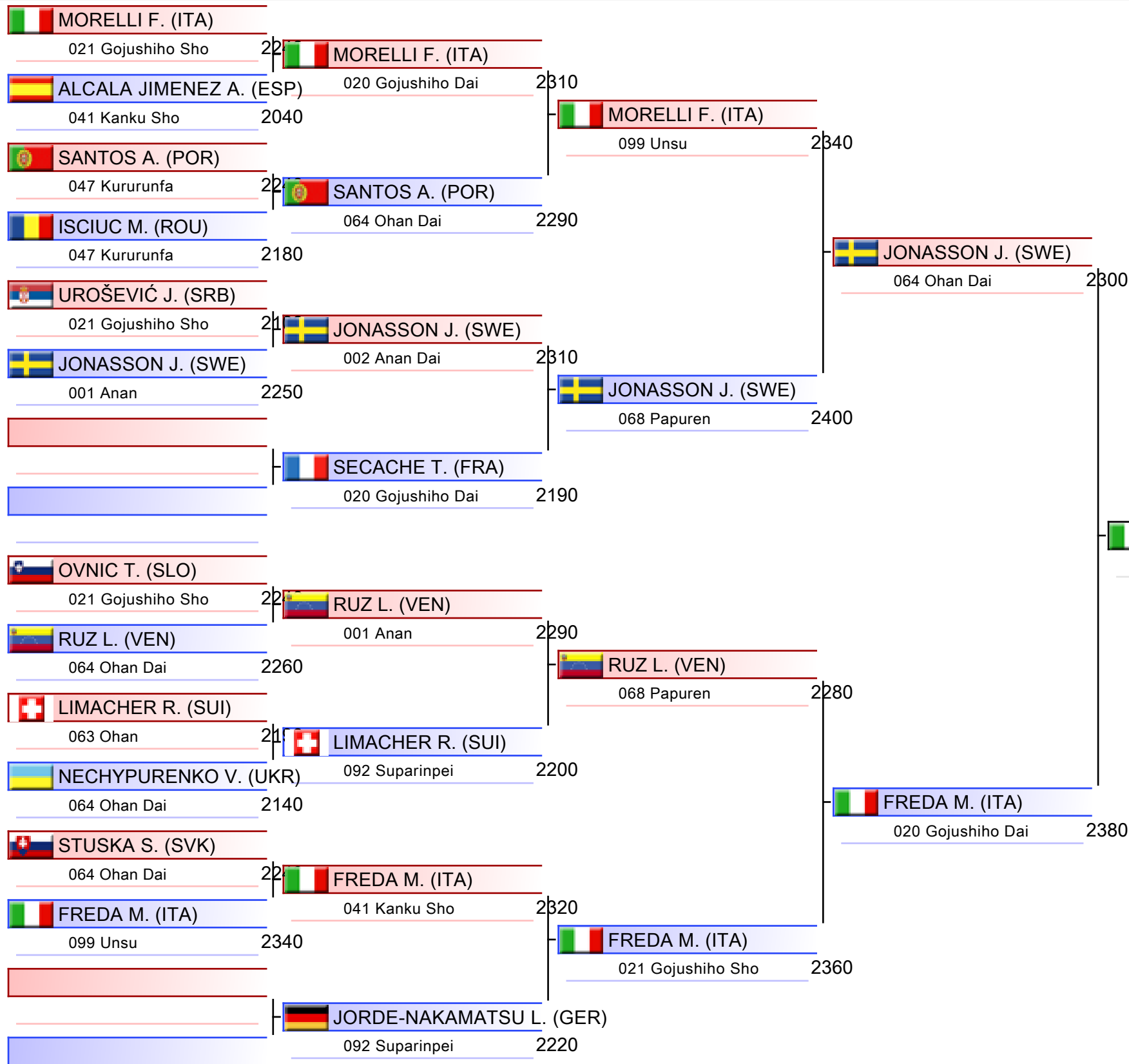

Cadet Kata Male

Karate1 Youth League - Venice 2024, PALAZZO DEL TURISMO, Piazza Brescia 11, 30016 Lido di Jesolo VE, ITA

2024-12-06

Tatami
5 10:55

Pool
5/8

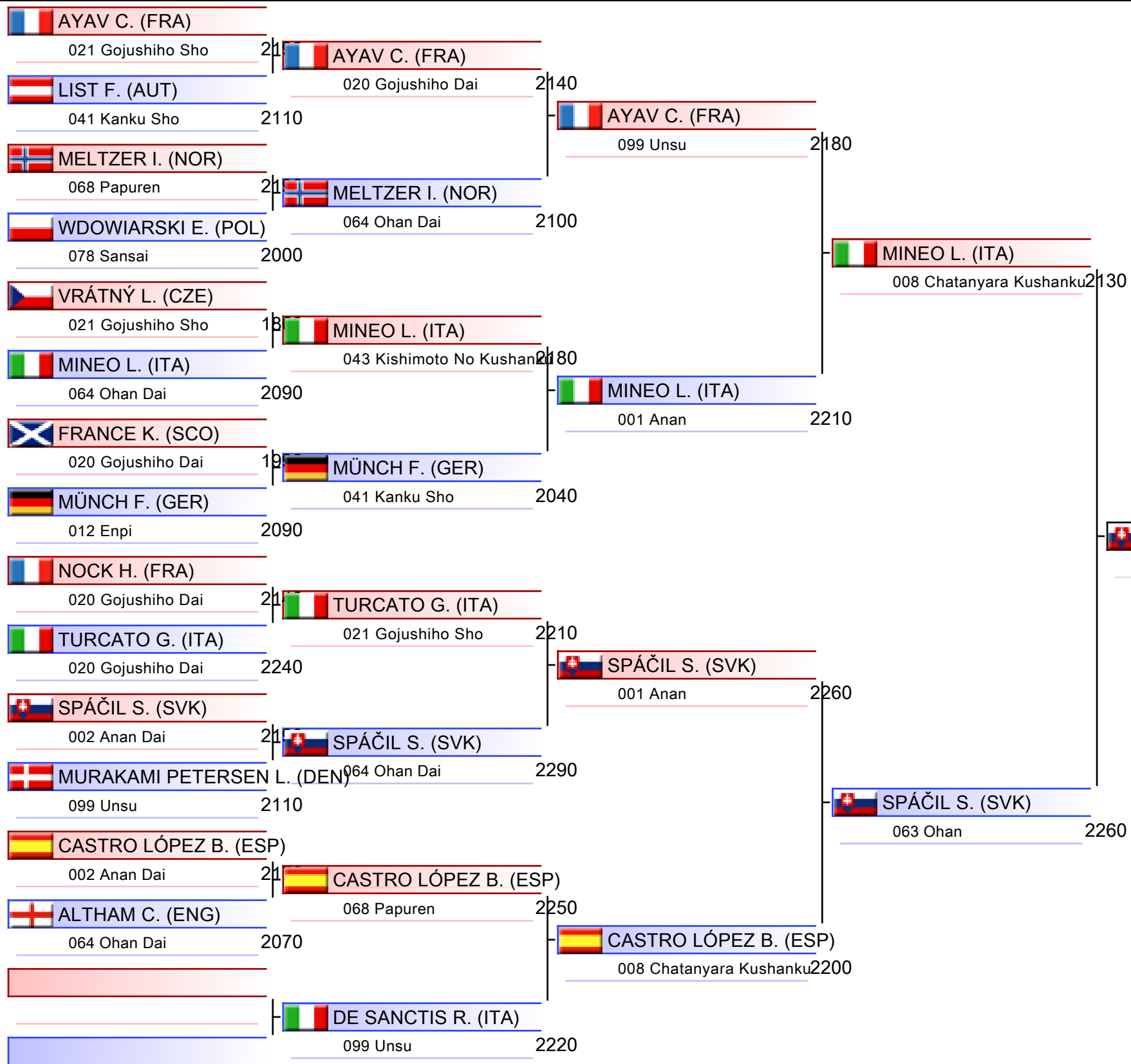

1. FUKUI KANTA (JPN)
2. MATEUS VASCO (POR)
3. DAVILA MARTIN (USA)
3. FREDA MATTEO (ITA)
5. LIBIK DANIEL (GER)
5. LEÓN DE LA PEÑA JOSE ANGEL (ESP)
7. SPÁČIL SAMUEL (SVK)
7. ALBIEN ALEXANDER (GER)

Cadet Kata Male

Karate1 Youth League - Venice 2024, PALAZZO DEL TURISMO, Piazza Brescia 11, 30016 Lido di Jesolo VE, ITA

2024-12-06

Tatami
6 10:55

Pool
6/8

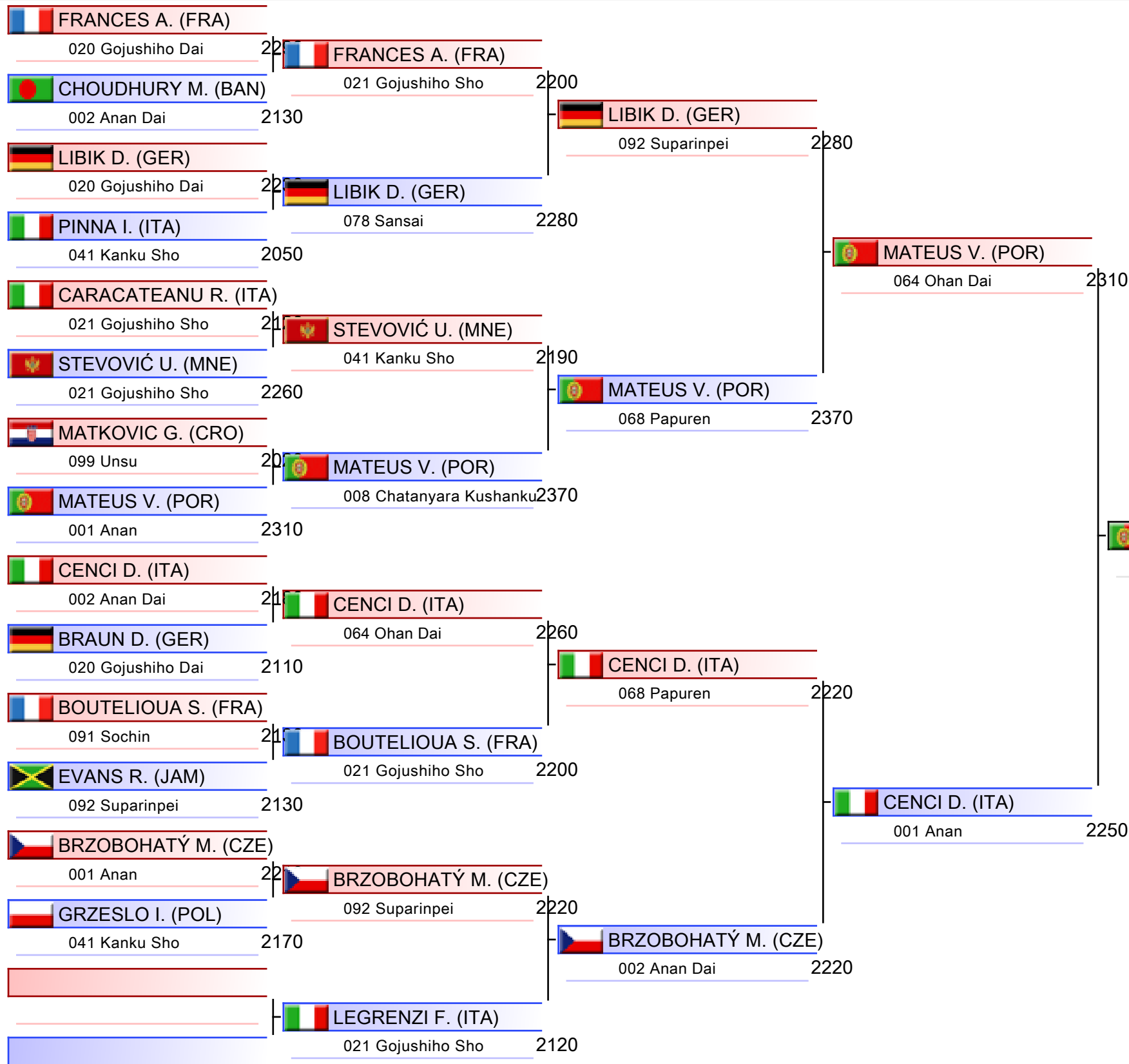

1. FUKUI KANTA (JPN)
2. MATEUS VASCO (POR)
3. DAVILA MARTIN (USA)
3. FREDA MATTEO (ITA)
5. LIBIK DANIEL (GER)
5. LEÓN DE LA PEÑA JOSE ANGEL (ESP)
7. SPÁČIL SAMUEL (SVK)
7. ALBIEN ALEXANDER (GER)

Cadet Kata Male

Karate1 Youth League - Venice 2024, PALAZZO DEL TURISMO, Piazza Brescia 11, 30016 Lido di Jesolo VE, ITA

2024-12-06

Tatami
7 10:55

Pool
7/8

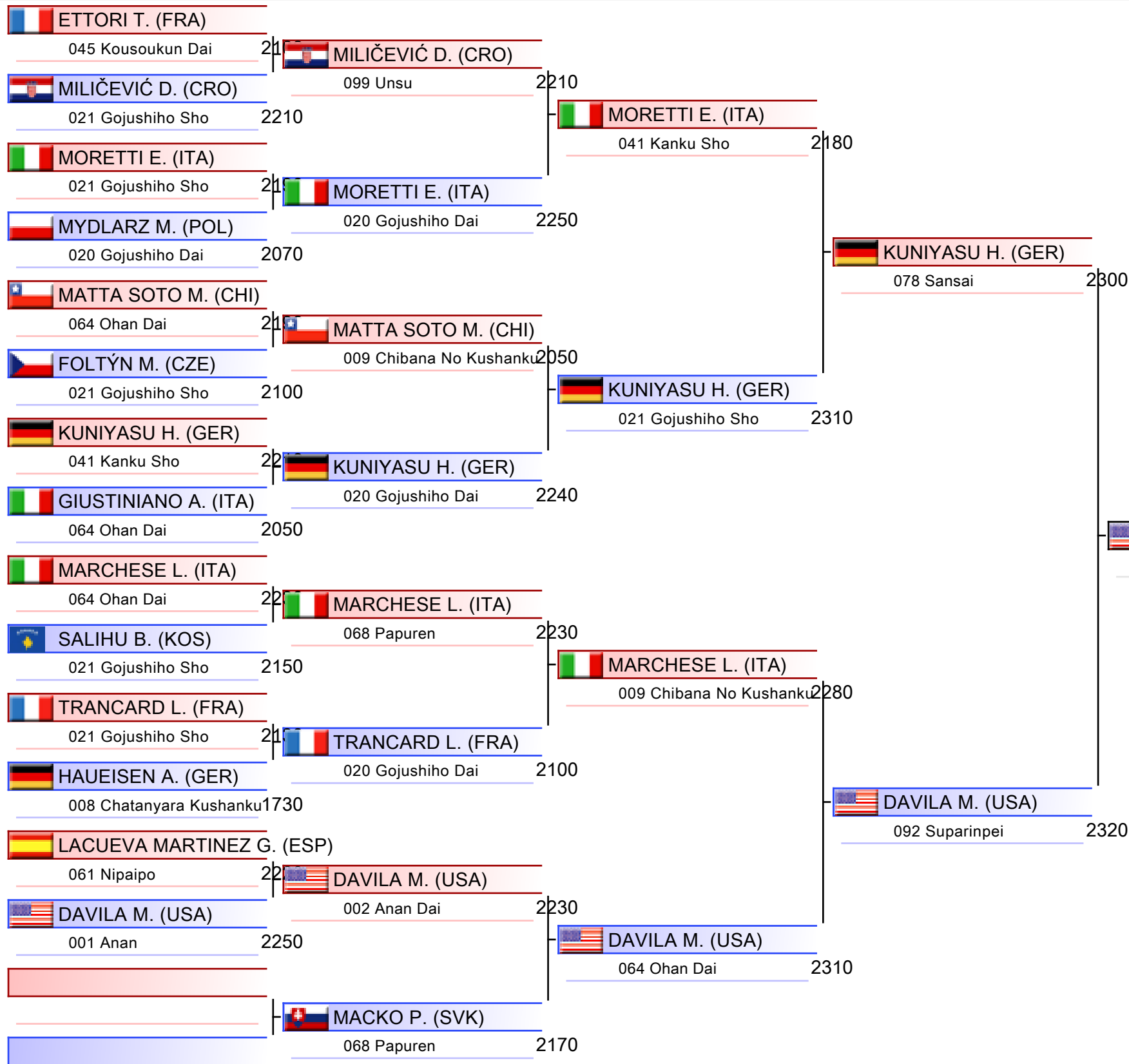

1. FUKUI KANTA (JPN)
2. MATEUS VASCO (POR)
3. DAVILA MARTIN (USA)
3. FRED A MATTEO (ITA)
5. LIBIK DANIEL (GER)
5. LEÓN DE LA PEÑA JOSE ANGEL (ESP)
7. SPÁČIL SAMUEL (SVK)
7. ALBIEN ALEXANDER (GER)

Cadet Kata Male

Karate1 Youth League - Venice 2024, PALAZZO DEL TURISMO, Piazza Brescia 11, 30016 Lido di Jesolo VE, ITA

2024-12-06

Tatami
8 10:55

Pool
8/8

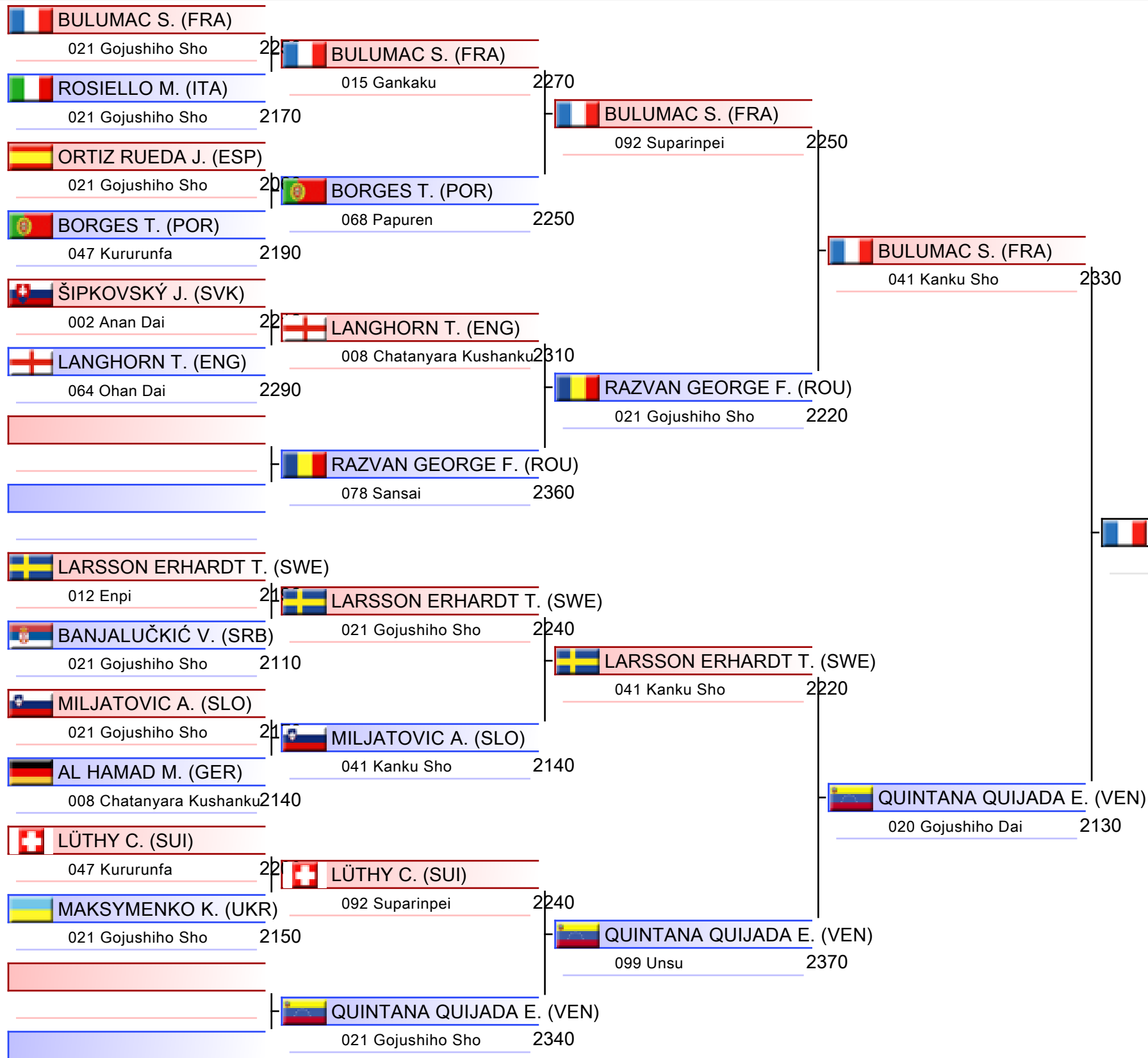

1. FUKUI KANTA (JPN)
2. MATEUS VASCO (POR)
3. DAVILA MARTIN (USA)
3. FREDI MATTEO (ITA)
5. LIBIK DANIEL (GER)
5. LEÓN DE LA PEÑA JOSE ANGEL (ESP)
7. SPÁČIL SAMUEL (SVK)
7. ALBIEN ALEXANDER (GER)

Pool winner-Cadet Kata Male

Karate1 Youth League - Venice 2024, PALAZZO DEL TURISMO, Piazza Brescia 11, 30016 Lido di Jesolo VE, ITA

2024-12-06

Tatami
1 12:45

Pool
1/1

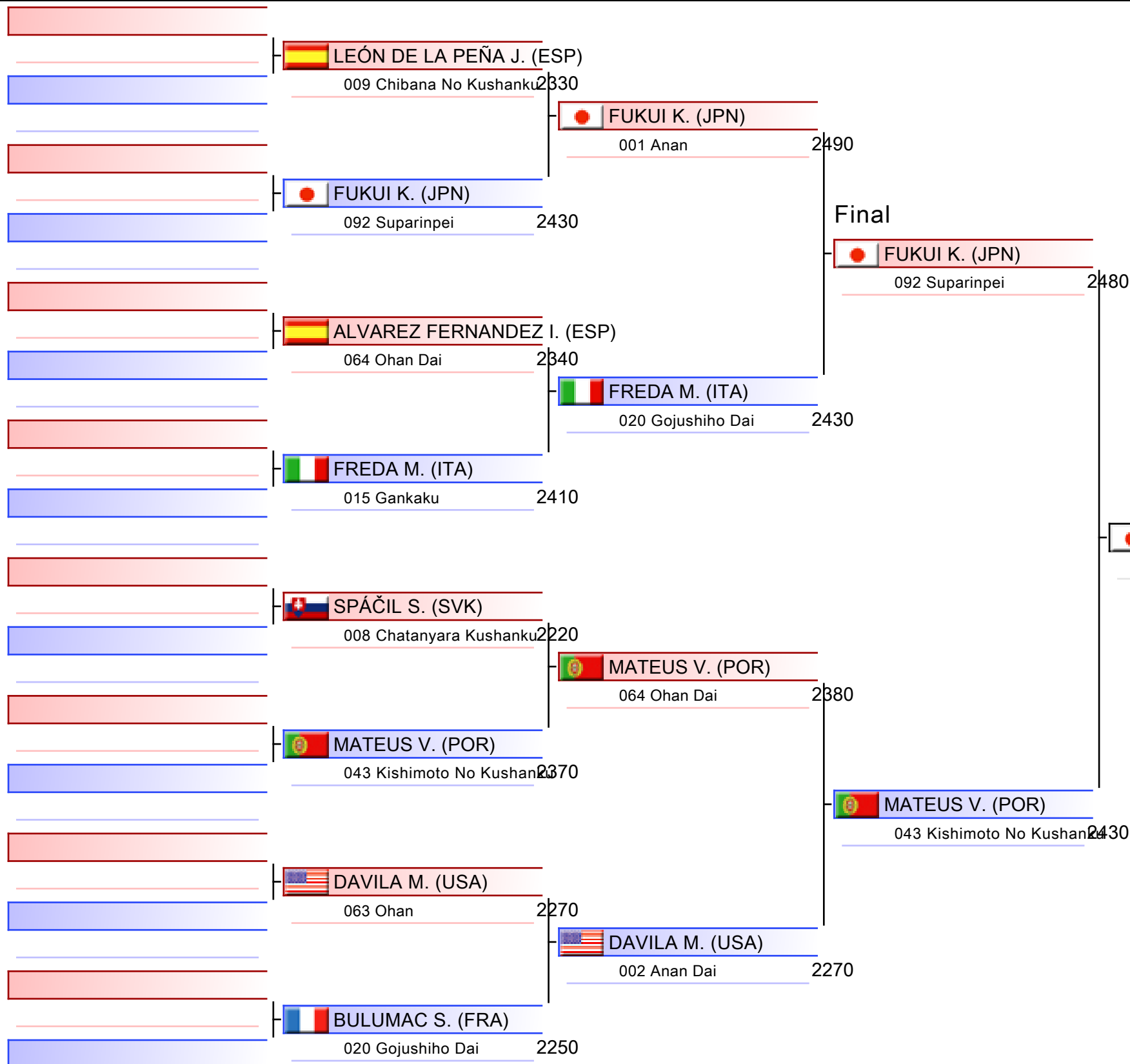

1. FUKUI KANTA (JPN)
2. MATEUS VASCO (POR)
3. DAVILA MARTIN (USA)
3. FREDA MATTEO (ITA)
5. LIBIK DANIEL (GER)
5. LEÓN DE LA PEÑA JOSE ANGEL (ESP)
7. SPÁČIL SAMUEL (SVK)
7. ALBIEN ALEXANDER (GER)

Cadet Kata Male

Karate1 Youth League - Venice 2024

2024-12-06

Tatami

1 13:10

Pool

1,2,3,4

(c)sportdata GmbH & Co KG 2000-2024 (2024-12-08 20:16) v 10.2.0 build 1 (2024-11-20 00:58 CET) License: SDIL TVG (expire 2025-01-26)

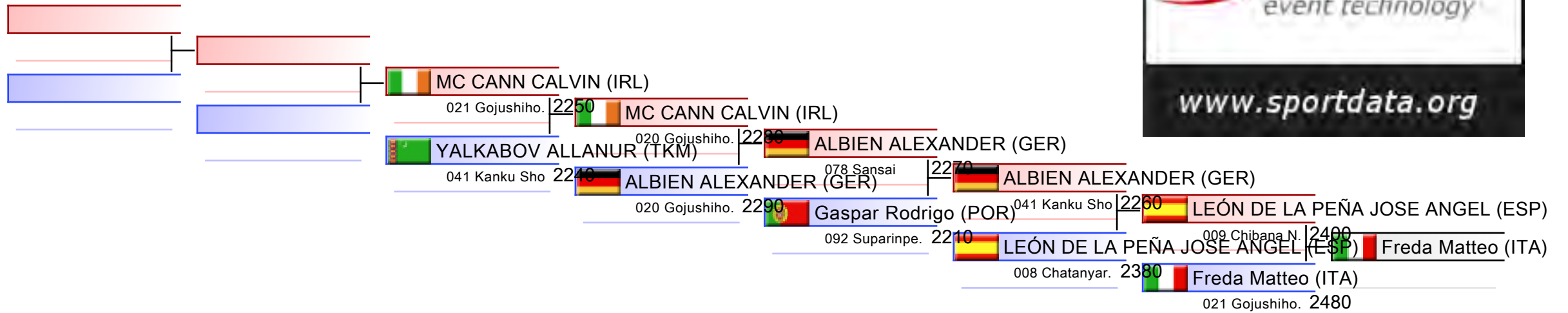

REPECHAGE: (1,2,3,4)

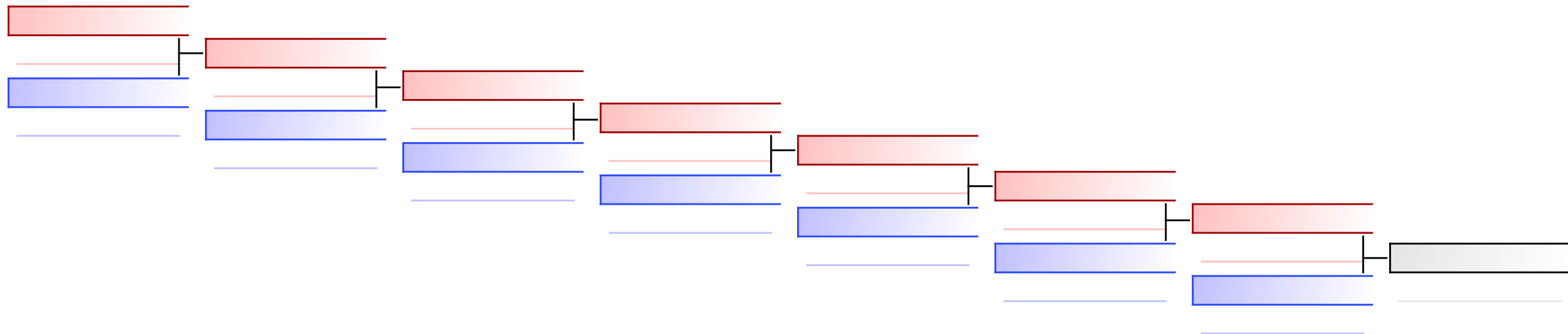

Cadet Kata Male

Karate1 Youth League - Venice 2024

2024-12-06

Tatami
2 13:10

Pool
5,6,7,8

(c)sportdata GmbH & Co KG 2000-2024 (2024-12-08 20:16) v 10.2.0 build 1 (2024-11-20 00:58 CET) License: SDIL TVG (expire 2025-01-26)

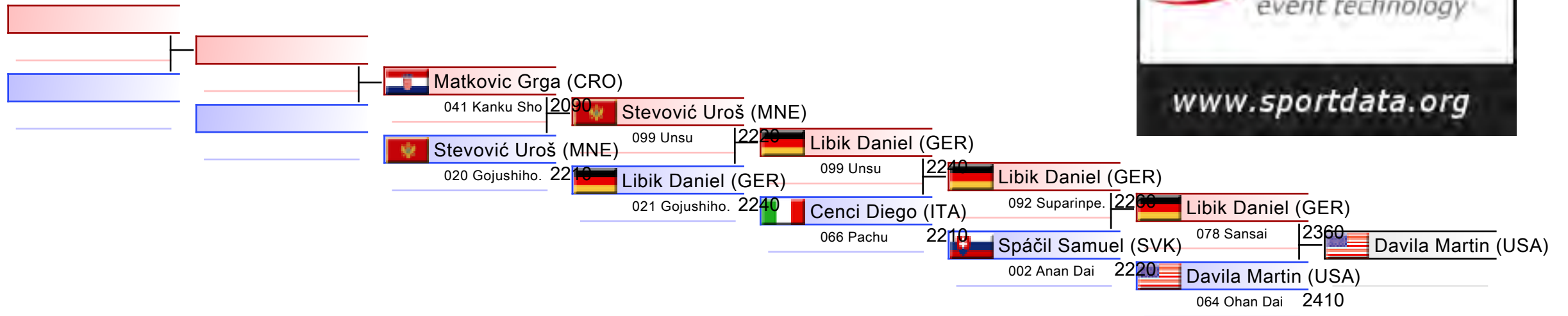

REPECHAGE: (5,6,7,8)

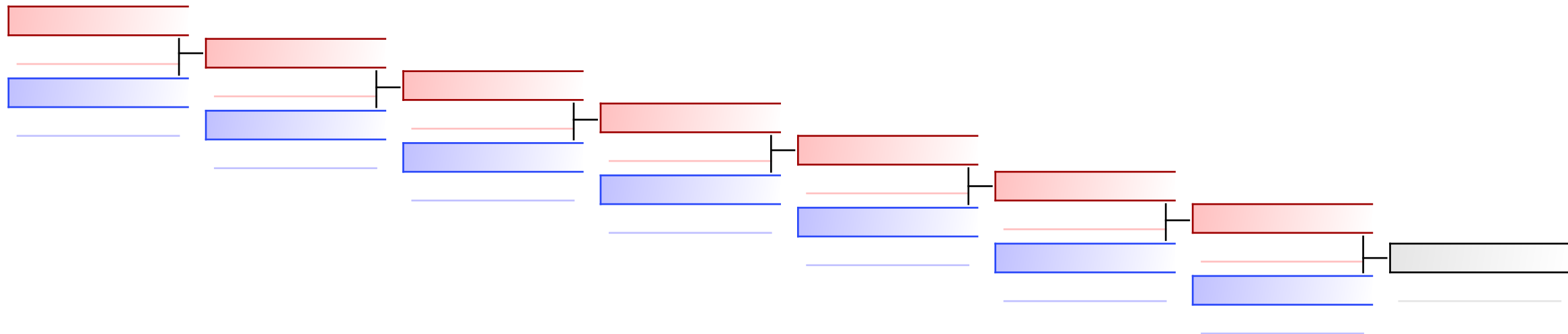



Karate1 Youth League - Venice 2024 - 2024-12-04



Official Results

Cadet Kata Male (Entries: 118 Nations: 40)			
1	FUKUI KANTA		JPN - JAPAN
2	MATEUS VASCO		POR - PORTUGAL
3	DAVILA MARTIN		USA - UNITED STATES
3	FREDA MATTEO		ITA - ITALY
5	LIBIK DANIEL		GER - GERMANY
5	LEÓN DE LA PEÑA JOSE ANGEL		ESP - SPAIN
7	SPAČIL SAMUEL		SVK - SLOVAKIA
7	ALBIEN ALEXANDER		GER - GERMANY
9	CENCI DIEGO		ITA - ITALY
9	GASPAR RODRIGO		POR - PORTUGAL
11	STEVOVIĆ UROŠ		MNE - MONTENEGRO
11	MC CANN CALVIN		IRL - IRELAND
13	MATKOVIC GRGA		CRO - CROATIA
13	YALKABOV ALLANUR		TKM - TURKMENISTAN

CADET KUMITE FEMALE -47 KG



Karate1 Youth League - Venice 2024

ENTRIES BY WEIGHT CATEGORY



Cadet Kumite Female -47 kg

As of 8 DEC 2024

Country Code	ID	Gender	Name	Seeding
AND	AND002257	F	PADILLA AINA	
AUT	AUT03002	F	KIRISITS MIRA	
AZE	AZE03294	F	MAMMADZADA SARVIN	
BIH		F	Ahmetović Tajra	
BIH		F	Šiljak Lejla	
BIH		F	Velagić Hana	
BUL		F	Doncheva Gabriela	
BUL		F	Nikolova Viktoria	
BUL		F	Yakimova Yana	
CRO	CRO03494	F	BESLIJA ELENA	
CRO	CRO03023	F	Bulic Stela	
CRO		F	Čunčić Mia	
ENG		F	Changer Annabel	
ESP		F	Ayerdi Naroa	
ESP		F	GARCIA RUIZ NADIRA	
ESP		F	GÓMEZ SALGADO CARMEN	
ESP		F	SHURMELIOUA LIUBAS STELA	
FRA		F	ALLOUCH Youssra	
FRA		F	KEDADRA Nesrine	
FRA		F	KOUME Lee-Lou	
GER		F	Bruns Laura	
GER	GER003879	F	PODVOREC NIVES	
GER		F	Tahiri Nada	
GRE		F	KOMINI ILIANA	
GRE	GRE03091	F	NIKOLOPOULOU STYLIANI-GEORGIA	
HUN		F	Hefner Zsófia	
HUN		F	Pap Kincsó	
ITA		F	Di Mare Lavinia	
ITA		F	Di Mauro Asia	
ITA		F	GALATI VITTORIA	
ITA		F	GRANELLI GAIA	
ITA		F	GRAZIANI DIANA	
ITA	ITA483231	F	MUCCIA SERENA	
ITA		F	MURGIA ARIANNA	
ITA		F	Pacani Sonila	
ITA		F	panasiti GIULIA	
ITA		F	Paronetto Giorgia	
ITA		F	PAVONE SOFIA	
ITA		F	petruzziello nicole anna	
ITA		F	Sarais Sofia	
ITA		F	Tancredi Matilde	
ITA		F	Tasca Eleonora	
ITA	SD65185	F	Zodda Sofia Francesca	
KOS	KOS03317	F	DRESHA RIGA	
KOS	KOS02901	F	MAQEDONCI EMIRA	



Karate1 Youth League - Venice 2024

ENTRIES BY WEIGHT CATEGORY



Cadet Kumite Female -47 kg

As of 8 DEC 2024

Country Code	ID	Gender	Name	Seeding
KOS	KOS003632	F	SHABANI ELJESA	
KOS	KOS02922	F	ZENUNI RINESA	
NED		F	Lepez Darla	
NOR		F	Olseng Ingrid	
POL	POL3244	F	MELLER ADRIANNA	
POR	POR03181	F	FERNANDES EMA	
POR		F	Gaspar Maria Isabel	
POR		F	Matos Isis	
ROU	ROU03228	F	BALANESCU MARIA	
ROU	ROU03726	F	CONSTANTIN DARIA MIHAELA	
ROU	ROU03604	F	TERPEZAN MARIA	
SLO	SLO03031	F	JERAM VITA	
SRB		F	Sinobad Petra	
SUI		F	NÄF Sylvie	
SUI	SUI03111	F	Özdemir Demet	
SUI		F	Payziner Serena	
SUI		F	Streit Mila Chiara	
SUI		F	von Klass Melissa	
SVK		F	Budajová Ema	
SVK		F	Streicherová Romana	
TUR		F	AKSOY Damla	
TUR		F	AKSOY Duru	
TUR		F	CAKIR ZEYNEP ERVA	
TUR		F	DOGAN ELIF BERRE	
TUR		F	EREVİK Ceylin	
TUR		F	ISIK SIMAY	
UKR		F	Kondratiuk Marharyta	
UKR		F	Konstantynova Daria	
UKR		F	Kozylian Nataliia	
UKR	SD66473	F	Kruhlyk Yelyzaveta	
UKR		F	Kurash Veronika	
UKR		F	Maistrenko Hanna	
UKR		F	Orlova Vladyslava	
UKR		F	OSTAPENKO ALISA	
UKR		F	SEMENIUK SOFIIA	
UKR		F	Skibchuk Kira	
UKR		F	STANOVSKA VERONIKA	
UKR		F	Turanska Anastasiia	
UKR		F	Tyshyna Veronika	
UKR		F	Uhnich Sofiia	
UKR		F	Zlatova Uliana	

Cadet Kumite Female -47 kg

Karate1 Youth League - Venice 2024, PALAZZO DEL TURISMO, Piazza Brescia 11, 30016 Lido di Jesolo VE, ITA

2024-12-06

Tatami
1 17:50

Pool
1/4

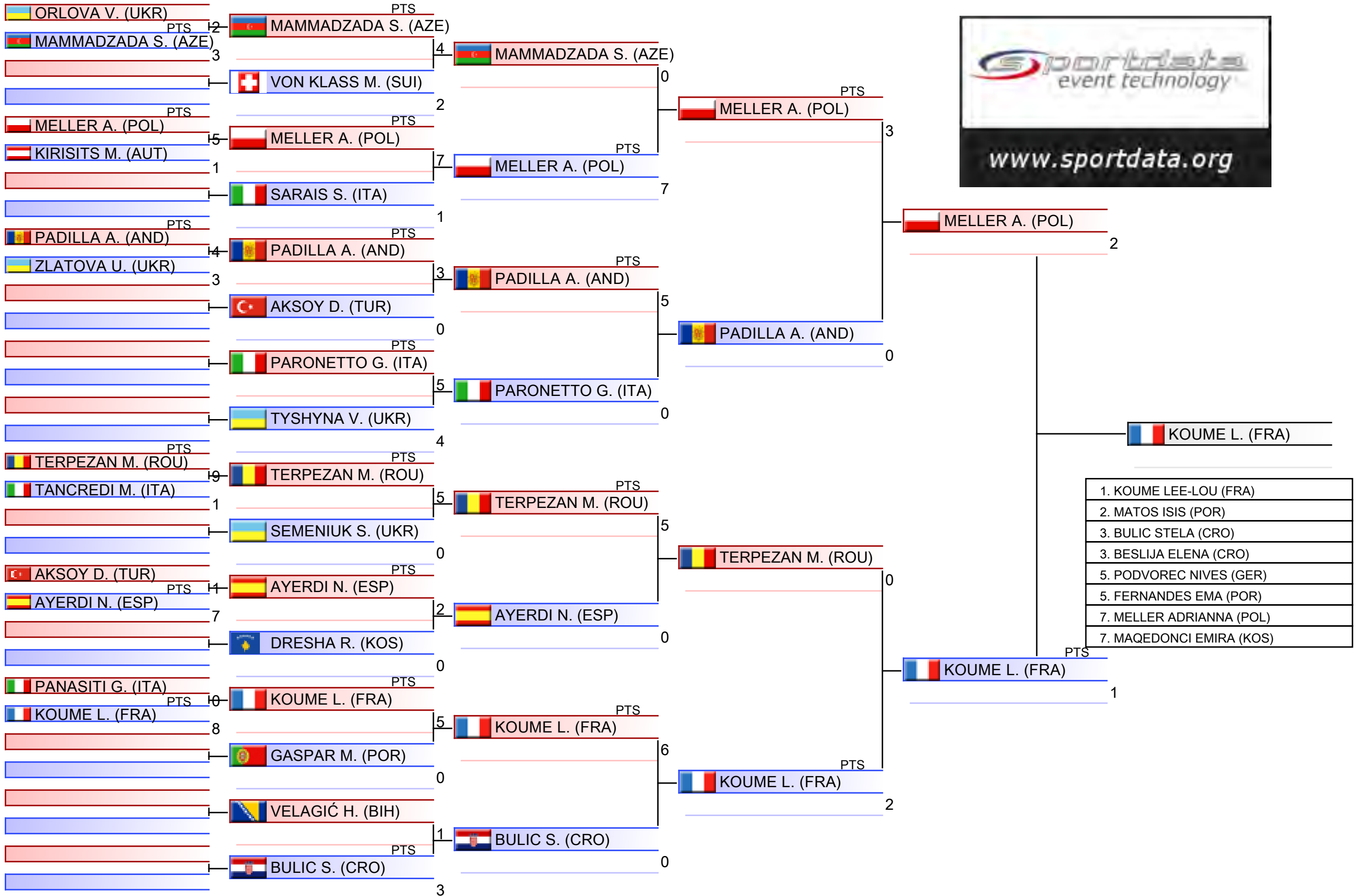

Cadet Kumite Female -47 kg

Karate1 Youth League - Venice 2024, PALAZZO DEL TURISMO, Piazza Brescia 11, 30016 Lido di Jesolo VE, ITA

2024-12-06

Tatami
2 17:50

Pool
2/4

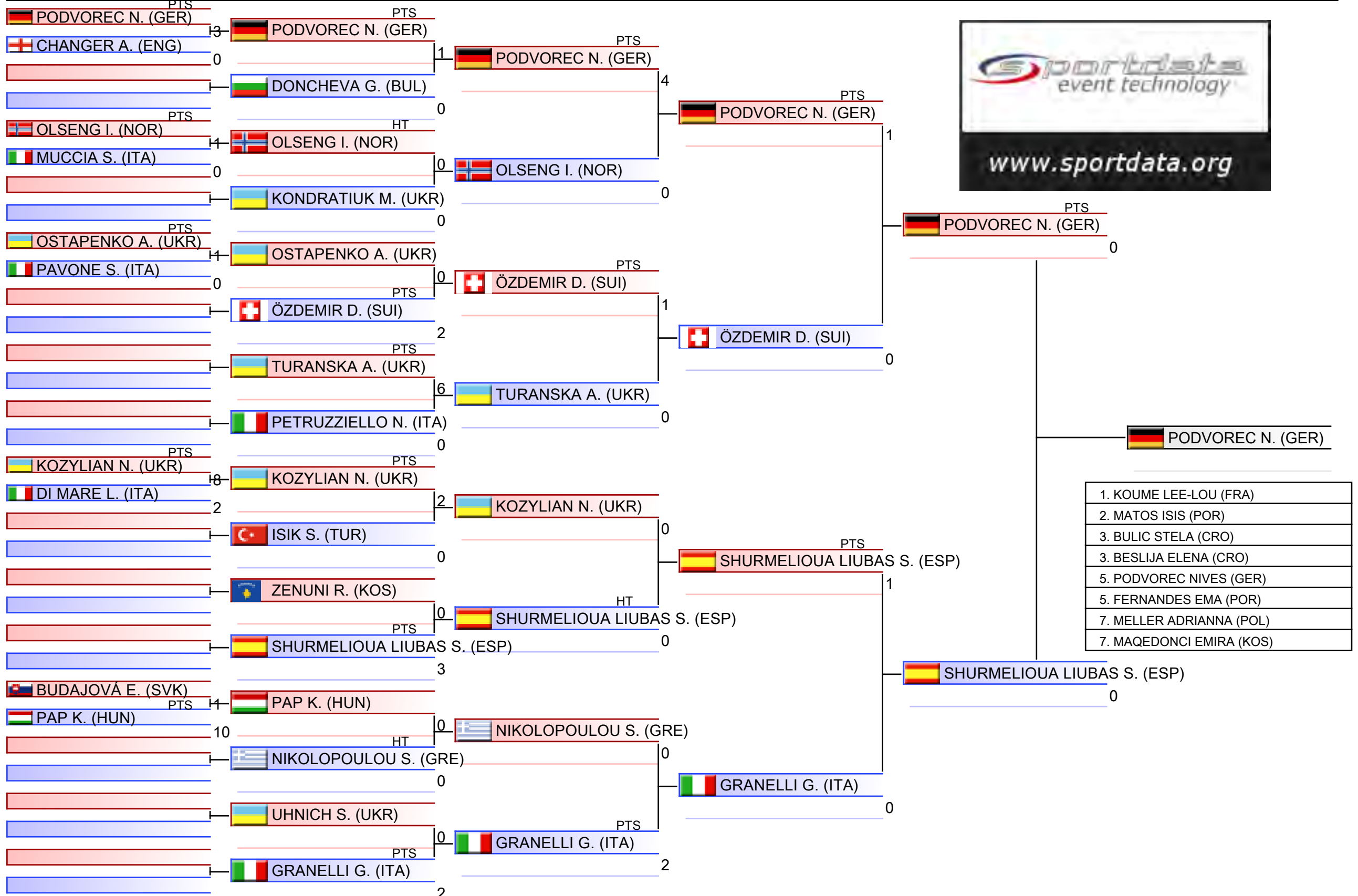

1. KOUME LEE-LOU (FRA)
2. MATOS ISIS (POR)
3. BULIC STELA (CRO)
3. BESLIJA ELENA (CRO)
5. PODVOREC NIVES (GER)
5. FERNANDES EMA (POR)
7. MELLER ADRIANNA (POL)
7. MAQEDONCI EMIRA (KOS)

Cadet Kumite Female -47 kg

Karate1 Youth League - Venice 2024, PALAZZO DEL TURISMO, Piazza Brescia 11, 30016 Lido di Jesolo VE, ITA

2024-12-06

Tatami
3 17:50

Pool
3/4

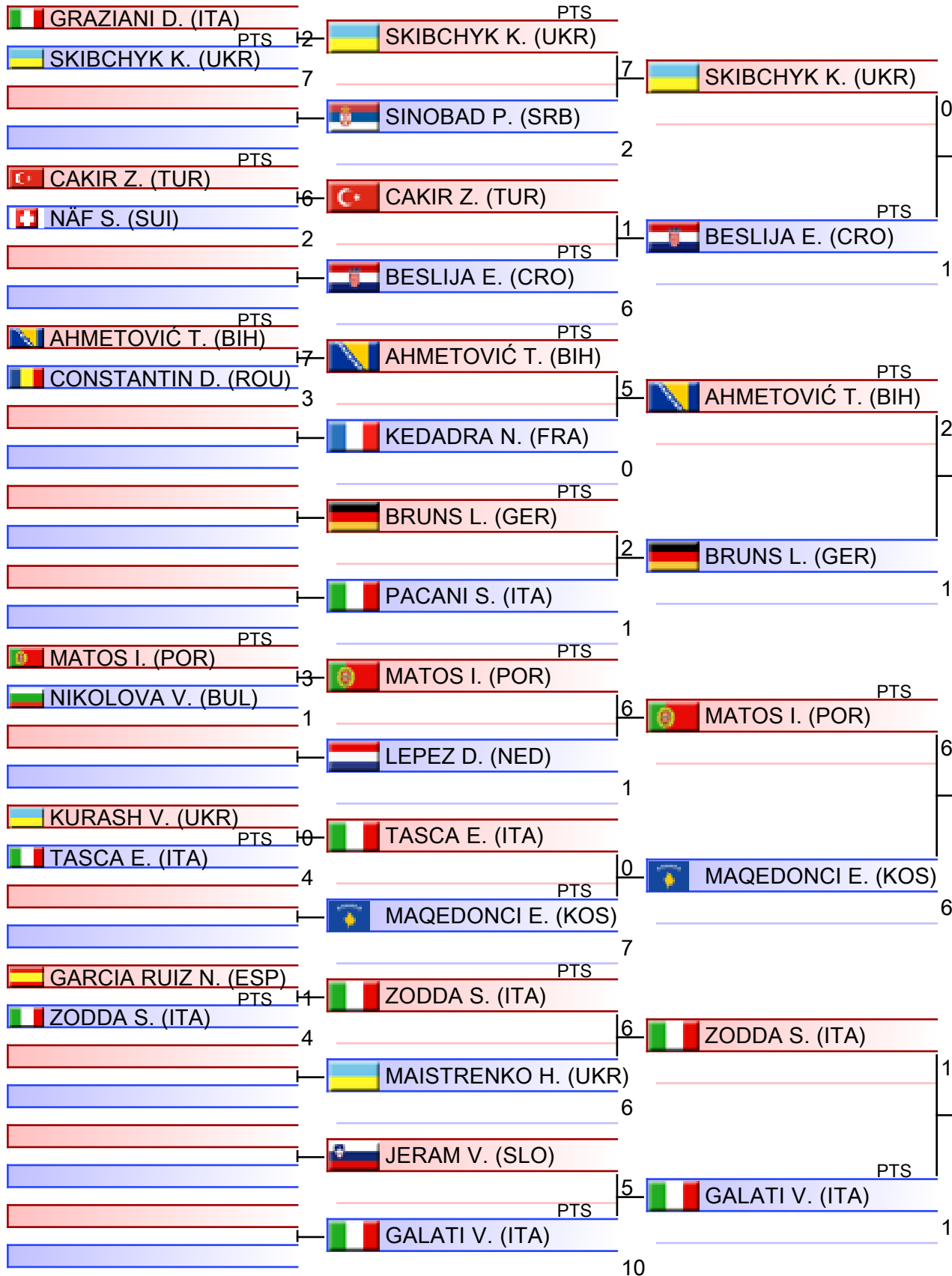

1.	KOUME LEE-LOU (FRA)
2.	MATOS ISIS (POR)
3.	BULIC STELA (CRO)
3.	BESLIJA ELENA (CRO)
5.	PODVOREC NIVES (GER)
5.	FERNANDES EMA (POR)
7.	MELLER ADRIANNA (POL)
7.	MAQEDONCI EMIRA (KOS)

Cadet Kumite Female -47 kg

Karate1 Youth League - Venice 2024, PALAZZO DEL TURISMO, Piazza Brescia 11, 30016 Lido di Jesolo VE, ITA

2024-12-06

Tatami
4 17:50

Pool
4/4

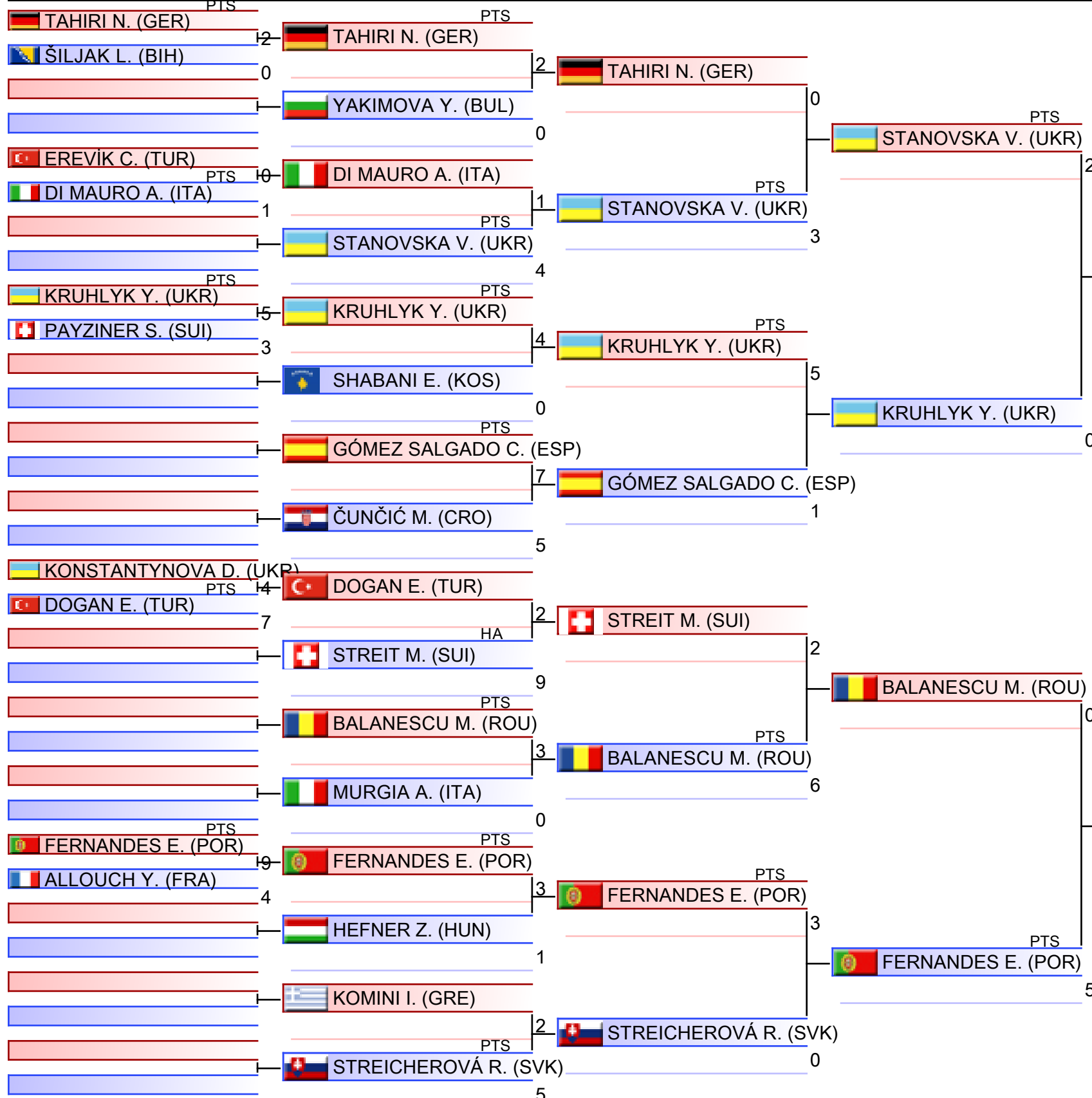

1. KOUME LEE-LOU (FRA)
2. MATOS ISIS (POR)
3. BULIC STELA (CRO)
3. BESLIJA ELENA (CRO)
5. PODVOREC NIVES (GER)
5. FERNANDES EMA (POR)
7. MELLER ADRIANNA (POL)
7. MAQEDONCI EMIRA (KOS)

Pool winner-Cadet Kumite Female -47 kg

Karate1 Youth League - Venice 2024, PALAZZO DEL TURISMO, Piazza Brescia 11, 30016 Lido di Jesolo VE, ITA

2024-12-06

Tatami
3 19:45

Pool
1/1

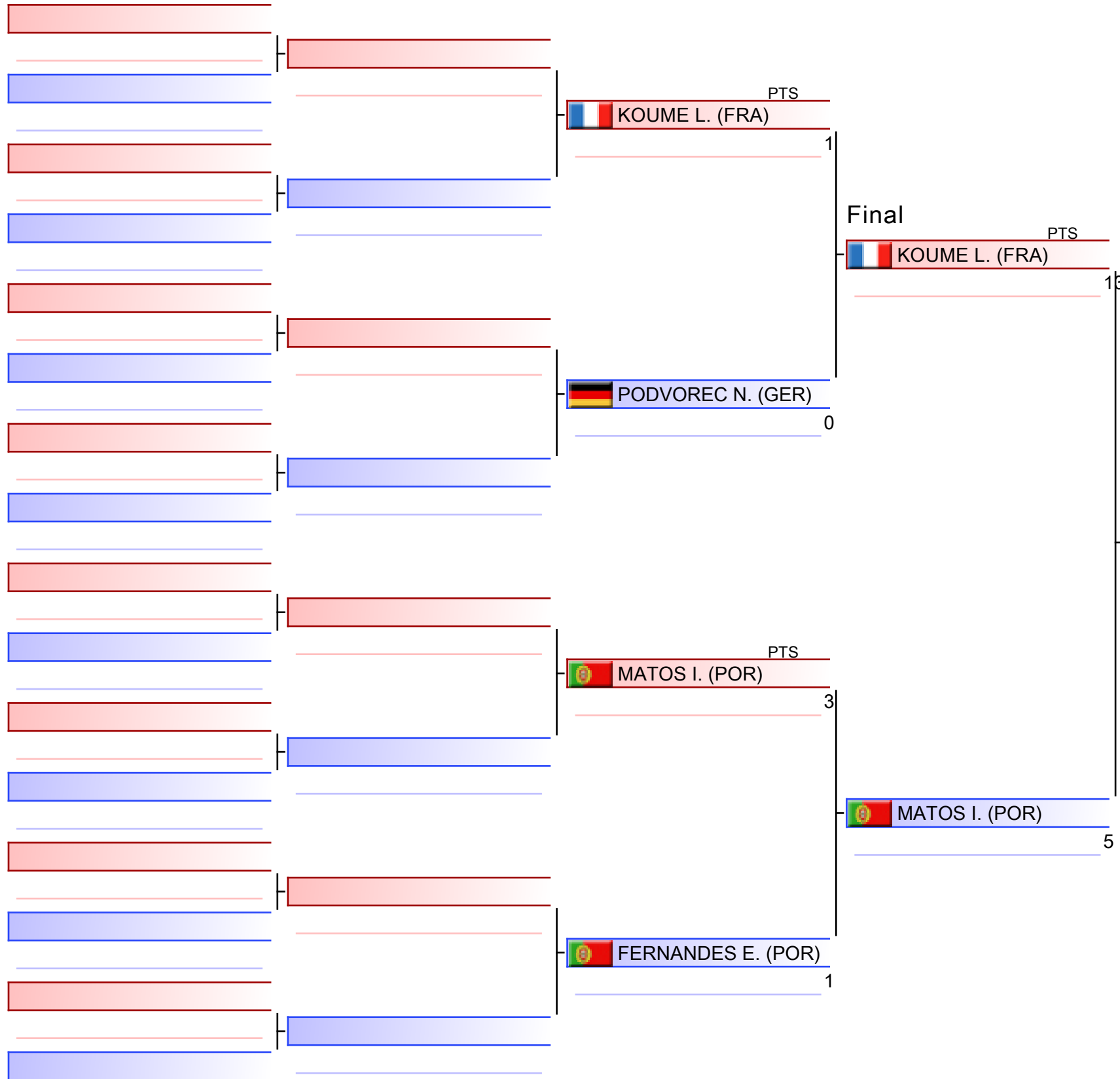

KOUME L. (FRA)

1. KOUME LEE-LOU (FRA)
2. MATOS ISIS (POR)
3. BULIC STELA (CRO)
3. BESLIJA ELENA (CRO)
5. PODVOREC NIVES (GER)
5. FERNANDES EMA (POR)
7. MELLER ADRIANNA (POL)
7. MAQEDONCI EMIRA (KOS)

Cadet Kumite Female -47 kg

Karate1 Youth League - Venice 2024

2024-12-06

Tatami
1 19:50

Pool
1,2

(c)sportdata GmbH & Co KG 2000-2024 (2024-12-08 20:16) v 10.2.0 build 1 (2024-11-20 00:58 CET) License: SDIL TVG (expire 2025-01-26)

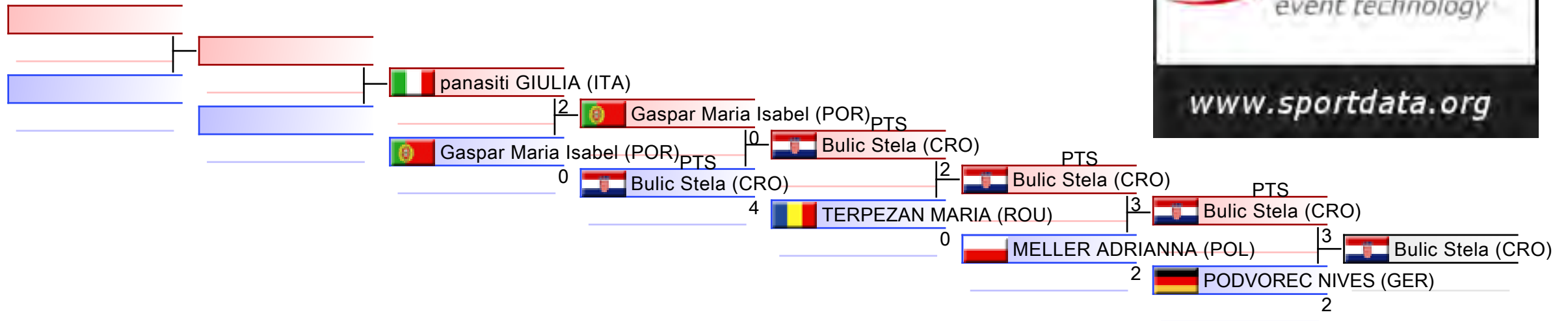

REPECHAGE: (1,2)

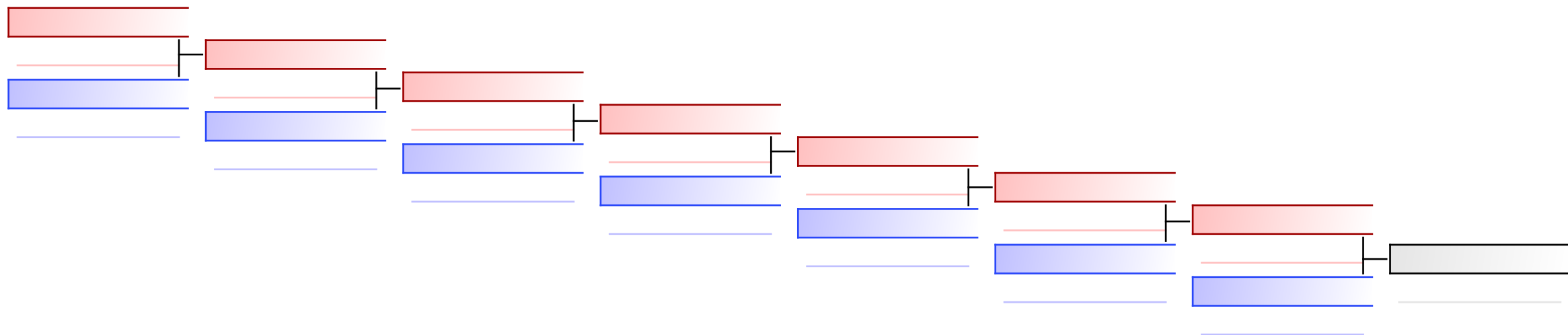

Cadet Kumite Female -47 kg

Karate1 Youth League - Venice 2024

2024-12-06

Tatami
3 19:50

Pool
3,4

(c)sportdata GmbH & Co KG 2000-2024 (2024-12-08 20:16) v 10.2.0 build 1 (2024-11-20 00:58 CET) License: SDIL TVG (expire 2025-01-26)

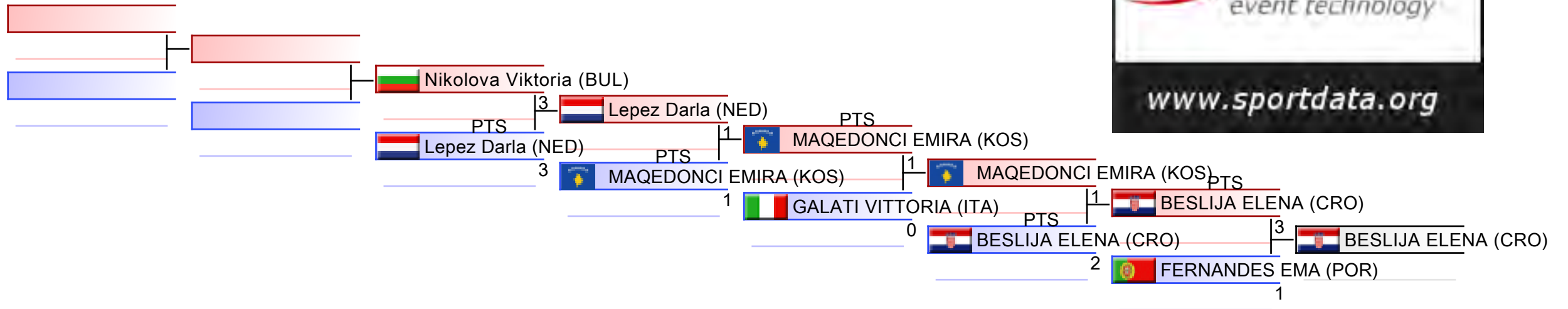

REPECHAGE: (3,4)

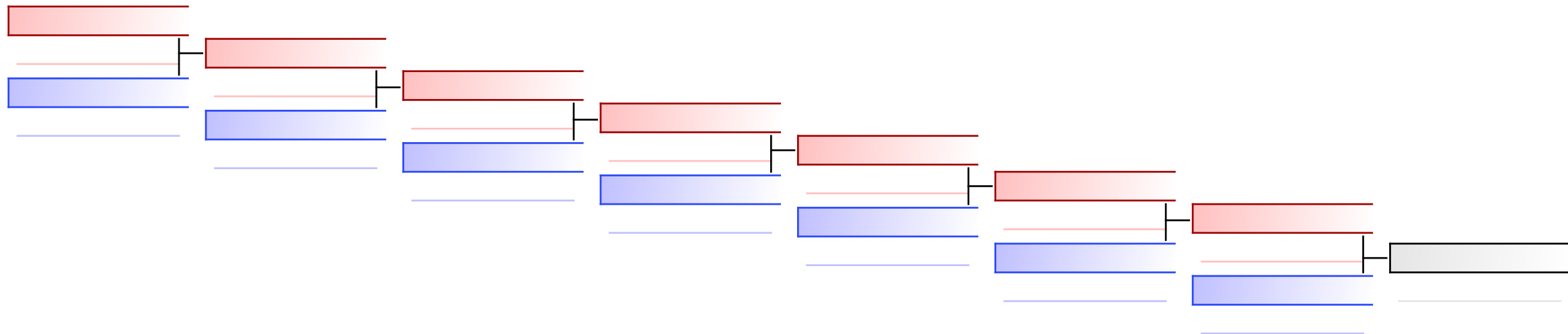



Karate1 Youth League - Venice 2024 - 2024-12-04



Official Results

Cadet Kumite Female -47 kg (Entries: 86 Nations: 25)			
1	KOUME LEE-LOU		FRA - FRANCE
2	MATOS ISIS		POR - PORTUGAL
3	BULIC STELA		CRO - CROATIA
3	BESLIJA ELENA		CRO - CROATIA
5	PODVOREC NIVES		GER - GERMANY
5	FERNANDES EMA		POR - PORTUGAL
7	MELLER ADRIANNA		POL - POLAND
7	MAQEDONCI EMIRA		KOS - KOSOVO
9	TERPEZAN MARIA		ROU - ROMANIA
9	GALATI VITTORIA		ITA - ITALY
11	GASPAR MARIA ISABEL		POR - PORTUGAL
11	LEPEZ DARLA		NED - NETHERLANDS
13	PANASITI GIULIA		ITA - ITALY
13	NIKOLOVA VIKTORIA		BUL - BULGARIA

CADET KUMITE FEMALE -54 KG



Karate1 Youth League - Venice 2024

ENTRIES BY WEIGHT CATEGORY



Cadet Kumite Female -54 kg

As of 8 DEC 2024

Country Code	ID	Gender	Name	Seeding
AUT		F	Greif Aurelia	
AUT		F	Sakanovic Adna	
BEL		F	Hadara Ikram	
BEL	BEL003217	F	Poskin Emilie	
BIH		F	Alajbegović Ajna	
BIH		F	Šeta Zejneb	
BUL	BUL02459	F	BOYADZHIEVA ADRIANA	
CAN	CAN03647	F	RATHNAYAKE MUTHULI	
CRO	CRO03367	F	BRLETIC ELENA	
CRO		F	Glavina Ana-Marija	
CRO	CRO03396	F	MAGDALENIC PAULINA	
CRO	CRO03470	F	Marić Iva	
CRO		F	Marković Nicole	
CRO		F	Mileta Mare	
CRO		F	Vidović Carla	
CRO	CRO04160	F	ZAMLIC ZARA MARIE	
CYP		F	KYRIACOU STAVRI	
CZE		F	Kundrátová Lenka	
CZE		F	Lavičková Nelli	
CZE		F	Vodrážková Eliška	
CZE		F	Vodrážková Nella	
ENG		F	Cutler Sofia	
ENG		F	Harjan Maya-Andreea	
ENG		F	Mepham Emma	
ENG		F	SLADE HOLLY	
ENG		F	Slattery Imogen	
ESP		F	Bustamante DANIELA	
ESP		F	PARACUELLOS ELICES LOLA	
ESP		F	SIGÜENZA CRUCES SANDRA	
FRA		F	Colin-Rose Jade	
FRA		F	ECHAMAA Maryam	
FRA		F	Frances Manon	
FRA		F	PLANCHENOT Maelys	
FRA	SD56205	F	Scarfone Morgane	
GER		F	Damm Lisa	
GER		F	Gottschalk Emma	
GER		F	Lowry Livia	
GER		F	Ruppel Maria	
GER	GER03806	F	SAFI MALLAK	
GRE	GRE03745	F	RESVANI VASILIKI	
GRE	GRE03081	F	TSALAVOU ELENI MYRTO	
HUN		F	Pénzes Csiszár Fruzsina	
HUN		F	Róka Lilla	
ITA		F	arena federica	
ITA		F	Bertoldo Monica	



Karate1 Youth League - Venice 2024

ENTRIES BY WEIGHT CATEGORY



Cadet Kumite Female -54 kg

As of 8 DEC 2024

Country Code	ID	Gender	Name	Seeding
ITA		F	BIANCO ILARIA	
ITA		F	Butini Margherita	
ITA		F	CASCIOFERRO CARLA	
ITA		F	Cerchi Elisa	
ITA		F	DALLAVALLE EVA	
ITA		F	DELNEVO ALESSIA	
ITA		F	FASTIGARI VIOLA EMILIA	
ITA		F	Laouzai Yasmine	
ITA		F	LIVELLI GINEVRA	
ITA		F	LONGERI AURORA	
ITA		F	Marenco Maya	
ITA		F	Milea Maya	
ITA		F	Ministro Flavia	
ITA		F	Rosina Giulia	
ITA		F	SELLITTI ANNA	
ITA		F	VALERIO LAURA	
KOS	KOS03302	F	BILALLI ELMA	
KOS	KOS02932	F	HALIMI SUELA	
LAT		F	Jelinska Kinga Magdalena	
MDA	MDA02341	F	RADAUTA LOREDANA	
NED	SD66426	F	Vlieland Kayleigh	
NOR		F	Johansen Madeleine	
NOR		F	Martby Linnea	
POL	POL09532	F	KASZYNSKA ALICJA	
POL	POL3210	F	Smoczyńska Amelia	
POR	POR03182	F	GONCALVES LEONOR	
POR		F	MOURA LEONOR	
POR		F	PINHEIRO SOFIA	
POR		F	Varanda Gabriela	
ROU	ROU03229	F	BALANESCU IOANA	
ROU		F	HOANG MINH CHAU	
ROU	ROU02702	F	SULU KARINA MIHAELA	
SLO	SLO02689	F	MLAKAR NIKA	
SLO	SLO02691	F	ZUPANCIC NANA	
SRB		F	Kecap Hana	
SRB		F	Vincic Jana	
SRB		F	Vulovic Teodora	
SUI		F	Dumitras Pia	
SUI		F	Tscharner Anais	
SVK	SD70975	F	Ilavská Kristína	
SVK	SD77102	F	Kollárová Patrícia	
SVK		F	Nádašdiová Natália	
SVK		F	Ševčíková Viktória	
SWE		F	Mahmic Sara	
SWE		F	Tesic Aleksandra	



Karate1 Youth League - Venice 2024
ENTRIES BY WEIGHT CATEGORY



Cadet Kumite Female -54 kg
As of 8 DEC 2024

Country Code	ID	Gender	Name	Seeding
UKR		F	Sydorska Marharyta	

Cadet Kumite Female -54 kg

Karate1 Youth League - Venice 2024, PALAZZO DEL TURISMO, Piazza Brescia 11, 30016 Lido di Jesolo VE, ITA

2024-12-07

Tatami
5 13:10

Pool
1/4

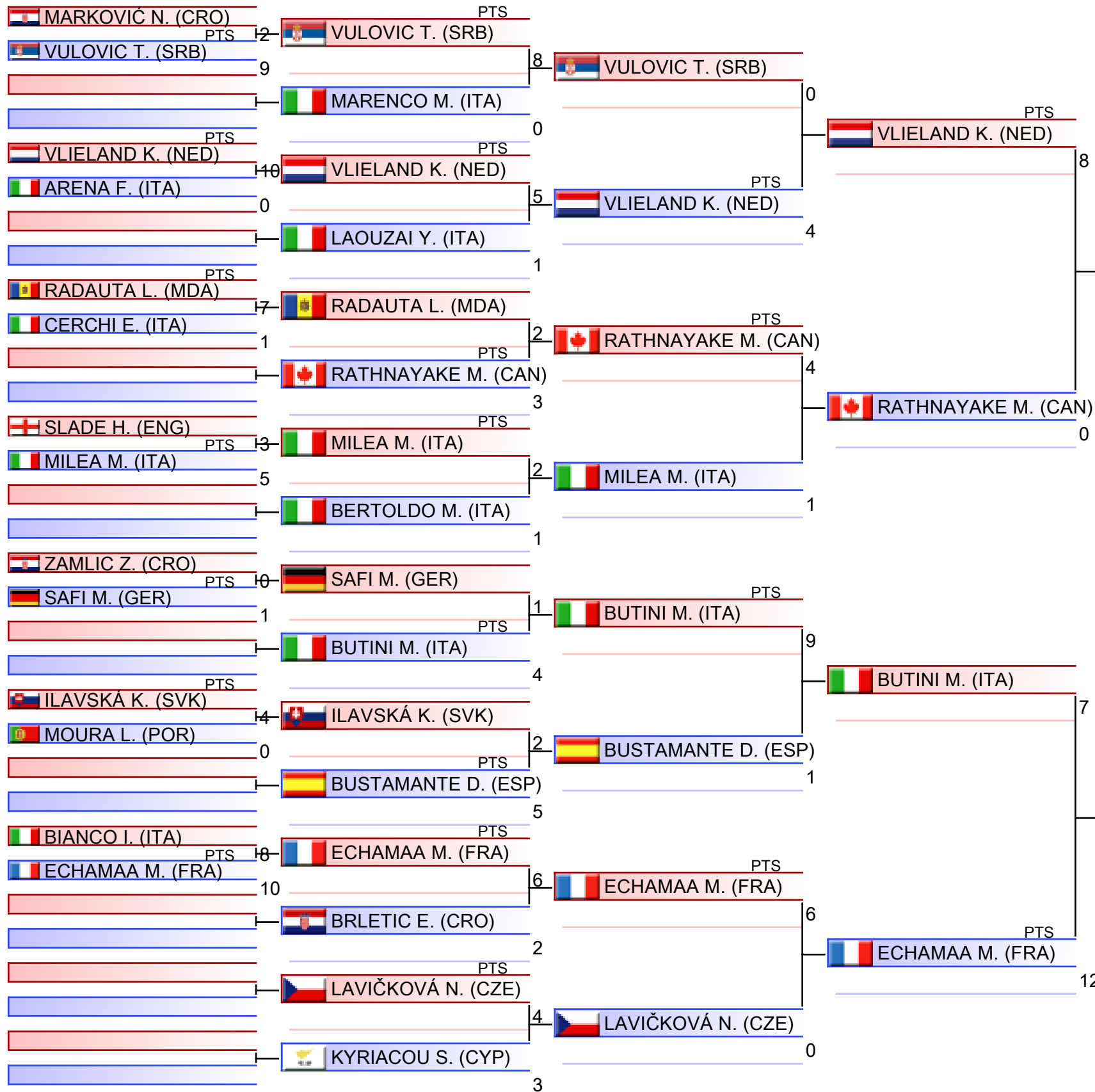

1. GONCALVES LEONOR (POR)
2. SCARFONE MORGANE (FRA)
3. ECHAMAA MARYAM (FRA)
3. SULU KARINA MIHAELA (ROU)
5. ŠETA ZEJNEB (BIH)
5. BALANESCU IOANA (ROU)
7. SELLITTI ANNA (ITA)
7. MILETA MARE (CRO)

Cadet Kumite Female -54 kg

Karate1 Youth League - Venice 2024, PALAZZO DEL TURISMO, Piazza Brescia 11, 30016 Lido di Jesolo VE, ITA

2024-12-07

Tatami
6 13:10

Pool
2/4

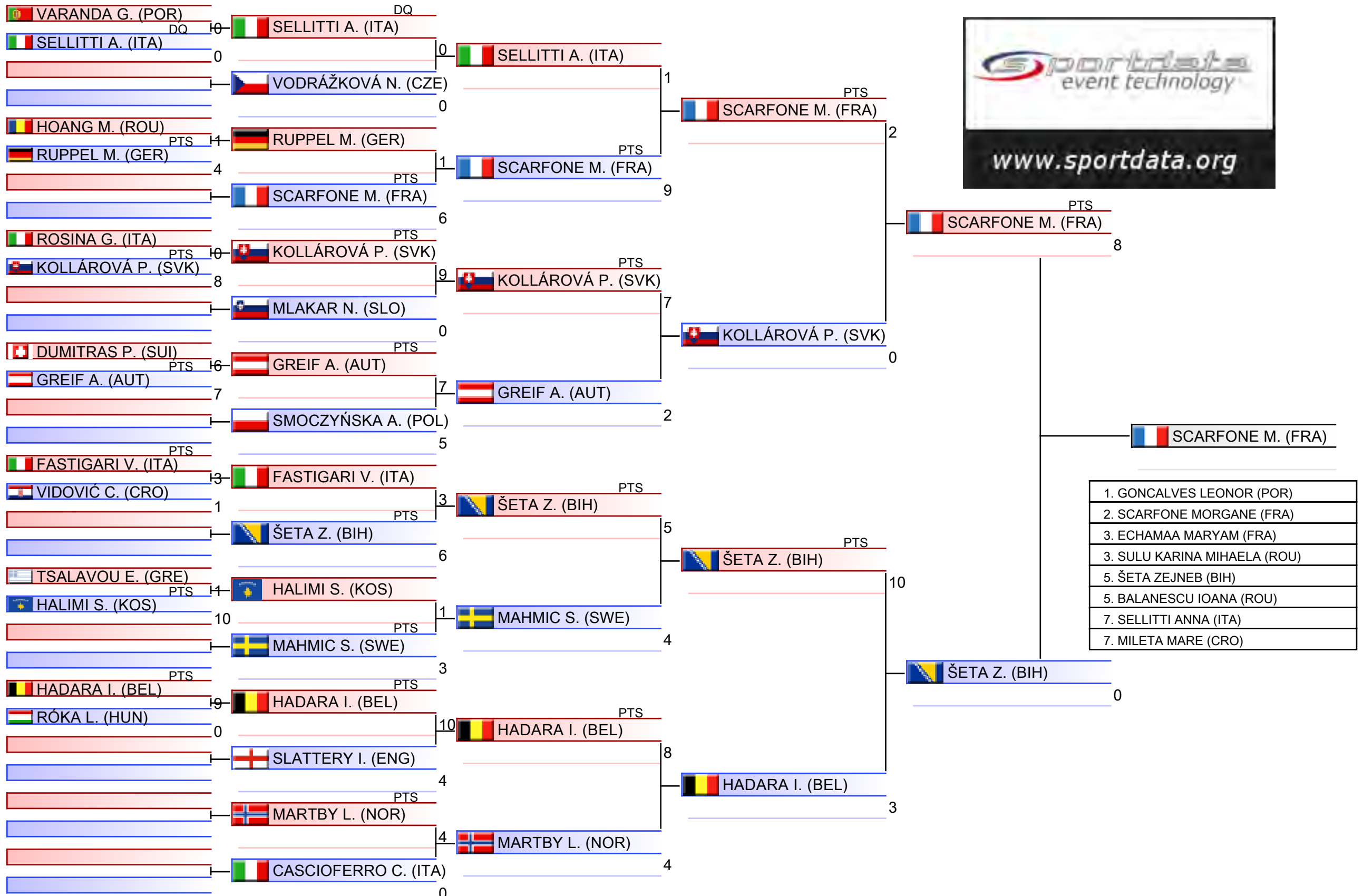

Cadet Kumite Female -54 kg

Karate1 Youth League - Venice 2024, PALAZZO DEL TURISMO, Piazza Brescia 11, 30016 Lido di Jesolo VE, ITA

2024-12-07

Tatami
7 13:10

Pool
3/4

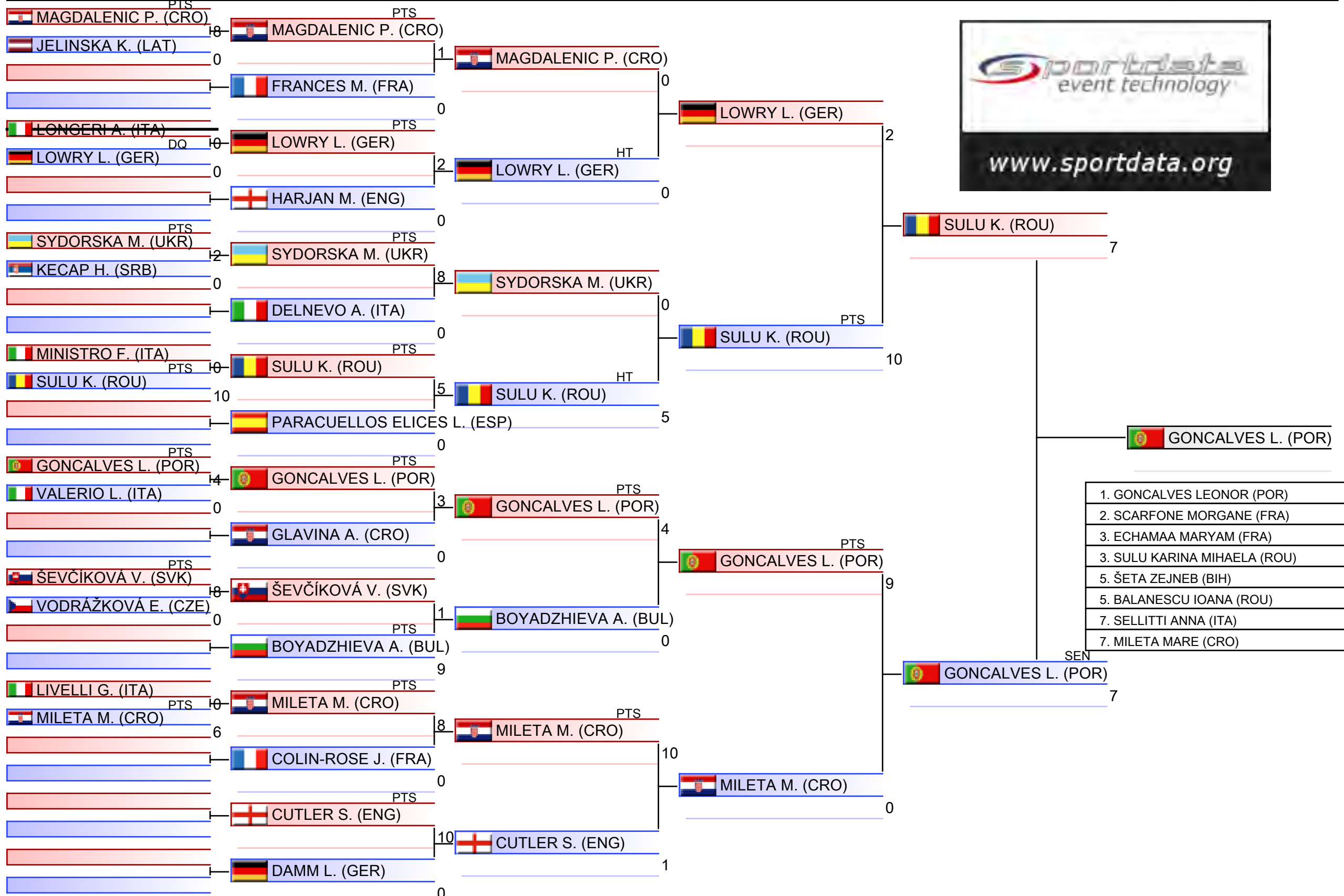

1.	GONCALVES LEONOR (POR)
2.	SCARFONE MORGANE (FRA)
3.	ECHAMAA MARYAM (FRA)
3.	SULU KARINA MIHAELA (ROU)
5.	ŠETA ZEJNEB (BIH)
5.	BALANESCU IOANA (ROU)
7.	SELLITTI ANNA (ITA)
7.	MILETA MARE (CRO)

Cadet Kumite Female -54 kg

Karate1 Youth League - Venice 2024, PALAZZO DEL TURISMO, Piazza Brescia 11, 30016 Lido di Jesolo VE, ITA

2024-12-07

Tatami
8 13:10

Pool
4/4

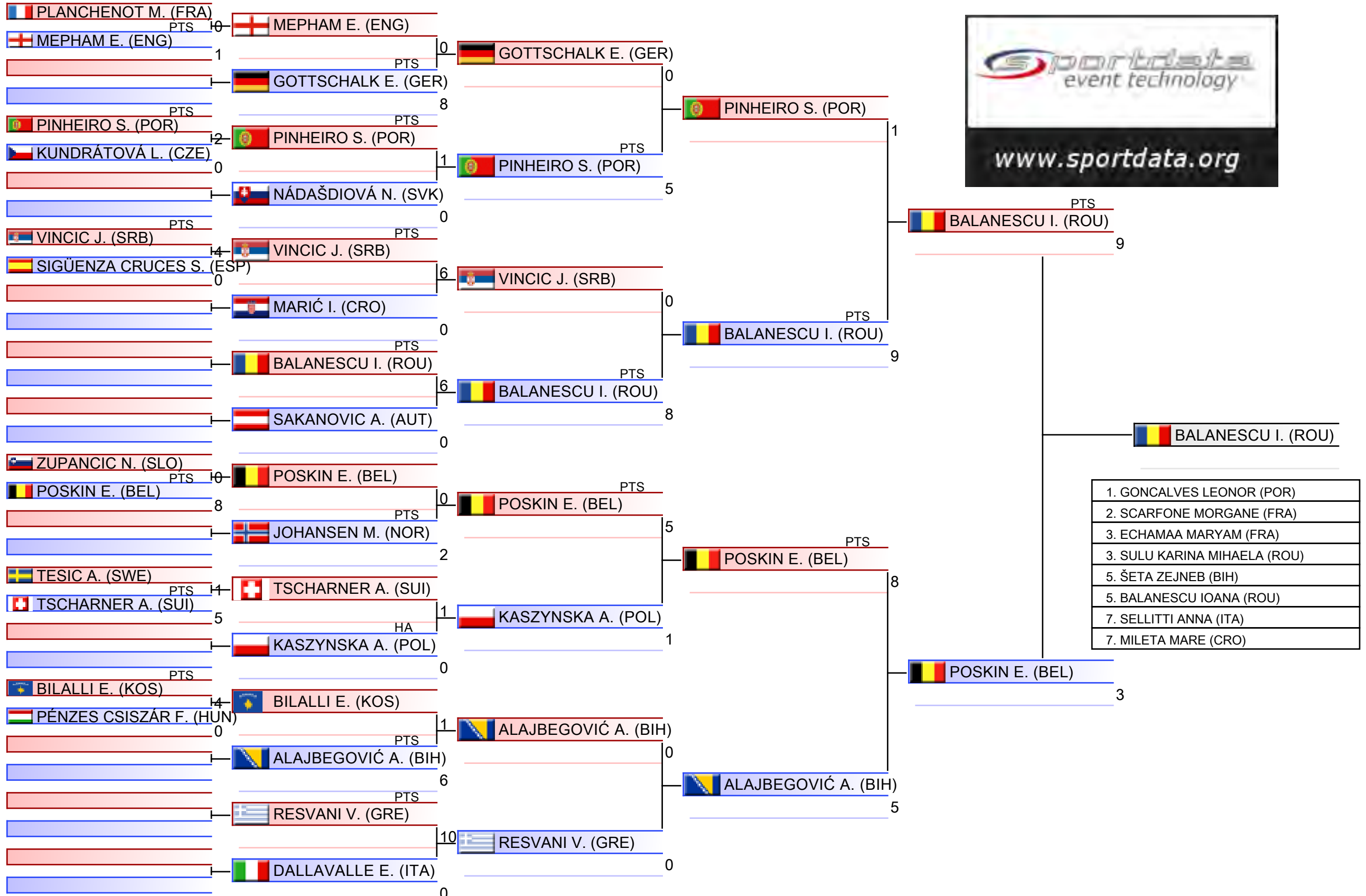

Pool winner-Cadet Kumite Female -54 kg

Karate1 Youth League - Venice 2024, PALAZZO DEL TURISMO, Piazza Brescia 11, 30016 Lido di Jesolo VE, ITA

2024-12-07

Tatami
5 15:10

Pool
1/1

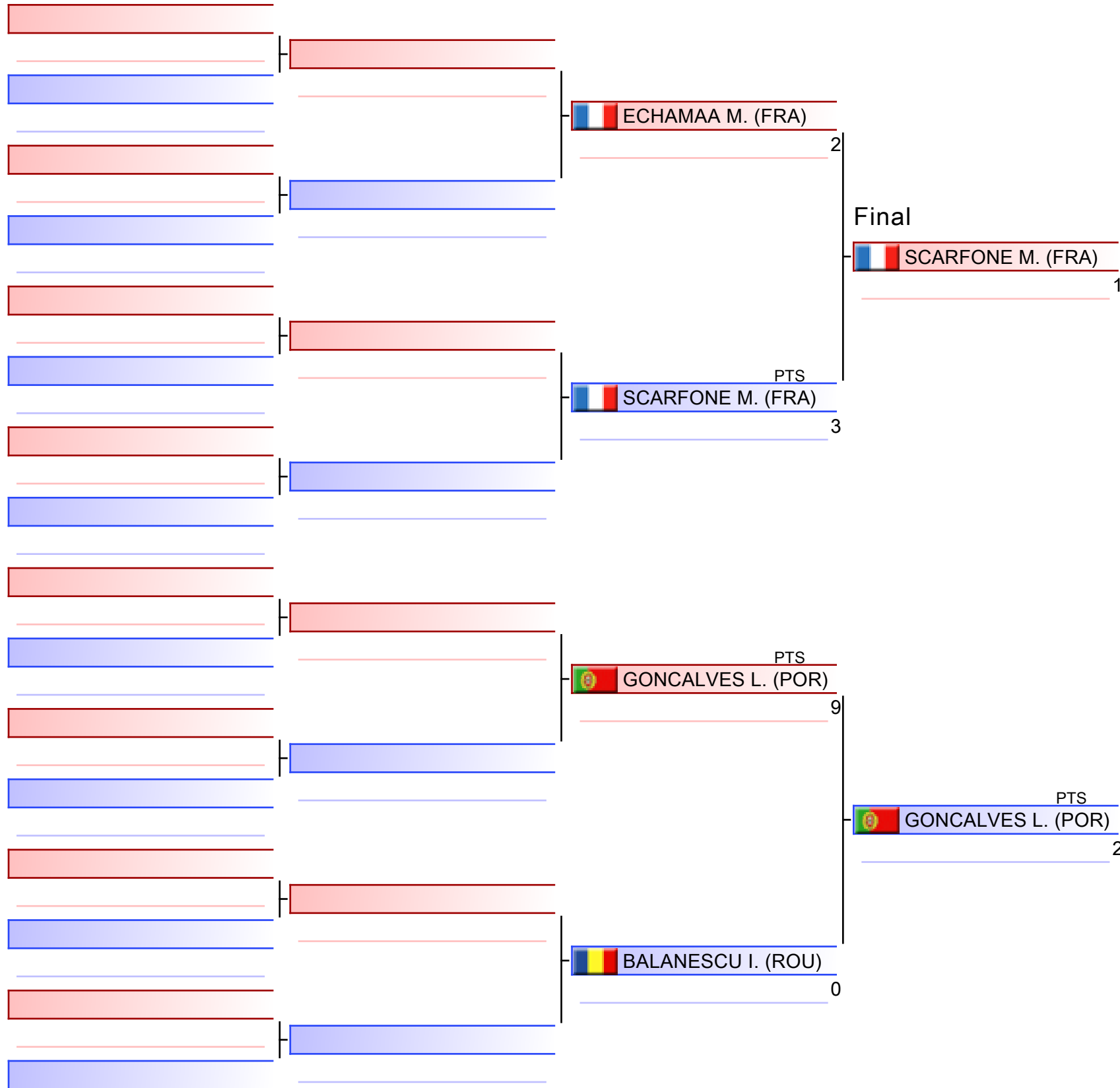

GONCALVES L. (POR)

1. GONCALVES LEONOR (POR)
2. SCARFONE MORGANE (FRA)
3. ECHAMAA MARYAM (FRA)
3. SULU KARINA MIHAELA (ROU)
5. ŠETA ZEJNEB (BIH)
5. BALANESCU IOANA (ROU)
7. SELLITTI ANNA (ITA)
7. MILETA MARE (CRO)

Cadet Kumite Female -54 kg

Karate1 Youth League - Venice 2024

2024-12-07

Tatami

5 19:05

Pool

4,1,2,3

(c)sportdata GmbH & Co KG 2000-2024 (2024-12-08 20:16) v 10.2.0 build 1 (2024-11-20 00:58 CET) License: SDIL TVG (expire 2025-01-26)

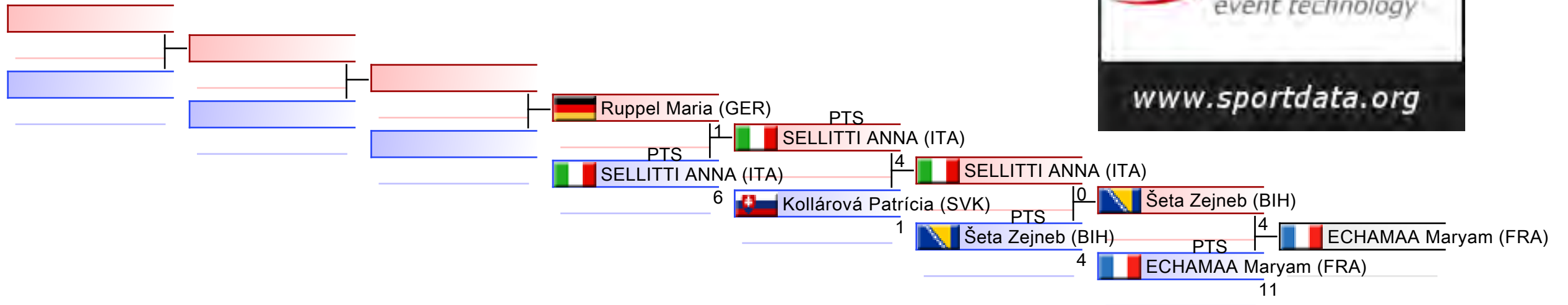

REPECHAGE: (4,1,2,3)

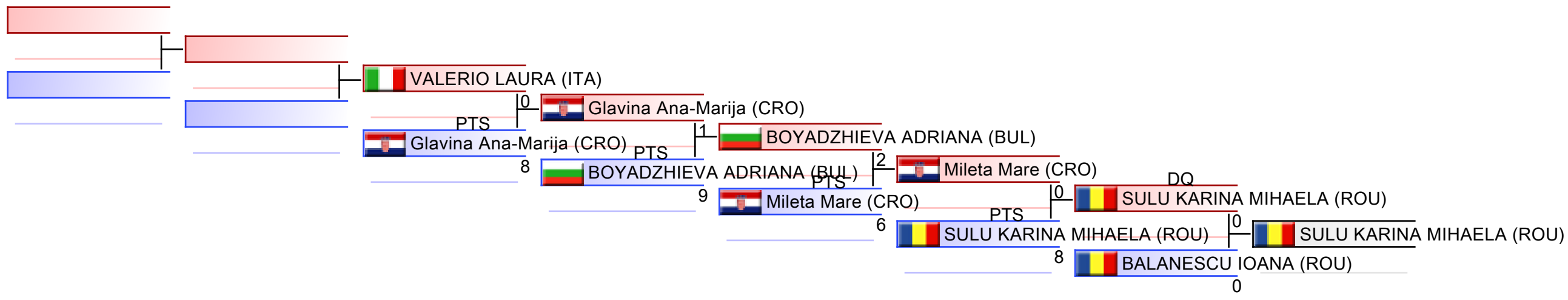



Karate1 Youth League - Venice 2024 - 2024-12-04



Official Results

Cadet Kumite Female -54 kg (Entries: 91 Nations: 29)			
1	GONCALVES LEONOR		POR - PORTUGAL
2	SCARFONE MORGANE		FRA - FRANCE
3	ECHAMAA MARYAM		FRA - FRANCE
3	SULU KARINA MIHAELA		ROU - ROMANIA
5	ŠETA ZEJNEB		BIH - BOSNIA AND HERZEGOVINA
5	BALANESCU IOANA		ROU - ROMANIA
7	SELLITTI ANNA		ITA - ITALY
7	MILETA MARE		CRO - CROATIA
9	KOLLÁROVÁ PATRÍCIA		SVK - SLOVAKIA
9	BOYADZHIEVA ADRIANA		BUL - BULGARIA
11	RUPPEL MARIA		GER - GERMANY
11	GLAVINA ANA-MARIJA		CRO - CROATIA
13	VALERIO LAURA		ITA - ITALY

CADET KUMITE FEMALE -61 KG



Karate1 Youth League - Venice 2024

ENTRIES BY WEIGHT CATEGORY



Cadet Kumite Female -61 kg

As of 8 DEC 2024

Country Code	ID	Gender	Name	Seeding
AUT	AUT02966	F	KOVACEVIC LEONI	
BEL		F	Rejraji Yasmine	
BIH		F	Aščić Šejla	
BIH		F	Fatušić Emina	
BIH		F	Husić Dalal	
BIH		F	Ikanovic Sarah	
BIH		F	Nižol Lana	
BIH		F	Pašić Mela	
BUL		F	ABULIBDE AMIRA	
BUL		F	Ivanova Tsvetelina	
BUL		F	Tseryanova Gabriela	
CRO		F	Buinac Tea	
CRO		F	Ćorić Lea	
CRO		F	Czerny Guščić Noa	
CRO		F	Fana Era	
CRO	CRO03048	F	KARLOVIC NOELI	
CRO	CRO03588	F	PANIC PAULA	
CRO		F	Rančić Paola	
ENG		F	Attard Sophie	
ENG		F	Belkadi Joumana	
ENG		F	Berry Lauren	
ENG		F	Blake Kiana	
ENG		F	Hitchcock Freya	
ENG		F	Nyoni Orianna	
ESP		F	NASARRE SÁNCHEZ AROA	
ESP		F	RODRÍGUEZ MARTÍNEZ ARIADNA	
ESP		F	SKIBA BIRKELBACH AMELIE YAIZA	
FRA		F	Barbieux Tess	
FRA	SD71749	F	YORO Eden	
GER		F	Flemming Johanna-Helene	
GER		F	Gündüz Ceylin-Nida	
GER	GER03639	F	KOENIG LIV SVENDE	
GER		F	Mattys Melina	
GER		F	Meißner Elisabeth	
GER		F	Pyvovarova Kateryna	
GER		F	Schneider Anna-Marie	
GER		F	Susnica Mila Marija	
GRE	GRE03003747	F	EVGENIADOU MELINA MARIA	
GRE	GRE003947	F	INGLESI ELEFThERIA THEODOSIA	
GRE	GRE02920	F	PAGONIDOU ATHANASIA	
HUN		F	Jakab Eszter Abigél	
HUN		F	Perényi Aida	
IRI		F	Pourzangeneh Taraneh	
IRI		F	Soltani Dehnavi Hasti	
ITA		F	Amabili Aurora	



Karate1 Youth League - Venice 2024

ENTRIES BY WEIGHT CATEGORY



Cadet Kumite Female -61 kg

As of 8 DEC 2024

Country Code	ID	Gender	Name	Seeding
ITA		F	belcastro gaia	
ITA		F	Bon Greta	
ITA		F	Disarò Ginevra	
ITA		F	Di Leo Noemi	
ITA		F	Di stefano Lavinia	
ITA		F	DOCIMO SARA	
ITA		F	Girello Alessandra	
ITA		F	Guarino Giulia	
ITA		F	GULOTTA GIOIA MARIA	
ITA		F	Musso Roberta	
ITA		F	Perandria Matilde	
ITA		F	ROSSANO FEDERICA CARMELA	
ITA		F	VETTORETTI GIADA	
ITA		F	zabska nicole	
KOS	KOS03061	F	AHMETI ELMA	
KOS	KOS02937	F	REXHEPI LANIKA	
KOS	KOS03301	F	SYLEJMANI EZANA	
LUX	LUX02432	F	De Rubeis Giulia	
NED	NED03277	F	Jong de Anniek	
NOR		F	Brenne Linnes Lea	
POL	POL08643	F	BIELSKA PAULINA	
POL	POL08641	F	DOMIAN MAJA	
POL	POL11963	F	Kapica Zuzanna	
POL	POL3867	F	KRACZAJ WIKTORIA	
POL	POL2910	F	PRZYBYLEK JULIA	
POR	POR03183	F	BAZYUK VICTORIA	
POR		F	Castro Beatriz	
POR		F	Fernandes Mariana	
POR		F	OLiveira Sara	
ROU	ROU03759	F	CURCA MARIA	
ROU	ROU003957	F	MARA IONESCU	
ROU	ROU03596	F	MICLEA NATALIA	
ROU	ROU003837	F	RAISA ENACHE	
ROU	ROU03747	F	STEFAN SOFIA NICOLA	
ROU	ROU03745	F	VOICU AMALIA IOANA	
SCO		F	Duff Julia	
SLO	SLO02690	F	KRVINA LIA	
SUI		F	Mühlemann Noemi	
SUI		F	Sanneh Fatumata	
SVK		F	Benešová Nina	
SVK		F	Breznanova Michaela	
SVK		F	Gášpárová Jessica	
SVK		F	Zelmanová Alzbeta	
UKR		F	Toderash Oleksandra	

Cadet Kumite Female -61 kg

Karate1 Youth League - Venice 2024, PALAZZO DEL TURISMO, Piazza Brescia 11, 30016 Lido di Jesolo VE, ITA

2024-12-07

Tatami
1 16:25

Pool
1/4

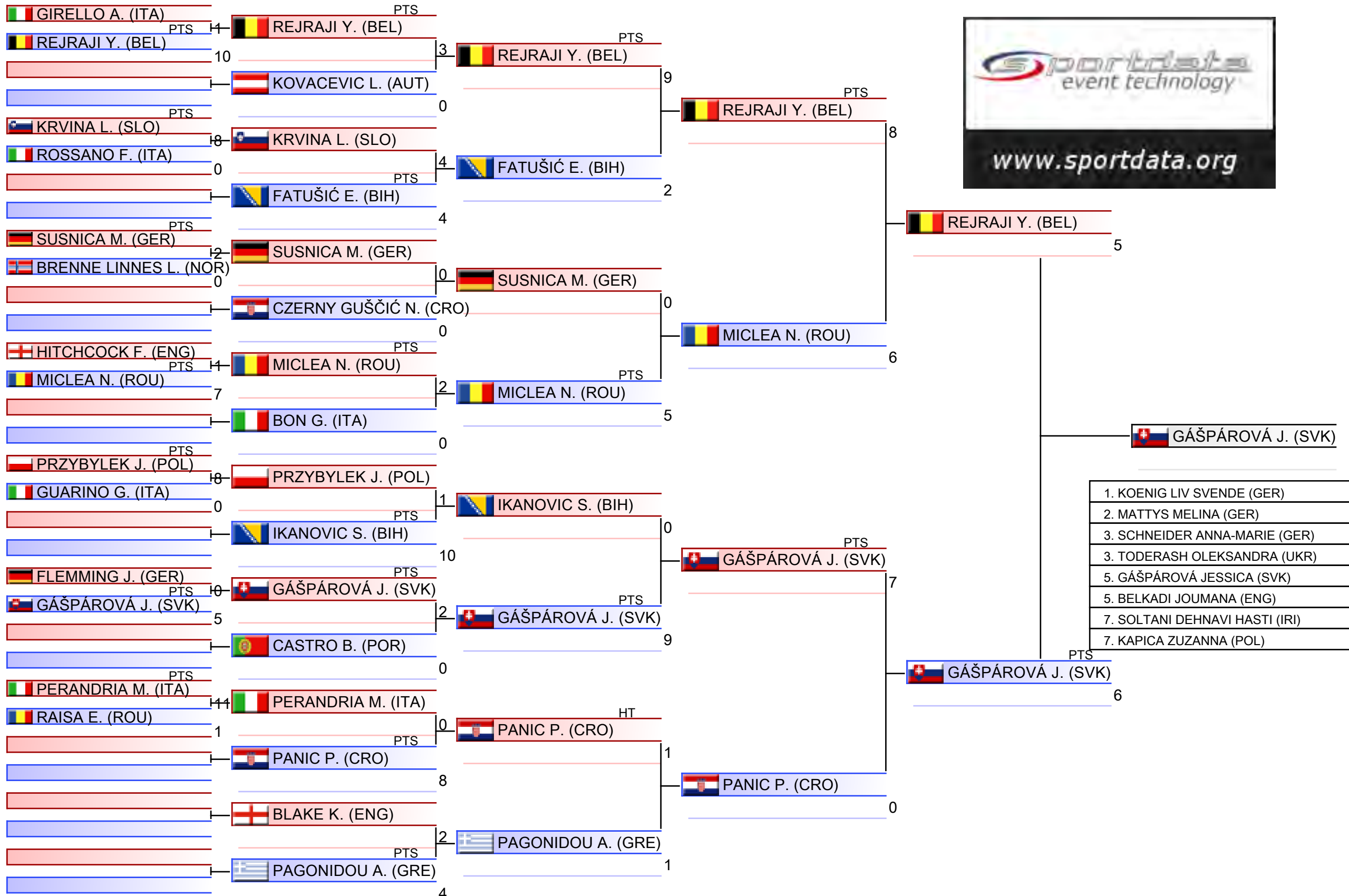

1.	KOENIG LIV SVENDE (GER)
2.	MATTYS MELINA (GER)
3.	SCHNEIDER ANNA-MARIE (GER)
3.	TODERASH OLEKSANDRA (UKR)
5.	GÁŠPÁROVÁ JESSICA (SVK)
5.	BELKADI JOUMANA (ENG)
7.	SOLTANI DEHNAVI HASTI (IRI)
7.	KAPICA ZUZANNA (POL)

Cadet Kumite Female -61 kg

Karate1 Youth League - Venice 2024, PALAZZO DEL TURISMO, Piazza Brescia 11, 30016 Lido di Jesolo VE, ITA

2024-12-07

Tatami
2 16:25

Pool
2/4

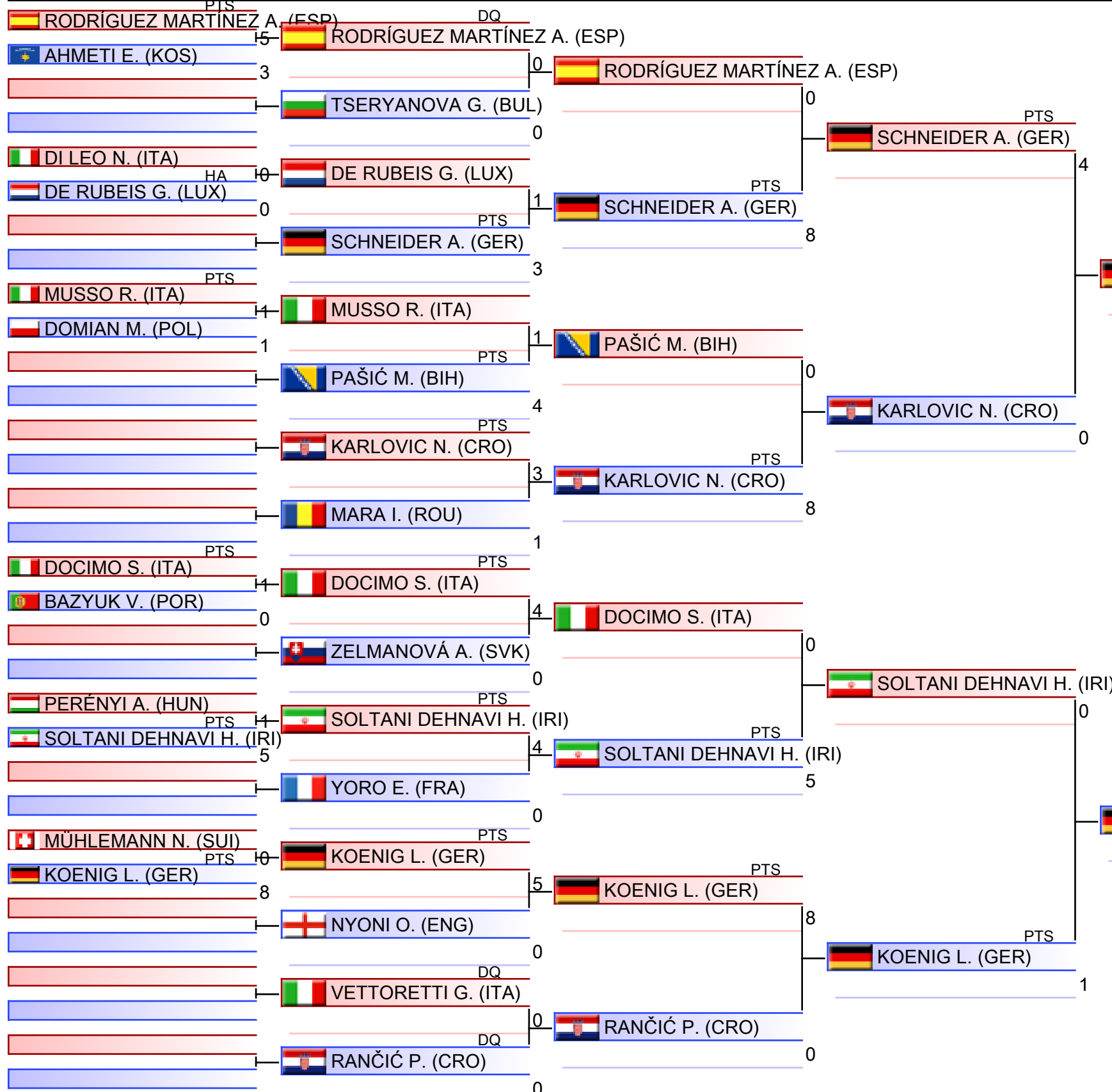

1. KOENIG LIV SVENDE (GER)
2. MATTYS MELINA (GER)
3. SCHNEIDER ANNA-MARIE (GER)
3. TODERASH OLEKSANDRA (UKR)
5. GÁŠPÁROVÁ JESSICA (SVK)
5. BELKADI JOUMANA (ENG)
7. SOLTANI DEHNAVI HASTI (IRI)
7. KAPICA ZUZANNA (POL)

Cadet Kumite Female -61 kg

Karate1 Youth League - Venice 2024, PALAZZO DEL TURISMO, Piazza Brescia 11, 30016 Lido di Jesolo VE, ITA

2024-12-07

Tatami
3 16:25

Pool
3/4

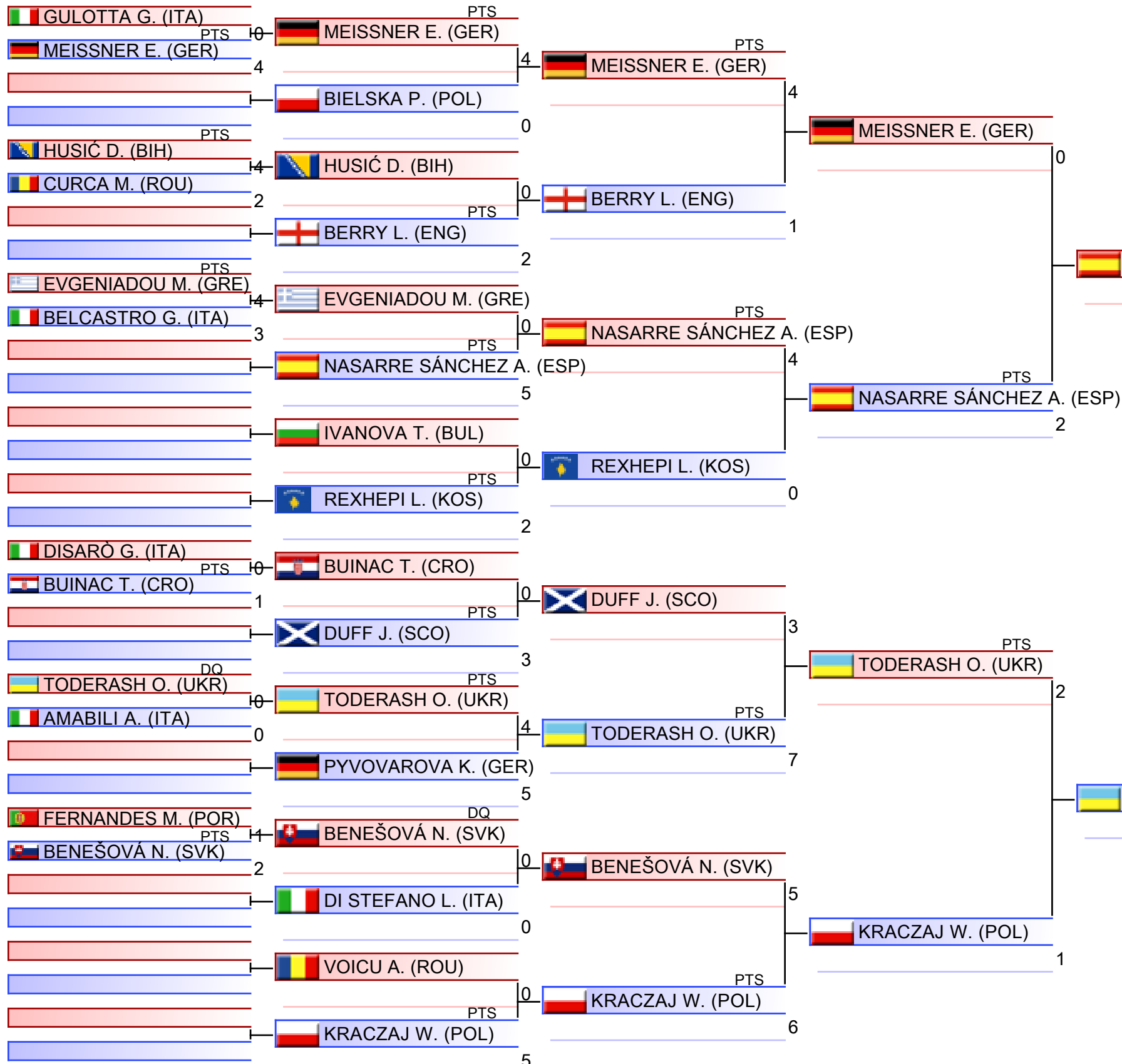

1.	KOENIG LIV SVENDE (GER)
2.	MATTYS MELINA (GER)
3.	SCHNEIDER ANNA-MARIE (GER)
3.	TODERASH OLEKSANDRA (UKR)
5.	GÁŠPÁROVÁ JESSICA (SVK)
5.	BELKADI JOUMANA (ENG)
7.	SOLTANI DEHNAVI HASTI (IRI)
7.	KAPICA ZUZANNA (POL)

Cadet Kumite Female -61 kg

Karate1 Youth League - Venice 2024, PALAZZO DEL TURISMO, Piazza Brescia 11, 30016 Lido di Jesolo VE, ITA

2024-12-07

Tatami
4 16:25

Pool
4/4

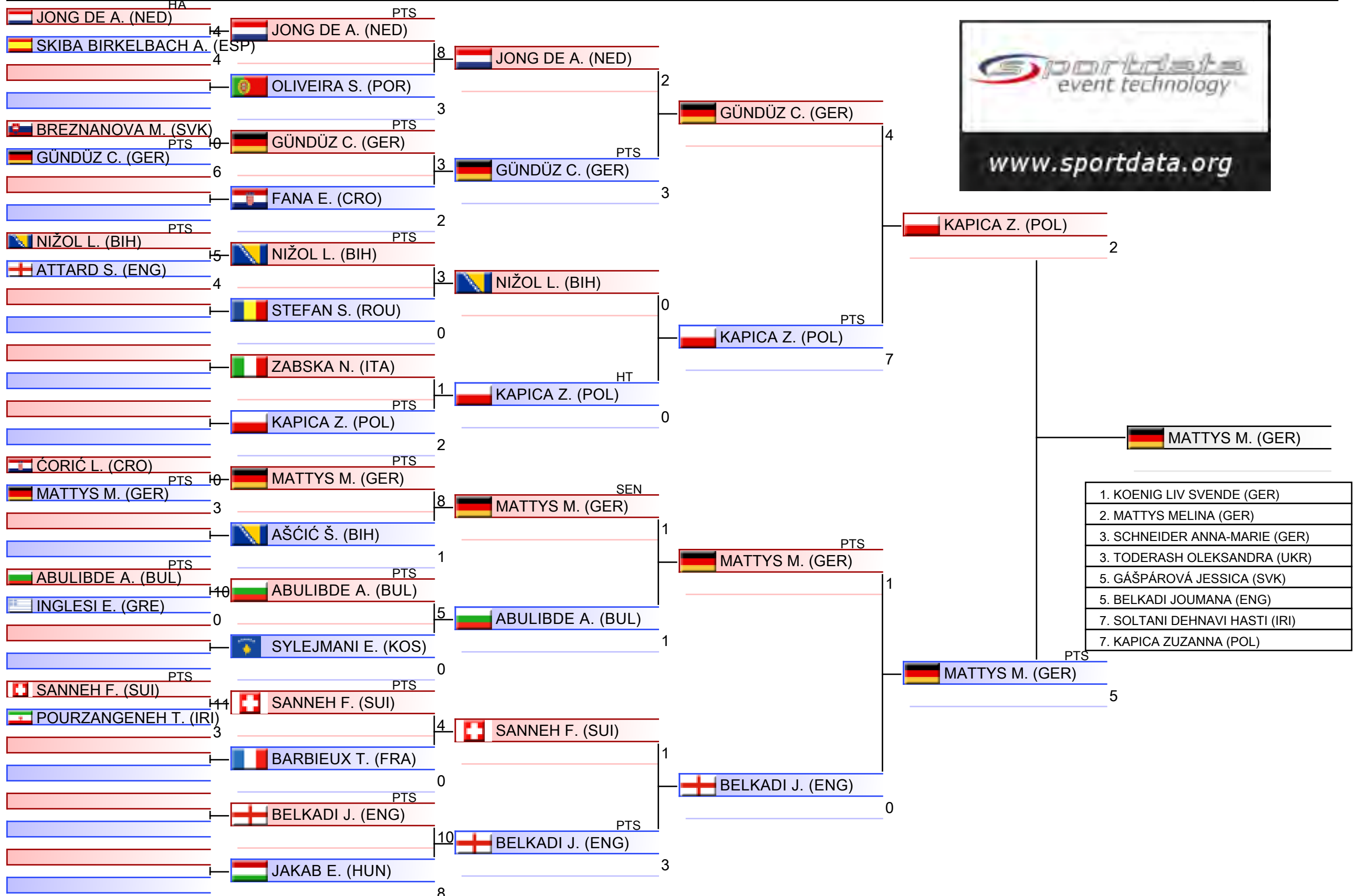

1. KOENIG LIV SVENDE (GER)
2. MATTYS MELINA (GER)
3. SCHNEIDER ANNA-MARIE (GER)
3. TODERASH OLEKSANDRA (UKR)
5. GAŠPÁROVÁ JESSICA (SVK)
5. BELKADI JOUMANA (ENG)
7. SOLTANI DEHNAVI HASTI (IRI)
7. KAPICA ZUZANNA (POL)

Pool winner-Cadet Kumite Female -61 kg

Karate1 Youth League - Venice 2024, PALAZZO DEL TURISMO, Piazza Brescia 11, 30016 Lido di Jesolo VE, ITA

2024-12-07

Tatami
1 18:20

Pool
1/1

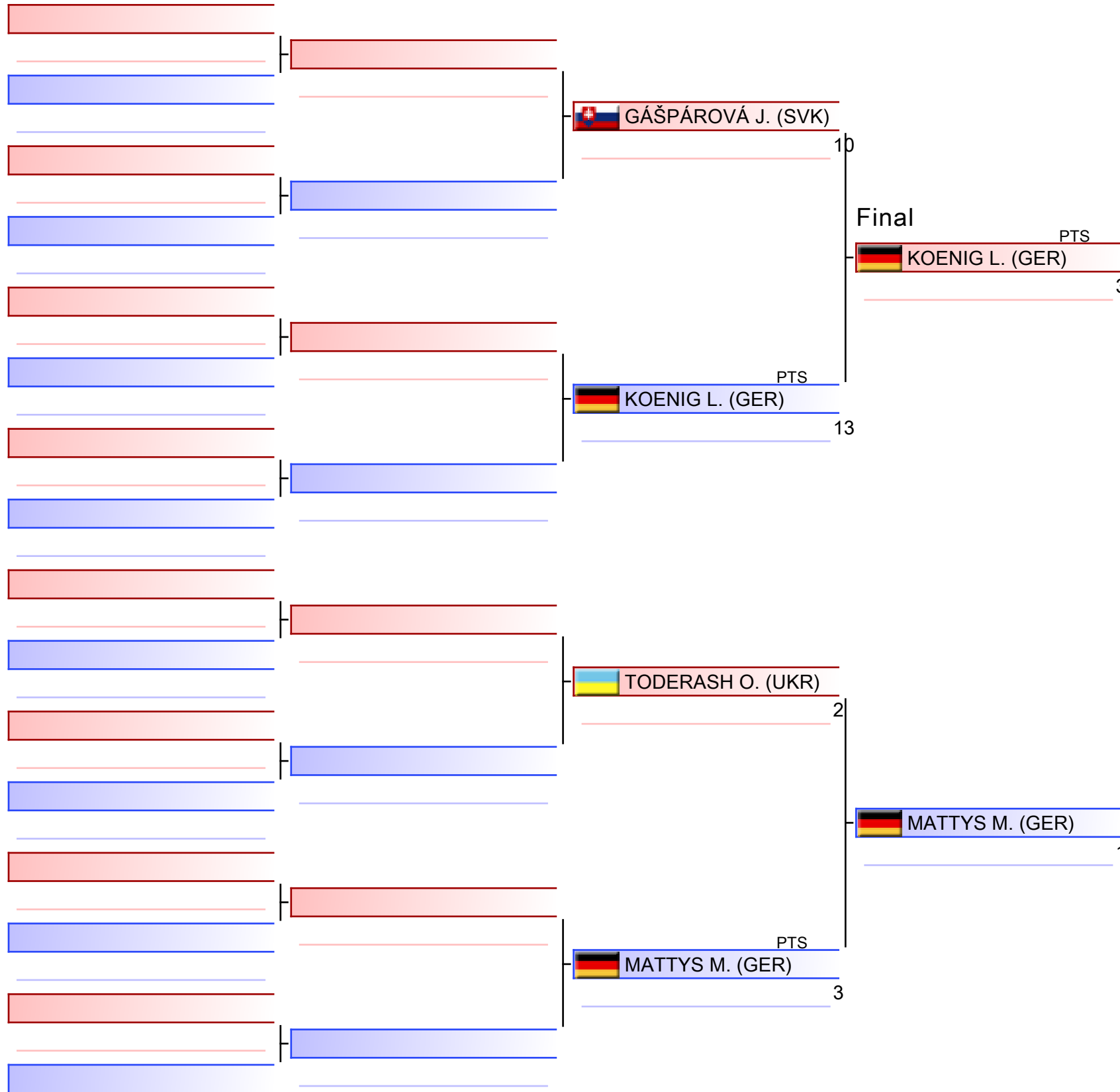

KOENIG L. (GER)

1. KOENIG LIV SVENDE (GER)
2. MATTYS MELINA (GER)
3. SCHNEIDER ANNA-MARIE (GER)
3. TODERASH OLEKSANDRA (UKR)
5. GÁŠPÁROVÁ JESSICA (SVK)
5. BELKADI JOUMANA (ENG)
7. SOLTANI DEHNAVI HASTI (IRI)
7. KAPICA ZUZANNA (POL)

Cadet Kumite Female -61 kg

Karate1 Youth League - Venice 2024

2024-12-07

Tatami

7 19:05

Pool

1,2,3,4

(c)sportdata GmbH & Co KG 2000-2024 (2024-12-08 20:16) v 10.2.0 build 1 (2024-11-20 00:58 CET) License: SDIL TVG (expire 2025-01-26)

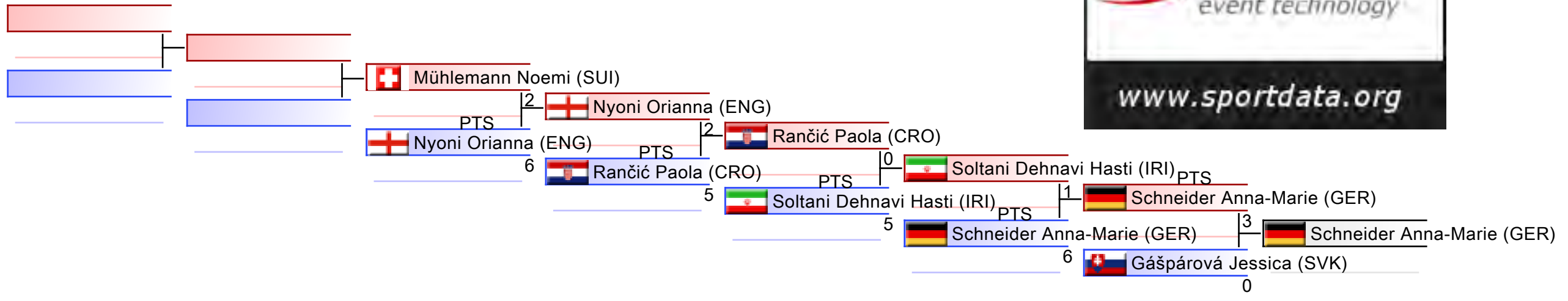

REPECHAGE: (1,2,3,4)

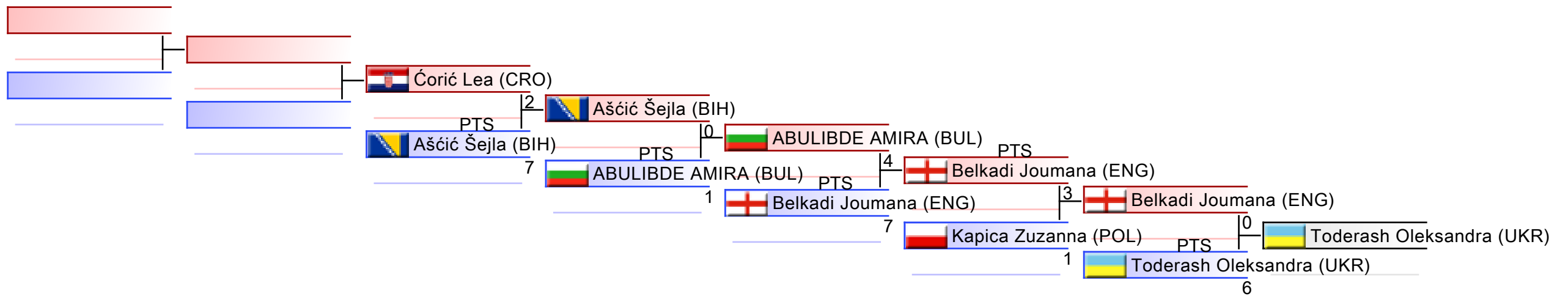



Karate1 Youth League - Venice 2024 - 2024-12-04



Official Results

Cadet Kumite Female -61 kg (Entries: 89 Nations: 25)			
1	KOENIG LIV SVENDE		GER - GERMANY
2	MATTYS MELINA		GER - GERMANY
3	SCHNEIDER ANNA-MARIE		GER - GERMANY
3	TODERASH OLEKSANDRA		UKR - UKRAINE
5	GÁSPÁROVÁ JESSICA		SVK - SLOVAKIA
5	BELKADI JOUMANA		ENG - ENGLAND
7	SOLTANI DEHNAVI HASTI		IRI - ISLAMIC REPUBLIC OF IRAN
7	KAPICA ZUZANNA		POL - POLAND
9	RANČIĆ PAOLA		CRO - CROATIA
9	ABULIBDE AMIRA		BUL - BULGARIA
11	NYONI ORIANNA		ENG - ENGLAND
11	AŠČIĆ ŠEJLA		BIH - BOSNIA AND HERZEGOVINA
13	MÜHLEMANN NOEMI		SUI - SWITZERLAND
13	CORIĆ LEA		CRO - CROATIA

CADET KUMITE FEMALE 61+ KG



Karate1 Youth League - Venice 2024

ENTRIES BY WEIGHT CATEGORY



Cadet Kumite Female 61+ kg

As of 8 DEC 2024

Country Code	ID	Gender	Name	Seeding
AUT	AUT02964	F	Bayram Ceylin	
AUT	AUT03005	F	KEMETINGER SARAH	
BEL		F	Sridi Maissa	
BIH		F	Bubalo Nahla	
BIH		F	Cokoja Mona	
BIH		F	Germic Arza	
BIH		F	Hodzic Ismihana	
BIH		F	Kurtanović Ajlin	
BIH		F	Matić Ena	
BIH		F	Muratović Dzejna	
BIH		F	Softić Ajna	
BUL		F	Dimitrova Daria	
CRO		F	Barukcic Ana Marie	
CRO	CRO03476	F	DORIC MEDINA	
CRO		F	Duduković Nina	
CRO		F	Krizman Lena	
CRO		F	Ledić Irma	
CRO		F	LESJAK TARA	
CRO	CRO03022	F	SIMUNDIC NIKA	
CZE	CZE002999	F	KREPSOVA KATKA	
CZE		F	Sekaninová Viktorie	
CZE		F	Suchá Dominika	
CZE		F	Troblová Silvie	
CZE		F	Vachtová Věra	
DEN		F	Andersen Emilie Hesselbech	
ENG		F	Walker Shamyra	
ESP		F	HERNANDEZ CASTILLA JULIA	
FRA		F	Doucare Célia	
FRA		F	Grisard Maëlyne	
GER		F	Bergmann Liya	
GER	SD75531	F	Gallert Lilli	
GER		F	Giegling Milena	
GER	GER03302	F	Gräfe Lotte	
GER		F	Heinrich Alina	
GER		F	Konradi Arwen	
GER		F	Lange Josephine	
GER		F	Nikolic Masa	
GER		F	Rausch Lisa	
GER	GER03305	F	SCHINDLER MILEY	
GER		F	Schopp Maksima	
GER		F	Strzemedłowska Martyna	
GER		F	Theobald Mia	
GRE		F	DOUKA EFFROSYNI - DAVIDOULA	
GRE		F	DOUKA VIOLETTA-FANOURIA	
GRE	GRE03516	F	FAGOGENI VASILIKI	



Karate1 Youth League - Venice 2024

ENTRIES BY WEIGHT CATEGORY



Cadet Kumite Female 61+ kg

As of 8 DEC 2024

Country Code	ID	Gender	Name	Seeding
HUN		F	Ádám Vivien	
HUN		F	Elgozali Aida	
HUN		F	Szebegyinszki Rita	
ITA		F	Agostini Matilde	
ITA		F	BALLABIO DELIA	
ITA		F	Banfi Azzurra	
ITA		F	Campisi Soumia	
ITA		F	Correddu Nicole	
ITA		F	De Vivo Annachiara	
ITA		F	Mazzotta Noemi	
ITA		F	ONORI Sofia	
ITA		F	PASIN MATILDE	
ITA		F	PIETRAMALA GRETA	
ITA		F	RICCIARDI ELISA	
ITA		F	ULINICI NICOLETA	
LAT		F	Kalēda Undīne	
LAT		F	Selavko Olga	
LAT		F	Spradziņa Arianna	
LAT		F	Upeniece Madara	
LUX		F	Pierantoni Nora	
POL	POL11248	F	Fertsch Natalia	
POR		F	Santos Madalena	
ROU	ROU03734	F	MACOVEI DIANA	
ROU	ROU03587	F	MIHALEA FLAVIA	
SCO	SCO02409	F	Ewing Maia	
SLO	SLO02701	F	BRACUN MASERA IRIS	
SLO	SLO03048	F	KRISTANCIC ZIVA	
SRB		F	Kolarevic Iva	
SRB		F	Miranovic Lara	
SRB		F	Popovic Sara	
SRB		F	Todorovic Iva	
SRB		F	Ugarak Andjelija	
SRB		F	Vulovic Marija	
SUI		F	Alari Susan	
SUI		F	Arifagic Almina	
SUI		F	Gibril Hiba	
SUI		F	Hermenier Norah	
SUI		F	Redzic Esma	
SVK	SVK003248	F	Kretovičová Rita	
UKR		F	Hontarenko Viktoriia	
UKR		F	Kossak Adriana	
UKR		F	SVENTYTSKA VERONIKA	
UKR	SD66568	F	Tahirova Maria	

Cadet Kumite Female 61+ kg

Karate1 Youth League - Venice 2024, PALAZZO DEL TURISMO, Piazza Brescia 11, 30016 Lido di Jesolo VE, ITA

2024-12-07

Tatami
5 15:20

Pool
1/4

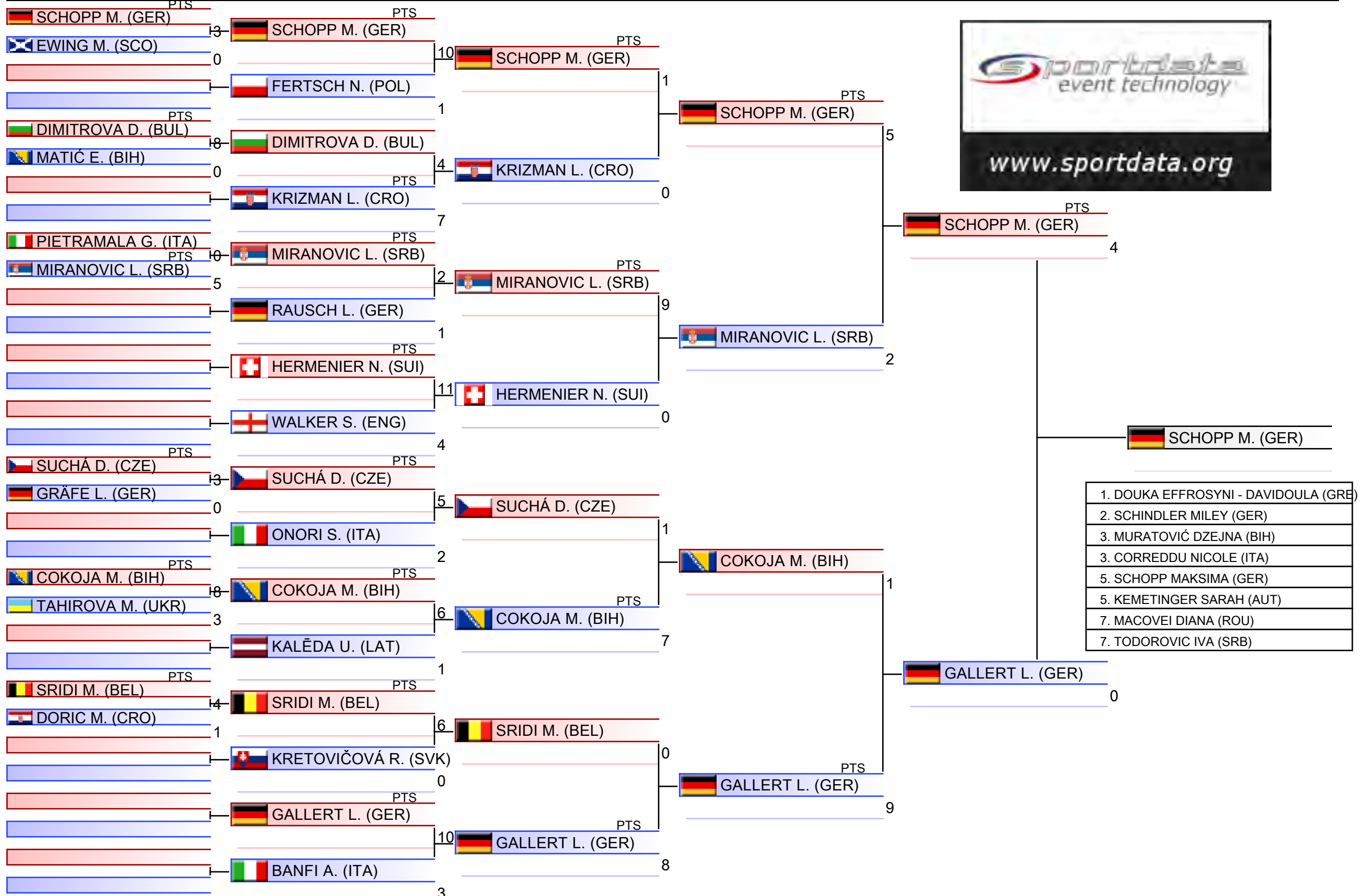

- | |
|--------------------------------------|
| 1. DOUKA EFFROSINI - DAVIDOULA (GRE) |
| 2. SCHINDLER MILEY (GER) |
| 3. MURATOVIĆ DZEJNA (BIH) |
| 3. CORREDDU NICOLE (ITA) |
| 5. SCHOPP MAKSIMA (GER) |
| 5. KEMETINGER SARAH (AUT) |
| 7. MACOVEI DIANA (ROU) |
| 7. TODOROVIC IVA (SRB) |

Cadet Kumite Female 61+ kg

Karate1 Youth League - Venice 2024, PALAZZO DEL TURISMO, Piazza Brescia 11, 30016 Lido di Jesolo VE, ITA

2024-12-07

Tatami
6 15:20

Pool
2/4

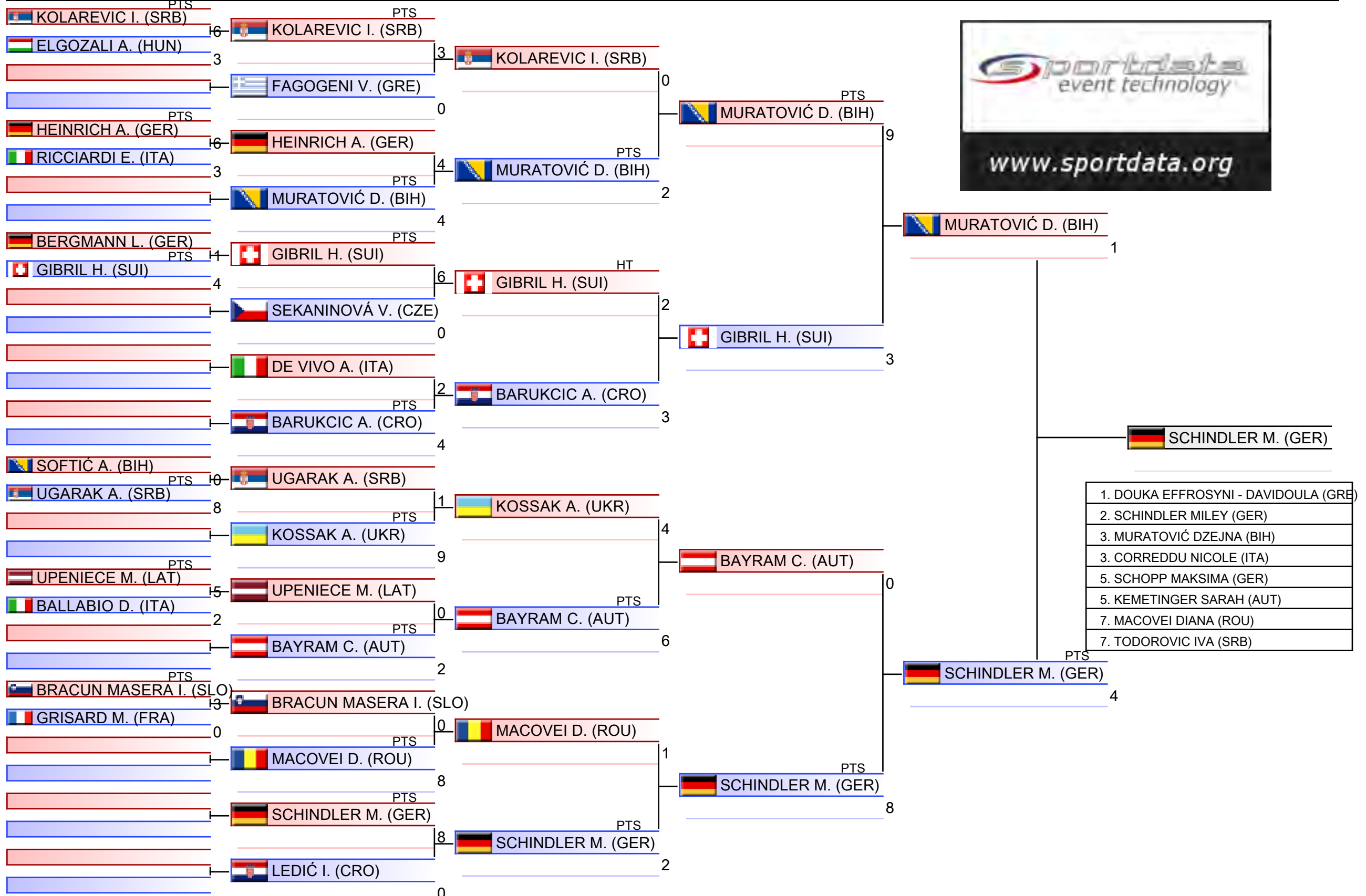

1.	DOUKA EFFROSINI - DAVIDOULA (GRE)
2.	SCHINDLER MILEY (GER)
3.	MURATOVIĆ DZEJNA (BIH)
3.	CORREDDU NICOLE (ITA)
5.	SCHOPP MAKSIMA (GER)
5.	KEMETINGER SARAH (AUT)
7.	MACOVEI DIANA (ROU)
7.	TODOROVIC IVA (SRB)

Cadet Kumite Female 61+ kg

Karate1 Youth League - Venice 2024, PALAZZO DEL TURISMO, Piazza Brescia 11, 30016 Lido di Jesolo VE, ITA

2024-12-07

Tatami
7 15:20

Pool
3/4

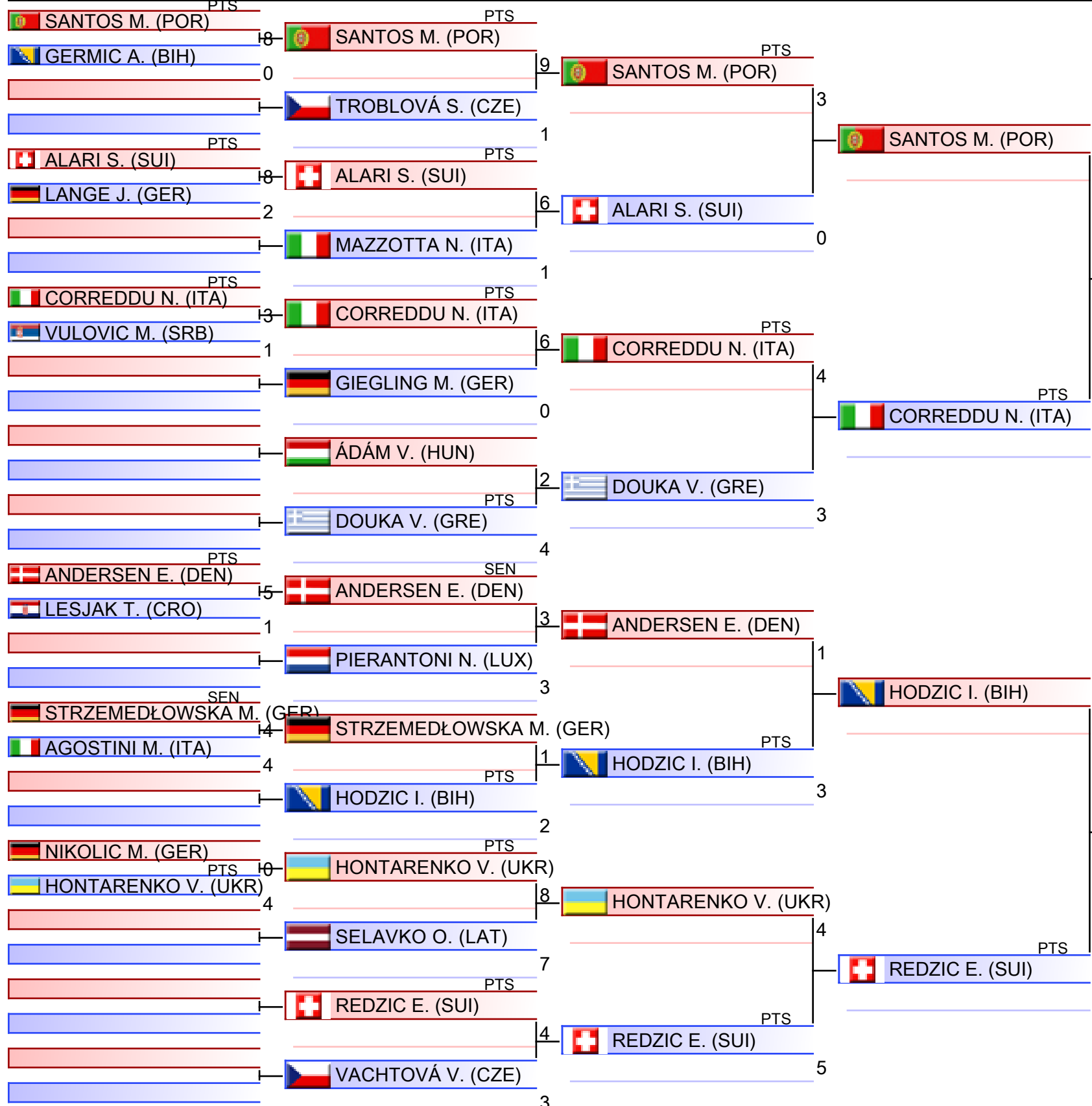

- | |
|--------------------------------------|
| 1. DOUKA EFFROSINI - DAVIDOULA (GRE) |
| 2. SCHINDLER MILEY (GER) |
| 3. MURATOVIĆ DZEJNA (BIH) |
| 3. CORREDDU NICOLE (ITA) |
| 5. SCHOPP MAKSIMA (GER) |
| 5. KEMETINGER SARAH (AUT) |
| 7. MACOVEI DIANA (ROU) |
| 7. TODOROVIC IVA (SRB) |

Cadet Kumite Female 61+ kg

Karate1 Youth League - Venice 2024, PALAZZO DEL TURISMO, Piazza Brescia 11, 30016 Lido di Jesolo VE, ITA

2024-12-07

Tatami
8 15:20

Pool
4/4

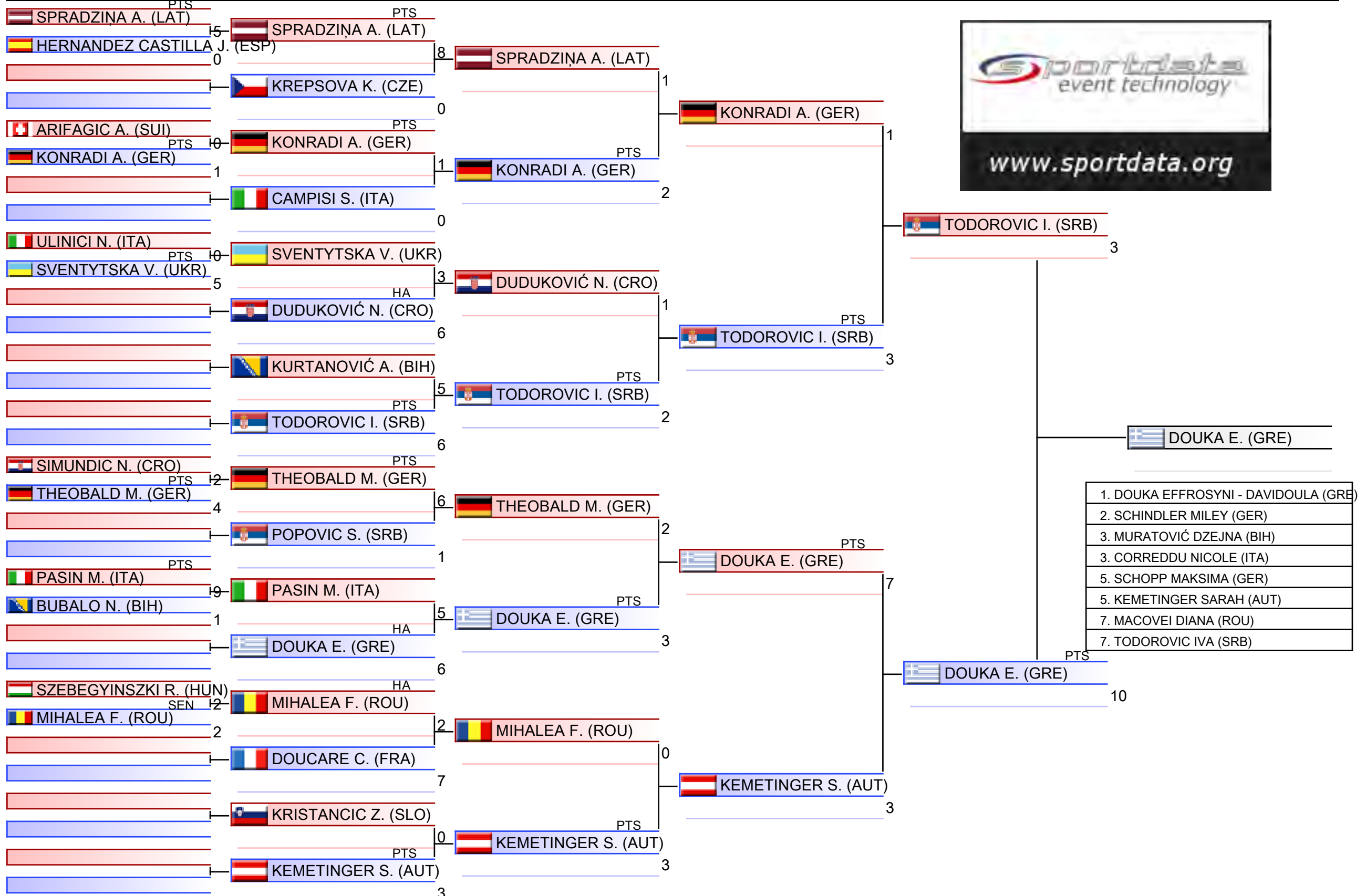

Pool winner-Cadet Kumite Female 61+ kg

Karate1 Youth League - Venice 2024, PALAZZO DEL TURISMO, Piazza Brescia 11, 30016 Lido di Jesolo VE, ITA

2024-12-07

Tatami
5 17:15

Pool
1/1

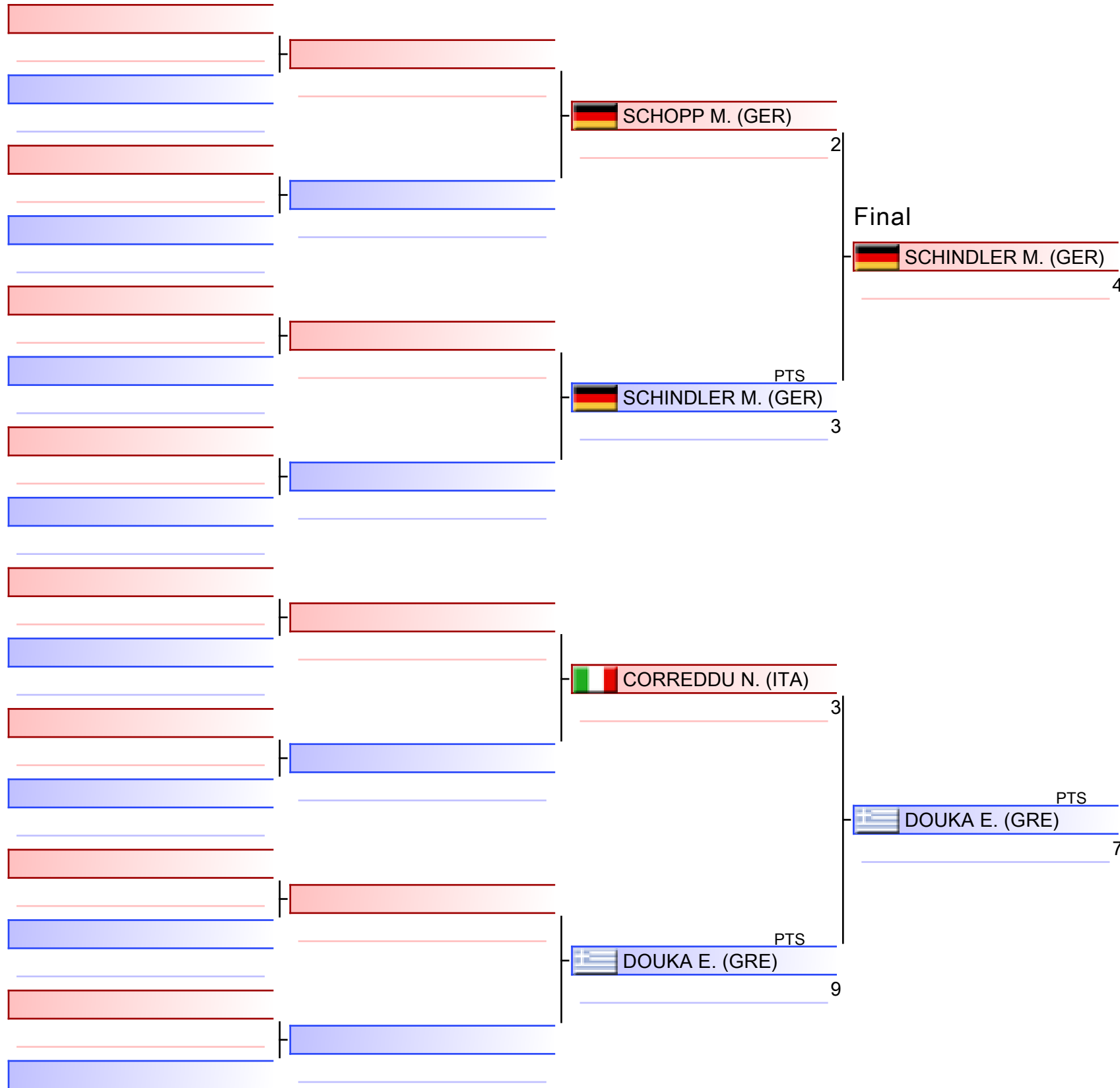

DOUKA E. (GRE)

1. DOUKA EFFROSYNI - DAVIDOULA (GRE)
2. SCHINDLER MILEY (GER)
3. MURATOVIĆ DZEJNA (BIH)
3. CORREDDU NICOLE (ITA)
5. SCHOPP MAKSIMA (GER)
5. KEMETINGER SARAH (AUT)
7. MACOVEI DIANA (ROU)
7. TODOROVIC IVA (SRB)

Cadet Kumite Female 61+ kg

Karate1 Youth League - Venice 2024

2024-12-07

Tatami
8 19:05

Pool
1,2,3,4

(c)sportdata GmbH & Co KG 2000-2024 (2024-12-08 20:16) v 10.2.0 build 1 (2024-11-20 00:58 CET) License: SDIL TVG (expire 2025-01-26)

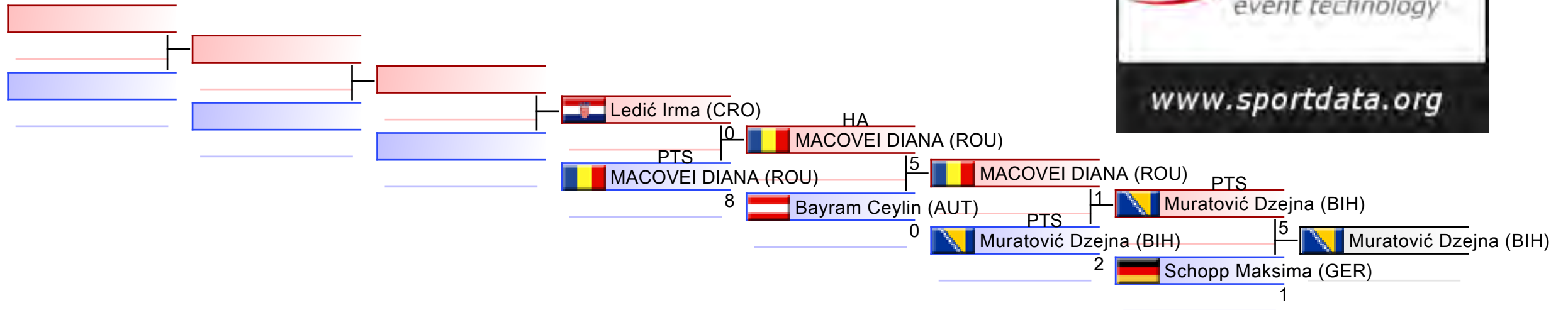

REPECHAGE: (1,2,3,4)

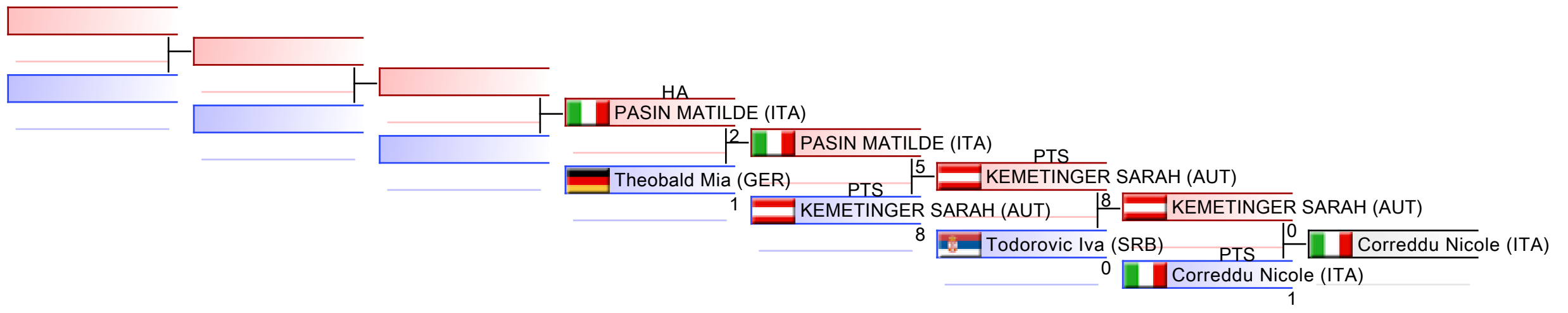



Karate1 Youth League - Venice 2024 - 2024-12-04



Official Results

Cadet Kumite Female 61+ kg (Entries: 88 Nations: 25)			
1	DOUKA EFFROSYNI - DAVIDOULA		GRE - GREECE
2	SCHINDLER MILEY		GER - GERMANY
3	MURATOVIĆ DZEJNA		BIH - BOSNIA AND HERZEGOVINA
3	CORREDDU NICOLE		ITA - ITALY
5	SCHOPP MAKSIMA		GER - GERMANY
5	KEMETINGER SARAH		AUT - AUSTRIA
7	MACOVEI DIANA		ROU - ROMANIA
7	TODOROVIC IVA		SRB - SERBIA
9	BAYRAM CEYLIN		AUT - AUSTRIA
9	PASIN MATILDE		ITA - ITALY
11	LEDIĆ IRMA		CRO - CROATIA
11	THEOBALD MIA		GER - GERMANY

CADET KUMITE MALE -52 KG



Karate1 Youth League - Venice 2024

ENTRIES BY WEIGHT CATEGORY



Cadet Kumite Male -52 kg

As of 8 DEC 2024

Country Code	ID	Gender	Name	Seeding
ARM	ARM02373	M	GRIGORYAN ALEN	
AZE	AZE003413	M	AHMADZADA ISMAYIL	
AZE	AZE02344	M	GANBAROV VUSAL	
BAN	BAN002622	M	CHOUDHURY MAHEEN ADAM	
BEL		M	Boscolo Nathan	
BEL		M	Hamoudane Hamza	
BEL		M	KONRADOWSKI ANDREAS	
BEL	SD56394	M	Roland Nathan	
BUL	BUL003048	M	TANEV IOAN	
CAN		M	MOKDAD MANAF	
CAN	CAN003871	M	SINGH EVAN	
CRO		M	Leskovar Sven	
CRO	CRO03463	M	PANIC TINO	
CRO	CRO03461	M	PAPONJA DAVID	
CZE		M	Olžbut Tomáš	
ENG		M	Jurgo Sigitas	
ENG		M	Patterson Thomas	
ENG		M	Voican Yanic	
ESP		M	Ayerdi Oihan	
ESP		M	Chaibi Soufian	
ESP		M	DOMINGUEZ PRIEGO JOSE MANUEL	
ESP		M	ORTIZ RUEDA JORGE	
ESP		M	PEREZ DE ANUZITA GARCÍA ORIOL	
FRA		M	Collin Maé	
FRA		M	SCARFONE Hugo	
GEO	GEO02813	M	DADESHKELIANI LEVANI	
GEO	GEO002911	M	KHATISASHVILI DAVIT	
GER	GER03355	M	Becker Yannik	
GER		M	Grünelt Oliver	
GER		M	Kalies Tom	
GER	GER003980	M	NAMYSLIK FELIX	
GER		M	Stauffenberg Friedolin	
GRE	GRE02635	M	FILIAGKOS ATHANASIOS	
GRE		M	PANTAZIS ATHANASIOS	
HUN		M	Albert Noé	
HUN		M	András István Tamási	
HUN		M	Gereben Ábel	
HUN		M	Szabolcs Pásztor	
HUN		M	Szócs Miksa	
HUN		M	Turányi Márton	
ITA		M	COPPOLA GAETANO PIO	
ITA		M	DE SIMONE ALESSIO	
ITA		M	DI MICHELE RAIN	
ITA		M	Di nardo Mattia	
ITA		M	Ferraris Giacomo	



Karate1 Youth League - Venice 2024

ENTRIES BY WEIGHT CATEGORY



Cadet Kumite Male -52 kg

As of 8 DEC 2024

Country Code	ID	Gender	Name	Seeding
ITA		M	Iacobacci Amedeo Junior	
ITA		M	LEGNAM ANGELO	
ITA	ITA483250	M	Lella Qian Yue Daniele	
ITA		M	Moffa Luigi	
ITA		M	Mura Matteo	
ITA		M	Privitera Antonino Pio	
ITA		M	SORCI SAMUELE	
ITA		M	Treggia Tommaso	
ITA		M	VACCA Matteo	
KOS	KOS02730	M	BERISHA FUAT	
LAT		M	Ivanovs Nikita	
LAT		M	Jeparskis Timurs	
LAT		M	Petersons Arsenijs	
LUX		M	Szekeres Maxim	
MDA	MDA02304	M	STAVARACHI RENAT	
NED	NED3034	M	Stoutjesdijk Aaron	
POL	POL07169	M	BORCHERT IGOR	
POL	POL06564	M	GBUREK WOJCIECH	
POL		M	Karabon Maksymilian	
POL	POL07992	M	WIECIECH DAWID	
POL	POL3560	M	ZYGANOWSKI JAKUB	
POR		M	Costa João Lencart	
POR		M	Costa Pedro Lencart	
POR		M	Ferreira Afonso	
POR		M	Franco Tomás	
POR		M	Palma Martim	
POR		M	Santos Gabriel	
ROU	ROU03592	M	IONASCU SEBASTIAN	
ROU	ROU03606	M	VAIA SEBASTIAN NICOLAE	
SCO		M	Craib James	
SRB		M	Horvat Todor	
SRB		M	Jovanović Vukašin	
SUI		M	Alfonso Perez Eloy	
SUI		M	Giaquinto Daniele	
SUI		M	Lüthy Corsin Dion	
SUI		M	Mateus Gomes Cristiano	
SUI		M	Mateus Gomes Leonardo	
SUI		M	Sengebusch Aaron	
SUI		M	Zecca Lucas	
SVK		M	Kompauer Maxim	
SVK		M	Koval David	
SWE		M	Mustafa Josef	
TKM	TKM02131	M	AMANDURDYEV GURBANNAZAR	
TKM	TKM02656	M	GURBANOV REMEZAN	
TKM	TKM02341	M	KISELYOV BOGDAN	



Karate1 Youth League - Venice 2024
ENTRIES BY WEIGHT CATEGORY



Cadet Kumite Male -52 kg
As of 8 DEC 2024

Country Code	ID	Gender	Name	Seeding
TUR		M	KIRAT YİĞİT	
UKR		M	Fomitskyi Ihor	
UKR		M	Ilchuk Savellii	
UKR		M	Trofimov Daniil	
UKR	UKR03559	M	VIECHKANOV MAKSYM	

Cadet Kumite Male -52 kg

Karate1 Youth League - Venice 2024, PALAZZO DEL TURISMO, Piazza Brescia 11, 30016 Lido di Jesolo VE, ITA

2024-12-07

Tatami
1 09:00

Pool
1/4

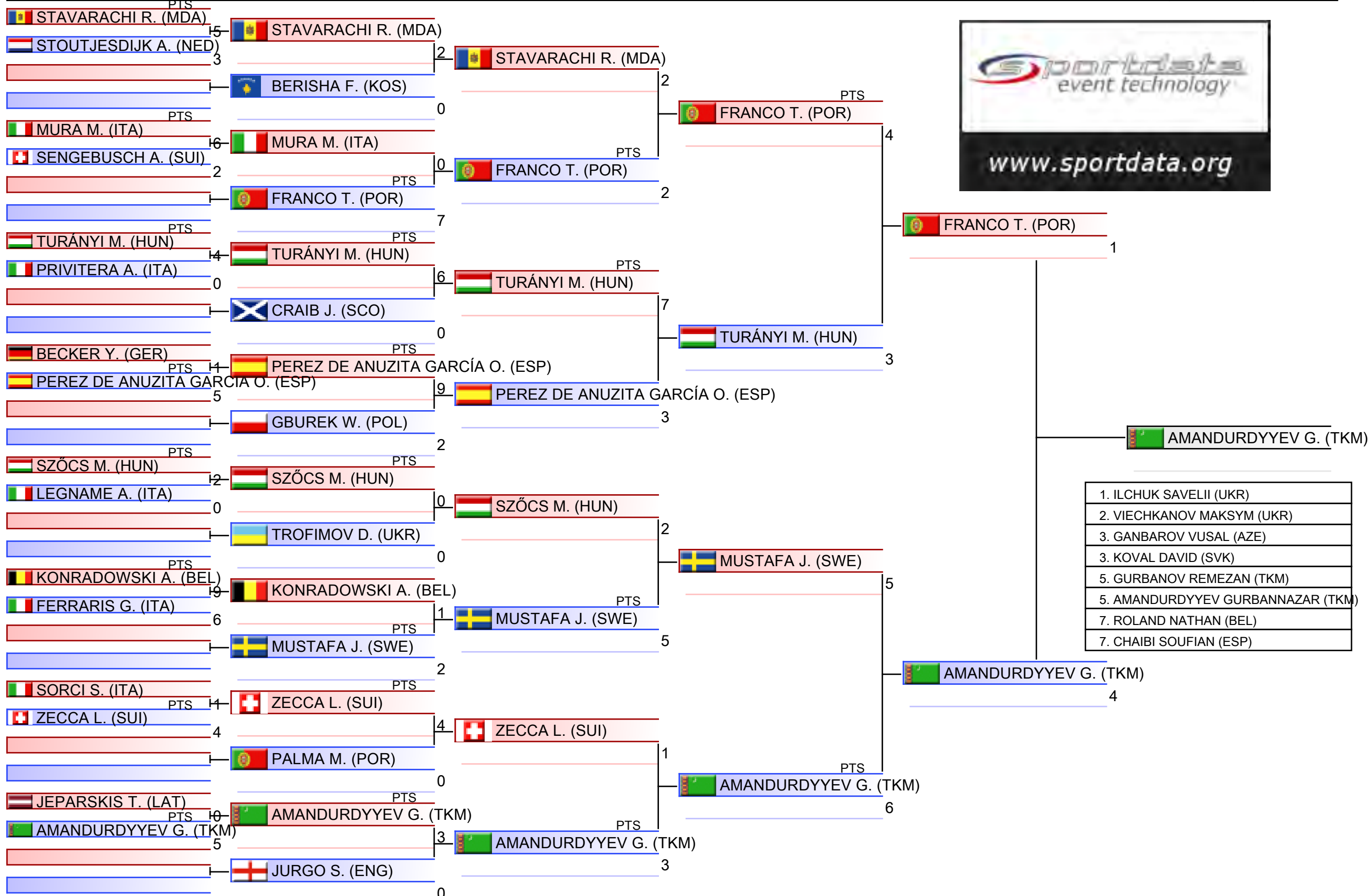

1. ILCHUK SAVELII (UKR)
2. VIECHKANOV MAKSYM (UKR)
3. GANBAROV VUSAL (AZE)
3. KOVAL DAVID (SVK)
5. GURBANOV REMEZAN (TKM)
5. AMANDURDYEV GURBANNAZAR (TKM)
7. ROLAND NATHAN (BEL)
7. CHAIBI SOUFIAN (ESP)

Cadet Kumite Male -52 kg

Karate1 Youth League - Venice 2024, PALAZZO DEL TURISMO, Piazza Brescia 11, 30016 Lido di Jesolo VE, ITA

2024-12-07

Tatami
2 09:00

Pool
2/4

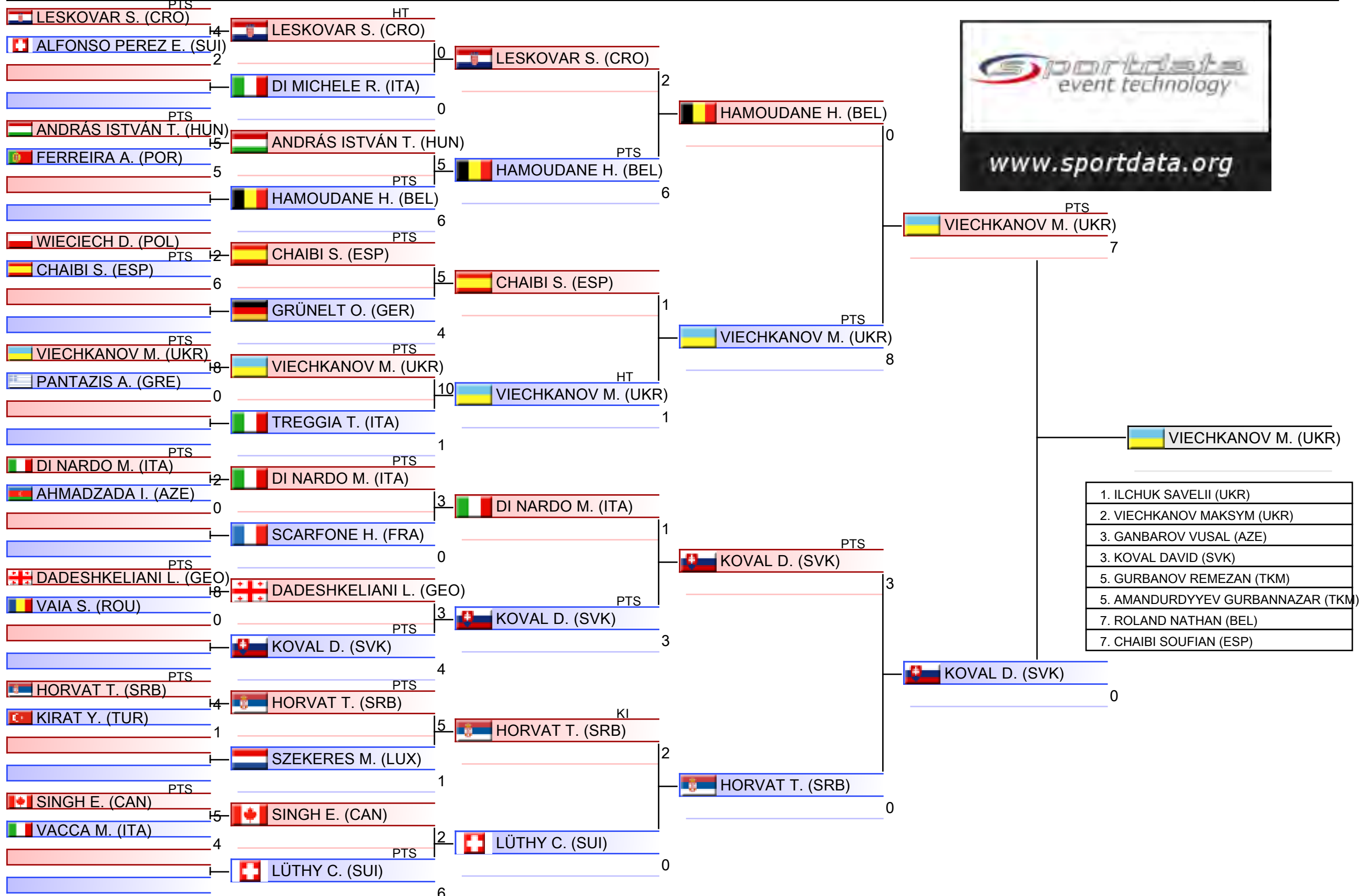

1. ILCHUK SAVELII (UKR)
2. VIECHKANOV MAKSYM (UKR)
3. GANBAROV VUSAL (AZE)
3. KOVAL DAVID (SVK)
5. GURBANOV REMEZAN (TKM)
5. AMANDURDYEV GURBANNAZAR (TKM)
7. ROLAND NATHAN (BEL)
7. CHAIBI SOUFIAN (ESP)

Cadet Kumite Male -52 kg

Karate1 Youth League - Venice 2024, PALAZZO DEL TURISMO, Piazza Brescia 11, 30016 Lido di Jesolo VE, ITA

2024-12-07

Tatami
3 09:00

Pool
3/4

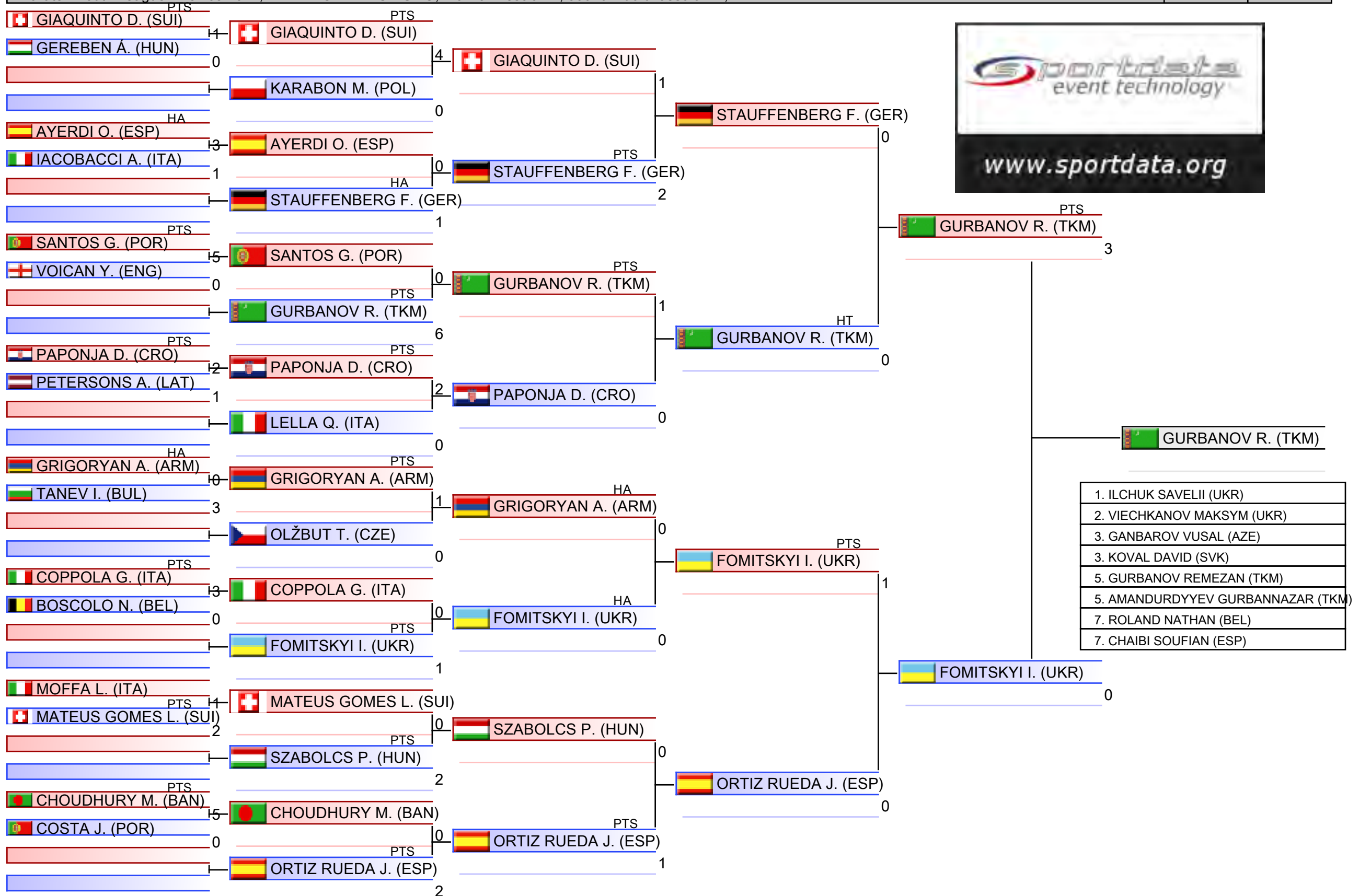

Cadet Kumite Male -52 kg

Karate1 Youth League - Venice 2024, PALAZZO DEL TURISMO, Piazza Brescia 11, 30016 Lido di Jesolo VE, ITA

2024-12-07

Tatami
4 09:00

Pool
4/4

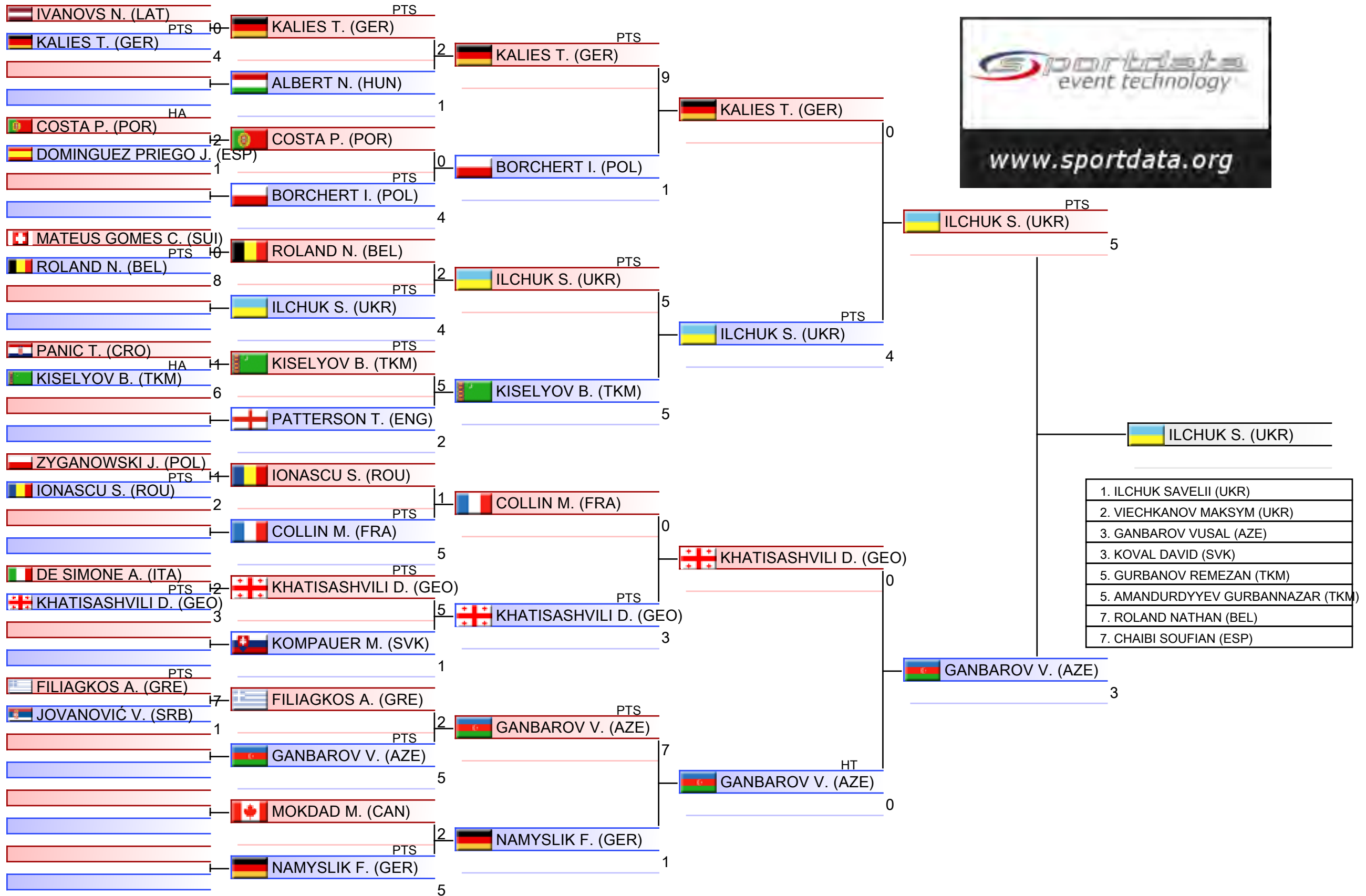

Pool winner-Cadet Kumite Male -52 kg

Karate1 Youth League - Venice 2024, PALAZZO DEL TURISMO, Piazza Brescia 11, 30016 Lido di Jesolo VE, ITA

2024-12-07

Tatami
1 11:05

Pool
1/1

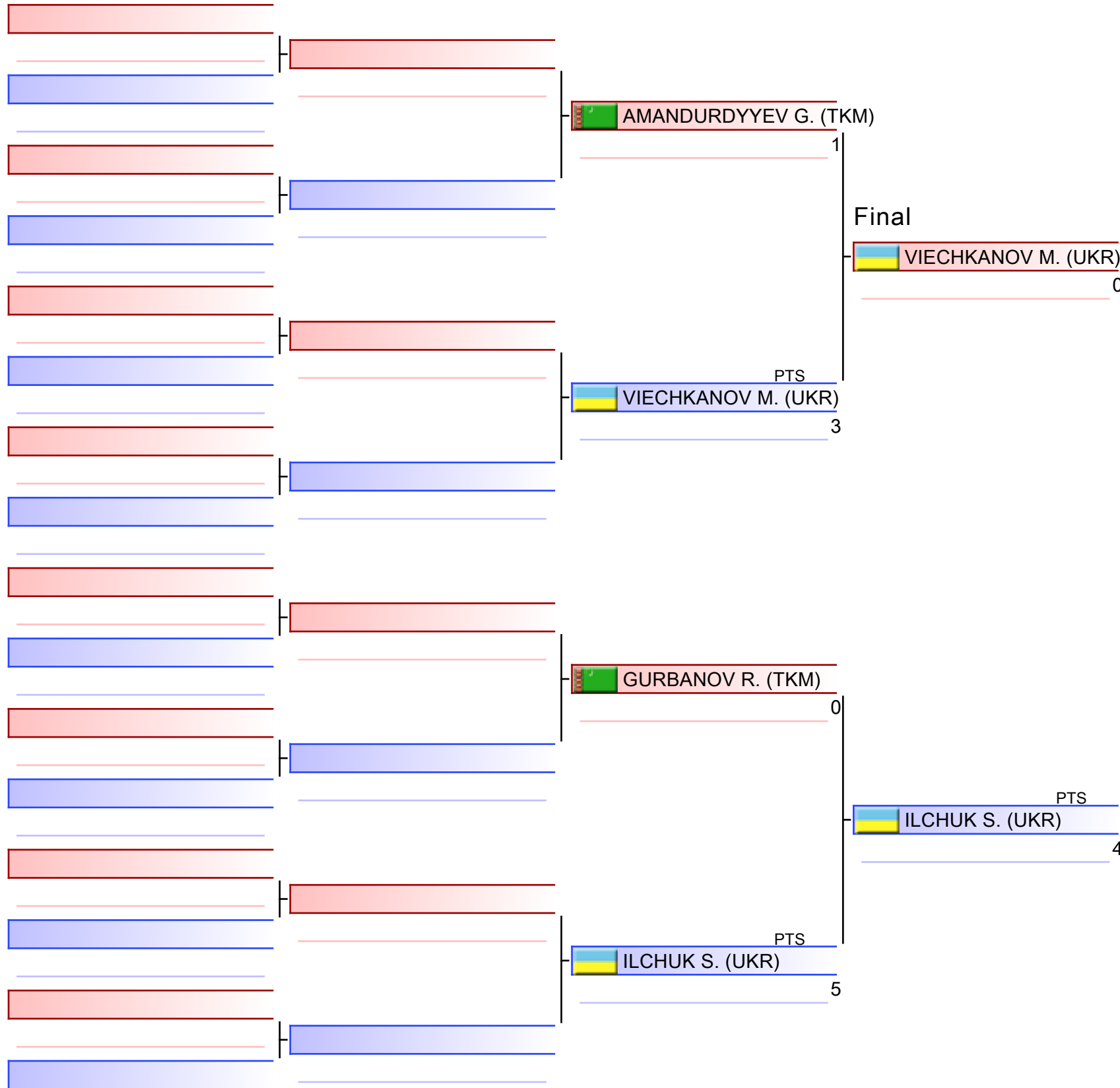

ILCHUK S. (UKR)

1. ILCHUK SAVELII (UKR)
2. VIECHKANOV MAKSYM (UKR)
3. GANBAROV VUSAL (AZE)
3. KOVAL DAVID (SVK)
5. GURBANOV REMEZAN (TKM)
5. AMANDURDYEV GURBANNAZAR (TKM)
7. ROLAND NATHAN (BEL)
7. CHAIBI SOUFIAN (ESP)

Cadet Kumite Male -52 kg

Karate1 Youth League - Venice 2024

2024-12-07

Tatami

1 15:20

Pool

1,2,3,4

(c)sportdata GmbH & Co KG 2000-2024 (2024-12-08 20:16) v 10.2.0 build 1 (2024-11-20 00:58 CET) License: SDIL TVG (expire 2025-01-26)

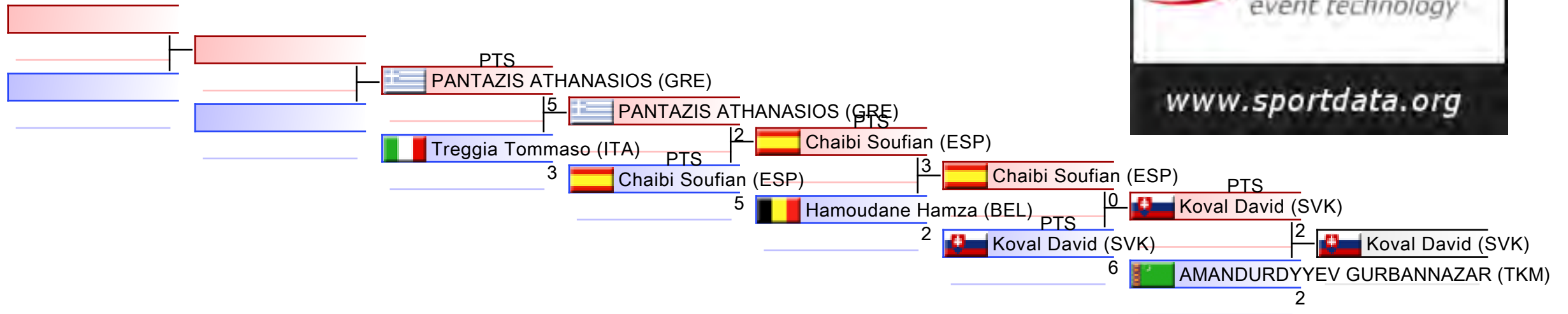

REPECHAGE: (1,2,3,4)

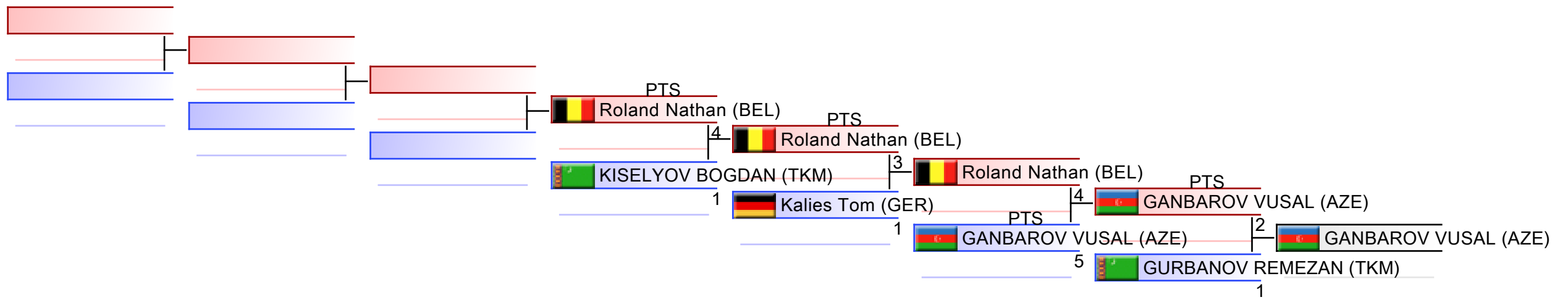



Karate1 Youth League - Venice 2024 - 2024-12-04



Official Results

Cadet Kumite Male -52 kg (Entries: 95 Nations: 32)			
1	ILCHUK SAVELII		UKR - UKRAINE
2	VIECHKANOV MAKSYM		UKR - UKRAINE
3	GANBAROV VUSAL		AZE - AZERBAIJAN
3	KOVAL DAVID		SVK - SLOVAKIA
5	GURBANOV REMEZAN		TKM - TURKMENISTAN
5	AMANDURDYEV GURBANNAZAR		TKM - TURKMENISTAN
7	ROLAND NATHAN		BEL - BELGIUM
7	CHAIBI SOUFIAN		ESP - SPAIN
9	KALIES TOM		GER - GERMANY
9	HAMOUDANE HAMZA		BEL - BELGIUM
11	KISELYOV BOGDAN		TKM - TURKMENISTAN
11	PANTAZIS ATHANASIOS		GRE - GREECE
13	TREGGIA TOMMASO		ITA - ITALY

CADET KUMITE MALE -57 KG



Karate1 Youth League - Venice 2024

ENTRIES BY WEIGHT CATEGORY



Cadet Kumite Male -57 kg

As of 8 DEC 2024

Country Code	ID	Gender	Name	Seeding
AZE	AZE03366	M	SAMADLI UGHUR	
BEL		M	QUARANTA Calogero	
BIH		M	Džafo Daris	
BIH		M	Lazic Lazar	
BIH		M	Simikic Dusan	
CRO		M	Ereš Karlo	
CRO		M	Janjić Franko	
CRO	CRO03456	M	KOMARAC FILIP	
CZE		M	Hampejs Adam	
CZE		M	Korch Václav	
CZE	CZE02492	M	SIMOTA DAVID	
CZE		M	Špánik Tobias	
CZE		M	Vrecion Tomislav	
ENG		M	Clarke - Foulds Riley	
ESP		M	QUESADA TORRES IVAN	
FRA	SD60798	M	Deberdt Mahé	
FRA		M	Doucare Axel	
FRA		M	Kandoussi Malek	
FRA		M	Le Guillou Benjamin	
FRA		M	PICARDAT Sylvain	
GEO	GEO002912	M	KOZIREVI TEVDORE	
GER	GER03356	M	Becker Finley	
GER	GER003977	M	HOERNER PAUL	
GER		M	Nahrman Mattis	
GER		M	Ruhmann Max	
GER		M	Swidersky Ben	
GER		M	Tschumarow André	
GRE	GRE02894	M	BITSORIS ANGELOS	
HKG	HKG02713	M	LAM TSZ PUI	
HUN		M	Bene Csaba	
HUN		M	Bilal David Musah	
HUN		M	Dávid Ákos Csiki	
HUN		M	Fejér Milán	
HUN		M	Gyurcsek Vince	
HUN		M	Horváth-Matheidesz Vilmos	
HUN		M	Losonci Lóránt Marcell	
HUN		M	Péter Csiki Csanád	
ITA		M	Apicella Carmine	
ITA		M	bamundo domenico	
ITA		M	Barone Salvatore	
ITA		M	BELLINZONA ROCCO	
ITA		M	Carrara Matteo	
ITA	ITA483229	M	CASTELLANO FEDERICO	
ITA		M	Crasti Alessandro	
ITA		M	Fidolini Tommaso	



Karate1 Youth League - Venice 2024

ENTRIES BY WEIGHT CATEGORY



Cadet Kumite Male -57 kg

As of 8 DEC 2024

Country Code	ID	Gender	Name	Seeding
ITA		M	GIORGINI ADAMO	
ITA		M	Giuliani Jacopo	
ITA		M	Luciani Manuel	
ITA		M	MARINI MATTEO	
ITA		M	Marino Emanuele	
ITA		M	MONICO LEONARDO	
ITA		M	Notturmo Jacopo	
ITA	ITA483232	M	PANARO ALESSANDRO	
ITA		M	PIAZZA FRANCESCO	
ITA		M	RABIEA RAIAN FARGHALI HOSSINI FARGHALI	
ITA		M	Segantini Andrea	
ITA		M	Simoni Emanuele	
JAM	JAM02216	M	EVANS RASANDRE VALENTINO	
KOS	KOS03012	M	POLLOMI ALMIR	
KOS	KOS003523	M	POLLOMI ILIR	
LAT		M	Varcabjuks Arsenijs	
LAT		M	Vietrins Maksims	
LAT		M	Zakmans Marks	
LAT		M	Zalevskis Vitalijs	
LUX	LUX02468	M	AGOSTINO ENZO	
LUX		M	Defense Dario	
MDA	MDA002537	M	FOCSA NICOLAI	
MDA	MDA002536	M	SOROCOLITA VASILII	
MDA	MDA02414	M	STOIANOV CHIRILL	
NED	SD60407	M	Lepez Devon	
NOR		M	Hansen Martin Walstad	
POL	POL3494	M	BISEWSKI JAROSLAW	
POR		M	Cardoso Manuel	
POR		M	Laranjeira Frederico	
POR	POR003307	M	PENA ANDRE	
ROU	ROU03588	M	BURNAZ DANIEL	
SCO		M	Cameron Bruce	
SCO		M	Guetarri Samir	
SLO	SLO02925	M	ERDELIC ZAN	
SRB		M	Krstin Filip	
SUI		M	Patricio--Clémont Johan	
SVK		M	Doncs Eugen	
SVK		M	Kotek Dominik	
SVK		M	Lehocky Adam	
SWE		M	Palm Arthur	
TKM	TKM02549	M	KAKALYYEV ALYMUHAMMET	
UKR		M	Fedorov Yevhenii	
UKR		M	Kucherenko Vasyl	
UKR		M	Makoviichuk Taras	
UKR		M	Manzhula Matvii	



Karate1 Youth League - Venice 2024
ENTRIES BY WEIGHT CATEGORY



Cadet Kumite Male -57 kg
As of 8 DEC 2024

Country Code	ID	Gender	Name	Seeding
UKR		M	MATVIEIEV KYRYL	
UKR		M	STRYZHEVSKYI DAVID	

Cadet Kumite Male -57 kg

Karate1 Youth League - Venice 2024, PALAZZO DEL TURISMO, Piazza Brescia 11, 30016 Lido di Jesolo VE, ITA

2024-12-07

Tatami
5 09:00

Pool
1/4

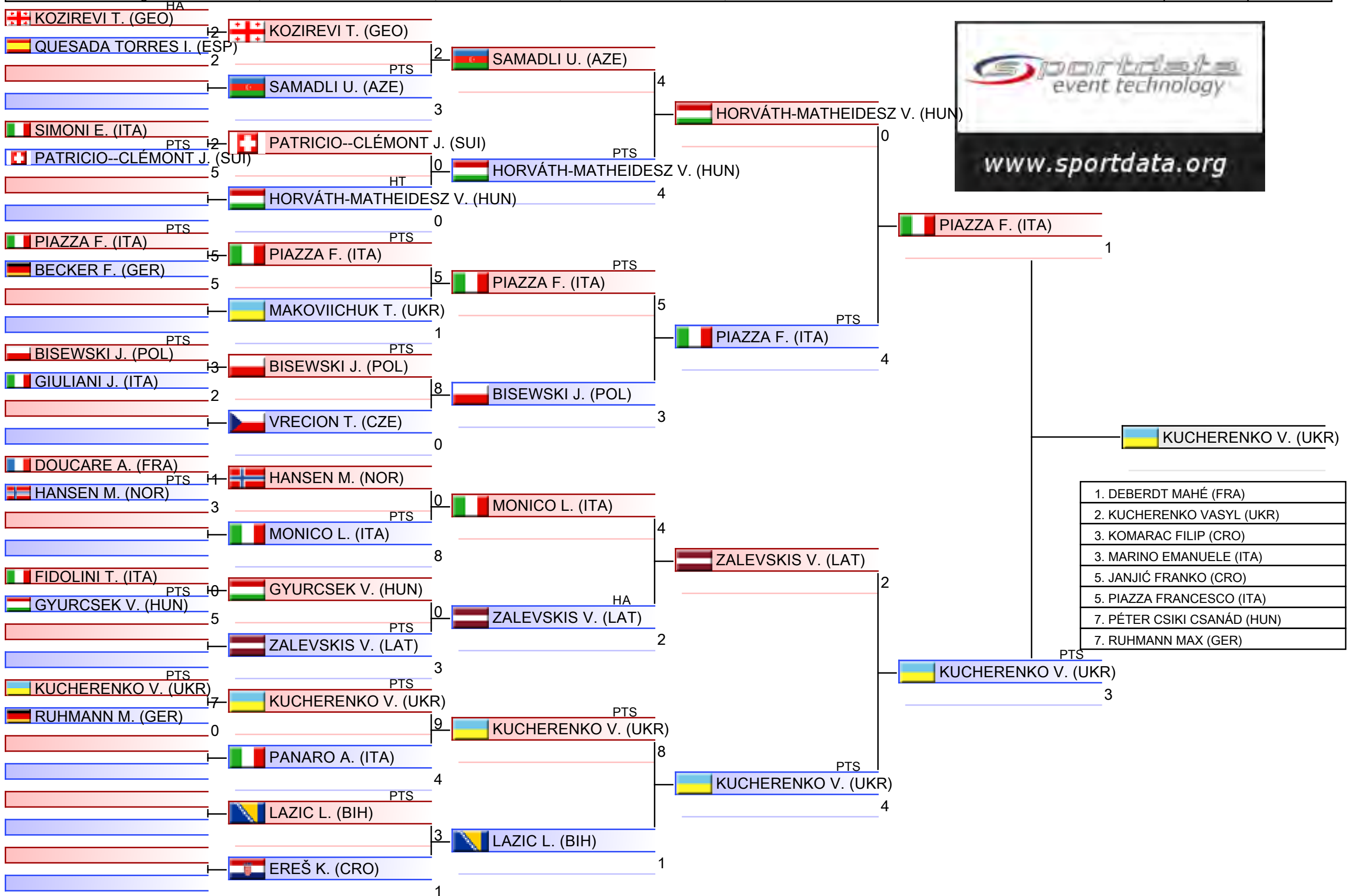

1. DEBERDT MAHÉ (FRA)
2. KUCHERENKO VASYL (UKR)
3. KOMARAC FILIP (CRO)
3. MARINO EMANUELE (ITA)
5. JANJIĆ FRANKO (CRO)
5. PIAZZA FRANCESCO (ITA)
7. PÉTER CSIKI CSANÁD (HUN)
7. RUHMANN MAX (GER)

Cadet Kumite Male -57 kg

Karate1 Youth League - Venice 2024, PALAZZO DEL TURISMO, Piazza Brescia 11, 30016 Lido di Jesolo VE, ITA

2024-12-07

Tatami
6 09:00

Pool
2/4

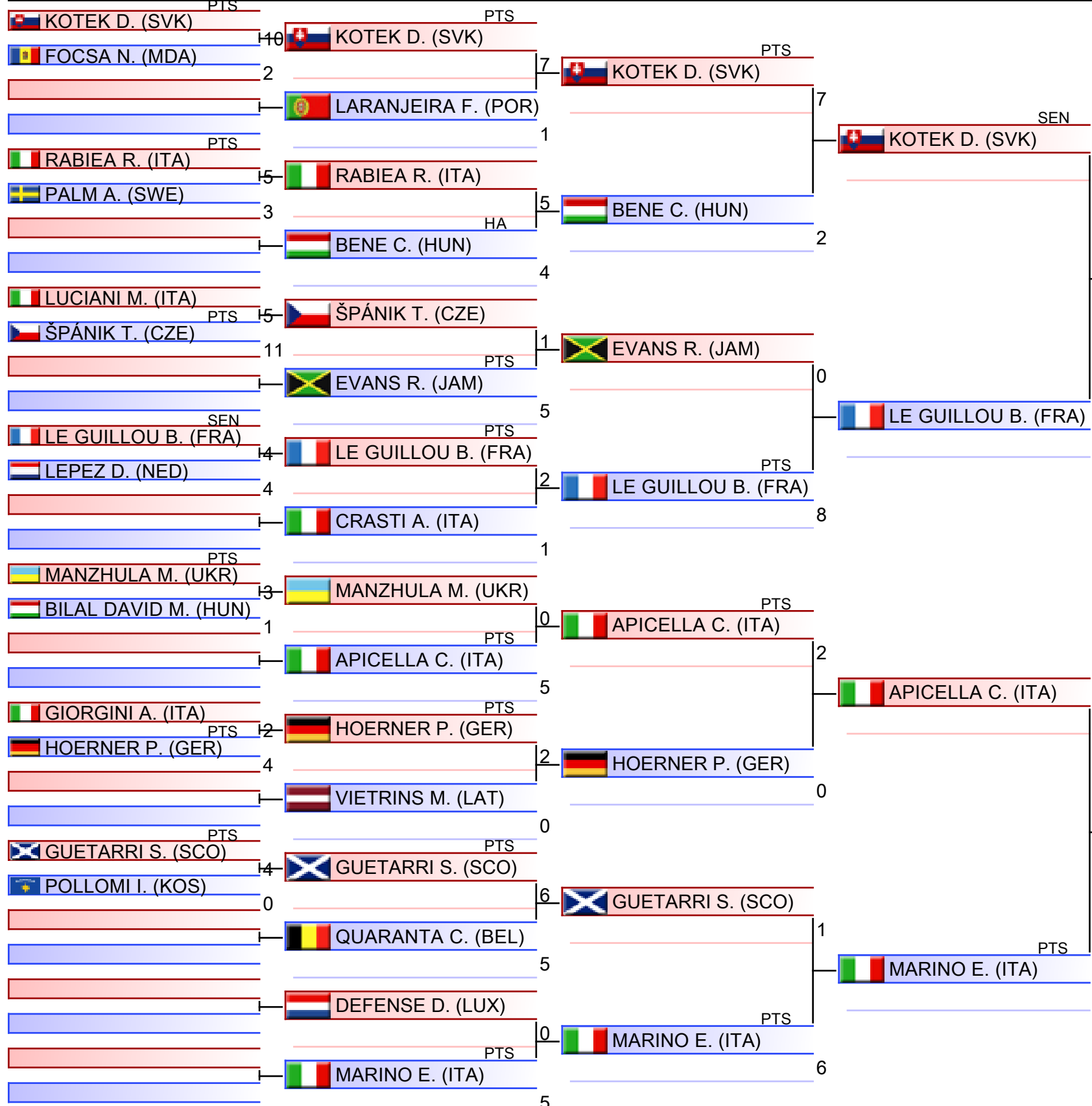

1. DEBERDT MAHÉ (FRA)
2. KUCHERENKO VASYL (UKR)
3. KOMARAC FILIP (CRO)
3. MARINO EMANUELE (ITA)
5. JANJIĆ FRANKO (CRO)
5. PIAZZA FRANCESCO (ITA)
7. PÉTER CSIKI CSANÁD (HUN)
7. RUHMANN MAX (GER)

Cadet Kumite Male -57 kg

Karate1 Youth League - Venice 2024, PALAZZO DEL TURISMO, Piazza Brescia 11, 30016 Lido di Jesolo VE, ITA

2024-12-07

Tatami
7 09:00

Pool
3/4

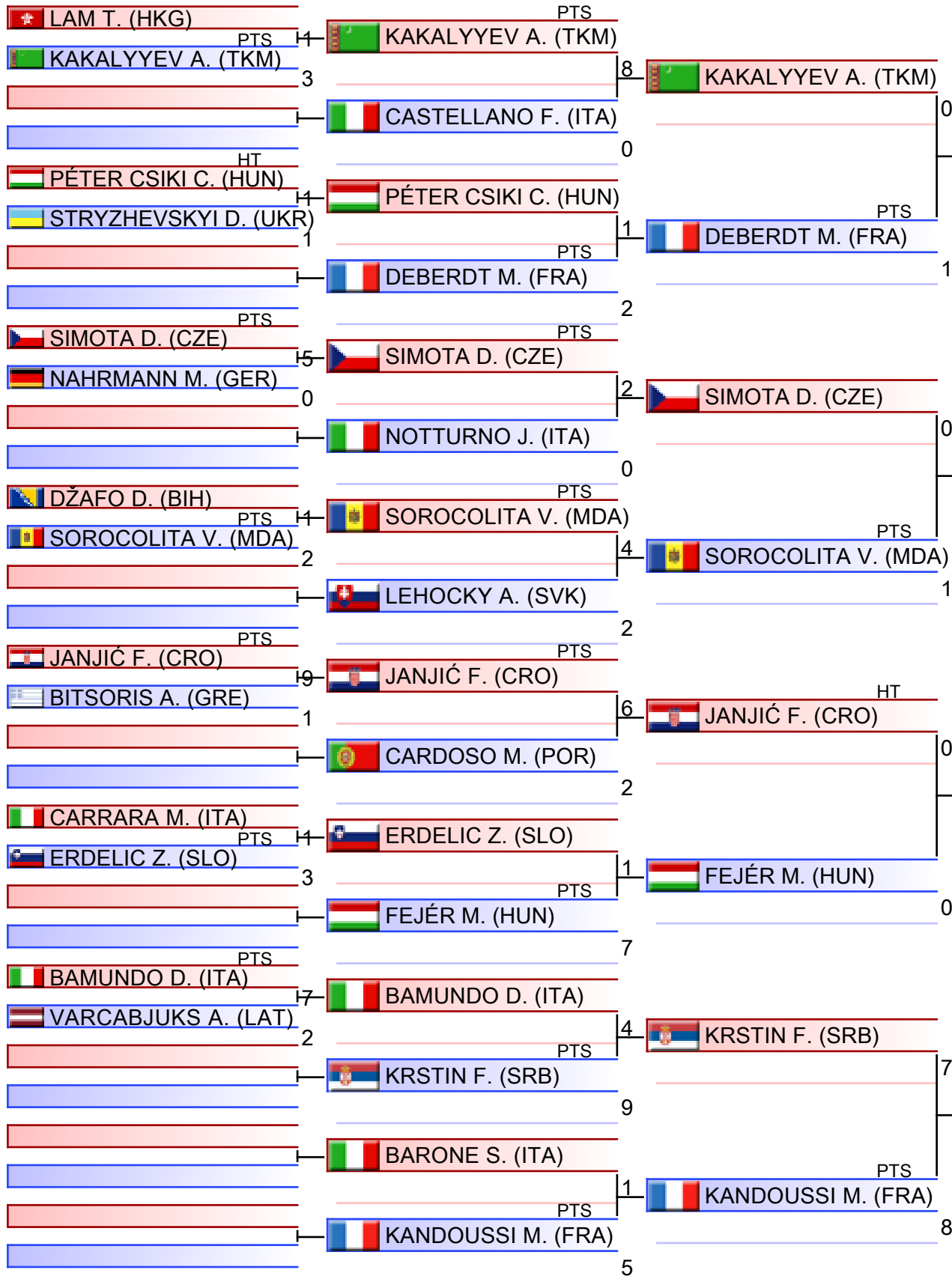

1. DEBERDT MAHÉ (FRA)
2. KUCHERENKO VASYL (UKR)
3. KOMARAC FILIP (CRO)
3. MARINO EMANUELE (ITA)
5. JANJIĆ FRANKO (CRO)
5. PIAZZA FRANCESCO (ITA)
7. PÉTER CSIKI CSANÁD (HUN)
7. RUHMANN MAX (GER)

Cadet Kumite Male -57 kg

Karate1 Youth League - Venice 2024, PALAZZO DEL TURISMO, Piazza Brescia 11, 30016 Lido di Jesolo VE, ITA

2024-12-07

Tatami
8 09:00

Pool
4/4

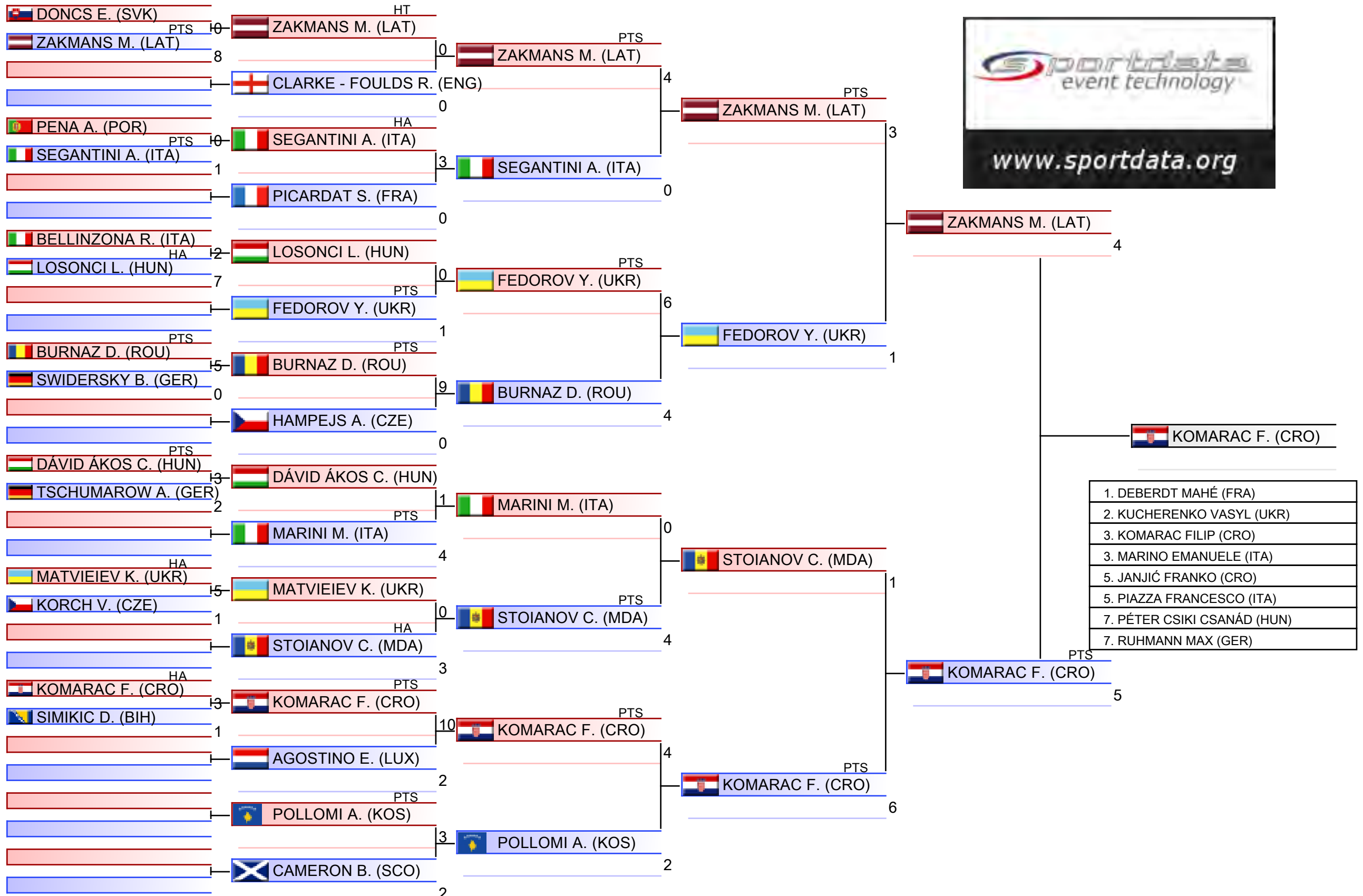

1. DEBERDT MAHÉ (FRA)
2. KUCHERENKO VASYL (UKR)
3. KOMARAC FILIP (CRO)
3. MARINO EMANUELE (ITA)
5. JANJIĆ FRANKO (CRO)
5. PIAZZA FRANCESCO (ITA)
7. PÉTER CSIKI CSANÁD (HUN)
7. RUHMANN MAX (GER)

Pool winner-Cadet Kumite Male -57 kg

Karate1 Youth League - Venice 2024, PALAZZO DEL TURISMO, Piazza Brescia 11, 30016 Lido di Jesolo VE, ITA

2024-12-07

Tatami

5 11:00

Pool

1/1

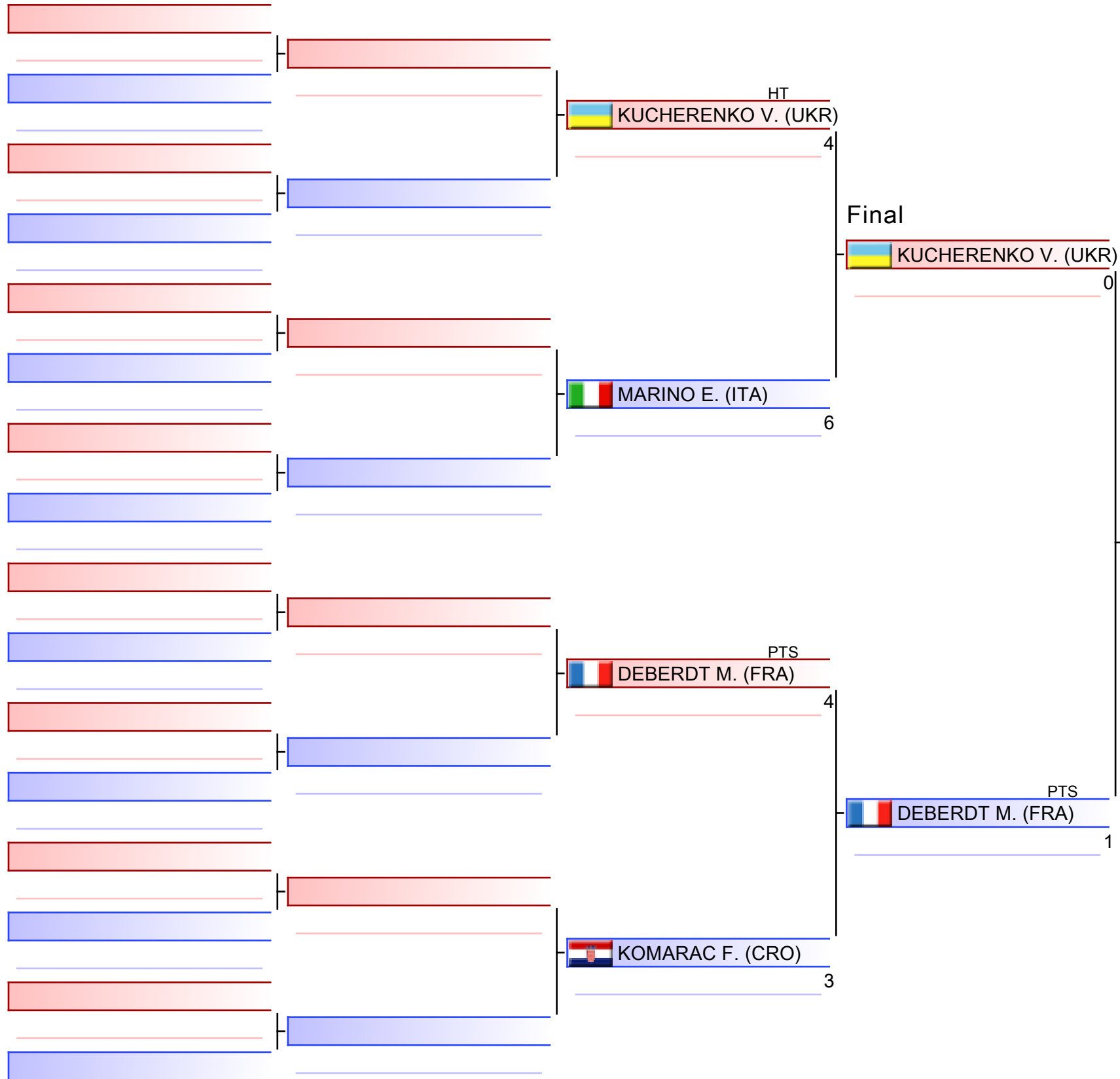

1. DEBERDT MAHÉ (FRA)
2. KUCHERENKO VASYL (UKR)
3. KOMARAC FILIP (CRO)
3. MARINO EMANUELE (ITA)
5. JANJIĆ FRANKO (CRO)
5. PIAZZA FRANCESCO (ITA)
7. PÉTER CSIKI CSANÁD (HUN)
7. RUHMANN MAX (GER)

Cadet Kumite Male -57 kg

Karate1 Youth League - Venice 2024

2024-12-07

Tatami

2 15:15

Pool

4,1,2,3

(c)sportdata GmbH & Co KG 2000-2024 (2024-12-08 20:16) v 10.2.0 build 1 (2024-11-20 00:58 CET) License: SDIL TVG (expire 2025-01-26)

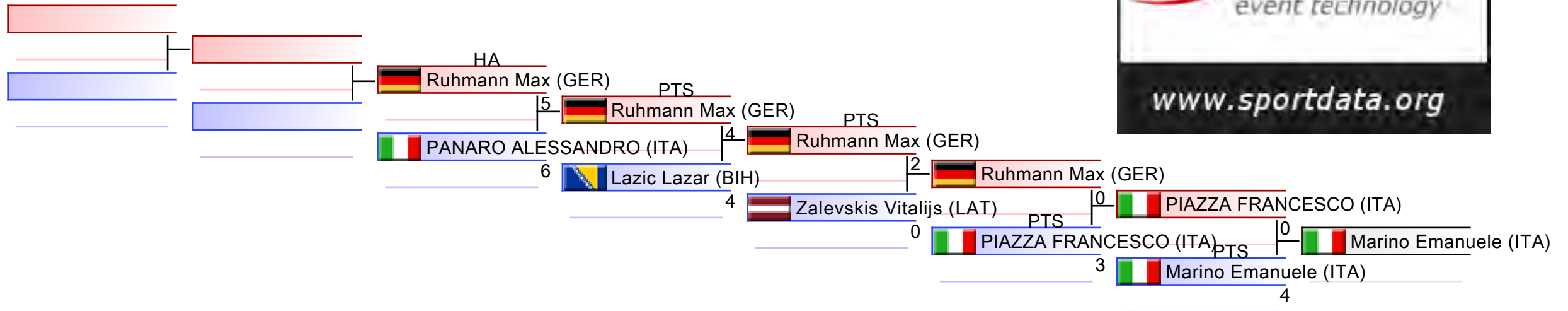

REPECHAGE: (4,1,2,3)

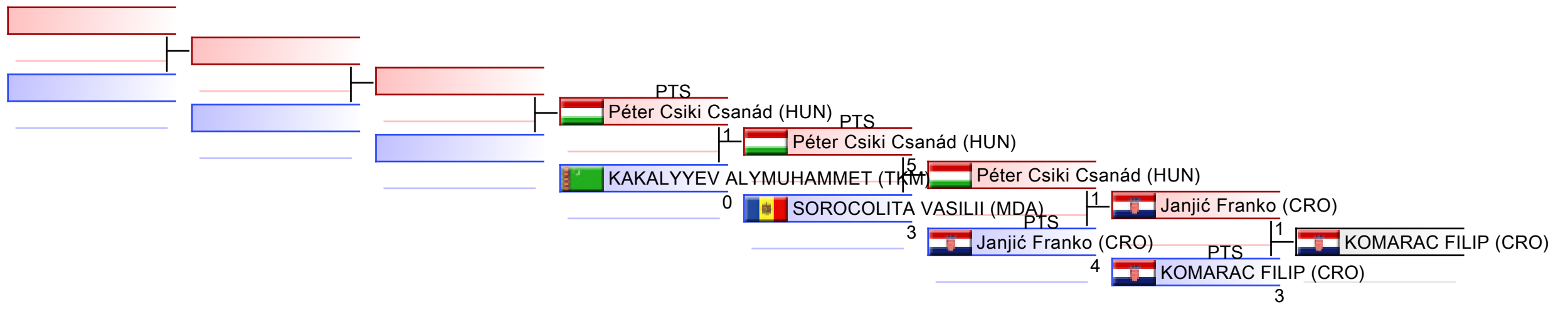



Karate1 Youth League - Venice 2024 - 2024-12-04



Official Results

Cadet Kumite Male -57 kg (Entries: 92 Nations: 32)			
1	DEBERDT MAHÉ		FRA - FRANCE
2	KUCHERENKO VASYL		UKR - UKRAINE
3	KOMARAC FILIP		CRO - CROATIA
3	MARINO EMANUELE		ITA - ITALY
5	JANJIĆ FRANKO		CRO - CROATIA
5	PIAZZA FRANCESCO		ITA - ITALY
7	PÉTER CSIKI CSANÁD		HUN - HUNGARY
7	RUHMANN MAX		GER - GERMANY
9	SOROCOLITA VASILII		MDA - MOLDOVA, REPUBLIC OF
9	ZALEVSKIS VITALIJS		LAT - LATVIA
11	KAKALYYEV ALYMUHAMMET		TKM - TURKMENISTAN
11	LAZIC LAZAR		BIH - BOSNIA AND HERZEGOVINA
13	PANARO ALESSANDRO		ITA - ITALY

CADET KUMITE MALE -63 KG



Karate1 Youth League - Venice 2024

ENTRIES BY WEIGHT CATEGORY



Cadet Kumite Male -63 kg

As of 8 DEC 2024

Country Code	ID	Gender	Name	Seeding
AZE	AZE003403	M	JAFARLI MAHYADDIN	
BEL		M	Jaber-raïs Ismael	
BEL		M	Mrhani Mehdi	
BIH		M	Busnov Ahmed	
BIH		M	Hamzić Hamza	
BIH		M	Rahmanović Imran	
CAN	CAN003936	M	MONGRAIN THEO	
CRO		M	Babic Borna	
CRO	CRO03718	M	BIRAC NIKOLA	
CRO		M	Hulina Vito	
CRO		M	Manestar Petar	
CRO	CRO03084	M	Zeljko Ivan	
CZE	CZE02491	M	ENEV MARTIN	
CZE		M	Falion Maxim	
CZE		M	Šupka Tobiáš	
ENG		M	Darnell Alex	
ENG		M	Evans Will	
ENG		M	Wells Daniel	
ESP		M	ALCALA JIMENEZ ALBERTO	
ESP		M	mateo antunez cesar	
ESP		M	Morillo Lozano Israel	
ESP	SD51060	M	PETAGNA PAOLO	
FRA		M	Alves Nathan	
FRA		M	Cissokho Youssouf	
FRA		M	DELAUNAY Damien	
FRA		M	Jambart Maxence	
GER		M	Drehmann Till	
GER		M	Kuchel Lennox	
GER	GER03306	M	Niederelz Tim	
GER		M	Pagin Lukasz	
HUN		M	Fekete Márton Rudolf	
HUN		M	Nagy Ákos Botond	
HUN		M	Péter Márton	
HUN		M	Peter Balint Illes	
ITA		M	BALDASSARRE RAFFAELE	
ITA		M	Basso Marco	
ITA		M	Bersanetti Andrea	
ITA		M	Boraso Tancredi	
ITA		M	CAMEROTA ISAAC MATTIA	
ITA		M	CHIESA BRIAN	
ITA		M	Di Fonte Nicolas	
ITA		M	GIORGINI ALESSANDRO	
ITA		M	Licciardi Simone	
ITA		M	Marinelli Rocco	
ITA		M	mazzotta edoardo	



Karate1 Youth League - Venice 2024

ENTRIES BY WEIGHT CATEGORY



Cadet Kumite Male -63 kg
As of 8 DEC 2024

Country Code	ID	Gender	Name	Seeding
ITA		M	PALOMBARO FRANCESCO	
ITA		M	Polistena Andrea	
ITA		M	pontassuglia francesco	
ITA		M	rodà nicolas	
ITA		M	Rorato Tommaso	
ITA		M	RUOCCO ARMANDO	
ITA		M	solomon gleb	
ITA		M	SPINESI LEONARDO	
ITA		M	VIPERA LORENZO	
ITA		M	Zinno Alessandro	
KOS	KOS03441	M	CURRI AID	
LAT		M	Sorohovs Kirills	
LUX		M	Todorovic Filip	
MDA	MDA02232	M	DOBROVOLSCHI DENIS	
MDA	MDA002531	M	STRATAN MATVEI	
MDA	MDA002535	M	TERZI DEN	
MDA	MDA002530	M	VASILIEV ILIA	
NOR	NOR02719	M	Fagerli Demian	
POL	POL3495	M	BISEWSKI BARTOSZ	
POL	POL3562	M	CICHECKI IGOR	
POL	POL2542	M	Grzybek Hubert	
POL	POL2909	M	KASPRZAK PASCAL	
POL	POL09390	M	SEWASTIANOWICZ JULIAN	
POR		M	Aguiar Gustavo	
POR		M	Bernardes Duarte	
POR		M	Oliveira Tomás	
ROU	ROU003966	M	CRISTIAN IONESCU	
ROU	ROU02704	M	DUMITRU ROBERT	
SCO		M	Estrada Tomas	
SLO	SLO003053	M	SEDONJA MATIJA	
SUI		M	Lüthi Moritz	
SVK		M	Chrenko Samuel	
SVK		M	Dado Alex	
SVK	SD77100	M	Géci Boris	
SVK	SD77113	M	Kysucký Lukáš	
SVK		M	Pasnišin Maroš	
TKM	TKM02654	M	JUMANOV SERDAR	
TUR		M	Aslantaş Deniz	
UKR		M	Ilnytskyi Illia	
UKR		M	Kanivets Vladyslav	
UKR		M	Kozachenko Maksym	
USA	USA02988	M	Farris Logan	
VEN		M	GASCON GUTIERREZ AARON MOISES	
VEN	VEN003082	M	IGNACIO RIOS	
VEN		M	LUCAS MUJICA TOMAS	



Karate1 Youth League - Venice 2024

ENTRIES BY WEIGHT CATEGORY



Cadet Kumite Male -63 kg

Karate1 Youth League - Venice 2024, PALAZZO DEL TURISMO, Piazza Brescia 11, 30016 Lido di Jesolo VE, ITA

2024-12-07

Tatami
1 11:15

Pool
1/4

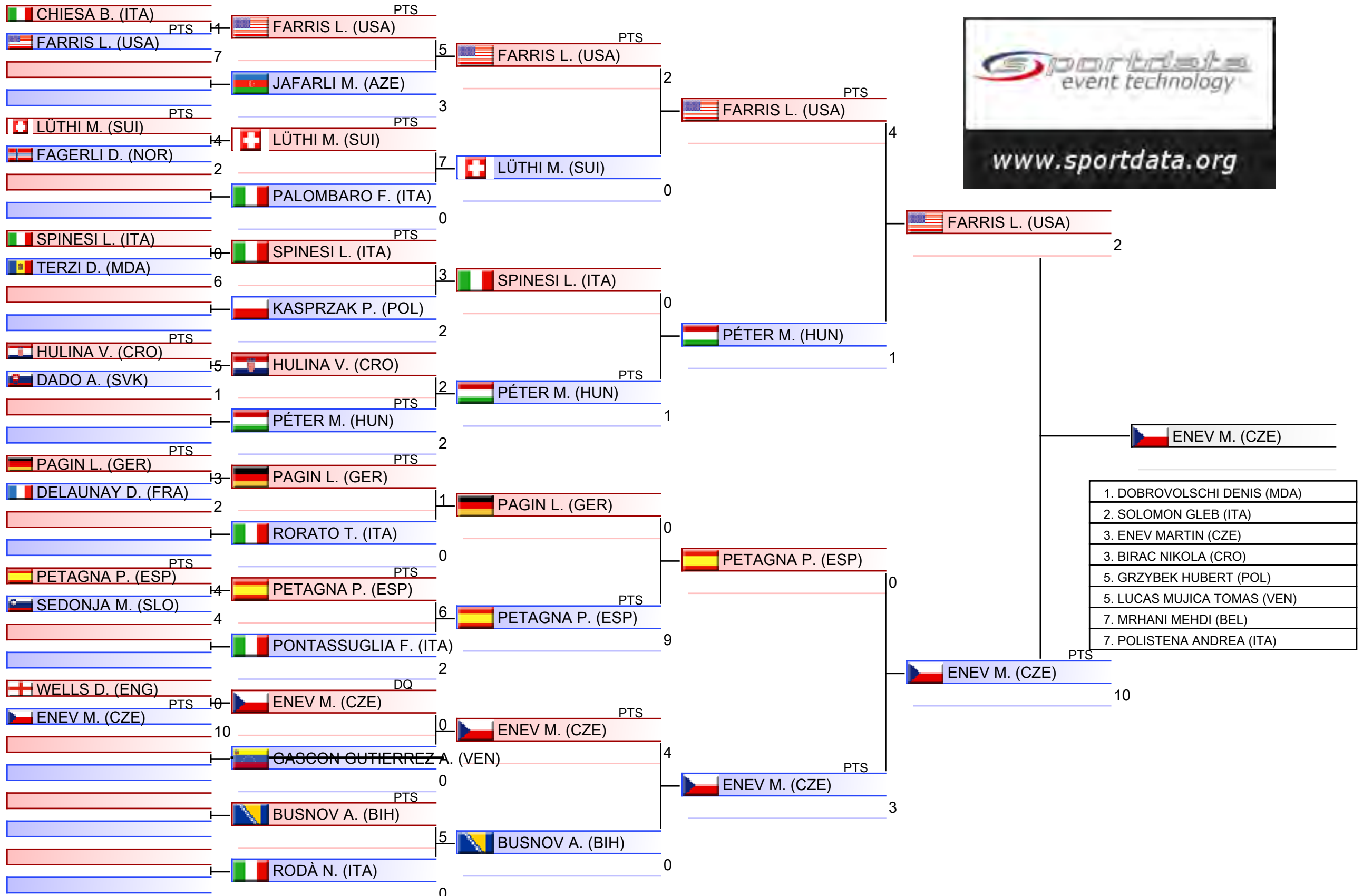

Cadet Kumite Male -63 kg

Karate1 Youth League - Venice 2024, PALAZZO DEL TURISMO, Piazza Brescia 11, 30016 Lido di Jesolo VE, ITA

2024-12-07

Tatami
2 11:15

Pool
2/4

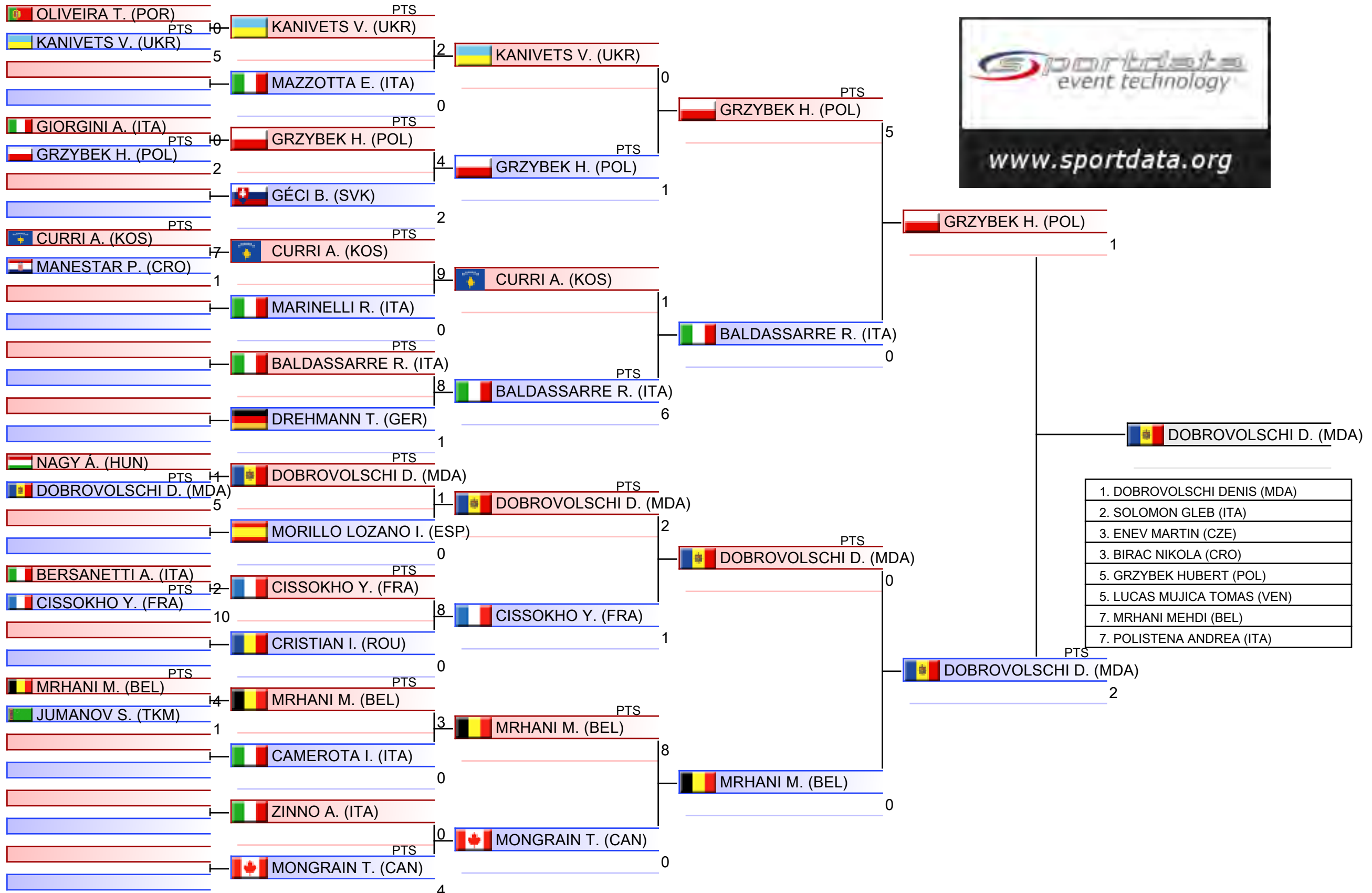

1. DOBROVOLSCHI DENIS (MDA)
2. SOLOMON GLEB (ITA)
3. ENEV MARTIN (CZE)
3. BIRAC NIKOLA (CRO)
5. GRZYBEK HUBERT (POL)
5. LUCAS MUJICA TOMAS (VEN)
7. MRHANI MEHDI (BEL)
7. POLISTENA ANDREA (ITA)

Cadet Kumite Male -63 kg

Karate1 Youth League - Venice 2024, PALAZZO DEL TURISMO, Piazza Brescia 11, 30016 Lido di Jesolo VE, ITA

2024-12-07

Tatami
3 11:15

Pool
3/4

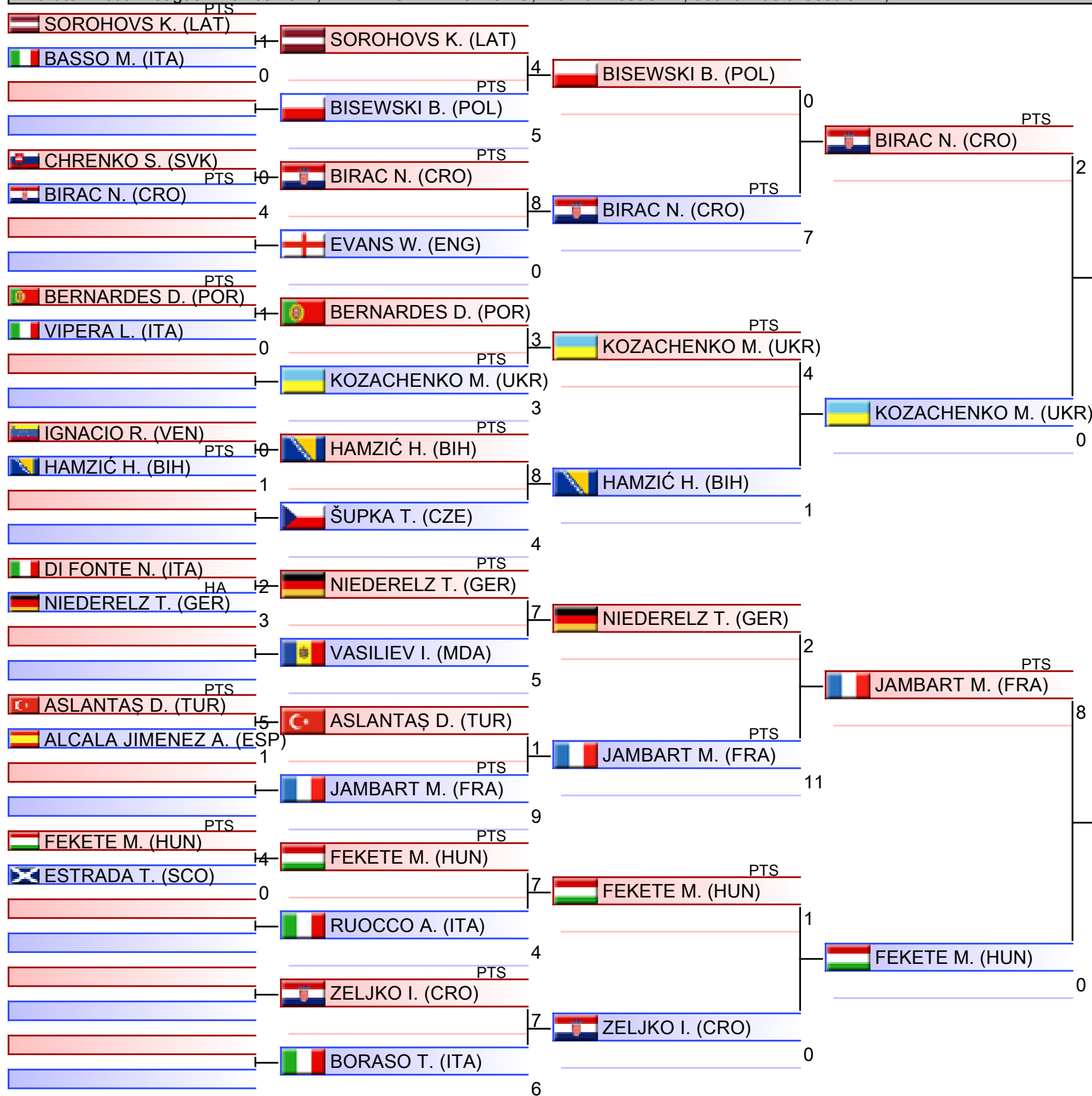

1. DOBROVOLSCHI DENIS (MDA)
2. SOLOMON GLEB (ITA)
3. ENEV MARTIN (CZE)
3. BIRAC NIKOLA (CRO)
5. GRZYBEK HUBERT (POL)
5. LUCAS MUJICA TOMAS (VEN)
7. MRHANI MEHDI (BEL)
7. POLISTENA ANDREA (ITA)

Cadet Kumite Male -63 kg

Karate1 Youth League - Venice 2024, PALAZZO DEL TURISMO, Piazza Brescia 11, 30016 Lido di Jesolo VE, ITA

2024-12-07

Tatami
4 11:15

Pool
4/4

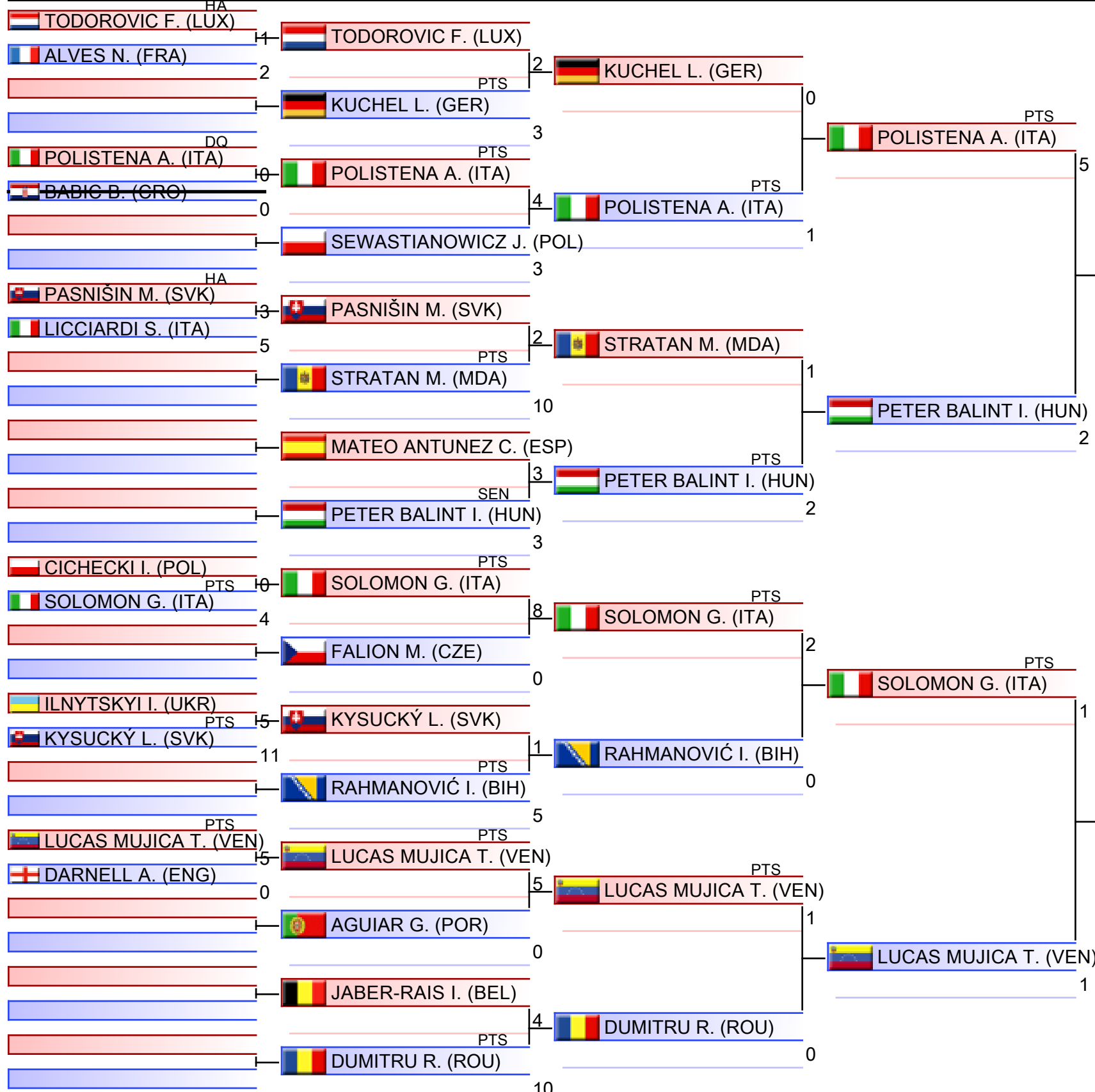

1. DOBROVOLSCHI DENIS (MDA)
2. SOLOMON GLEB (ITA)
3. ENEV MARTIN (CZE)
3. BIRAC NIKOLA (CRO)
5. GRZYBEK HUBERT (POL)
5. LUCAS MUJICA TOMAS (VEN)
7. MRHANI MEHDI (BEL)
7. POLISTENA ANDREA (ITA)

Pool winner-Cadet Kumite Male -63 kg

Karate1 Youth League - Venice 2024, PALAZZO DEL TURISMO, Piazza Brescia 11, 30016 Lido di Jesolo VE, ITA

2024-12-07

Tatami
1 13:15

Pool
1/1

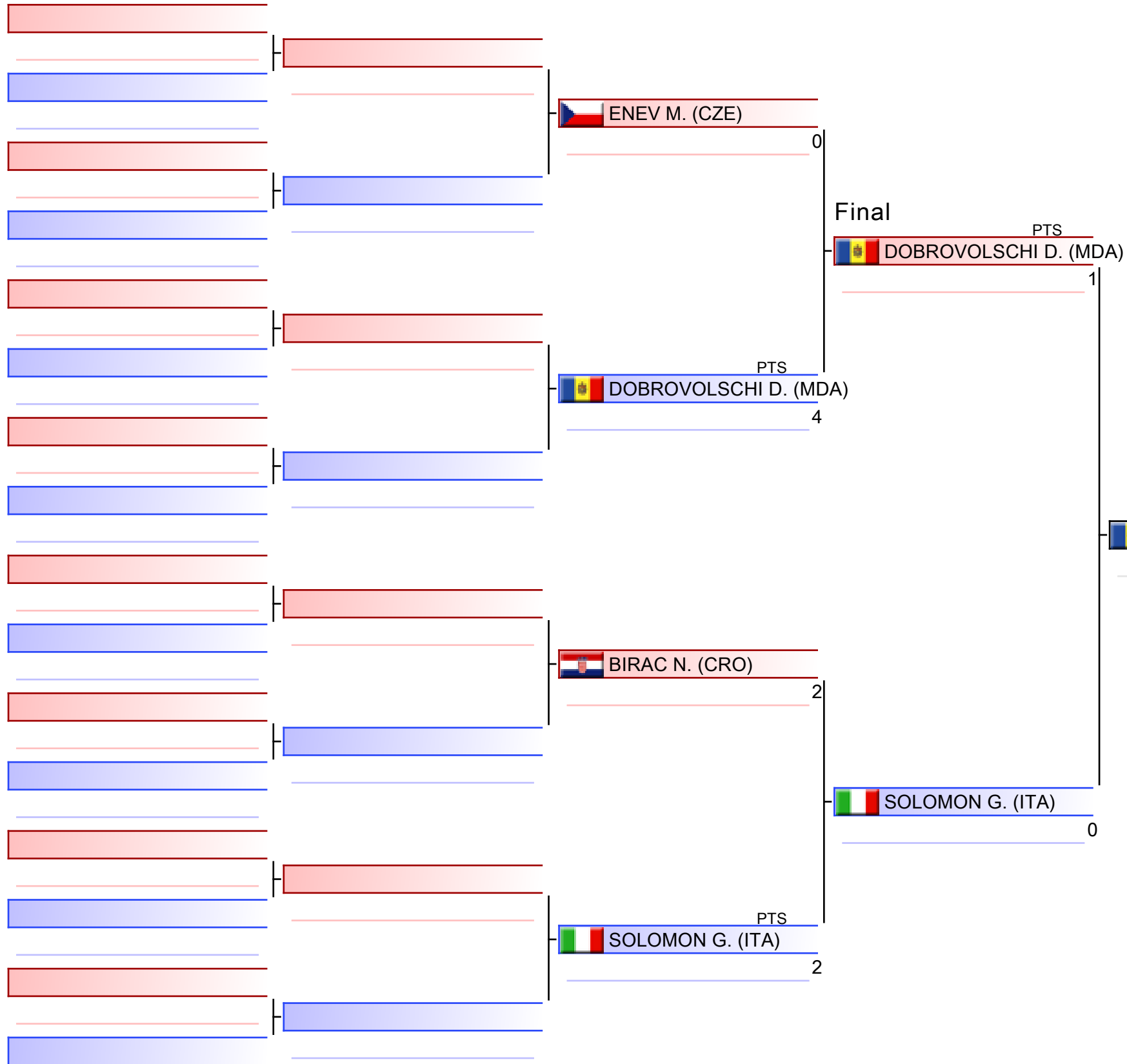

DOBROVOLSCHI D. (MDA)

1. DOBROVOLSCHI DENIS (MDA)
2. SOLOMON GLEB (ITA)
3. ENEV MARTIN (CZE)
3. BIRAC NIKOLA (CRO)
5. GRZYBEK HUBERT (POL)
5. LUCAS MUJICA TOMAS (VEN)
7. MRHANI MEHDI (BEL)
7. POLISTENA ANDREA (ITA)

Cadet Kumite Male -63 kg

Karate1 Youth League - Venice 2024

2024-12-07

Tatami

3 15:20

Pool

1,2,3,4

(c)sportdata GmbH & Co KG 2000-2024 (2024-12-08 20:16) v 10.2.0 build 1 (2024-11-20 00:58 CET) License: SDIL TVG (expire 2025-01-26)

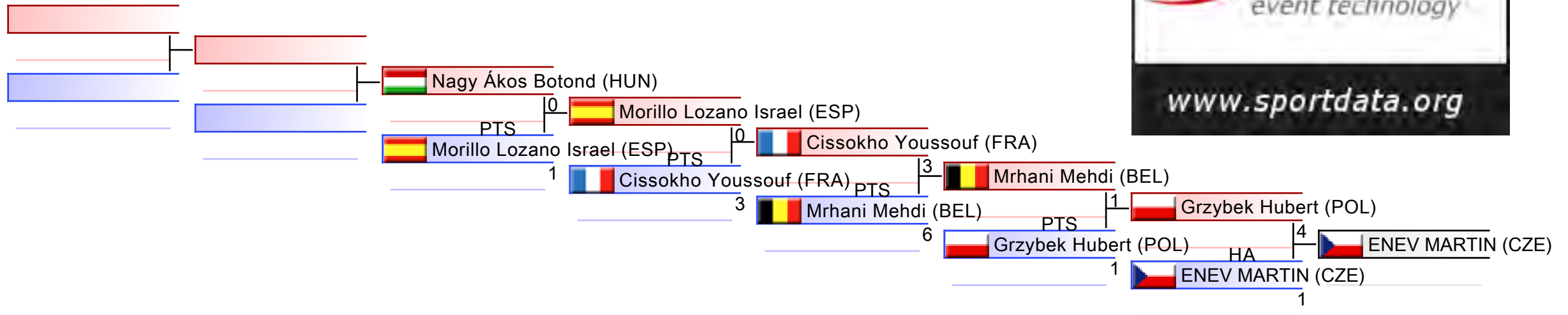

REPECHAGE: (1,2,3,4)

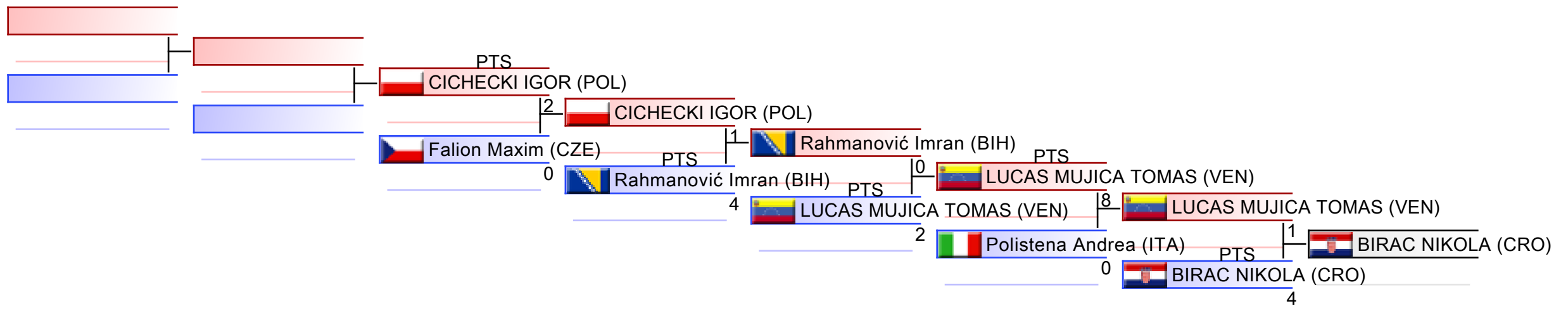



Karate1 Youth League - Venice 2024 - 2024-12-04



Official Results

Cadet Kumite Male -63 kg (Entries: 90 Nations: 29)			
1	DOBROVOLSCHI DENIS		MDA - MOLDOVA, REPUBLIC OF
2	SOLOMON GLEB		ITA - ITALY
3	ENEV MARTIN		CZE - CZECH REPUBLIC
3	BIRAC NIKOLA		CRO - CROATIA
5	GRZYBEK HUBERT		POL - POLAND
5	LUCAS MUJICA TOMAS		VEN - VENEZUELA
7	MRHANI MEHDI		BEL - BELGIUM
7	POLISTENA ANDREA		ITA - ITALY
9	CISSOKHO YOUSOUF		FRA - FRANCE
9	RAHMANOVIĆ IMRAN		BIH - BOSNIA AND HERZEGOVINA
11	MORILLO LOZANO ISRAEL		ESP - SPAIN
11	CICHECKI IGOR		POL - POLAND
13	NAGY ÁKOS BOTOND		HUN - HUNGARY
13	FALION MAXIM		CZE - CZECH REPUBLIC

CADET KUMITE MALE -70 KG



Karate1 Youth League - Venice 2024

ENTRIES BY WEIGHT CATEGORY



Cadet Kumite Male -70 kg
As of 8 DEC 2024

Country Code	ID	Gender	Name	Seeding
ARM		M	MAKYAN DANIEL	
BEL		M	Bourlard Lenny	
BIH		M	Gadžo Adis	
BIH		M	Karaga Rijad	
BIH		M	Karaga Zijad	
BUL		M	Mihov Martin	
CRO	CRO03454	M	Bermanec David	
CRO		M	Filipovic David	
CRO	CRO03047	M	MATIJEVIC ANTE	
CRO		M	Piškur Jakov	
CRO	CRO03364	M	SLUKIC PETAR	
CYP		M	ANASTASIADIS AGGELOS	
CYP		M	DEMETRIOU ELEFThERIOS	
CYP		M	TINOS ALEXANDROS	
CZE	CZE003003	M	FAJT JAKUB	
CZE		M	Matoušek Libor	
CZE		M	Šourek Jan	
CZE	SD54269	M	Štáhlavský David	
ENG		M	Gill Antonio	
ENG		M	Ousey Joe	
ESP	ESP003957	M	Benito Medina Raul	
ESP		M	LACUEVA MARTINEZ GENIS	
ESP		M	ROMAN MARTIN DAVID	
FRA		M	diallo oumar alpha	
FRA		M	MECHAI Haceyne	
GER		M	Kurz Phil	
GER		M	Liubimov Dmytro	
GER	GER003924	M	MUELLER MARIUS	
GER	GER004013	M	RAAZ JULIAN	
GRE		M	PAPAGRIGORIOU KOSMAS	
HUN		M	Kovács Konrád	
HUN		M	Ruzsinszki Balázs	
ITA		M	ARMANO GIANFRANCO	
ITA		M	bellillo Nicolò	
ITA		M	BENOTTO ALESSIO	
ITA		M	Bianco Alessandro	
ITA		M	Cialente Federico	
ITA		M	FANTINI FRANCESCO	
ITA		M	GIULIANO SIMONE	
ITA		M	LORENZO DONOFRIO	
ITA		M	NASSO ANDREA	
ITA		M	Russo Antonio	
ITA		M	Sini Edoardo	
KOS	KOS02551	M	HAMITI ENKEL	
LAT		M	Azans Maksims	



Karate1 Youth League - Venice 2024

ENTRIES BY WEIGHT CATEGORY



Cadet Kumite Male -70 kg

As of 8 DEC 2024

Country Code	ID	Gender	Name	Seeding
LAT		M	Kalinovs Aleksandrs	
LAT		M	Sevcovs Artjoms	
LUX	LUX02423	M	FECCHI MATTEO	
LUX		M	Pierantoni Matteo	
MKD		M	Elmazi Isa	
MNE		M	Kosović Andrija	
PER		M	Sánchez Injante Walter Jesús	
POL	POL3246	M	GAJDUS WOJCIECH	
POL	POL06329	M	MICKIEWICZ ANTONI	
POR		M	Borges Troy	
POR		M	Costa Pedro	
POR	POR03188	M	Moreira Jerónimo Valentim Pedro	
POR		M	Rodrigues Rafael	
ROU	ROU03715	M	DOLOMAN MIHAI CRISTIAN	
ROU	ROU003967	M	GABRIEL BOTEA	
ROU	ROU03586	M	LUTA ANDREI	
ROU	ROU003972	M	MIHAI DRAGOS SARU	
ROU	ROU003960	M	RAIS CONSTANTIN	
SLO	SLO03040	M	KELEMAN VUK	
SLO	SLO003075	M	VATOVEC ERNEST	
SRB		M	Toković Mihailo	
SUI		M	Soliaryk Platon	
SVK		M	Foltin Milan	
SVK		M	Kvasnica Martin	
SVK		M	Pšenák Matúš	
SYR		M	Kashash Thaer	
TKM	TKM02655	M	JEYHUNOV MYRAT	
TUR		M	Altın Muhammet Emir	
TUR		M	KUTUK UTKU TAHA	
UKR		M	Kozak Kostiantyn	
UKR		M	Piekhtieriev Mykhailo	
UKR		M	Shakhov Mykola	
UKR		M	Talama Artur	
UKR		M	Urumian Yurii	
UKR		M	VOITSIKHOVSKYU MYKOLA	
UKR		M	Zhyliuk Yehor	
USA		M	Davila Martin	
VEN	VEN003130	M	Ruz Luis	

Cadet Kumite Male -70 kg

Karate1 Youth League - Venice 2024, PALAZZO DEL TURISMO, Piazza Brescia 11, 30016 Lido di Jesolo VE, ITA

2024-12-07

Tatami
5 11:10

Pool
1/4

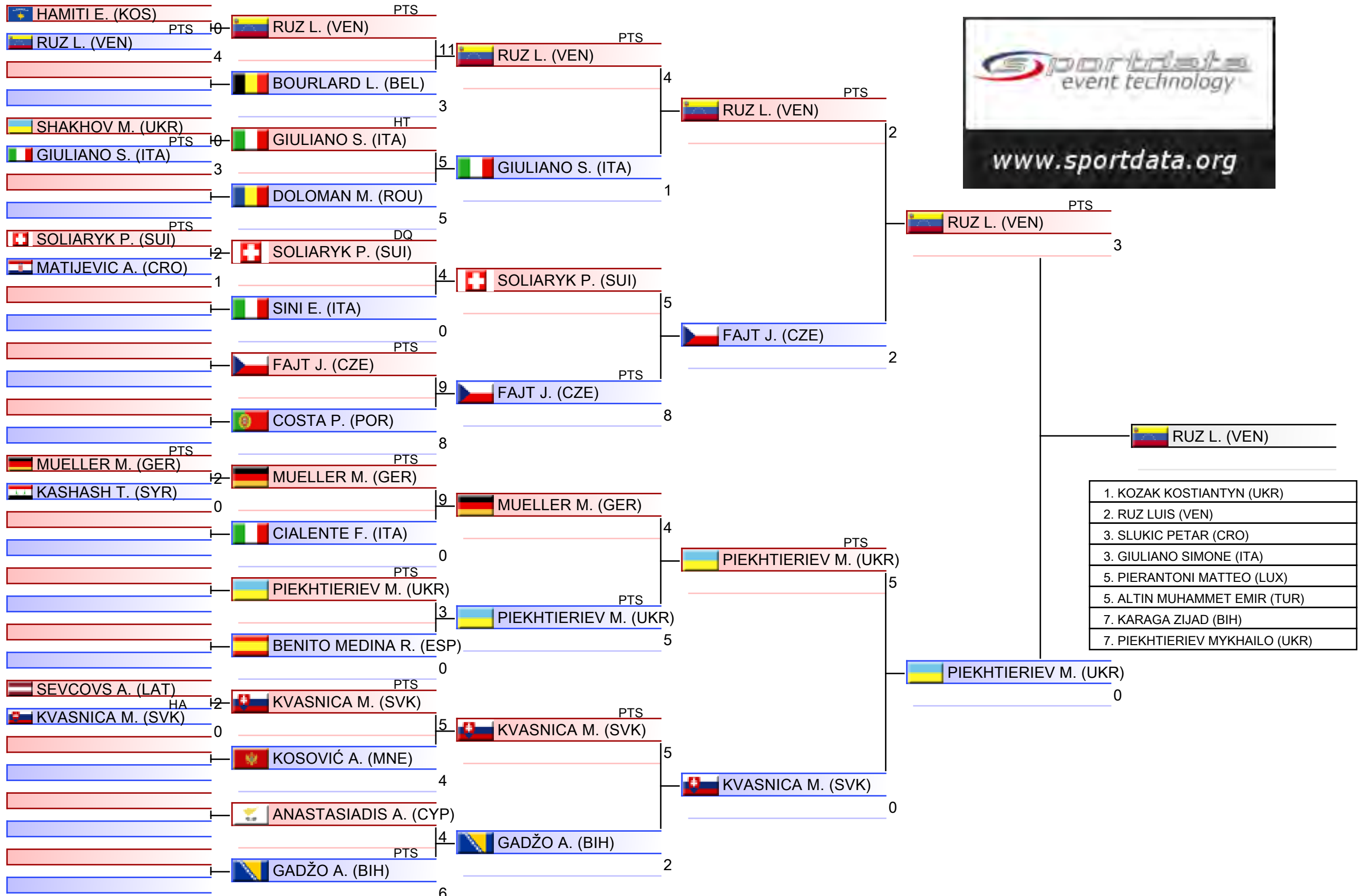

- | |
|--------------------------------|
| 1. KOZAK KOSTIANTYN (UKR) |
| 2. RUZ LUIS (VEN) |
| 3. SLUKIC PETAR (CRO) |
| 3. GIULIANO SIMONE (ITA) |
| 5. PIERANTONI MATTEO (LUX) |
| 5. ALTIN MUHAMMET EMIR (TUR) |
| 7. KARAGA ZIJAD (BIH) |
| 7. PIEKHTIERIEV MYKHAILO (UKR) |

Cadet Kumite Male -70 kg

Karate1 Youth League - Venice 2024, PALAZZO DEL TURISMO, Piazza Brescia 11, 30016 Lido di Jesolo VE, ITA

2024-12-07

Tatami
6 11:10

Pool
2/4

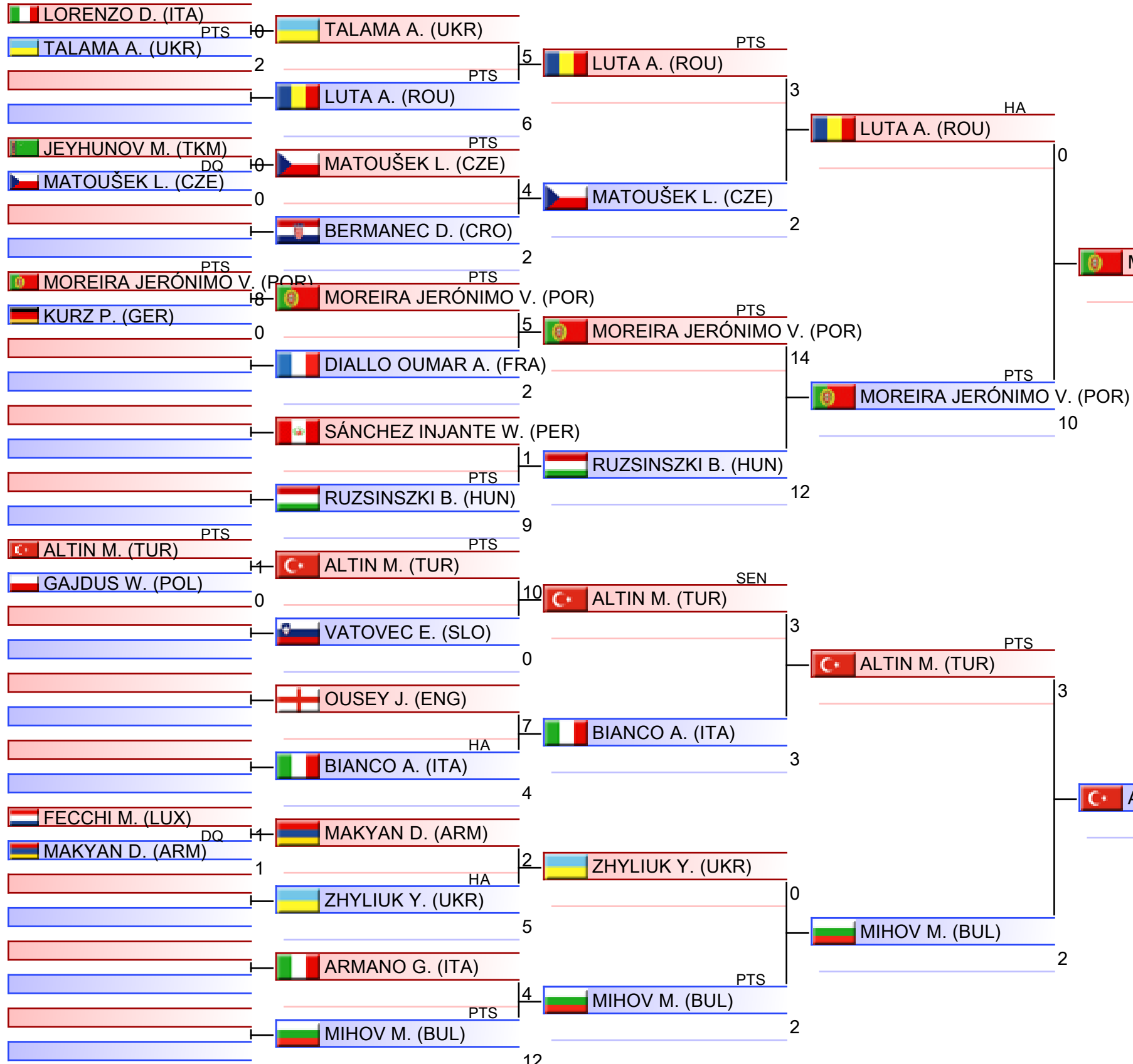

- | |
|--------------------------------|
| 1. KOZAK KOSTIANTYN (UKR) |
| 2. RUZ LUIS (VEN) |
| 3. SLUKIC PETAR (CRO) |
| 3. GIULIANO SIMONE (ITA) |
| 5. PIERANTONI MATTEO (LUX) |
| 5. ALTIN MUHAMMET EMIR (TUR) |
| 7. KARAGA ZIJAD (BIH) |
| 7. PIEKHTIERIEV MYKHAILO (UKR) |

Cadet Kumite Male -70 kg

Karate1 Youth League - Venice 2024, PALAZZO DEL TURISMO, Piazza Brescia 11, 30016 Lido di Jesolo VE, ITA

2024-12-07

Tatami
7 11:10

Pool
3/4

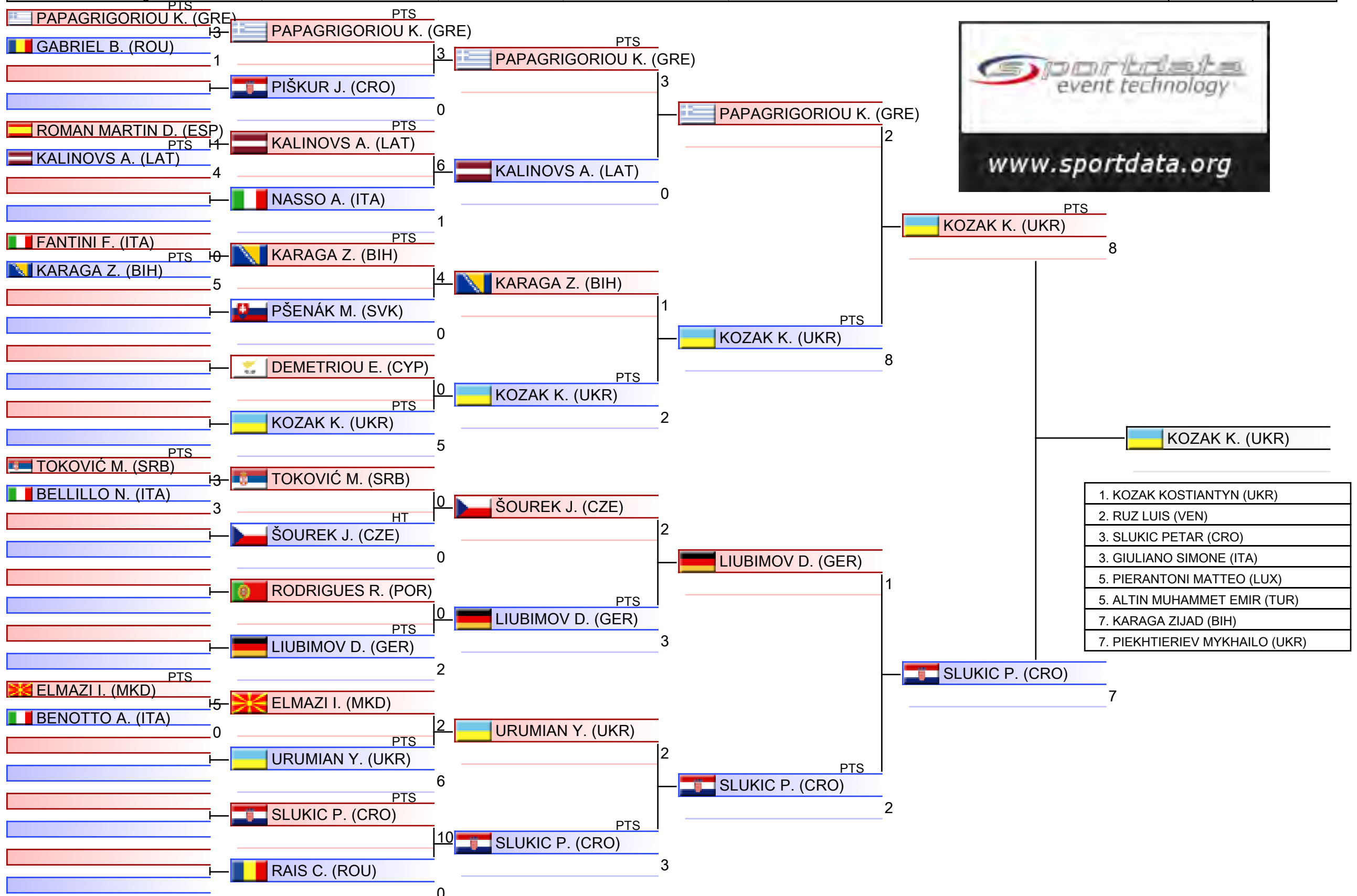

Cadet Kumite Male -70 kg

Karate1 Youth League - Venice 2024, PALAZZO DEL TURISMO, Piazza Brescia 11, 30016 Lido di Jesolo VE, ITA

2024-12-07

Tatami
8 11:10

Pool
4/4

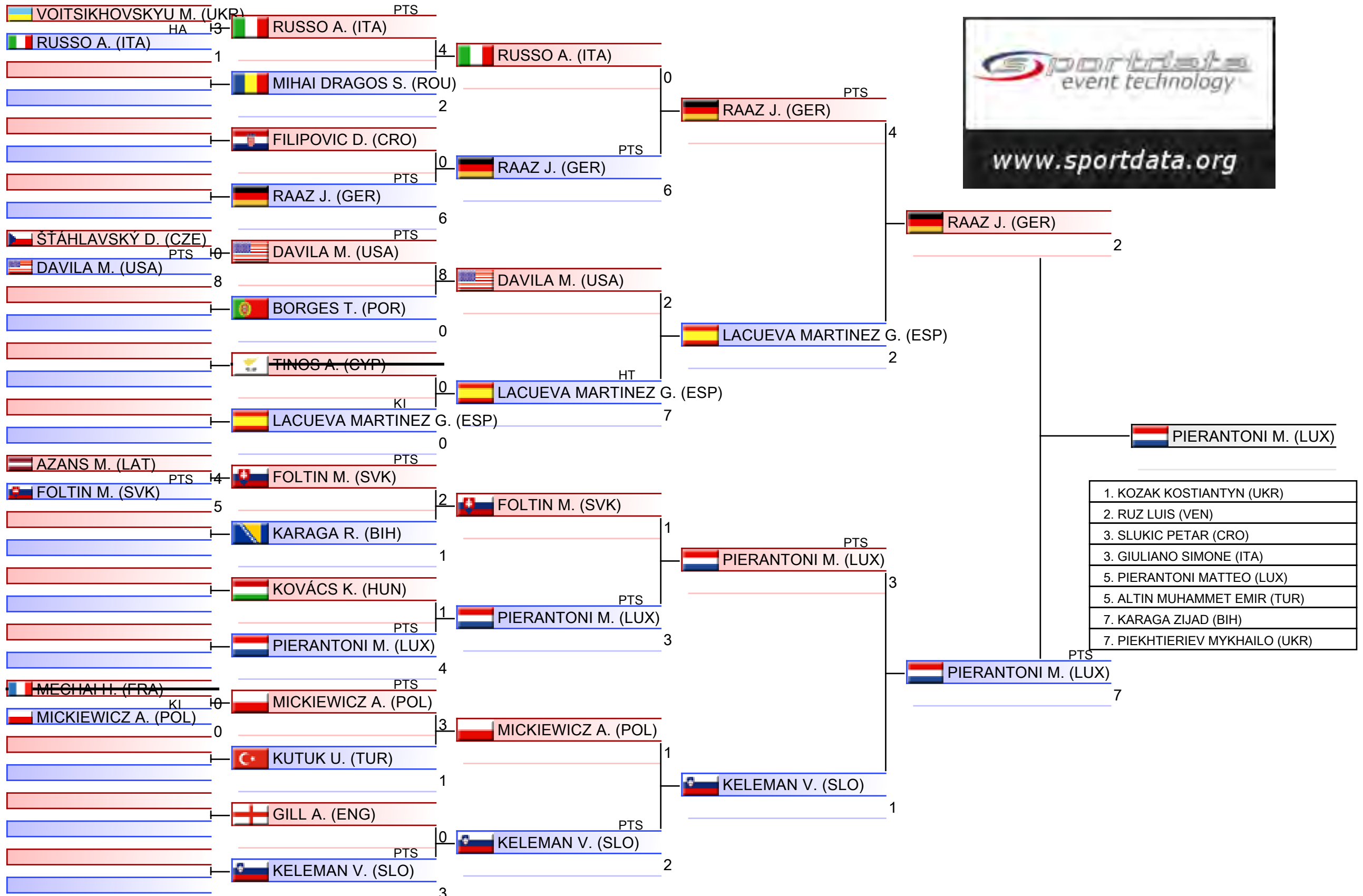

1. KOZAK KOSTIANTYN (UKR)
2. RUZ LUIS (VEN)
3. SLUKIC PETAR (CRO)
3. GIULIANO SIMONE (ITA)
5. PIERANTONI MATTEO (LUX)
5. ALTIN MUHAMMET EMIR (TUR)
7. KARAGA ZIJAD (BIH)
7. PIEKHTIERIEV MYKHAILO (UKR)

Pool winner-Cadet Kumite Male -70 kg

Karate1 Youth League - Venice 2024, PALAZZO DEL TURISMO, Piazza Brescia 11, 30016 Lido di Jesolo VE, ITA

2024-12-07

Tatami

5 13:00

Pool

1/1

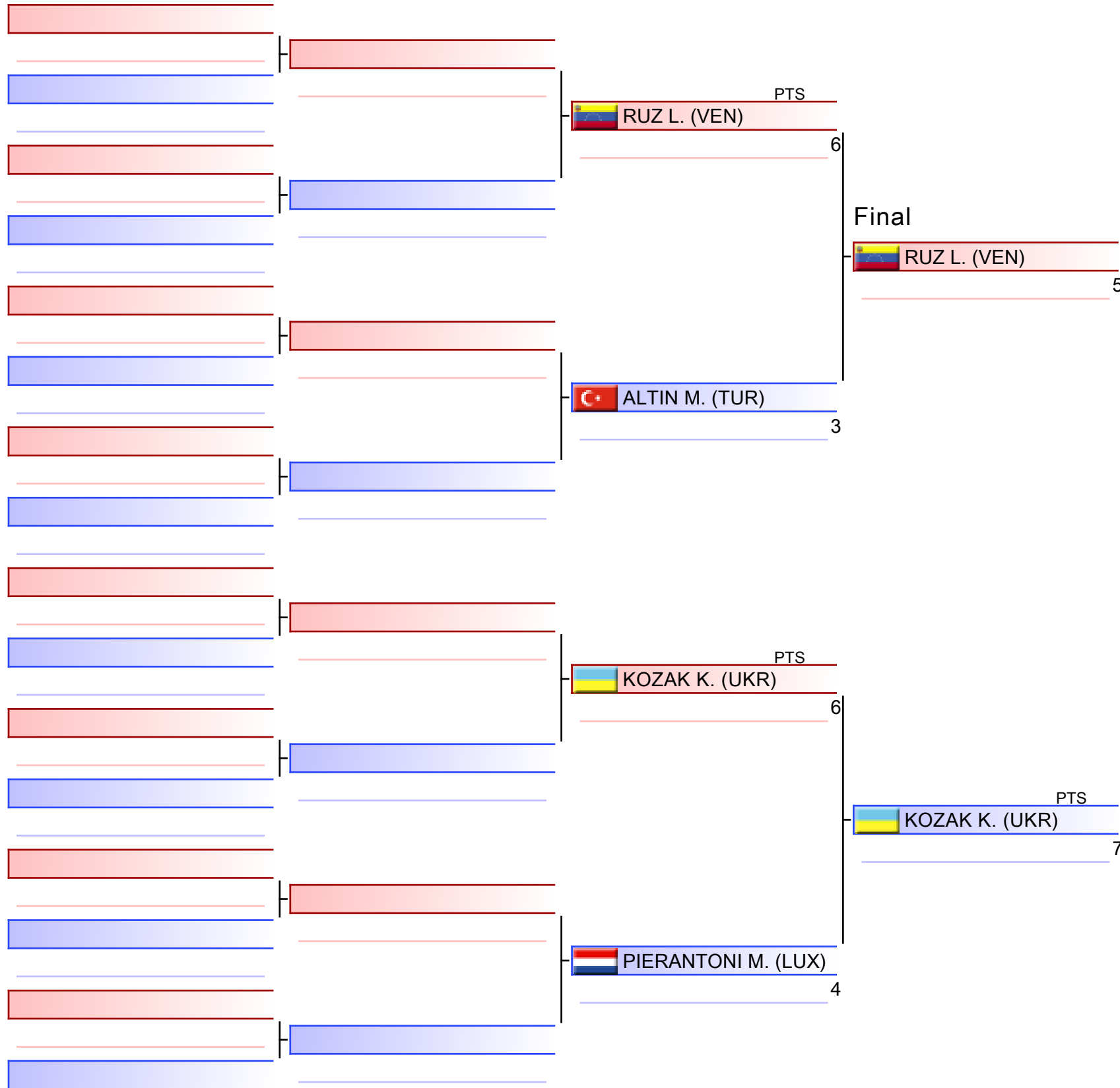

KOZAK K. (UKR)

1. KOZAK KOSTIANTYN (UKR)
2. RUZ LUIS (VEN)
3. SLUKIC PETAR (CRO)
3. GIULIANO SIMONE (ITA)
5. PIERANTONI MATTEO (LUX)
5. ALTIN MUHAMMET EMIR (TUR)
7. KARAGA ZIJAD (BIH)
7. PIEKHTIERIEV MYKHAILO (UKR)

Cadet Kumite Male -70 kg

Karate1 Youth League - Venice 2024

2024-12-07

Tatami

4 15:15

Pool

1,2,3,4

(c)sportdata GmbH & Co KG 2000-2024 (2024-12-08 20:16) v 10.2.0 build 1 (2024-11-20 00:58 CET) License: SDIL TVG (expire 2025-01-26)

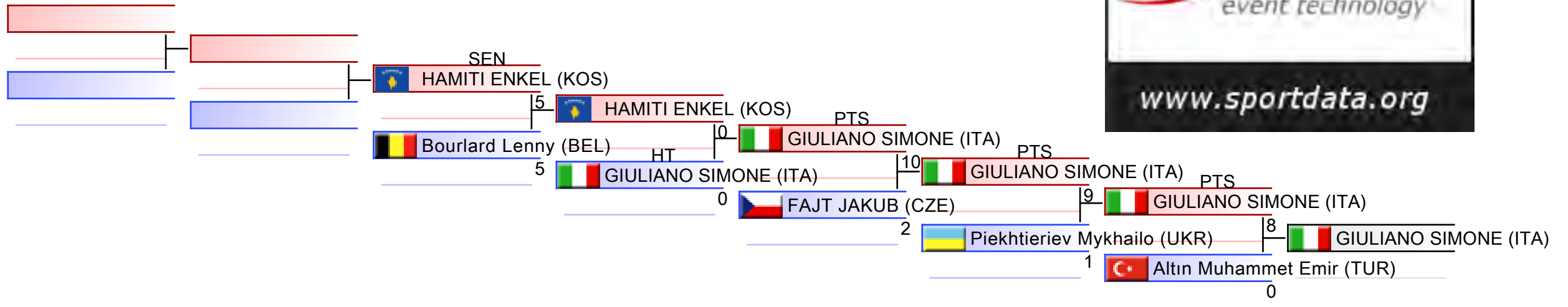

REPECHAGE: (1,2,3,4)

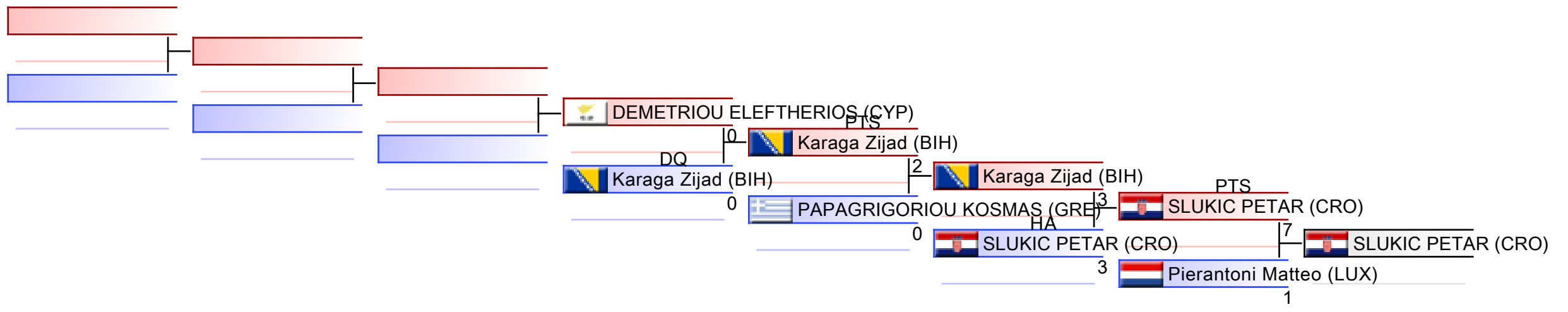



Karate1 Youth League - Venice 2024 - 2024-12-04



Official Results

Cadet Kumite Male -70 kg (Entries: 83 Nations: 33)			
1	KOZAK KOSTIANTYN		UKR - UKRAINE
2	RUZ LUIS		VEN - VENEZUELA
3	SLUKIC PETAR		CRO - CROATIA
3	GIULIANO SIMONE		ITA - ITALY
5	PIERANTONI MATTEO		LUX - LUXEMBOURG
5	ALTIN MUHAMMET EMIR		TUR - TURKIYE
7	KARAGA ZIJAD		BIH - BOSNIA AND HERZEGOVINA
7	PIEKHTIERIEV MYKHAILO		UKR - UKRAINE
9	PAPAGRIGORIOU KOSMAS		GRE - GREECE
9	FAJT JAKUB		CZE - CZECH REPUBLIC
11	DEMETRIOU ELEFThERIOS		CYP - CYPRUS
11	HAMITI ENKEL		KOS - KOSOVO
13	BOURLARD LENNY		BEL - BELGIUM

CADET KUMITE MALE 70+ KG



Karate1 Youth League - Venice 2024

ENTRIES BY WEIGHT CATEGORY



Cadet Kumite Male 70+ kg

As of 8 DEC 2024

Country Code	ID	Gender	Name	Seeding
AUS	AUS003076	M	UKPERAJ REGIS	
BEL		M	Lazaridis Panagiotis	
BEL		M	Tshibassu Elie Christopher	
BIH		M	Mosorović Vedad	
BIH		M	Selava Husein	
BIH		M	Spahic Belmin	
CHI		M	Codocedo Matias	
CRO		M	Laginja Josip	
CRO	SD77165	M	Lovrinović David	
CRO	CRO03487	M	Slišković Valentino	
CRO	CRO03489	M	SOLTIC ERVIN	
CYP		M	NECULAI FLAVIUS LUCIAN	
CZE		M	DOBROZEMSKÝ Lukáš	
CZE		M	Jindra Daniel	
CZE		M	Palan Martin	
CZE		M	Vitasek Lukas	
ENG		M	Fayik Louie	
ENG	SD60793	M	Hasib Sameer	
ENG		M	Newman Zachary	
ESP	SD74628	M	Mazo Marco	
FRA		M	Da Rocha nahel	
FRA		M	PILLANT Métis	
GER		M	PARKHOMENKO ARTEM	
GER		M	Schmidtgen Aurel	
GRE	GRE03883	M	ZORPIDIS ANGELOS	
HKG	HKG02712	M	LUI TO MING	
HUN		M	Bálint Gombkötő	
HUN		M	Bartalis Ádám	
HUN		M	Kökény Kiss Péter	
HUN		M	Piry Péter	
IRI		M	Zeinali shalmaei Amir sam	
ITA		M	ANGEI FERRARIO LUCA	
ITA		M	BERLUSCONI DAVIDE	
ITA		M	Conti Alessandro	
ITA		M	DEL SEPPIA GIACOMO	
ITA		M	De Rosa Emanuele	
ITA		M	ESPOSITO Nicola	
ITA		M	FALCETTA ANDREA	
ITA		M	FASTIGARI VALERIO LUIGI	
ITA	SD40336	M	Ferrarini Francesco	
ITA		M	INCOLLINGO ANGELO MATTEO	
ITA		M	Magri Matteo	
ITA		M	Marinone Lorenzo	
ITA		M	MONTANARI VITO	
ITA		M	Nuzzi Giuseppe	



Karate1 Youth League - Venice 2024

ENTRIES BY WEIGHT CATEGORY



Cadet Kumite Male 70+ kg

As of 8 DEC 2024

Country Code	ID	Gender	Name	Seeding
ITA		M	PAKOCS PATRICK	
ITA		M	Quaranta Simonluca	
ITA		M	Redondi Alessandro	
ITA		M	Righetti Simone	
ITA		M	ROMANO GABRIELE	
ITA		M	TORTELLI LEONARDO	
ITA		M	Vecchiotti Riccardo	
KOS	KOS02865	M	BAHTIRI RION	
LAT		M	Durens Eduards	
LAT		M	Paiders Gustavs Patriks	
MDA	MDA02453	M	CUCUL SAVELII	
NED	SD49458	M	Blumink Levy	
POL	POL3965	M	PRZASNYSKI MICHAL	
POR		M	Aguiar André	
POR		M	Emídio Abel	
ROU	ROU003971	M	ANDREI ANGIU	
ROU	ROU03242	M	IGARELU VICTOR	
ROU	ROU03757	M	ROSESCU VLAD	
ROU	ROU03722	M	TUDOR LEONARD	
SEN	SEN002724	M	TOURE MOUHAMADOU BACHIR	
SLO	SLO2353	M	OCKO GAL	
SRB		M	Andonov Nikola	
SVK		M	Krajčík Filip	
SVK		M	Mitrik Richard	
SVK		M	Naňo Tomáš	
TUR		M	Karakozak Nadir efe	
TUR		M	YAĞLI KAYRA	
UKR		M	KINASH YAROSLAV	
UKR		M	Remeslo Mykhaylo	
UKR		M	Rudenko Vladyslav	
UKR		M	Tyshchenko Danylo	
USA		M	Jackson Isaiah	
USA		M	Mujat Doru	

Cadet Kumite Male 70+ kg

Karate1 Youth League - Venice 2024, PALAZZO DEL TURISMO, Piazza Brescia 11, 30016 Lido di Jesolo VE, ITA

2024-12-07

Tatami
1 13:25

Pool
1/4

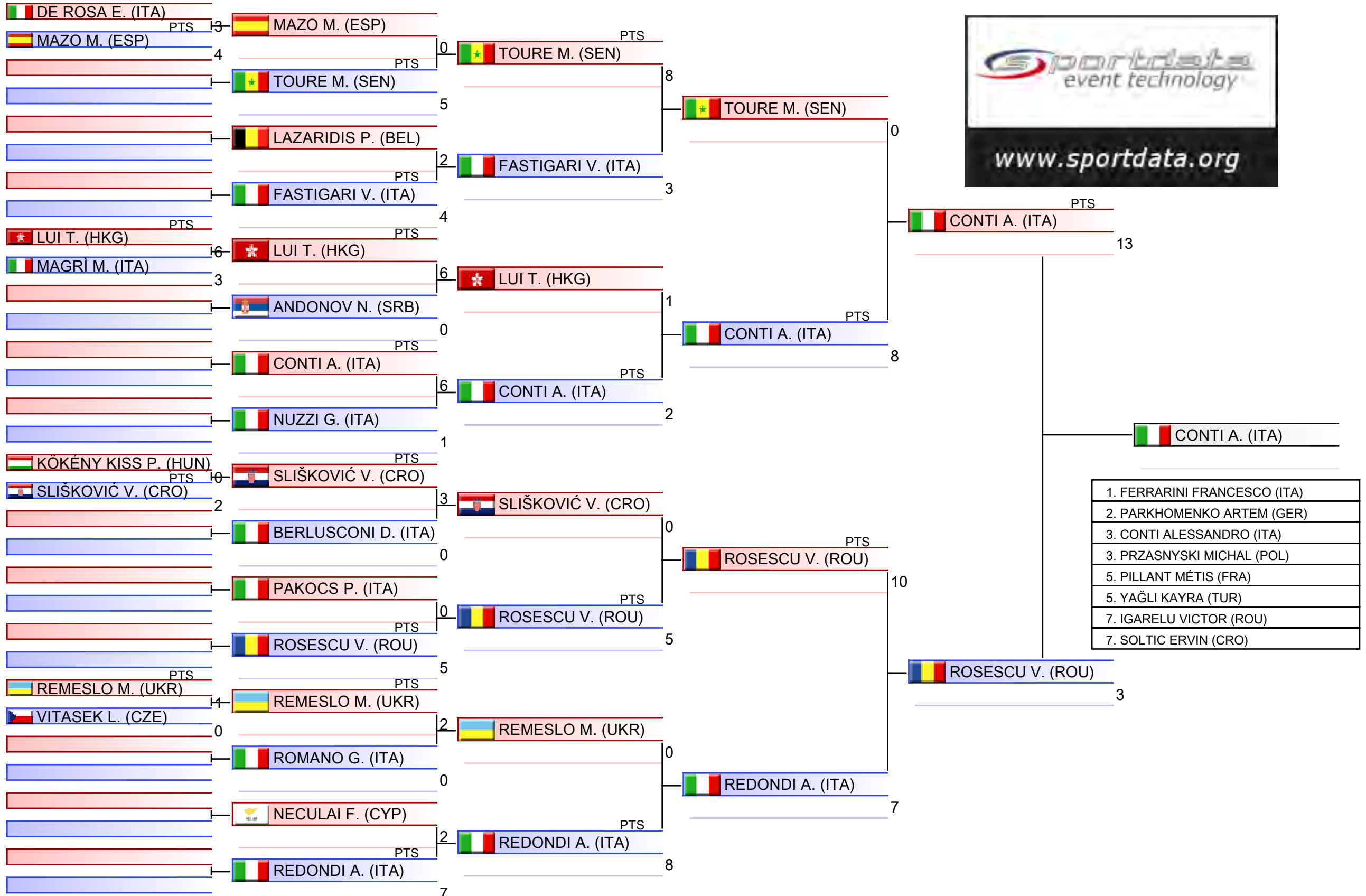

1. FERRARINI FRANCESCO (ITA)
2. PARKHOMENKO ARTEM (GER)
3. CONTI ALESSANDRO (ITA)
3. PRZASNYSKI MICHAL (POL)
5. PILLANT MÉTIS (FRA)
5. YAĞLI KAYRA (TUR)
7. IGARELU VICTOR (ROU)
7. SOLTIC ERVIN (CRO)

Cadet Kumite Male 70+ kg

Karate1 Youth League - Venice 2024, PALAZZO DEL TURISMO, Piazza Brescia 11, 30016 Lido di Jesolo VE, ITA

2024-12-07

Tatami
2 13:25

Pool
2/4

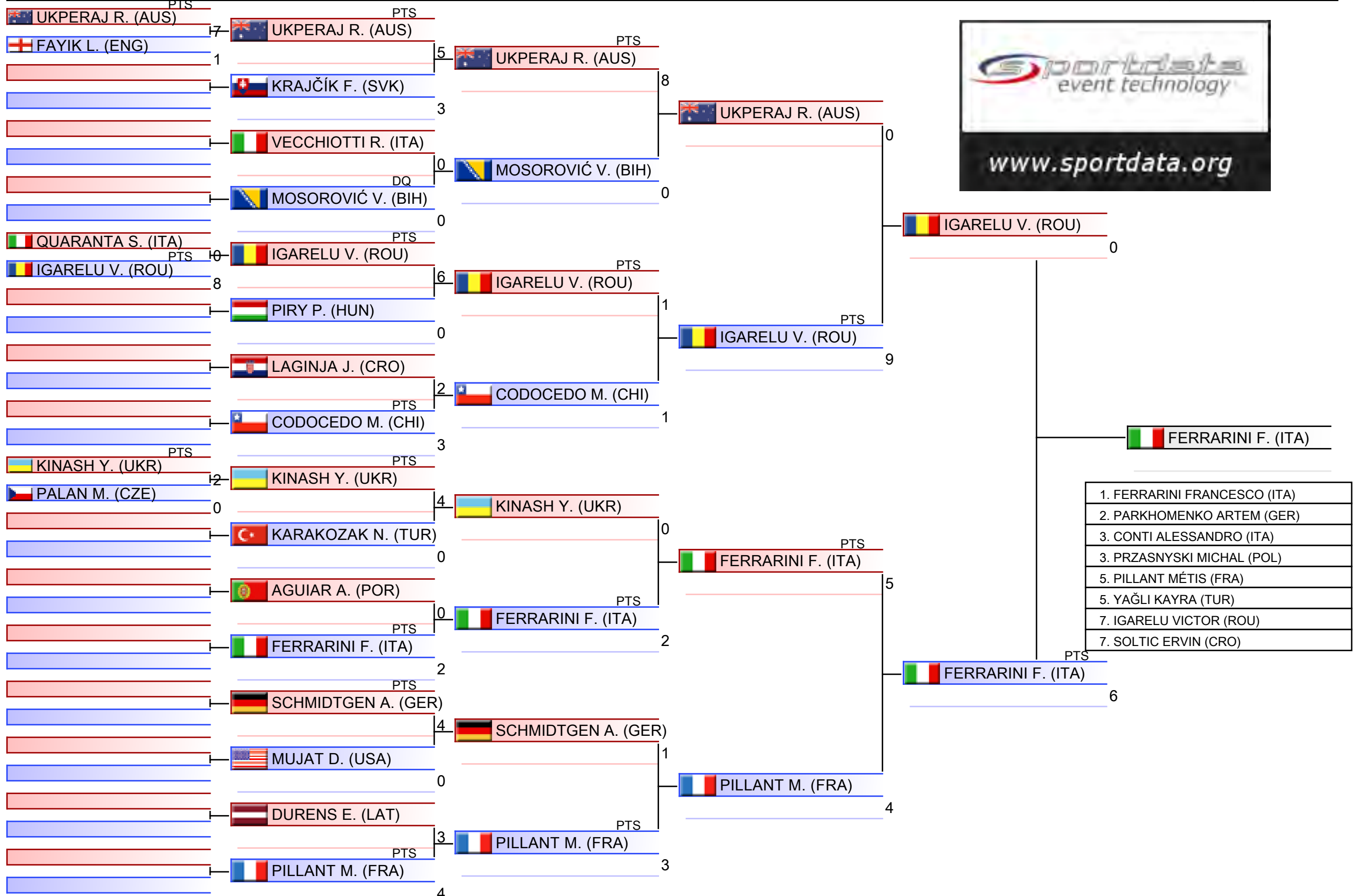

1.	FERRARINI FRANCESCO (ITA)
2.	PARKHOMENKO ARTEM (GER)
3.	CONTI ALESSANDRO (ITA)
3.	PRZASNYSKI MICHAL (POL)
5.	PILLANT MÉTIS (FRA)
5.	YAĞLI KAYRA (TUR)
7.	IGARELU VICTOR (ROU)
7.	SOLTIC ERVIN (CRO)

Cadet Kumite Male 70+ kg

Karate1 Youth League - Venice 2024, PALAZZO DEL TURISMO, Piazza Brescia 11, 30016 Lido di Jesolo VE, ITA

2024-12-07

Tatami
3 13:25

Pool
3/4

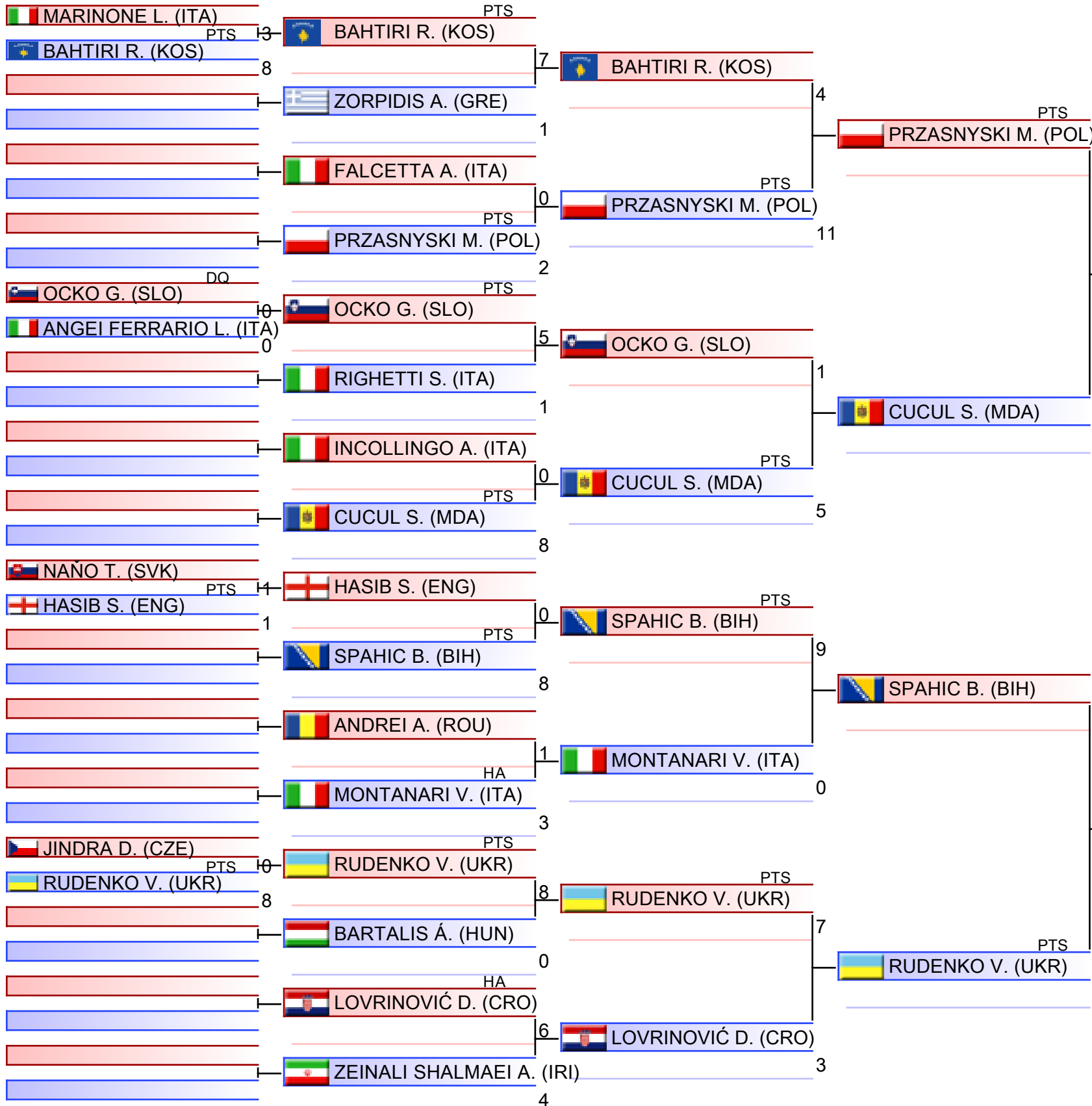

1. FERRARINI FRANCESCO (ITA)
2. PARKHOMENKO ARTEM (GER)
3. CONTI ALESSANDRO (ITA)
3. PRZASNYSKI MICHAL (POL)
5. PILLANT MÉTIS (FRA)
5. YAĞLI KAYRA (TUR)
7. IGARELU VICTOR (ROU)
7. SOLTIC ERVIN (CRO)

Cadet Kumite Male 70+ kg

Karate1 Youth League - Venice 2024, PALAZZO DEL TURISMO, Piazza Brescia 11, 30016 Lido di Jesolo VE, ITA

2024-12-07

Tatami
4 13:25

Pool
4/4

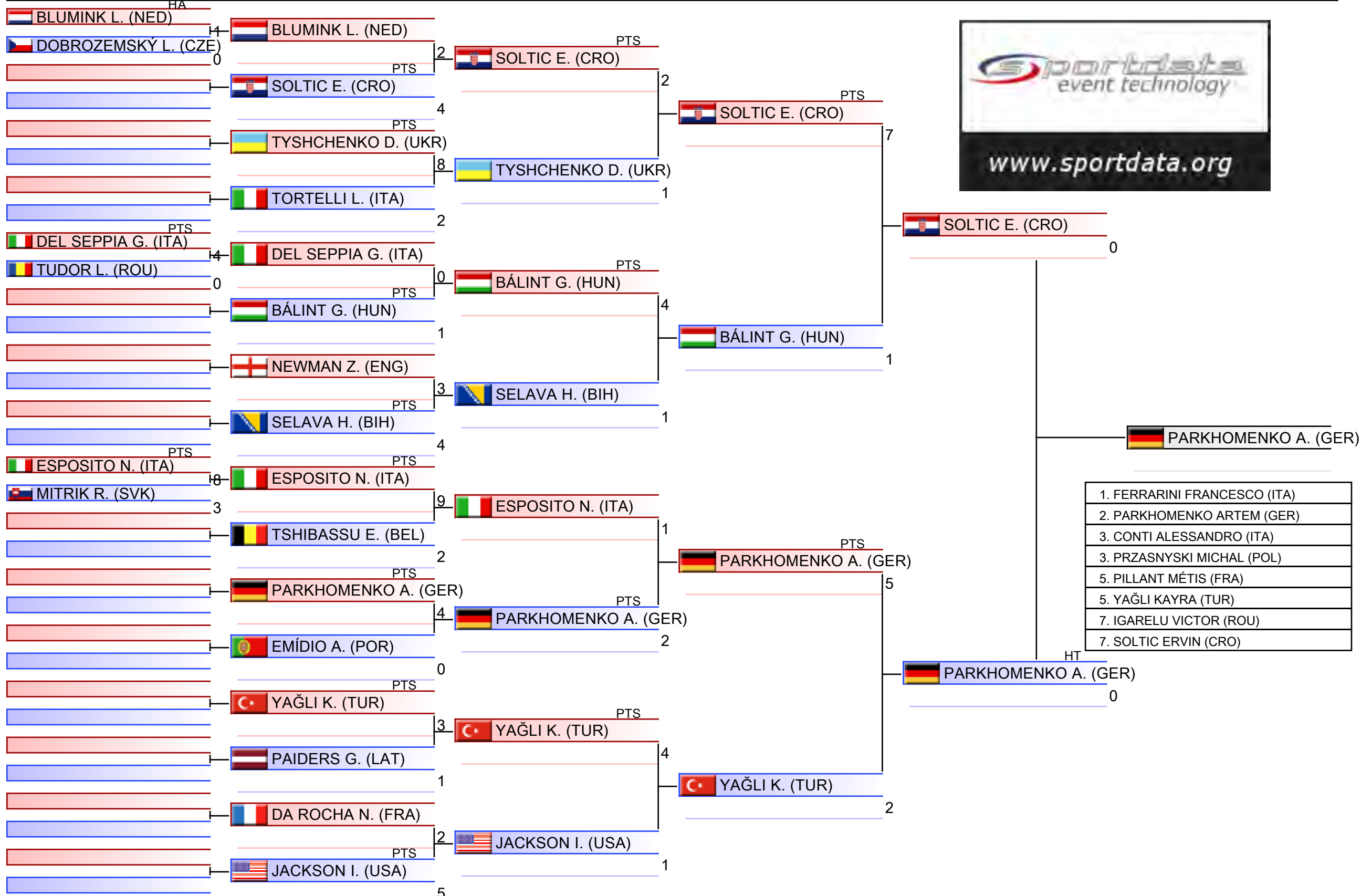

1. FERRARINI FRANCESCO (ITA)
2. PARKHOMENKO ARTEM (GER)
3. CONTI ALESSANDRO (ITA)
3. PRZASNYSKI MICHAL (POL)
5. PILLANT MÉTIS (FRA)
5. YAĞLI KAYRA (TUR)
7. IGARELU VICTOR (ROU)
7. SOLTIC ERVIN (CRO)

Pool winner-Cadet Kumite Male 70+ kg

Karate1 Youth League - Venice 2024, PALAZZO DEL TURISMO, Piazza Brescia 11, 30016 Lido di Jesolo VE, ITA

2024-12-07

Tatami
1 15:10

Pool
1/1

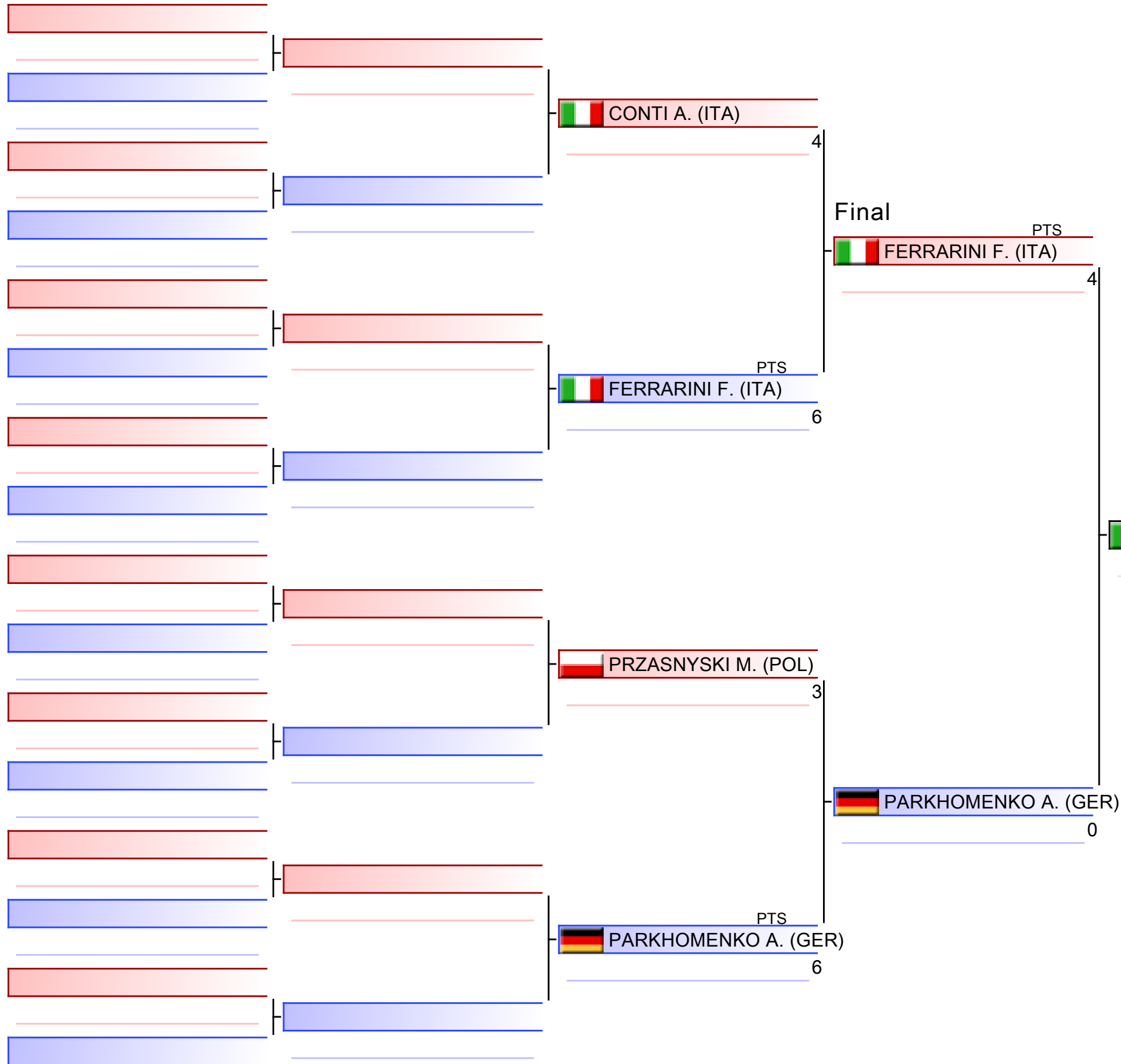

FERRARINI F. (ITA)

1. FERRARINI FRANCESCO (ITA)
2. PARKHOMENKO ARTEM (GER)
3. CONTI ALESSANDRO (ITA)
3. PRZASNYSKI MICHAL (POL)
5. PILLANT MÉTIS (FRA)
5. YAĞLI KAYRA (TUR)
7. IGARELU VICTOR (ROU)
7. SOLTIC ERVIN (CRO)

Cadet Kumite Male 70+ kg

Karate1 Youth League - Venice 2024

2024-12-07

Tatami
6 19:00

Pool
1,2,3,4

(c)sportdata GmbH & Co KG 2000-2024 (2024-12-08 20:16) v 10.2.0 build 1 (2024-11-20 00:58 CET) License: SDIL TVG (expire 2025-01-26)

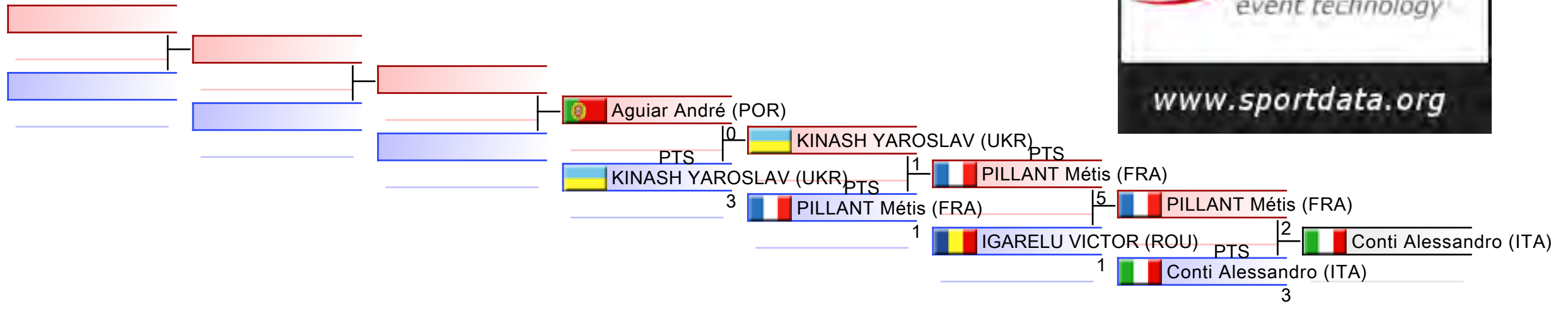

REPECHAGE: (1,2,3,4)

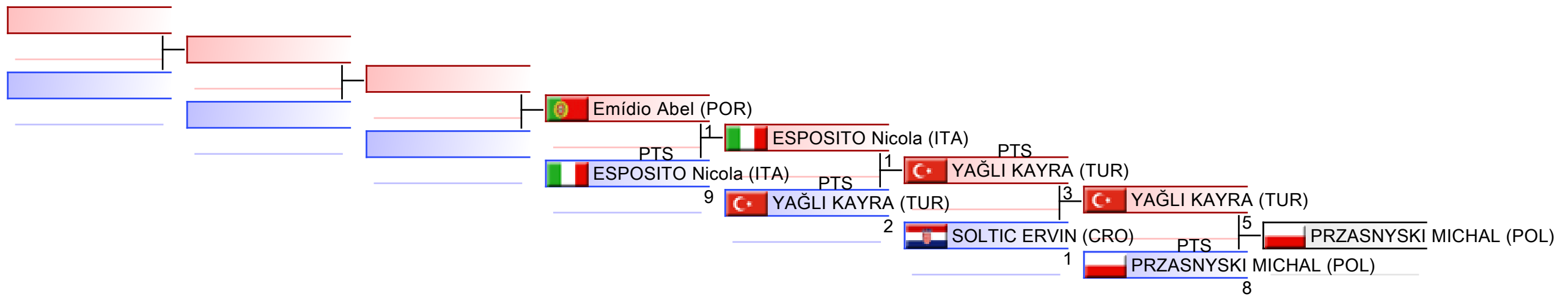



Karate1 Youth League - Venice 2024 - 2024-12-04



Official Results

Cadet Kumite Male 70+ kg (Entries: 78 Nations: 30)			
1	FERRARINI FRANCESCO		ITA - ITALY
2	PARKHOMENKO ARTEM		GER - GERMANY
3	CONTI ALESSANDRO		ITA - ITALY
3	PRZASNYSKI MICHAL		POL - POLAND
5	PILLANT MÉTIS		FRA - FRANCE
5	YAĞLI KAYRA		TUR - TURKIYE
7	IGARELU VICTOR		ROU - ROMANIA
7	SOLTIC ERVIN		CRO - CROATIA
9	KINASH YAROSLAV		UKR - UKRAINE
9	ESPOSITO NICOLA		ITA - ITALY
11	AGUIAR ANDRÉ		POR - PORTUGAL
11	EMÍDIO ABEL		POR - PORTUGAL

JUNIOR KATA FEMALE



Karate1 Youth League - Venice 2024

ENTRIES BY WEIGHT CATEGORY



Junior Kata Female

As of 8 DEC 2024

Country Code	ID	Gender	Name	Seeding
AUT	AUT03046	F	Maly Riana	
BEL		F	Henroteaux Lou	
BEL		F	LENARTZ Maeva	
BEL		F	MILER Gelsey	
BIH		F	Salihovic Aldijana	
BUL	BUL02458	F	KOSTOVA VELIZARA	
CAN		F	Lee Amanda	
CHI	CHI02935	F	BARRIA ALCARAZ ALLIS VIVIANE	
COL	COL003104	F	Jaramillo Mariana	
CRO	CRO03016	F	Baric Antonija	
CRO		F	BRINC TEA	
CRO		F	Erak Laura	
CRO		F	Horvatović Nikolina	
CRO		F	MIKULIĆ BELLA	
CZE	CZE02429	F	BIRIUCOVA TAISA	
CZE	CZE2728	F	Kirschnerová Silvie Ella	
CZE	CZE02535	F	Kubinova Anna	
CZE	CZE02610	F	MALAFOVA NATALIE	
CZE	CZE02477	F	NOVAKOVA KATERINA	
CZE		F	Pavlasová Linda	
CZE	CZE02534	F	Veselíková Riana	
ENG		F	Cartwright Coni-Mae	
ENG		F	Dixon Amy	
ENG	SD65919	F	Melton Lilly	
ESA	ESA002425	F	CERROS ELENA ISABEL	
ESP		F	ANGUERA NIETO JUDITH	
ESP		F	DURÁN PAVÓN EVA	
ESP		F	Mallegni Marta	
ESP	ESP03480	F	PALLEIRO CARBALLO BEATRIZ	
FIN		F	Kuusi Nika	
FRA		F	BAUDARD LAURE	
FRA		F	BOUTELIOUA Mélissa	
FRA		F	CAPET LOUISE	
FRA	SD72463	F	DRUJON Maelle	
FRA		F	Entem Maëlla	
FRA	SD59651	F	HERRMANN ADELIA	
FRA		F	Marmotte Clara	
FRA	FRA03516	F	Ordonez Ines	
FRA	FRA03840	F	VAUCELLE-SPELLE Ninon	
FRA		F	VUILLEMIN Mailyynn	
GER		F	Bobbert Aitana	
GER	GER03868	F	EWALD CLARA	
GER		F	Födisch Jessica	
GER	GER03126	F	JAY SHIRLEY	
GER		F	Poh Nadine	



Karate1 Youth League - Venice 2024

ENTRIES BY WEIGHT CATEGORY



Junior Kata Female

As of 8 DEC 2024

Country Code	ID	Gender	Name	Seeding
GER		F	Witte Franziska	
GRE	GRE02495	F	TSIAKMAKI ATHINA	
HUN		F	Fodor Amira	
ITA	ITA04437	F	BACCHINI CHIARA	
ITA		F	BELLARDI MARIA SOFIA	
ITA		F	BENCIVENGA FRANCESCA	
ITA		F	BUGINI ALICE	
ITA		F	Ciocchetti Andreina	
ITA		F	Coselli Linda	
ITA	ITA2181	F	Crucitti Francesca	
ITA		F	Di Rosa Rossella Benedetta	
ITA	ITA04188	F	dominici roberta	
ITA	SD47416	F	Dublino Sofia	
ITA		F	FERRA EMMA	
ITA	ITA04406	F	FORCELLA ELEONORA	
ITA	SD66323	F	GABRIELE MIRIAM ELENA	
ITA		F	GATTA LINDA	
ITA		F	GIOMBI SOFIA	
ITA	ITA04253	F	Grazia Nicol	
ITA		F	Lazzari Siria	
ITA		F	MACHETTI IRENE	
ITA	ITA04438	F	MARCONI MARIA	
ITA		F	MATTUGINI ESTER	
ITA		F	MORETTI ELENA MARIA	
ITA		F	ORSETTI ANNA	
ITA	ITA04248	F	PADOAN MARTINA	
ITA		F	PARIMBELLI CAROLINA	
ITA	SD52109	F	Preda Giada	
ITA		F	Punta Micaela	
ITA		F	Rovina Lisa	
ITA		F	Sacson Arianna	
ITA	ITA04458	F	Scaruffi Sara	
ITA		F	SELVA Sofia	
ITA		F	Tagliabue Silvia	
ITA	SD66345	F	TOGNETTI MARIA CHIARA	
ITA		F	VILLA MARTINA	
JPN		F	SHINJO RINZE	
KOR	KOR02351	F	CHOI HAEUN	
LUX	LUX02275	F	Rodrigo Sarah	
MDA	MDA02413	F	SERBUL ALEXANDRINA	
MLT	MLT02318	F	CONTI JADE	
MLT	MLT02241	F	ROADLEY-BATTIN EVIE	
MLT	MLT02201	F	SALIBA FRANCESCA	
MNE		F	MILIĆ JOVANA	
PER		F	Barrios Inga Damaris Gabriela	



Karate1 Youth League - Venice 2024

ENTRIES BY WEIGHT CATEGORY



Junior Kata Female

As of 8 DEC 2024

Country Code	ID	Gender	Name	Seeding
POL	POL3257	F	NOWAK WIKTORIA	
POL	POL3033	F	WOJDA LENA	
POL	POL2854	F	WYSOCKA EMILIA	
POR		F	Ferreira Anamar	
POR		F	Jacinto Madalena	
POR	POR02873	F	Marques Rita	
POR		F	Martins Júlia	
POR	SD59628	F	OLIVEIRA INÊS	
POR	POR003308	F	Pinto Isabela	
POR		F	Santos Joana	
ROU	ROU003849	F	ALEXIA TANASESCU	
SLO	SLO02926	F	KREGAR GABRIELA	
SLO	SLO2423	F	LISINOVIC ELMA	
SRB		F	Starčević Sara	
SUI		F	Eiselt Zoe	
SUI	SUI02740	F	Ritz Lila	
SVK		F	Fialková Sofia	
SVK	SVK02760	F	KADLECAJOVA Viktoria	
TPE	TPE02736	F	KUO EN-YU	
UKR	UKR03150	F	BARANOVA ULIANA	
UKR		F	Golod Anastasiia	
UKR	UKR03014	F	KHOLODNIAK DARIA	
UKR		F	Vynohradova Olha	
USA		F	Cottingham Emmersyn	
USA		F	Grzegorzewski Dayana	
WAL		F	Lewis Chloe	

Junior Kata Female

Karate1 Youth League - Venice 2024, PALAZZO DEL TURISMO, Piazza Brescia 11, 30016 Lido di Jesolo VE, ITA

2024-12-05

Tatami

1 09:00

Pool

1/8

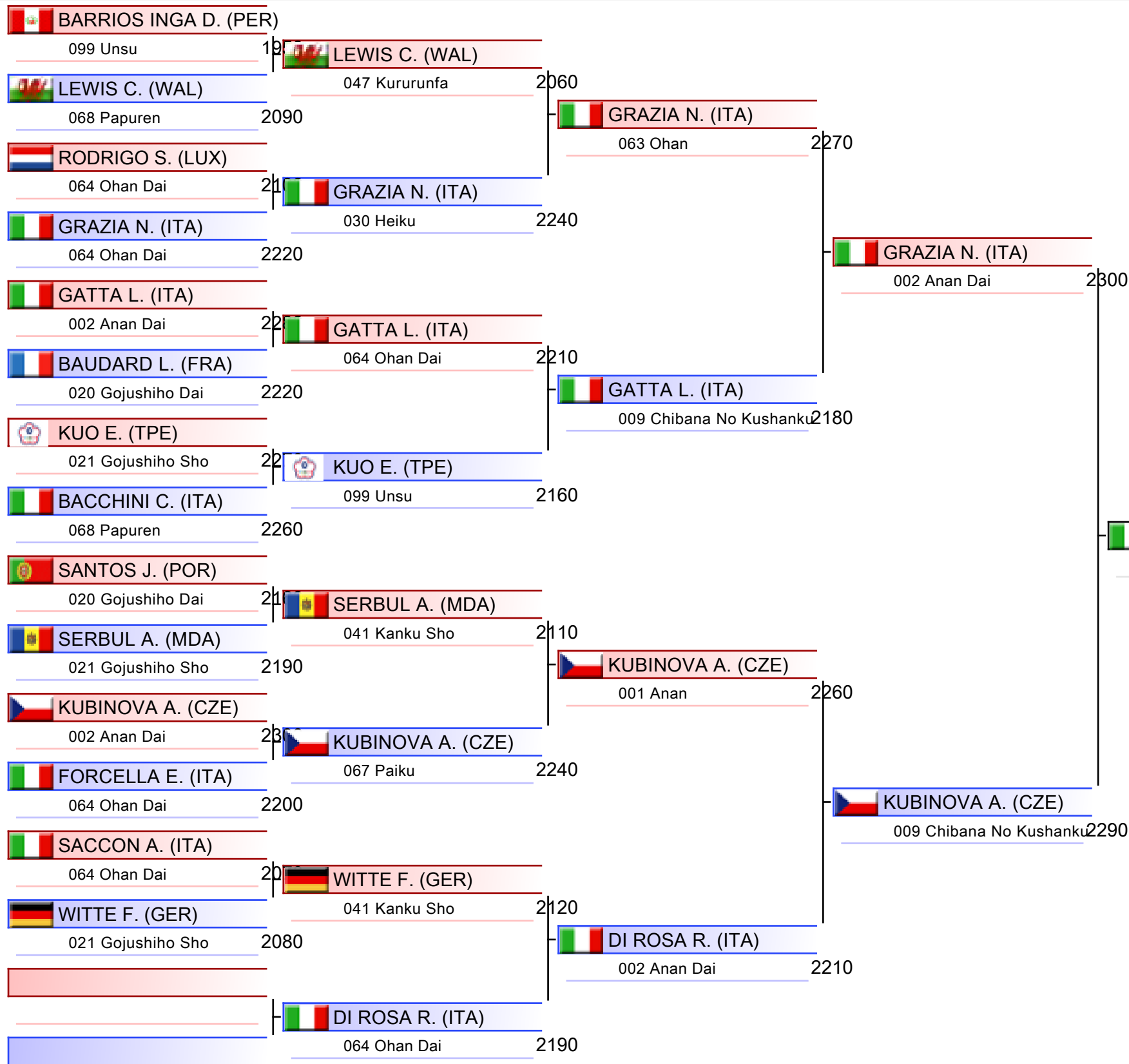

1. SHINJO RINZE (JPN)
2. ORDONEZ INES (FRA)
3. MARQUES RITA (POR)
3. RITZ LILA (SUI)
5. OLIVEIRA INÊS (POR)
5. MARCONI MARIA (ITA)
7. FIALKOVÁ SOFIA (SVK)
7. GRAZIA NICOL (ITA)

Junior Kata Female

Karate1 Youth League - Venice 2024, PALAZZO DEL TURISMO, Piazza Brescia 11, 30016 Lido di Jesolo VE, ITA

2024-12-05

Tatami
2 09:00

Pool
2/8

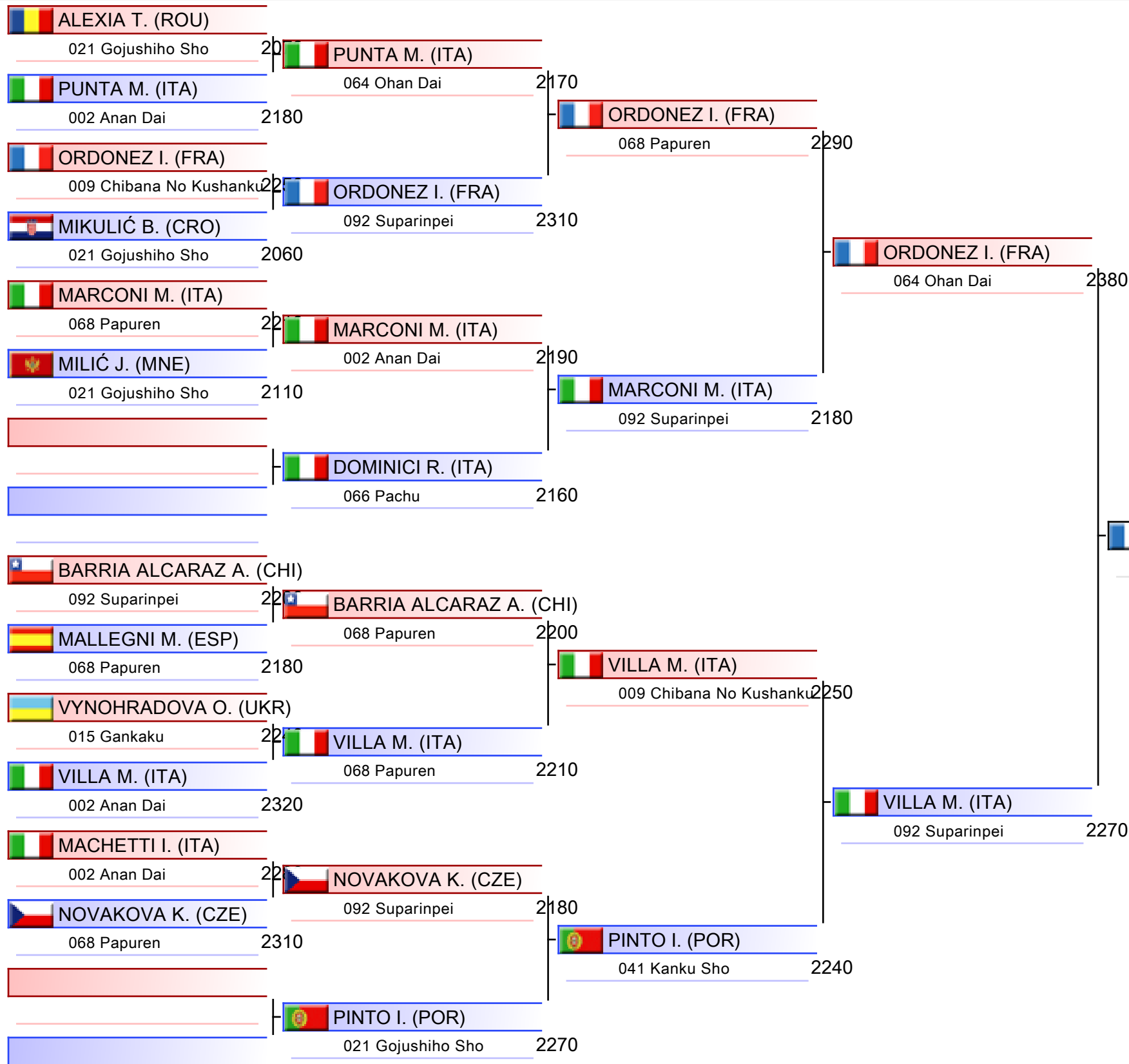

1. SHINJO RINZE (JPN)
2. ORDONEZ INES (FRA)
3. MARQUES RITA (POR)
3. RITZ LILA (SUI)
5. OLIVEIRA INÊS (POR)
5. MARCONI MARIA (ITA)
7. FIALKOVÁ SOFIA (SVK)
7. GRAZIA NICOL (ITA)

Junior Kata Female

Karate1 Youth League - Venice 2024, PALAZZO DEL TURISMO, Piazza Brescia 11, 30016 Lido di Jesolo VE, ITA

2024-12-05

Tatami
3 09:00

Pool
3/8

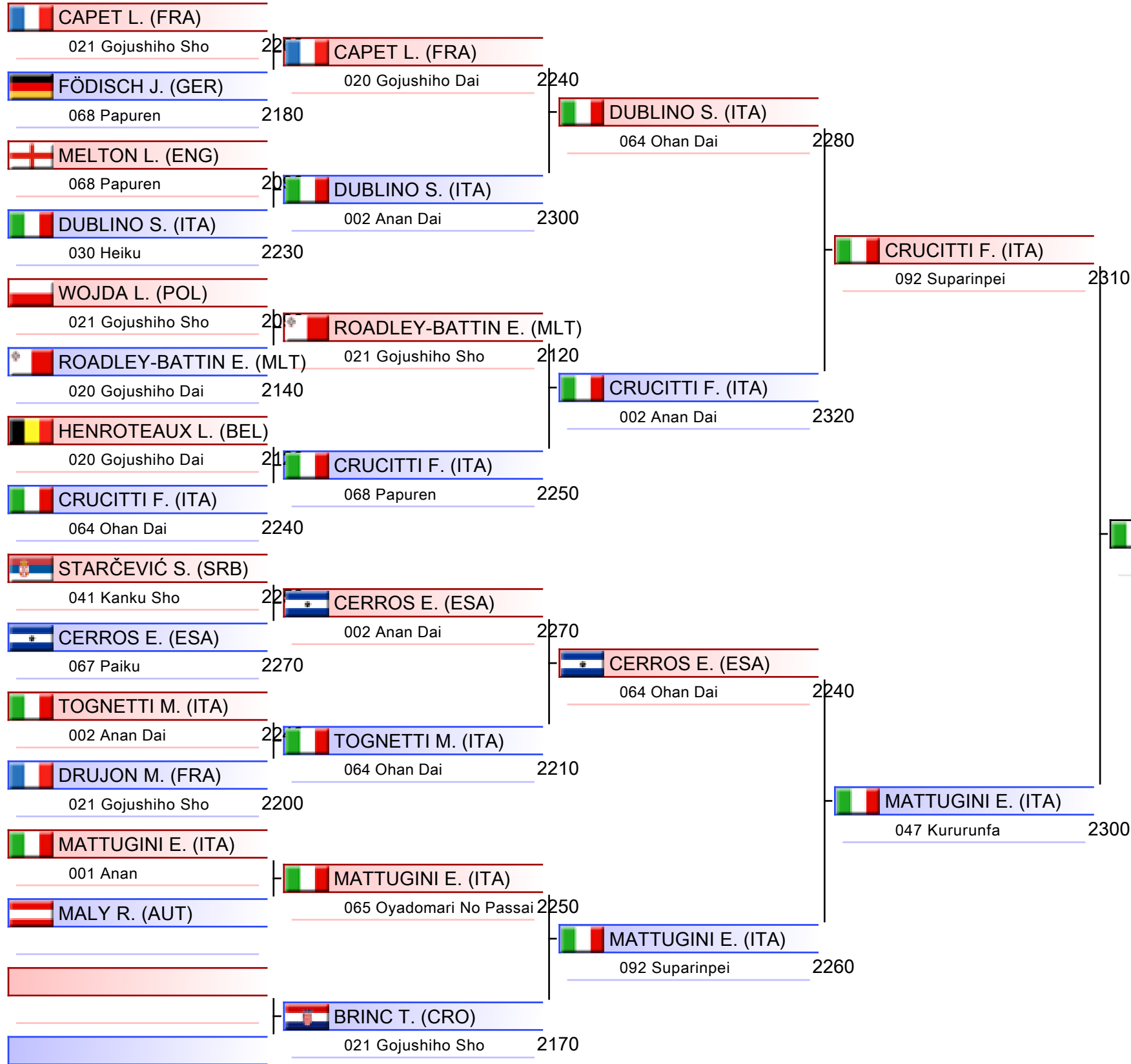

1. SHINJO RINZE (JPN)
2. ORDONEZ INES (FRA)
3. MARQUES RITA (POR)
3. RITZ LILA (SUI)
5. OLIVEIRA INÊS (POR)
5. MARCONI MARIA (ITA)
7. FIALKOVÁ SOFIA (SVK)
7. GRAZIA NICOL (ITA)

Junior Kata Female

Karate1 Youth League - Venice 2024, PALAZZO DEL TURISMO, Piazza Brescia 11, 30016 Lido di Jesolo VE, ITA

2024-12-05

Tatami

4 09:00

Pool

4/8

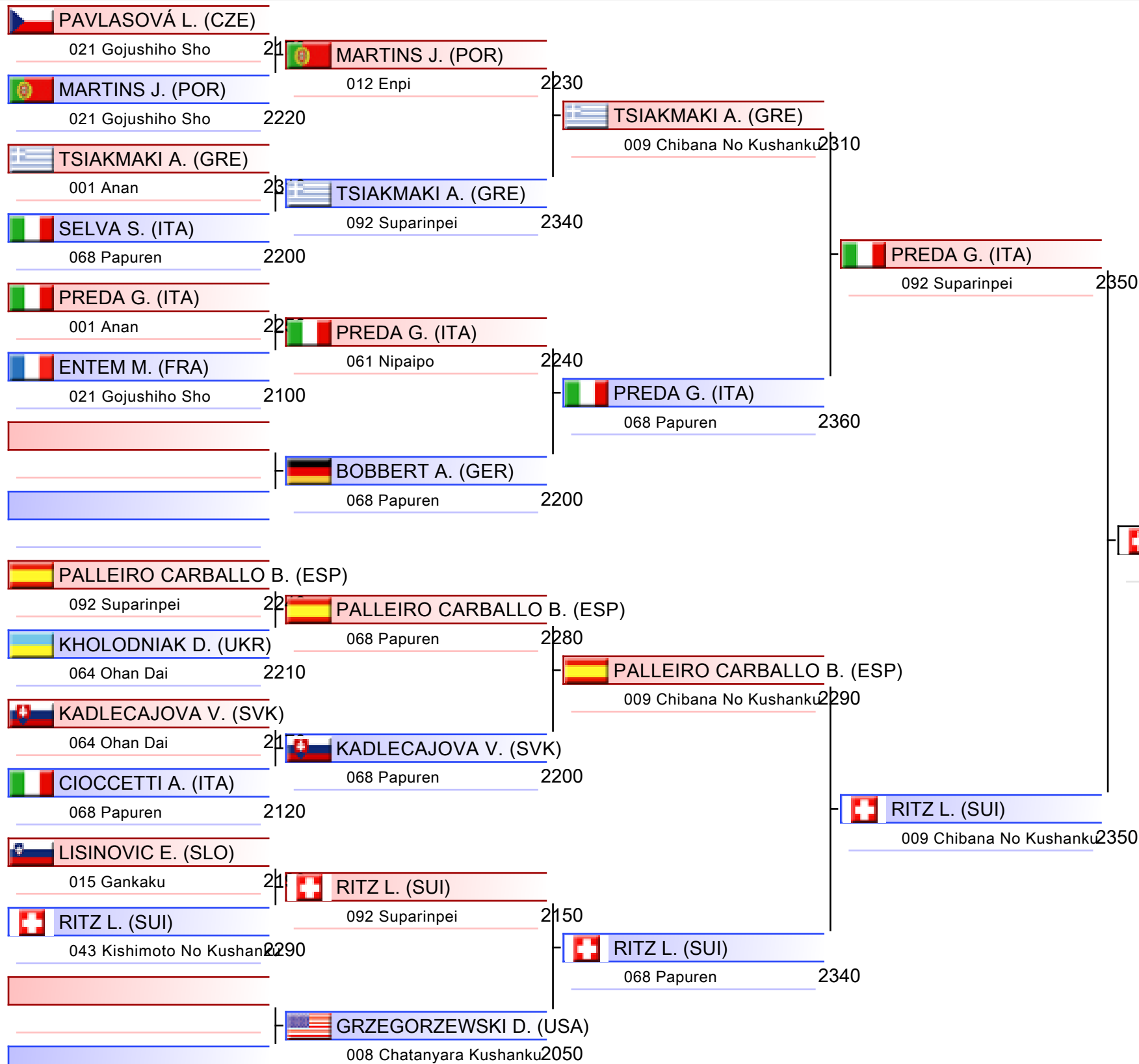

1. SHINJO RINZE (JPN)
2. ORDONEZ INES (FRA)
3. MARQUES RITA (POR)
3. RITZ LILA (SUI)
5. OLIVEIRA INÊS (POR)
5. MARCONI MARIA (ITA)
7. FIALKOVÁ SOFIA (SVK)
7. GRAZIA NICOL (ITA)

Junior Kata Female

Karate1 Youth League - Venice 2024, PALAZZO DEL TURISMO, Piazza Brescia 11, 30016 Lido di Jesolo VE, ITA

2024-12-05

Tatami
5 09:00

Pool
5/8

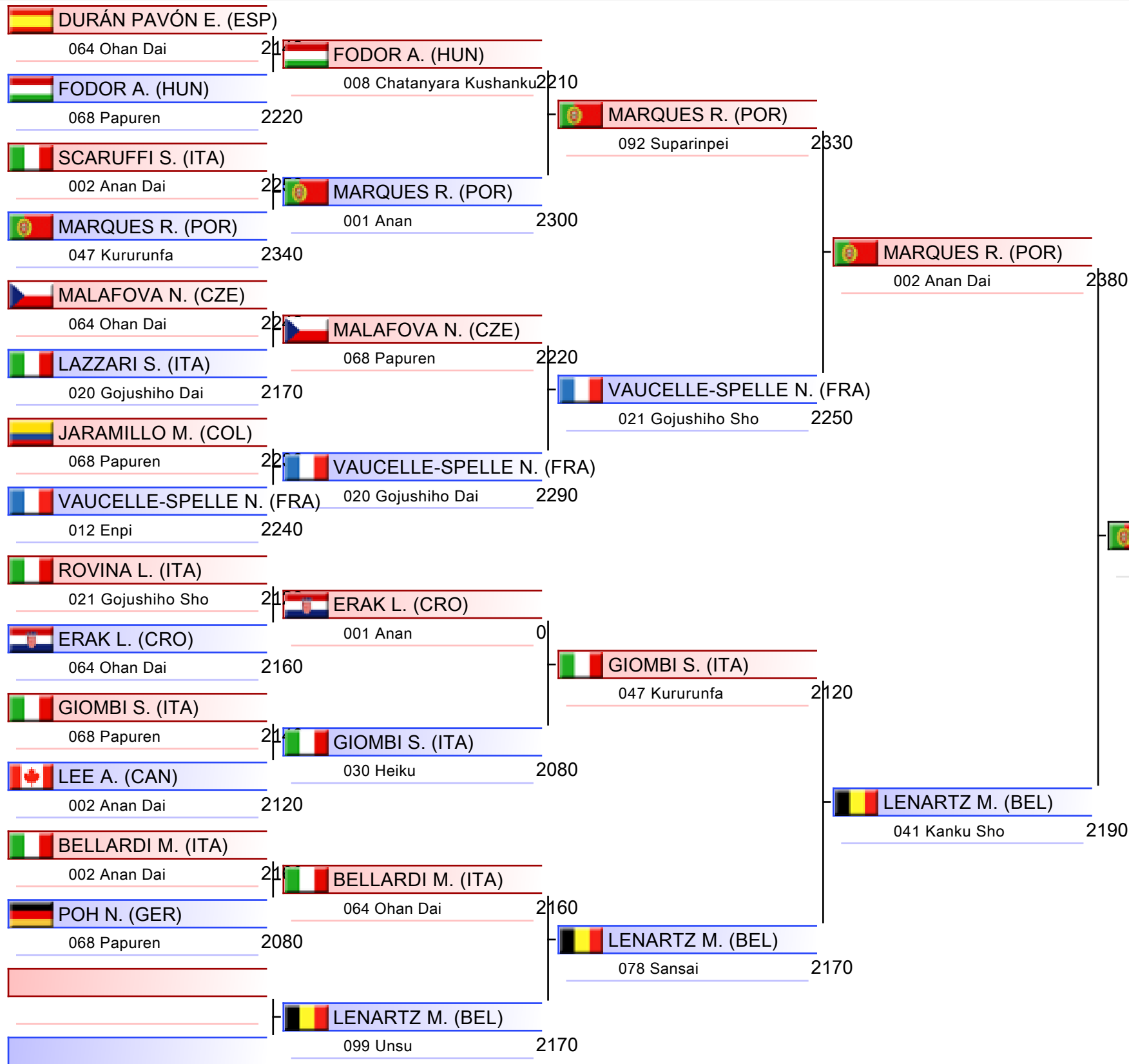

1. SHINJO RINZE (JPN)
2. ORDONEZ INES (FRA)
3. MARQUES RITA (POR)
3. RITZ LILA (SUI)
5. OLIVEIRA INÊS (POR)
5. MARCONI MARIA (ITA)
7. FIALKOVÁ SOFIA (SVK)
7. GRAZIA NICOL (ITA)

Junior Kata Female

Karate1 Youth League - Venice 2024, PALAZZO DEL TURISMO, Piazza Brescia 11, 30016 Lido di Jesolo VE, ITA

2024-12-05

Tatami
6 09:00

Pool
6/8

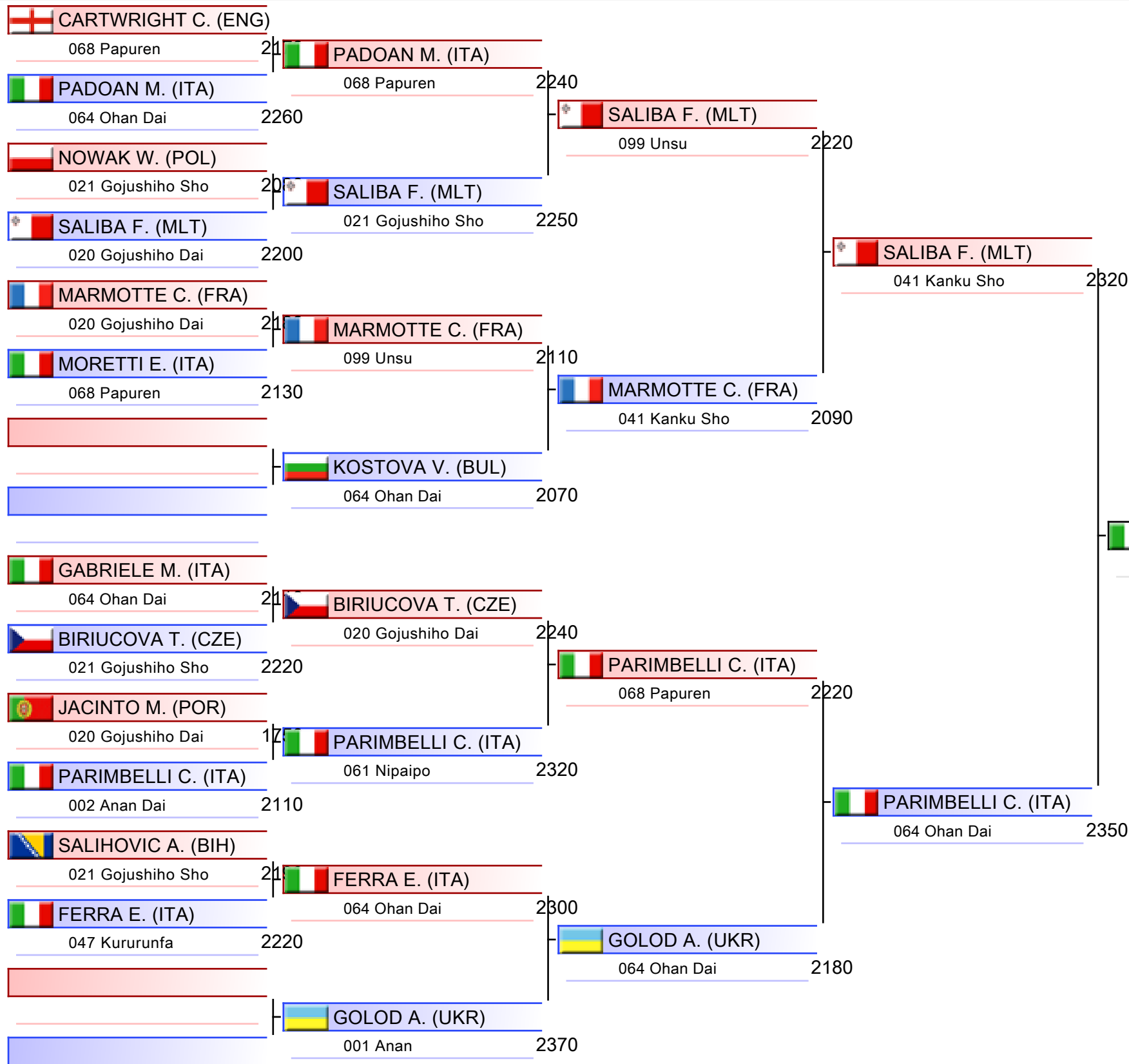

1. SHINJO RINZE (JPN)
2. ORDONEZ INES (FRA)
3. MARQUES RITA (POR)
3. RITZ LILA (SUI)
5. OLIVEIRA INÊS (POR)
5. MARCONI MARIA (ITA)
7. FIALKOVÁ SOFIA (SVK)
7. GRAZIA NICOL (ITA)

Junior Kata Female

Karate1 Youth League - Venice 2024, PALAZZO DEL TURISMO, Piazza Brescia 11, 30016 Lido di Jesolo VE, ITA

2024-12-05

Tatami
7 09:00

Pool
7/8

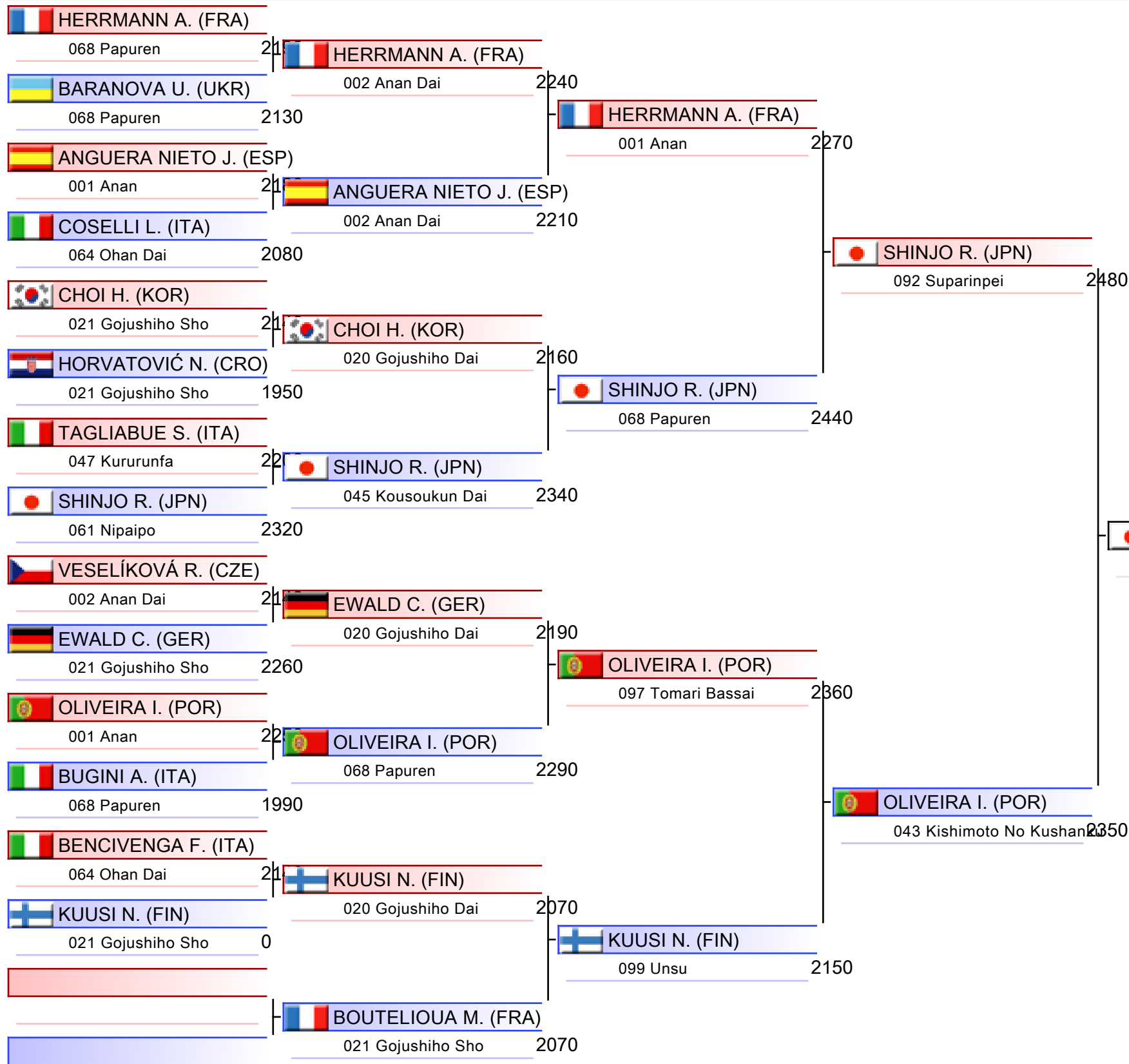

1. SHINJO RINZE (JPN)
2. ORDONEZ INES (FRA)
3. MARQUES RITA (POR)
3. RITZ LILA (SUI)
5. OLIVEIRA INÊS (POR)
5. MARCONI MARIA (ITA)
7. FIALKOVÁ SOFIA (SVK)
7. GRAZIA NICOL (ITA)

Junior Kata Female

Karate1 Youth League - Venice 2024, PALAZZO DEL TURISMO, Piazza Brescia 11, 30016 Lido di Jesolo VE, ITA

2024-12-05

Tatami
8 09:00

Pool
8/8

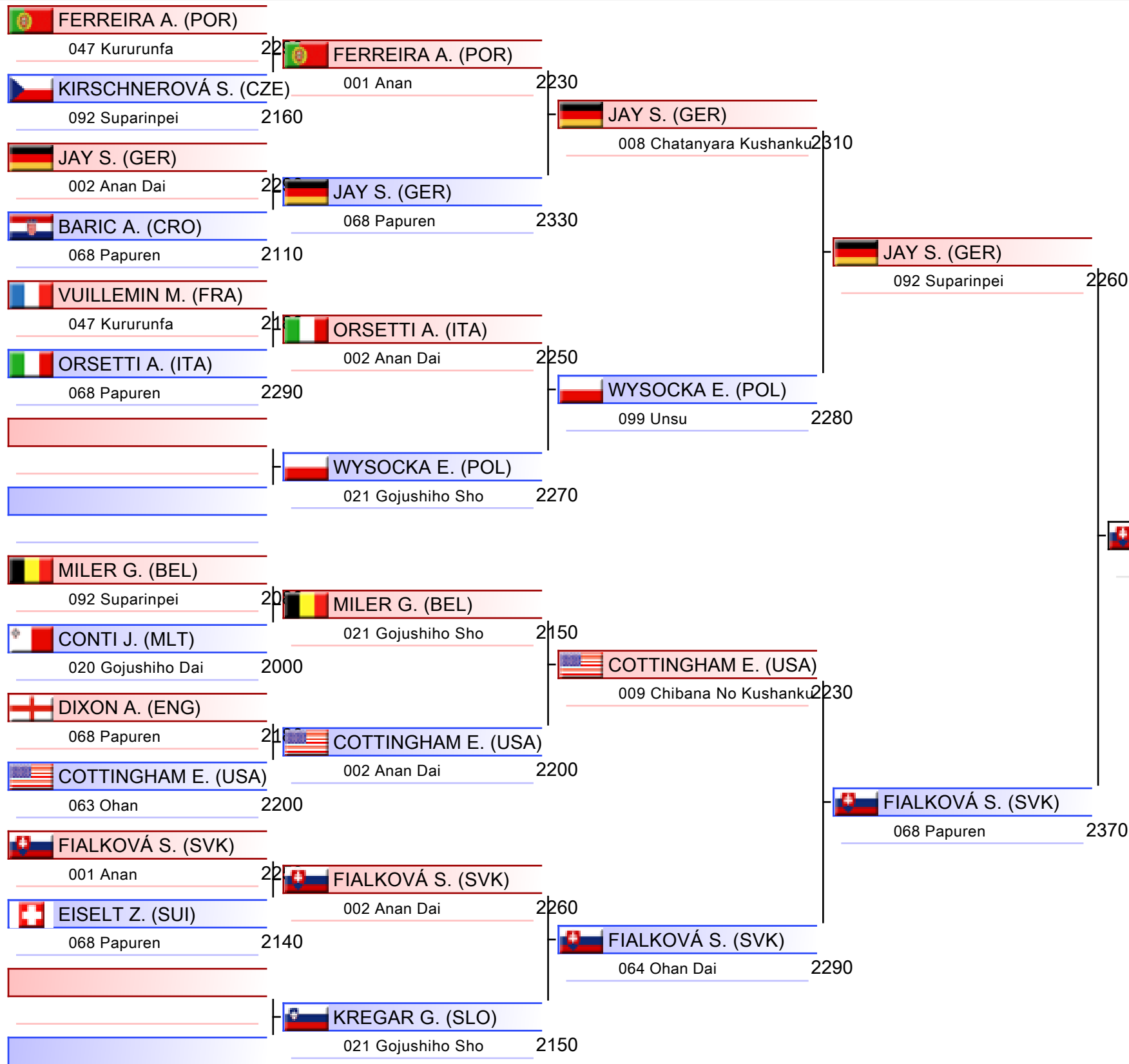

1. SHINJO RINZE (JPN)
2. ORDONEZ INES (FRA)
3. MARQUES RITA (POR)
3. RITZ LILA (SUI)
5. OLIVEIRA INÊS (POR)
5. MARCONI MARIA (ITA)
7. FIALKOVÁ SOFIA (SVK)
7. GRAZIA NICOL (ITA)

Pool winner-Junior Kata Female

Karate1 Youth League - Venice 2024, PALAZZO DEL TURISMO, Piazza Brescia 11, 30016 Lido di Jesolo VE, ITA

2024-12-05

Tatami

5 10:50

Pool

1/1

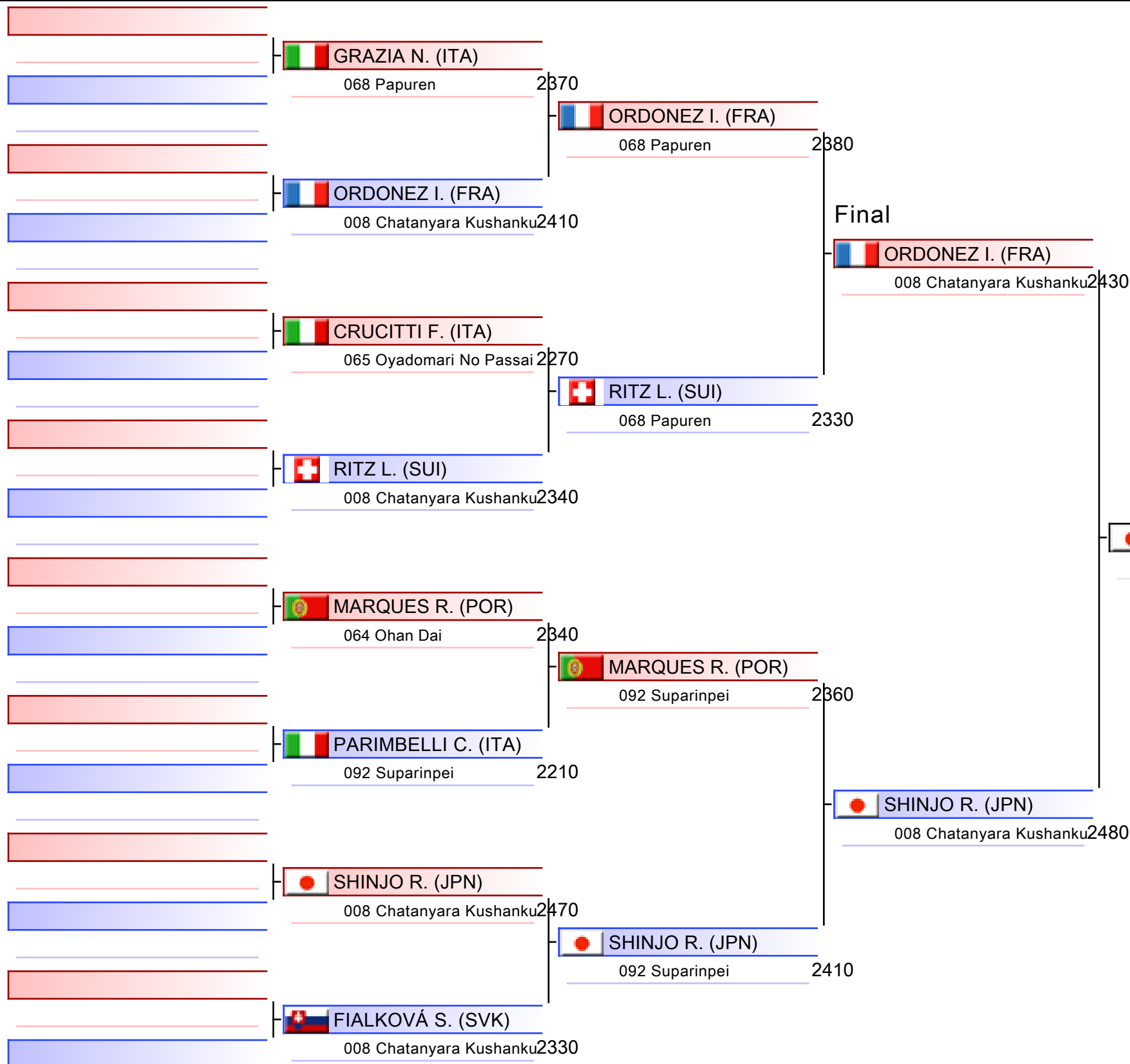

SHINJO R. (JPN)

1. SHINJO RINZE (JPN)
2. ORDONEZ INES (FRA)
3. MARQUES RITA (POR)
3. RITZ LILA (SUI)
5. OLIVEIRA INÊS (POR)
5. MARCONI MARIA (ITA)
7. FIALKOVÁ SOFIA (SVK)
7. GRAZIA NICOL (ITA)

Junior Kata Female

Karate1 Youth League - Venice 2024

2024-12-05

Tatami

3 13:00

Pool

1,2,3,4

(c)sportdata GmbH & Co KG 2000-2024 (2024-12-08 20:16) v 10.2.0 build 1 (2024-11-20 00:58 CET) License: SDIL TVG (expire 2025-01-26)

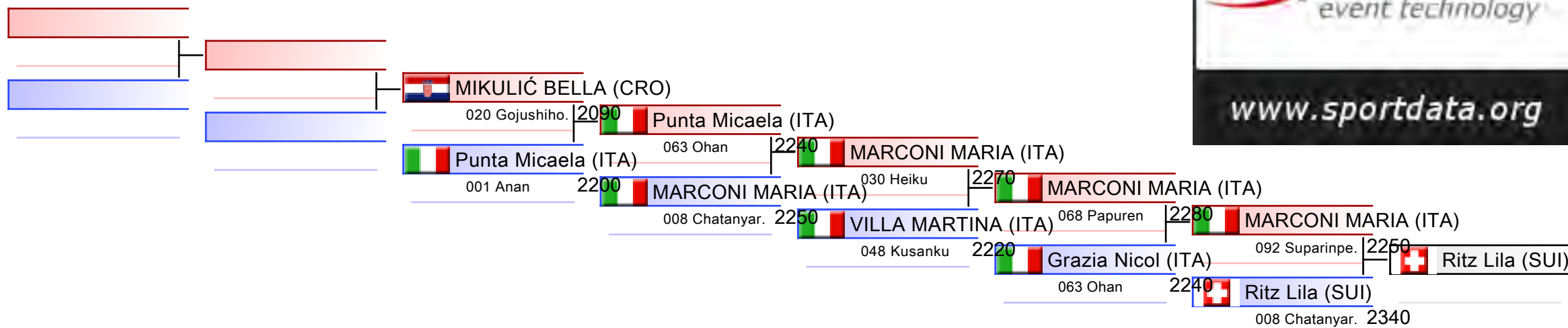

REPECHAGE: (1,2,3,4)

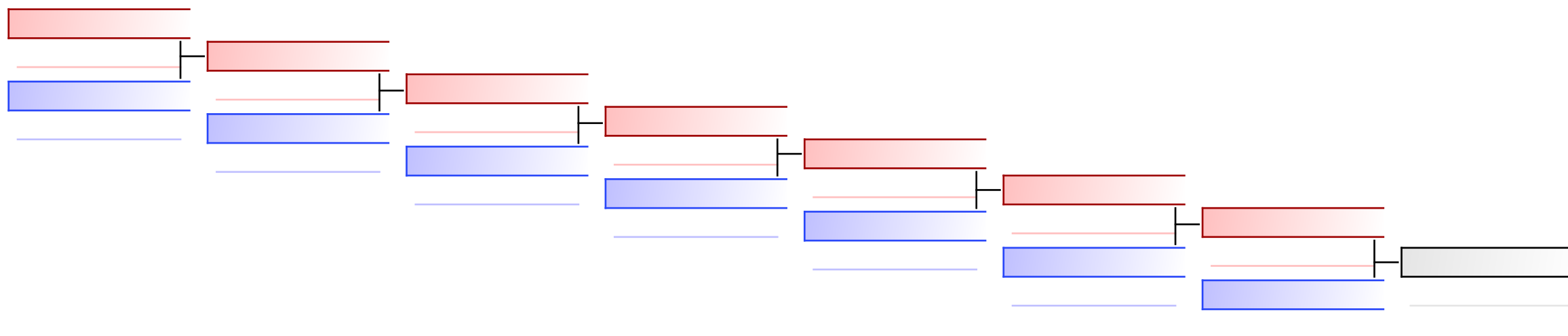

Junior Kata Female

Karate1 Youth League - Venice 2024

2024-12-05

Tatami

4 13:00

Pool

5,6,7,8

(c)sportdata GmbH & Co KG 2000-2024 (2024-12-08 20:16) v 10.2.0 build 1 (2024-11-20 00:58 CET) License: SDIL TVG (expire 2025-01-26)

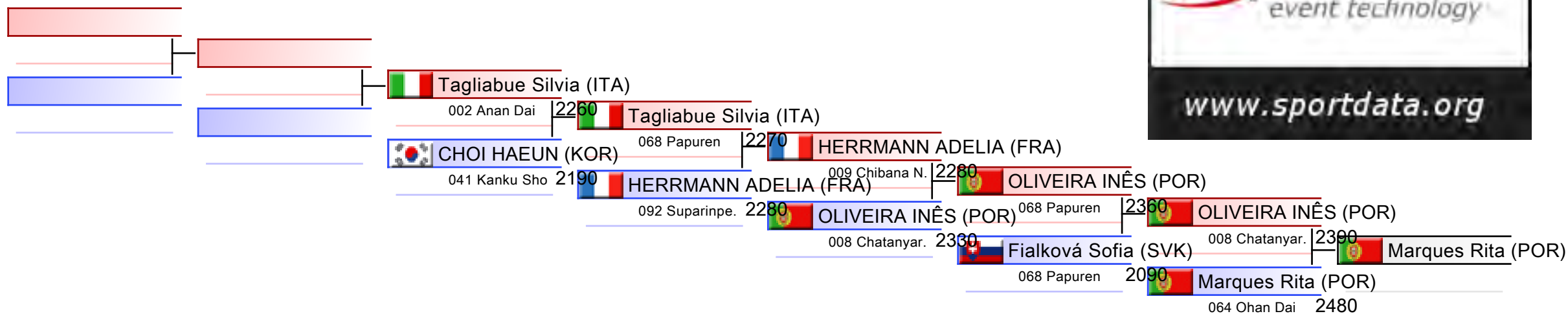

REPECHAGE: (5,6,7,8)

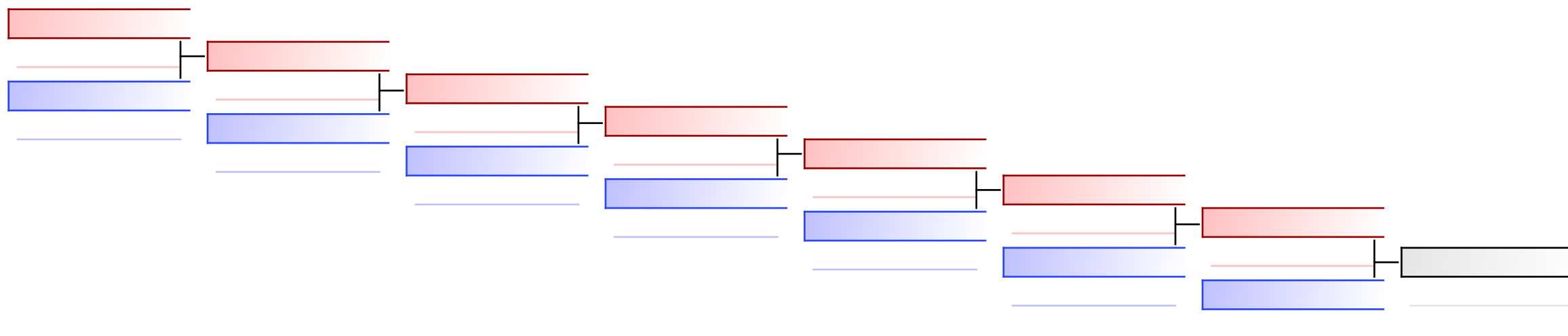



Karate1 Youth League - Venice 2024 - 2024-12-04



Official Results

Junior Kata Female (Entries: 116 Nations: 36)			
1	SHINJO RINZE		JPN - JAPAN
2	ORDONEZ INES		FRA - FRANCE
3	MARQUES RITA		POR - PORTUGAL
3	RITZ LILA		SUI - SWITZERLAND
5	OLIVEIRA INÉS		POR - PORTUGAL
5	MARCONI MARIA		ITA - ITALY
7	FIALKOVA SOFIA		SVK - SLOVAKIA
7	GRAZIA NICOL		ITA - ITALY
9	HERRMANN ADELIA		FRA - FRANCE
9	VILLA MARTINA		ITA - ITALY
11	TAGLIABUE SILVIA		ITA - ITALY
11	PUNTA MICAELA		ITA - ITALY
13	CHOI HAEUN		KOR - REPUBLIC OF KOREA
13	MIKULIC BELLA		CRO - CROATIA

JUNIOR KATA MALE



Karate1 Youth League - Venice 2024

ENTRIES BY WEIGHT CATEGORY



Junior Kata Male

As of 8 DEC 2024

Country Code	ID	Gender	Name	Seeding
AUT	AUT003120	M	Wagner Emil	
AUT	AUT02533	M	WU TIMON	
BUL	BUL02791	M	ANGOV ANGEL	
CAN	CAN02874	M	Gruitia Matthew B	
CRO		M	Erak Lovro	
CRO	CRO2641	M	FILES MARK	
CRO	CRO03384	M	Krsnik Vito	
CRO	CRO03014	M	Kukić Ivan	
CRO	CRO03085	M	Žeinski Ivan	
CZE	CZE02441	M	RAUSER ADAM	
CZE	CZE02259	M	ZLABEK JAKUB	
ENG		M	Dean Charlie	
ENG	ENG02826	M	Nastasa Robert	
ESP		M	CARMONA DIAZ ENRIQUE	
ESP		M	KARACH REVERTE USAMA	
ESP		M	Quinto Gomez Jesus	
ESP		M	Souto Iglesias Anton	
FRA	SD75768	M	Bordes Evan	
FRA		M	BRONDY Joackim	
FRA		M	Col Ahmet Yagiz	
FRA	SD57297	M	Courtois Tom	
FRA	SD79167	M	FLEITH Léo	
FRA	FRA04085	M	KLEMZ Thomas	
FRA	SD77484	M	MANFREDINI Hugo	
FRA		M	NGUYEN Toan	
FRA		M	Perini Camil	
FRA		M	RAMDANI MOHAMMED HAROUN	
GER	GER03127	M	ABU WAHIB JONAS	
GER	GER03274	M	BECKER SEBASTIAN	
GER		M	Glaevecke Damien	
GER		M	Gschwind Viktor	
GER		M	Koch Alexander	
GER	GER03128	M	LUECK ANDREW LYLE	
GER		M	Piechot Thomas	
HKG	HKG02513	M	CHIU WING HEI	
HKG	HKG02475	M	TSANG PAK YIN	
HUN	HUN02868	M	Gulyás Gergely	
HUN		M	László Samu	
ITA		M	aloise leonardo	
ITA		M	Artemciuc Denis	
ITA		M	BAGAROLO THOMAS	
ITA		M	Baroni Edoardo	
ITA	ITA04509	M	Bartolini Francesco	
ITA	ITA04498	M	Bicos Nikita	
ITA		M	BOTTINI Francesco	



Karate1 Youth League - Venice 2024

ENTRIES BY WEIGHT CATEGORY



Junior Kata Male

As of 8 DEC 2024

Country Code	ID	Gender	Name	Seeding
ITA		M	BRASILE ANTONIO	
ITA		M	Brundu Cristian	
ITA		M	Burali Davide	
ITA	ITA04491	M	CALABRESE FILIPPO	
ITA		M	Camanzo Salvatore	
ITA		M	CAPONERA Emanuele	
ITA		M	Carrozzino Luca	
ITA	ITA04235	M	Di Rubba Luigi	
ITA		M	Furlan Leonardo	
ITA	ITA04493	M	Moretti Oscar	
ITA	ITA04419	M	Ollagnero Giovanni	
ITA		M	Paraboschi Matteo	
ITA		M	Pilotto Nicolò	
ITA		M	PINTO ALESSIO	
ITA	SD52808	M	Putelli Nicolò	
ITA		M	Rapis Massimo	
ITA		M	Romagnoli Emanuel	
ITA	ITA005613	M	ROSSI FEDERICO	
ITA		M	SCIANNELLI GIULIO	
ITA		M	Speranza Alessio	
ITA	ITA04519	M	TRAUNINI SIMONE	
ITA		M	Zambotto Nicolò	
ITA		M	Zhou Marco	
JPN		M	Sato Yuya	
JPN		M	SHINJO YUKITO	
KOR	KOR002399	M	KIM MINJAE	
LUX		M	Arcq Alexander	
LUX	LUX02512	M	Bruscella Samuele Maria	
MDA	MDA002522	M	TERZI DAVID	
MNE		M	ALJOŠEVIĆ BENJAMIN	
NED		M	van der Heijden Luca	
POL	POL09154	M	SNIEGOCKI SZYMON	
POL	POL3064	M	WITTEK PATRYK	
POR		M	Barbosa Rodrigo	
POR		M	Moreira David	
POR	POR02948	M	Morgado Tomás	
POR		M	Oliveira Martim	
POR	POR02703	M	Santos Diogo	
POR	POR02704	M	Vieira João	
POR		M	Vilela Francisco	
SLO		M	AVDIBASIC DZENAN	
SLO	SLO02796	M	CICVARIC LUKA	
SRB	SD70852	M	Jakovljevic Vasilije	
SUI	SUI02603	M	Mischler Kevin	
SUI	SUI02743	M	Schedel Nolan	



Karate1 Youth League - Venice 2024

ENTRIES BY WEIGHT CATEGORY



Junior Kata Male

As of 8 DEC 2024

Country Code	ID	Gender	Name	Seeding
SVK	SVK02797	M	Gyulaffy Peter	
SVK		M	Hudec Adam	
SVK		M	Muller Juraj	
SVK	SD55903	M	Nedoroscik Daniel	
SVK		M	Otrubčák Samuel	
SWE		M	Leinsköld William	
SWE		M	Pettersson Ilias	
SWE	SWE02904	M	SKOTTESTAD ISAK	
TUR	TUR2945	M	çalışkan eyüp can	
TUR	TUR3045	M	KOÇ TARIK	
UKR		M	Bilous Ivan	
UKR		M	Duchenko Tymur	
UKR	SD48959	M	Hlushchenko Artur	
UKR	UKR03069	M	Khablo Danylo	
UKR		M	Nevozhai Maksym	
USA	USA02982	M	Isa Cheon	
VEN	VEN02631	M	GRECO GIANLUCA	

Junior Kata Male

Karate1 Youth League - Venice 2024, PALAZZO DEL TURISMO, Piazza Brescia 11, 30016 Lido di Jesolo VE, ITA

2024-12-05

Tatami

1 11:05

Pool

1/8

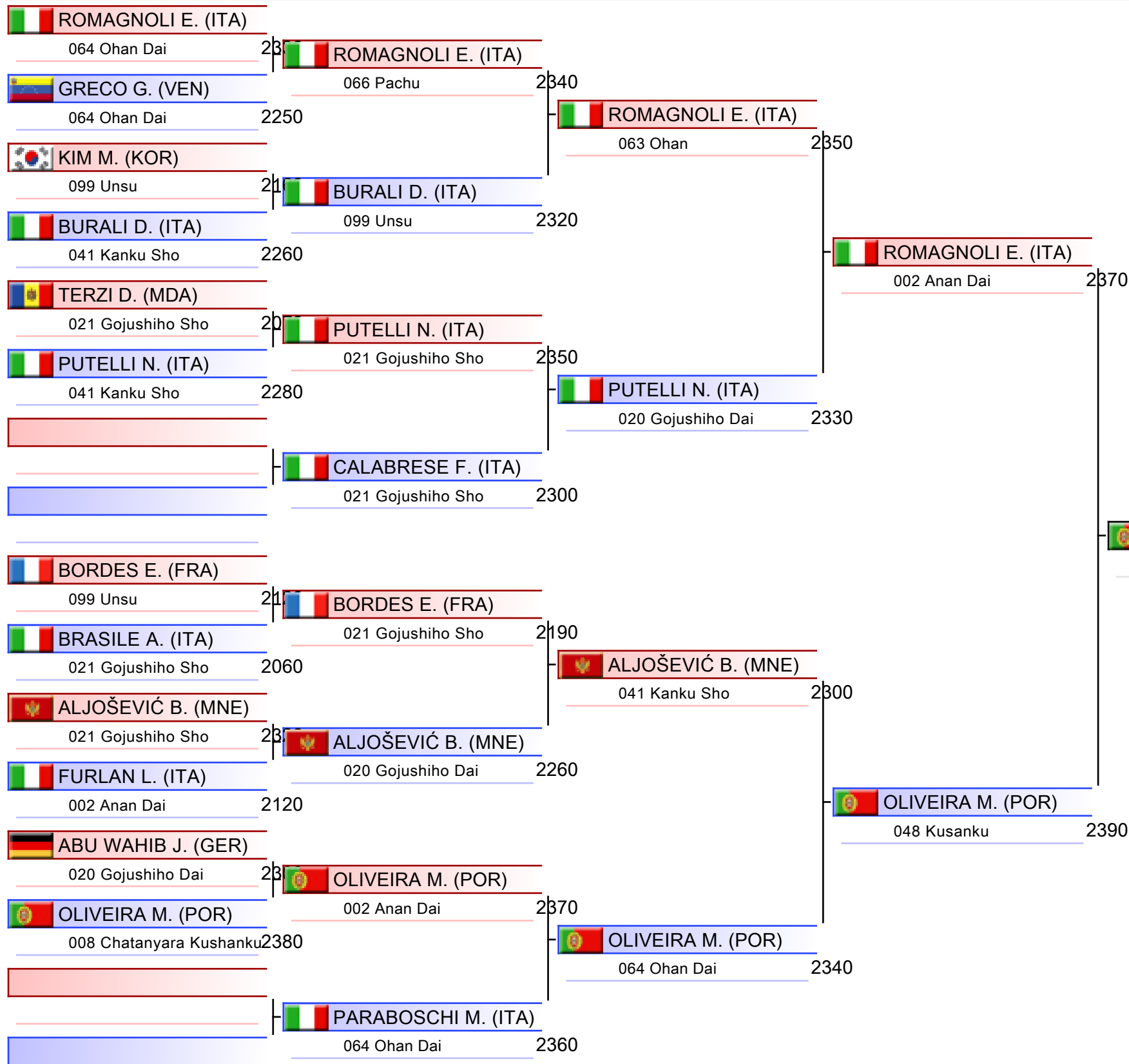

1. CAPONERA EMANUELE (ITA)
2. OLIVEIRA MARTIM (POR)
3. DI RUBBA LUIGI (ITA)
3. VIEIRA JOÃO (POR)
5. TSANG PAK YIN (HKG)
5. KLEMZ THOMAS (FRA)
7. ABU WAHIB JONAS (GER)
7. JAKOVLJEVIC VASILJE (SRB)

Junior Kata Male

Karate1 Youth League - Venice 2024, PALAZZO DEL TURISMO, Piazza Brescia 11, 30016 Lido di Jesolo VE, ITA

2024-12-05

Tatami
2 11:05

Pool
2/8

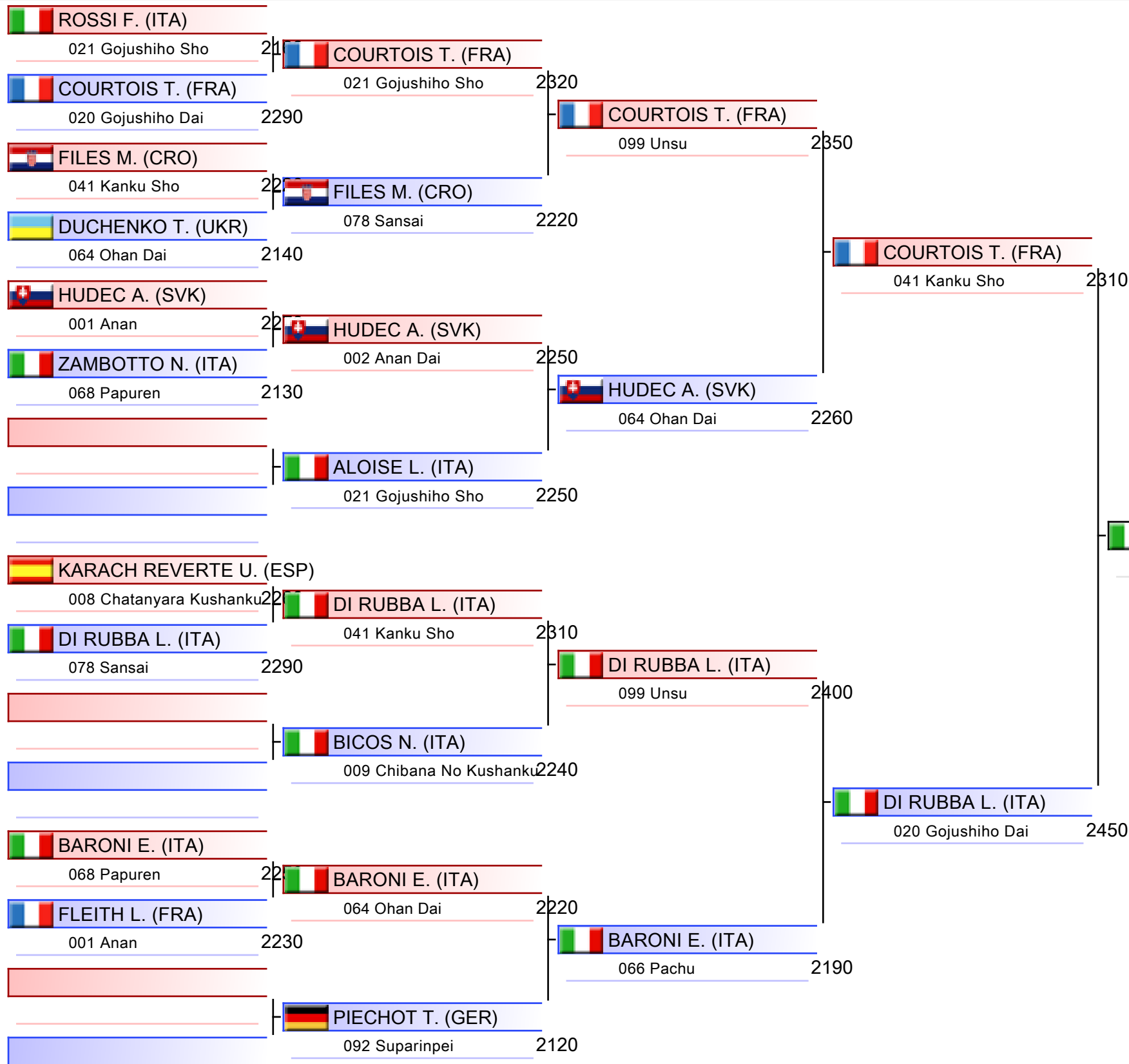

1. CAPONERA EMANUELE (ITA)
2. OLIVEIRA MARTIM (POR)
3. DI RUBBA LUIGI (ITA)
3. VIEIRA JOÃO (POR)
5. TSANG PAK YIN (HKG)
5. KLEMZ THOMAS (FRA)
7. ABU WAHIB JONAS (GER)
7. JAKOVLJEVIC VASILJE (SRB)

Junior Kata Male

Karate1 Youth League - Venice 2024, PALAZZO DEL TURISMO, Piazza Brescia 11, 30016 Lido di Jesolo VE, ITA

2024-12-05

Tatami
3 11:05

Pool
3/8

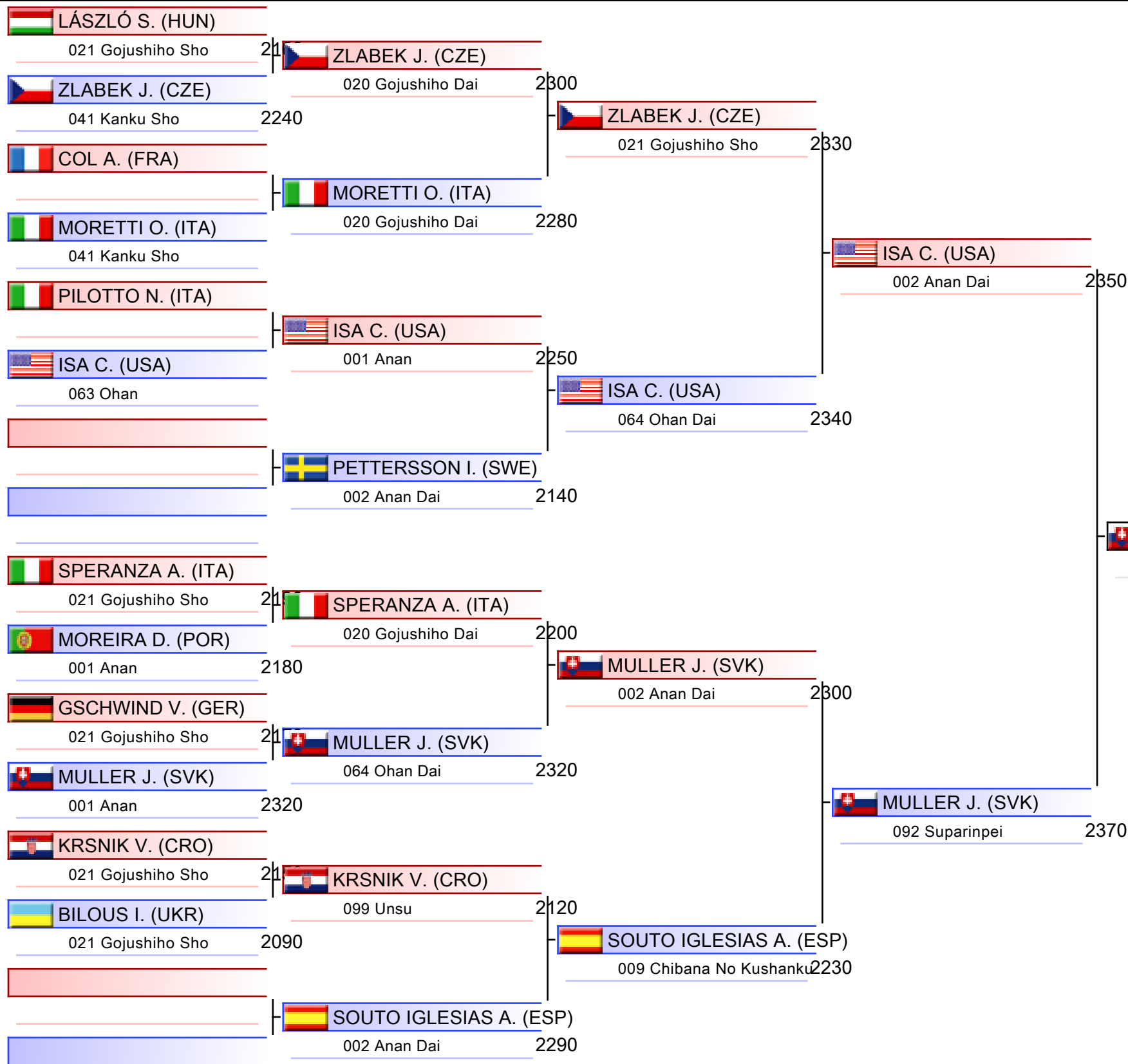

1. CAPONERA EMANUELE (ITA)
2. OLIVEIRA MARTIM (POR)
3. DI RUBBA LUIGI (ITA)
3. VIEIRA JOÃO (POR)
5. TSANG PAK YIN (HKG)
5. KLEMZ THOMAS (FRA)
7. ABU WAHIB JONAS (GER)
7. JAKOVLJEVIC VASILJE (SRB)

Junior Kata Male

Karate1 Youth League - Venice 2024, PALAZZO DEL TURISMO, Piazza Brescia 11, 30016 Lido di Jesolo VE, ITA

2024-12-05

Tatami
4 11:05

Pool
4/8

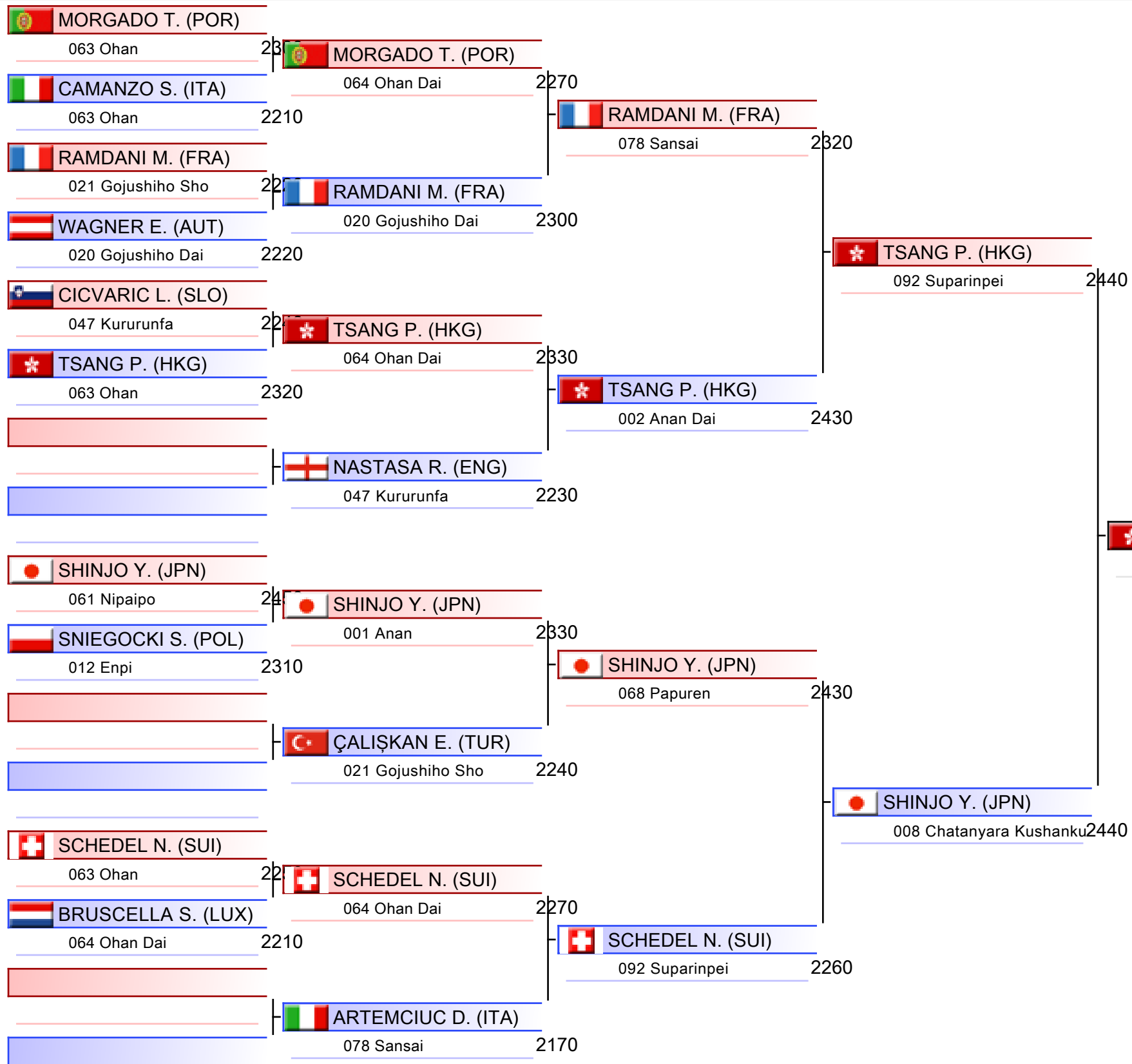

1. CAPONERA EMANUELE (ITA)
2. OLIVEIRA MARTIM (POR)
3. DI RUBBA LUIGI (ITA)
3. VIEIRA JOÃO (POR)
5. TSANG PAK YIN (HKG)
5. KLEMZ THOMAS (FRA)
7. ABU WAHIB JONAS (GER)
7. JAKOVLJEVIC VASILJE (SRB)

Junior Kata Male

Karate1 Youth League - Venice 2024, PALAZZO DEL TURISMO, Piazza Brescia 11, 30016 Lido di Jesolo VE, ITA

2024-12-05

Tatami
5 11:05

Pool
5/8

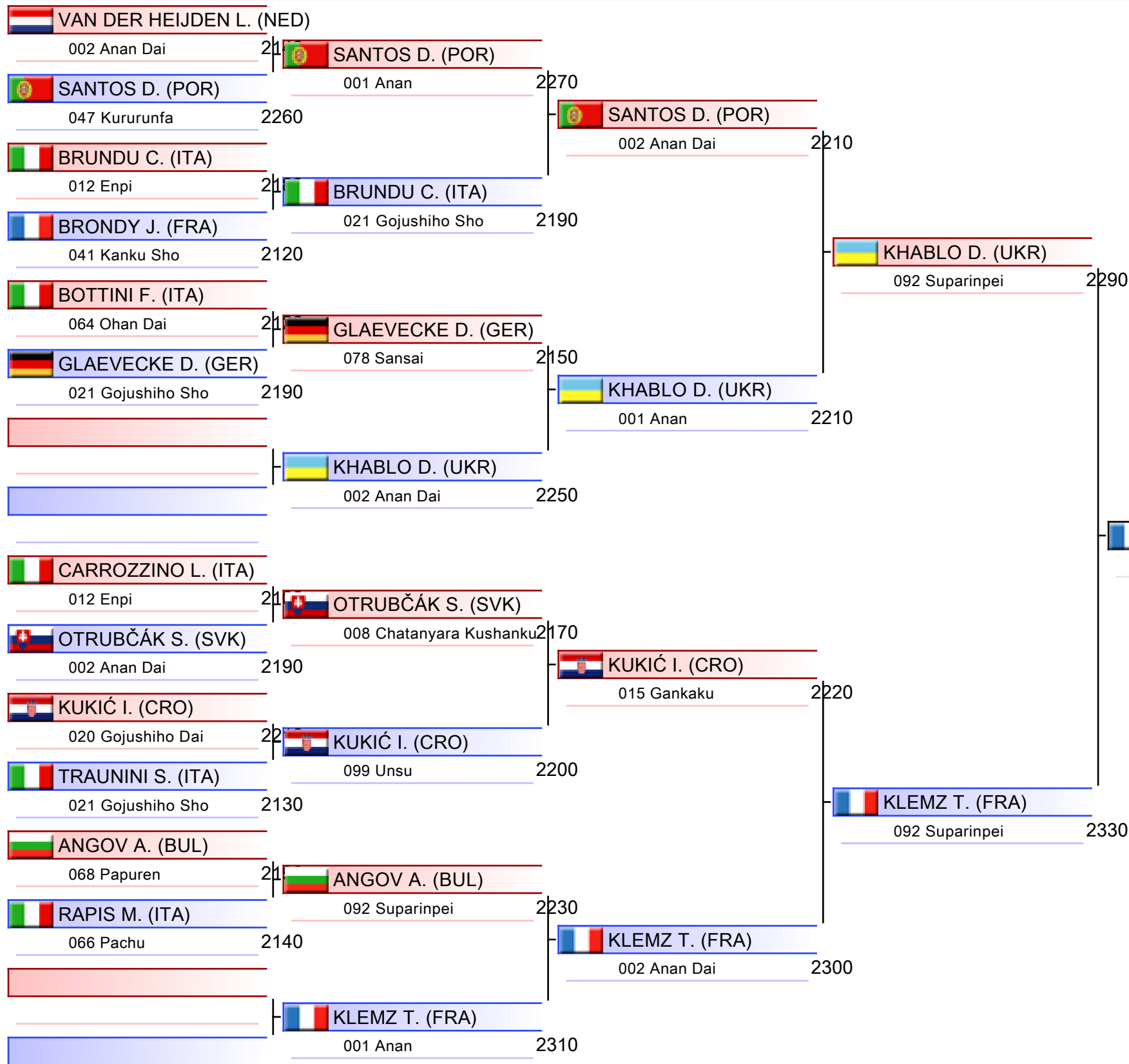

1. CAPONERA EMANUELE (ITA)
2. OLIVEIRA MARTIM (POR)
3. DI RUBBA LUIGI (ITA)
3. VIEIRA JOÃO (POR)
5. TSANG PAK YIN (HKG)
5. KLEMZ THOMAS (FRA)
7. ABU WAHIB JONAS (GER)
7. JAKOVLJEVIC VASILJE (SRB)

Junior Kata Male

Karate1 Youth League - Venice 2024, PALAZZO DEL TURISMO, Piazza Brescia 11, 30016 Lido di Jesolo VE, ITA

2024-12-05

Tatami
6 11:05

Pool
6/8

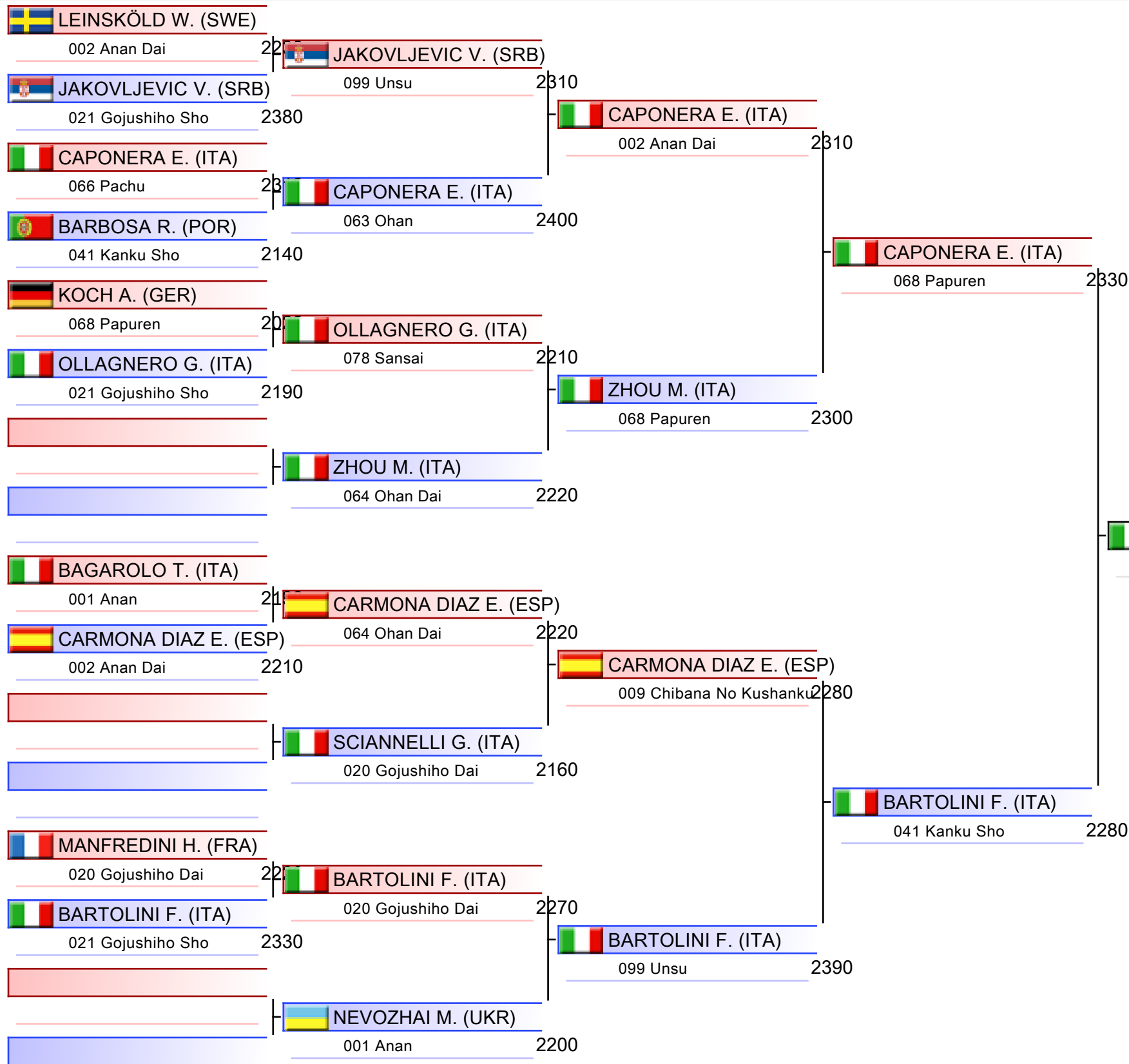

1. CAPONERA EMANUELE (ITA)
2. OLIVEIRA MARTIM (POR)
3. DI RUBBA LUIGI (ITA)
3. VIEIRA JOÃO (POR)
5. TSANG PAK YIN (HKG)
5. KLEMZ THOMAS (FRA)
7. ABU WAHIB JONAS (GER)
7. JAKOVLJEVIC VASILJE (SRB)

Junior Kata Male

Karate1 Youth League - Venice 2024, PALAZZO DEL TURISMO, Piazza Brescia 11, 30016 Lido di Jesolo VE, ITA

2024-12-05

Tatami

7 11:05

Pool

7/8

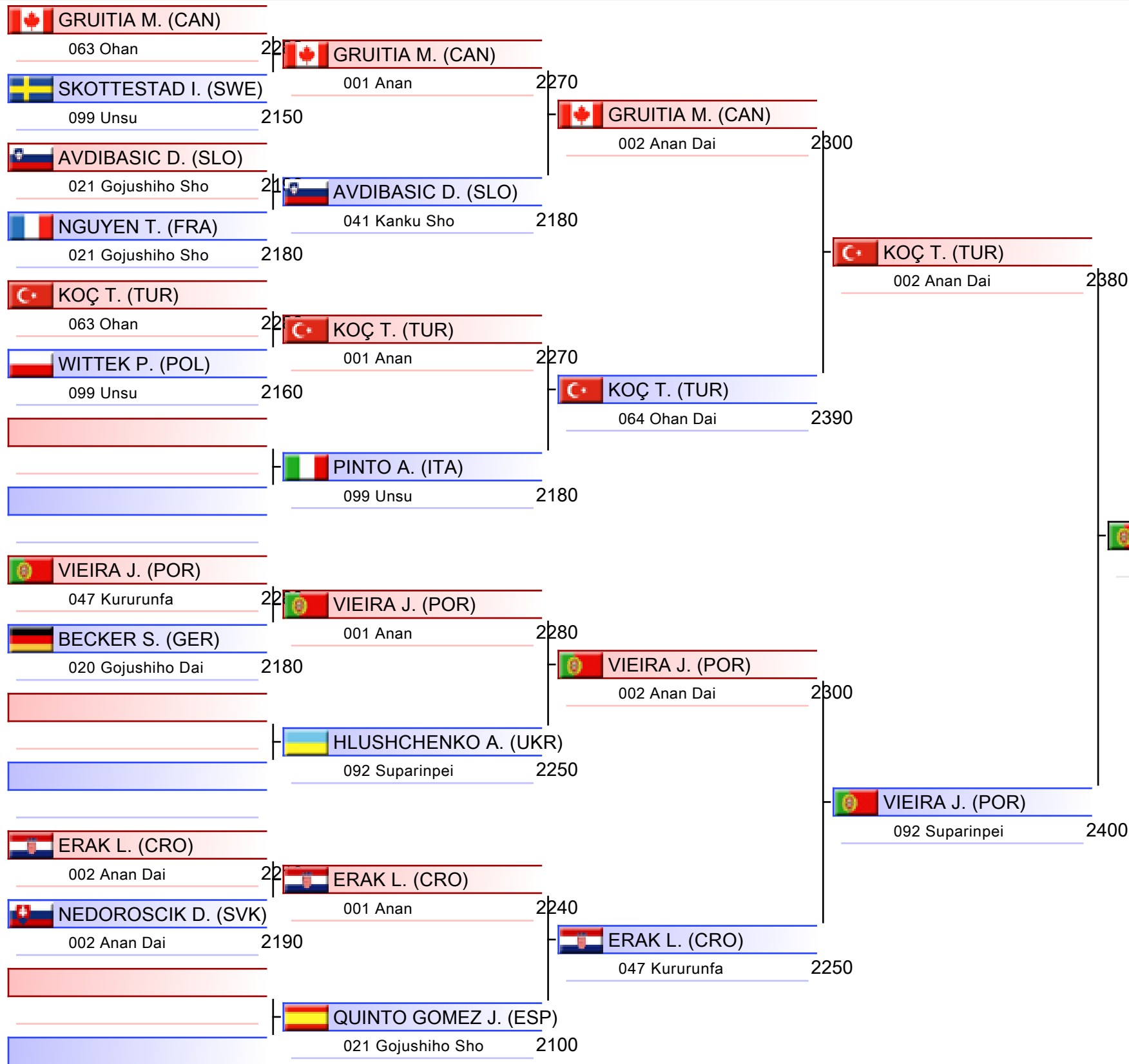

1. CAPONERA EMANUELE (ITA)
2. OLIVEIRA MARTIM (POR)
3. DI RUBBA LUIGI (ITA)
3. VIEIRA JOÃO (POR)
5. TSANG PAK YIN (HKG)
5. KLEMZ THOMAS (FRA)
7. ABU WAHIB JONAS (GER)
7. JAKOVLJEVIC VASILJE (SRB)

Junior Kata Male

Karate1 Youth League - Venice 2024, PALAZZO DEL TURISMO, Piazza Brescia 11, 30016 Lido di Jesolo VE, ITA

2024-12-05

Tatami
8 11:05

Pool
8/8

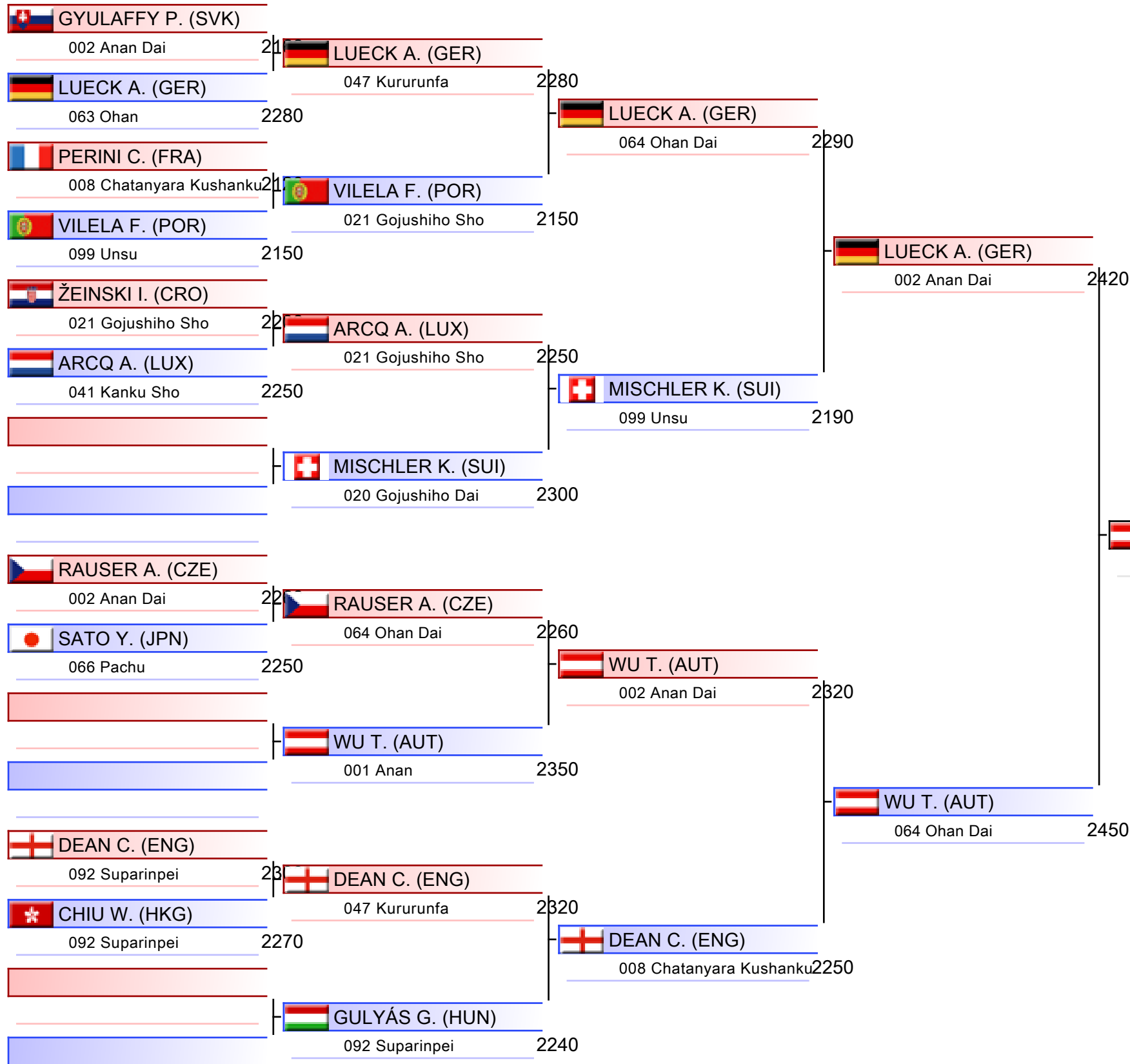

1. CAPONERA EMANUELE (ITA)
2. OLIVEIRA MARTIM (POR)
3. DI RUBBA LUIGI (ITA)
3. VIEIRA JOÃO (POR)
5. TSANG PAK YIN (HKG)
5. KLEMZ THOMAS (FRA)
7. ABU WAHIB JONAS (GER)
7. JAKOVLJEVIC VASILJE (SRB)

Pool winner-Junior Kata Male

Karate1 Youth League - Venice 2024, PALAZZO DEL TURISMO, Piazza Brescia 11, 30016 Lido di Jesolo VE, ITA

2024-12-05

Tatami
1 12:35

Pool
1/1

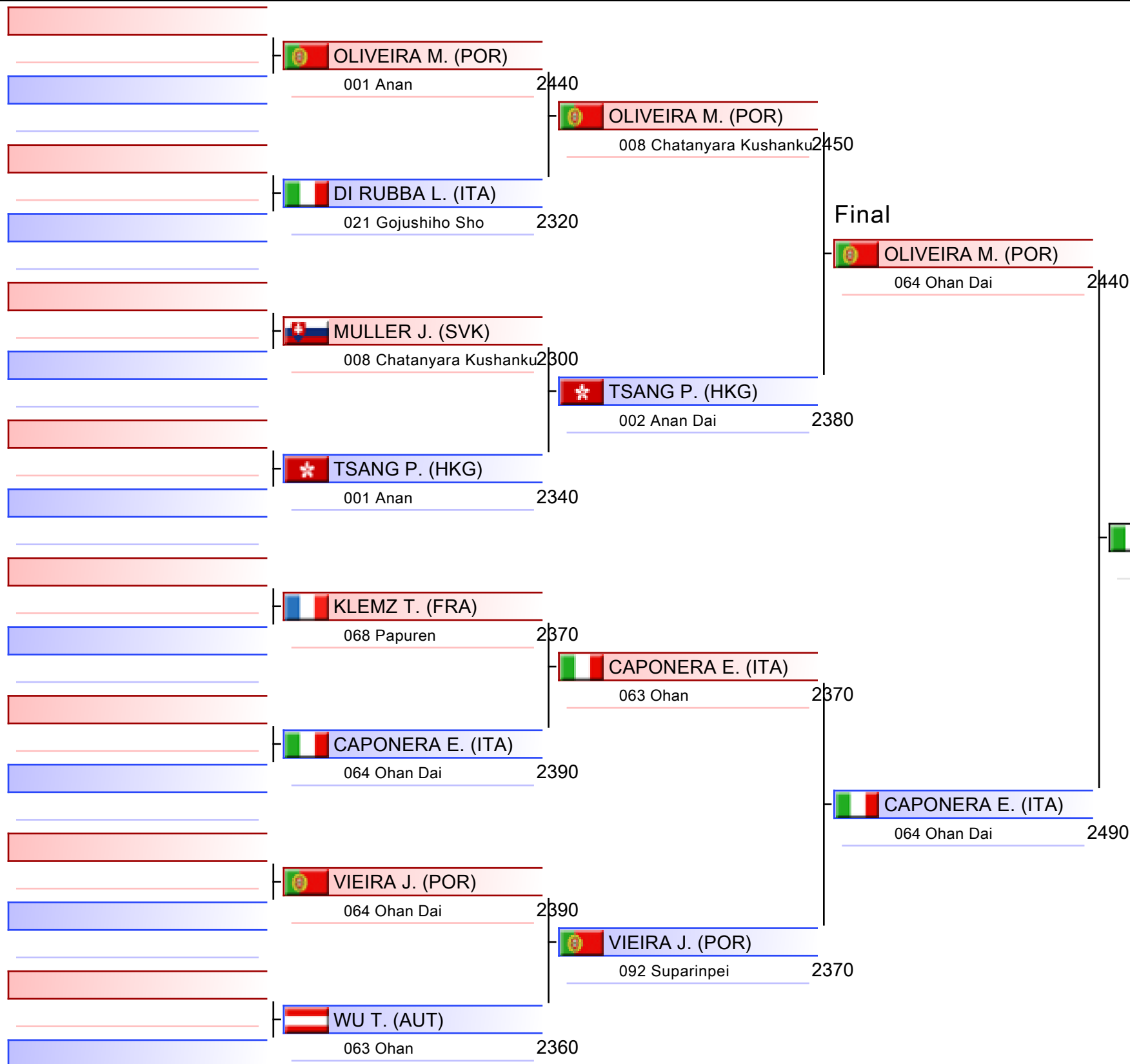

1. CAPONERA EMANUELE (ITA)
2. OLIVEIRA MARTIM (POR)
3. DI RUBBA LUIGI (ITA)
3. VIEIRA JOÃO (POR)
5. TSANG PAK YIN (HKG)
5. KLEMZ THOMAS (FRA)
7. ABU WAHIB JONAS (GER)
7. JAKOVLJEVIC VASILJE (SRB)

Junior Kata Male

Karate1 Youth League - Venice 2024

2024-12-05

Tatami

1 13:00

Pool

4,1,2,3

(c)sportdata GmbH & Co KG 2000-2024 (2024-12-08 20:16) v 10.2.0 build 1 (2024-11-20 00:58 CET) License: SDIL TVG (expire 2025-01-26)

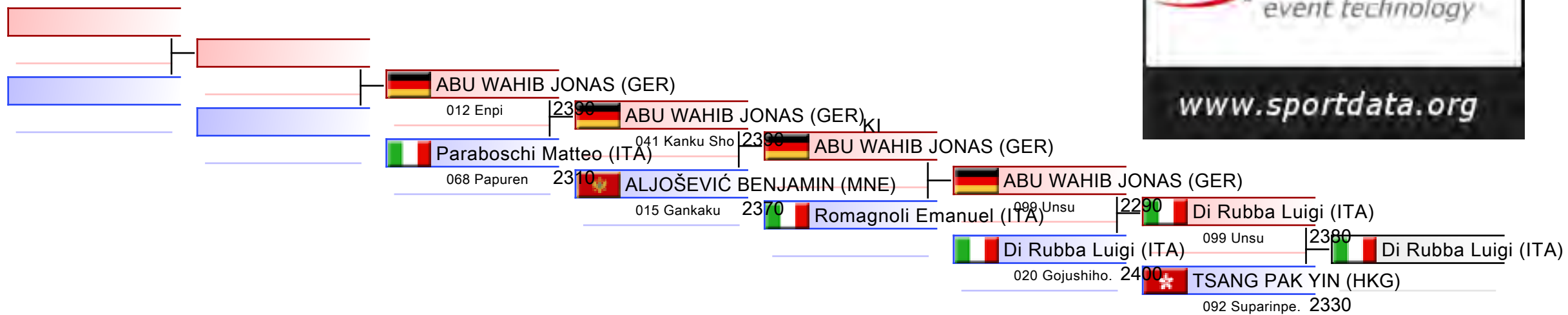

REPECHAGE: (4,1,2,3)

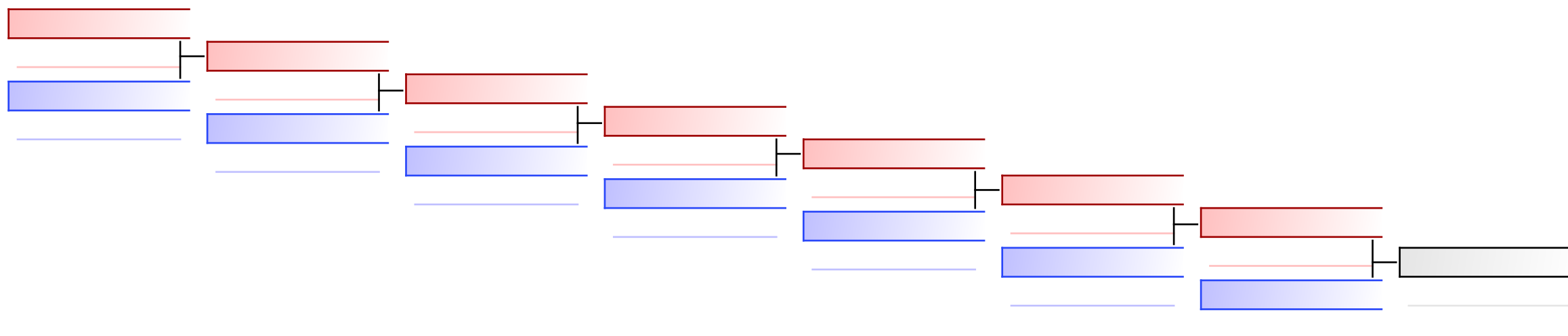

Junior Kata Male

Karate1 Youth League - Venice 2024

2024-12-05

Tatami

2 13:00

Pool

5,6,7,8

(c)sportdata GmbH & Co KG 2000-2024 (2024-12-08 20:16) v 10.2.0 build 1 (2024-11-20 00:58 CET) License: SDIL TVG (expire 2025-01-26)

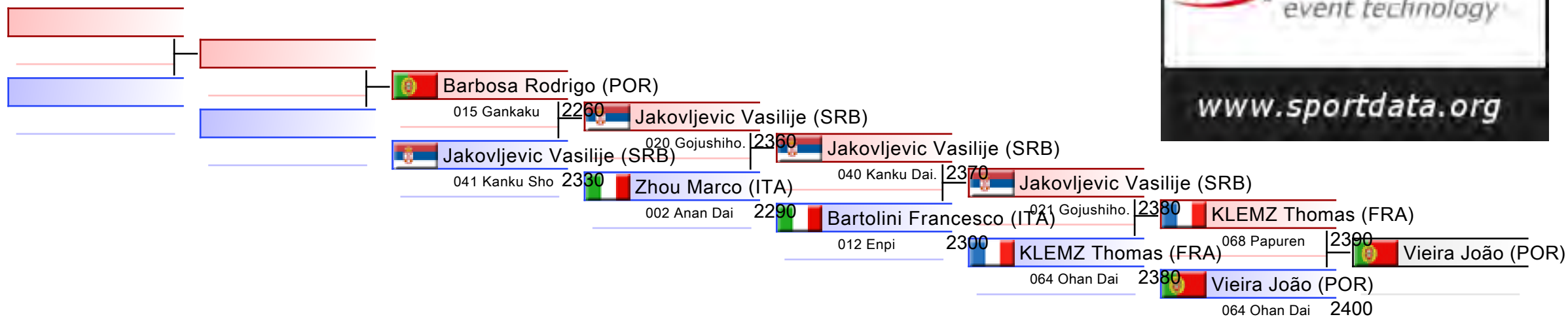

REPECHAGE: (5,6,7,8)

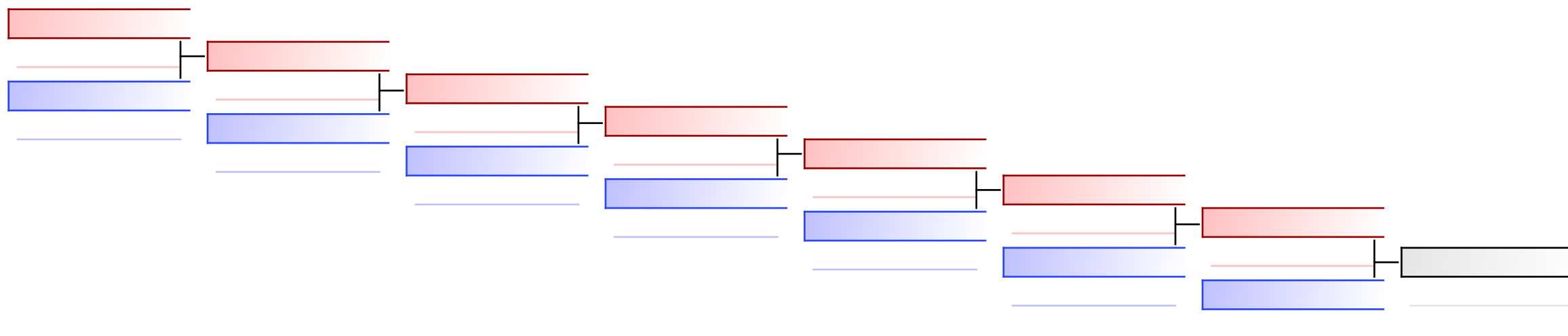



Karate1 Youth League - Venice 2024 - 2024-12-04



Official Results

Junior Kata Male (Entries: 107 Nations: 29)			
1	CAPONERA EMANUELE		ITA - ITALY
2	OLIVEIRA MARTIM		POR - PORTUGAL
3	DI RUBBA LUIGI		ITA - ITALY
3	VIEIRA JOÃO		POR - PORTUGAL
5	TSANG PAK YIN		HKG - HONG KONG, CHINA
5	KLEMZ THOMAS		FRA - FRANCE
7	ABU WAHIB JONAS		GER - GERMANY
7	JAKOVLJEVIC VASILIJE		SRB - SERBIA
9	ROMAGNOLI EMANUEL		ITA - ITALY
9	BARTOLINI FRANCESCO		ITA - ITALY
11	ALJOŠEVIĆ BENJAMIN		MNE - MONTENEGRO
11	ZHOU MARCO		ITA - ITALY
13	PARABOSCHI MATTEO		ITA - ITALY
13	BARBOSA RODRIGO		POR - PORTUGAL

JUNIOR KUMITE FEMALE -48 KG



Karate1 Youth League - Venice 2024

ENTRIES BY WEIGHT CATEGORY



Junior Kumite Female -48 kg

As of 8 DEC 2024

Country Code	ID	Gender	Name	Seeding
ALB	ALB2138	F	BACKA XHEJDAH	
AND	AND02227	F	GONZALEZ GOMEZ PAULA	
BEL	BEL02896	F	YUKSEKTEPE ASYA	
BIH		F	Hodzic Emina	
BIH		F	Zukić Adna	
BIH		F	Zukić Nejra	
CAN		F	Delarosa Kiara	
CRO		F	Čamber Ivana	
CRO	CRO03733	F	JUKIC EMA	
CRO		F	Stojaković Dorotea	
CRO	CRO2817	F	TRSTENJAK AIDA	
CYP	CYP02829	F	EFSTATHIOU CONSTANTINA	
CZE		F	Mladkova Anezka	
DEN		F	Bath Sofia	
ENG	ENG011720	F	Anthony Kyla May	
ENG	ENG02821	F	Giurma-Handley Adela	
ESP		F	MARTI MARCO SARA	
ESP	ESP03478	F	MATOS PERAL LOLA	
FRA		F	bourouba maissa	
FRA	FRA03436	F	Cochard Lola	
FRA		F	Kerneur Hermione	
GER		F	Bradel Stella	
GER		F	Brettnacher Mia	
GER	GER03301	F	Drehmann Emily-Chiara	
GRE	GRE02642	F	Pappa Christina Triada	
GRE	GRE02897	F	SYKA AGNI	
HUN		F	Deák Sára	
ITA		F	Abenante Laura	
ITA	SD71020	F	Bossi Alessandra	
ITA		F	Calcagno Alice	
ITA		F	calin alexia viorica	
ITA		F	CAPATTI GIADA	
ITA	ITA04692	F	Caselli Elisa Laetitia	
ITA		F	CATONA SILVIA	
ITA	ITA04255	F	DE FALCO ASIA	
ITA		F	GROSSI ALESSANDRA	
ITA		F	LEGITTIMO LUDOVICA	
ITA		F	Lucci Miriam	
ITA		F	MURGIA ALESSIA	
ITA	ITA04516	F	uniti noemi	
ITA		F	Vietri Rebecca	
LAT	SD67216	F	Konajeva Jevgenija	
LTU		F	Petrauskaite Gerda	
LUX		F	Moens Alix	
NED		F	Mezraui Dounia Sofia	



Karate1 Youth League - Venice 2024

ENTRIES BY WEIGHT CATEGORY



Junior Kumite Female -48 kg
As of 8 DEC 2024

Country Code	ID	Gender	Name	Seeding
POL	POL10818	F	SAWICKA ADELA	
POL	POL3143	F	WASILEWSKA ZUZANNA	
POR		F	Santos Diana	
ROU	ROU03737	F	BAICU LORENA	
SLO	SLO02889	F	KUTNJAK URSKA	
SRB		F	Djordjevic Andjela	
SRB	SRB03019	F	Miranovic Masa	
SVK	SD32292	F	Bytčanek Stella	
SVK	SVK02589	F	Jalowiczorova Veronika	
SVK		F	Mierna Adriana	
SVK	SD77108	F	Verebová Sára	
SWE	SWE 03084	F	Engdahl Leilani	
SWE	SWE02686	F	NYMAN AGNES	
TUR	TUR03719	F	YILDIRIM Defne Eda	
UKR		F	Hudym Veronika	
VEN		F	GÓMEZ DUGARTE ARIANNA MAIBETH	
VEN		F	Loyo Montero Katherine	
VEN		F	TORO KATHERINE	

Junior Kumite Female -48 kg

Karate1 Youth League - Venice 2024, PALAZZO DEL TURISMO, Piazza Brescia 11, 30016 Lido di Jesolo VE, ITA

2024-12-05

Tatami
5 16:20

Pool
1/4

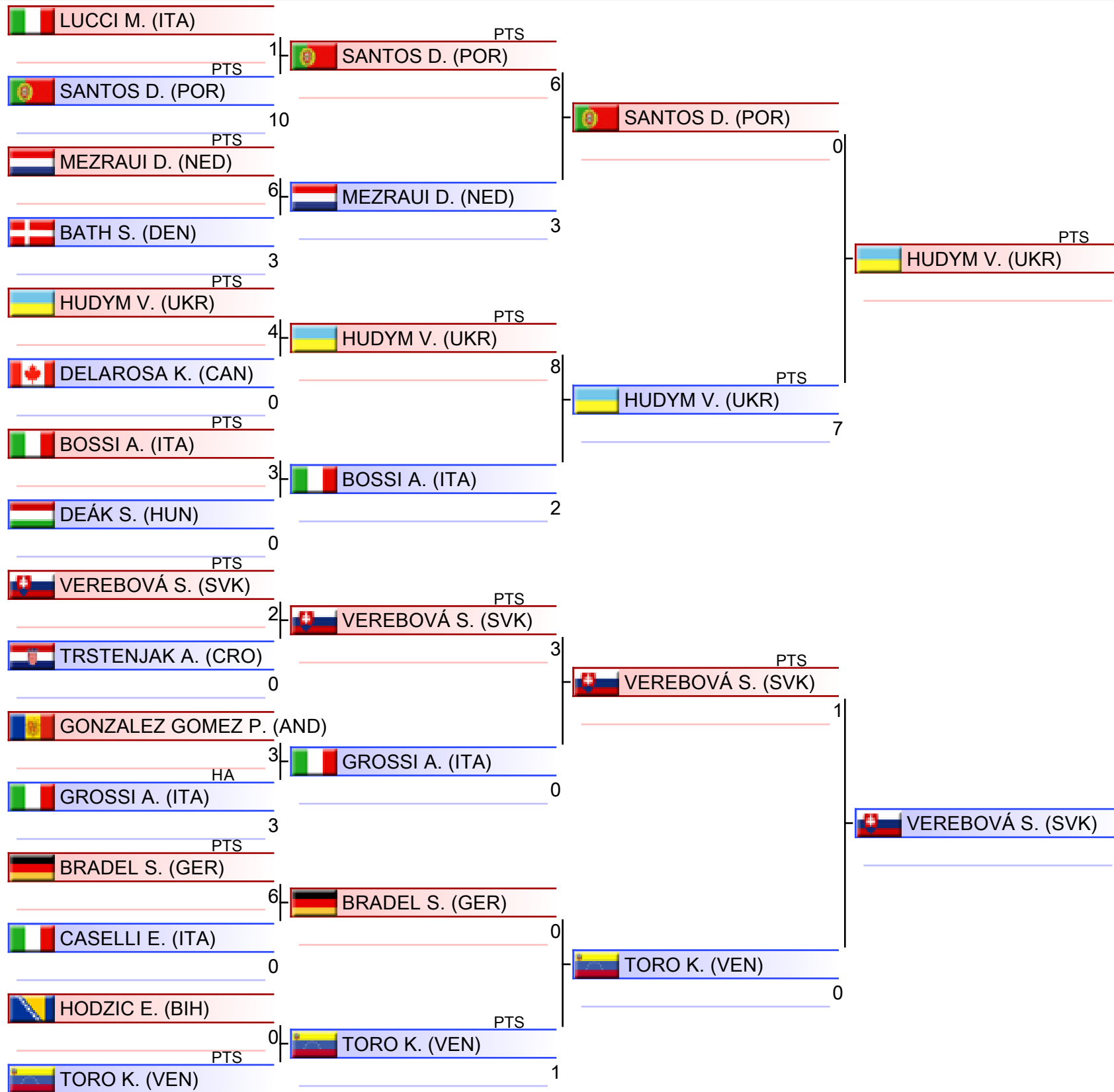

1. NYMAN AGNES (SWE)
2. HUDYM VERONIKA (UKR)
3. DE FALCO ASIA (ITA)
3. LEGITTIMO LUDOVICA (ITA)
5. SANTOS DIANA (POR)
5. MURGIA ALESSIA (ITA)
7. VEREBOVÁ SÁRA (SVK)
7. MIRANOVIC MASA (SRB)

Junior Kumite Female -48 kg

Karate1 Youth League - Venice 2024, PALAZZO DEL TURISMO, Piazza Brescia 11, 30016 Lido di Jesolo VE, ITA

2024-12-05

Tatami
6 16:20

Pool
2/4

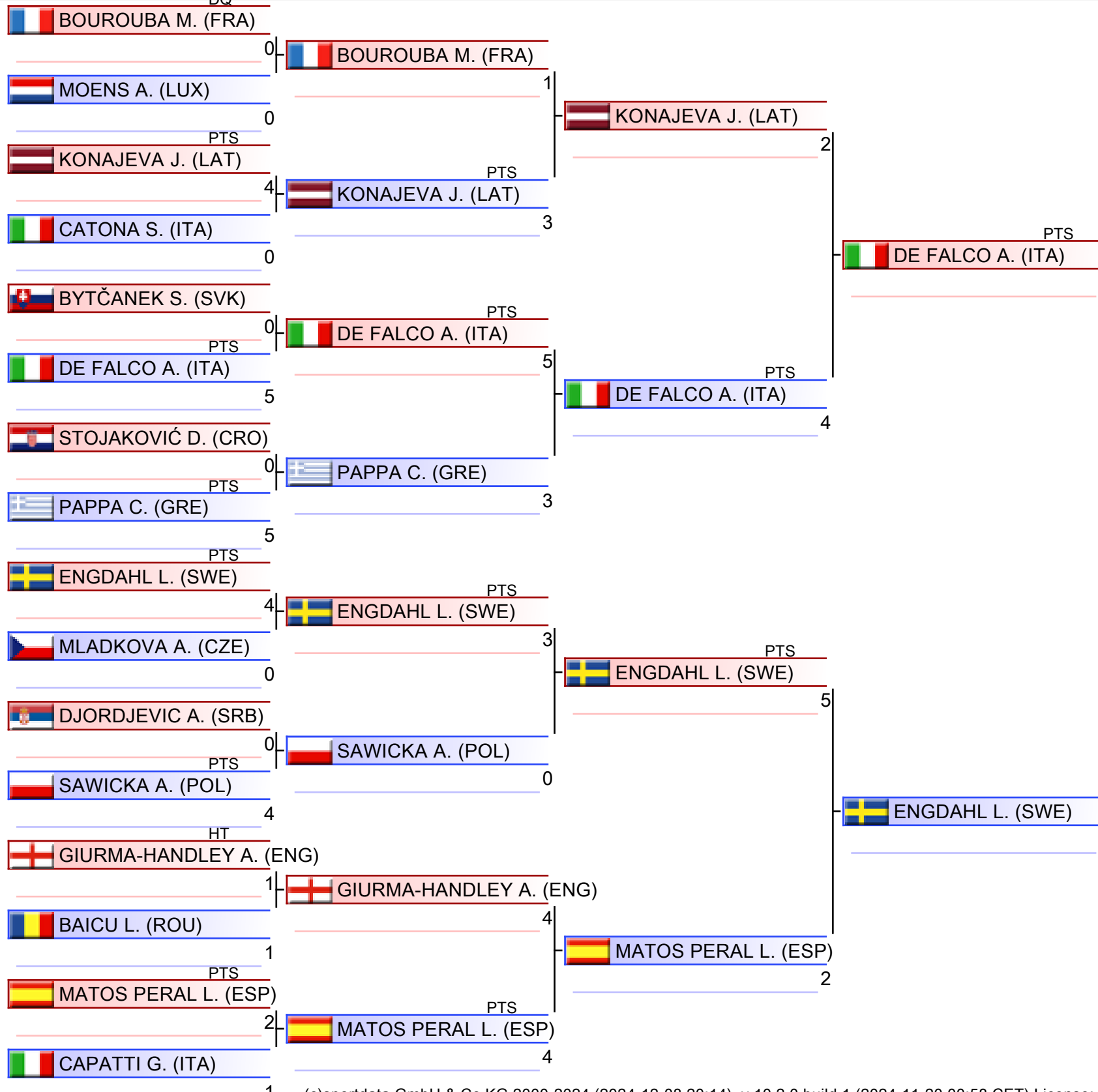

1. NYMAN AGNES (SWE)
2. HUDYM VERONIKA (UKR)
3. DE FALCO ASIA (ITA)
3. LEGITTIMO LUDOVICA (ITA)
5. SANTOS DIANA (POR)
5. MURGIA ALESSIA (ITA)
7. VEREBOVÁ SÁRA (SVK)
7. MIRANOVIC MASA (SRB)

Junior Kumite Female -48 kg

Karate1 Youth League - Venice 2024, PALAZZO DEL TURISMO, Piazza Brescia 11, 30016 Lido di Jesolo VE, ITA

2024-12-05

Tatami

7 16:20

Pool

3/4

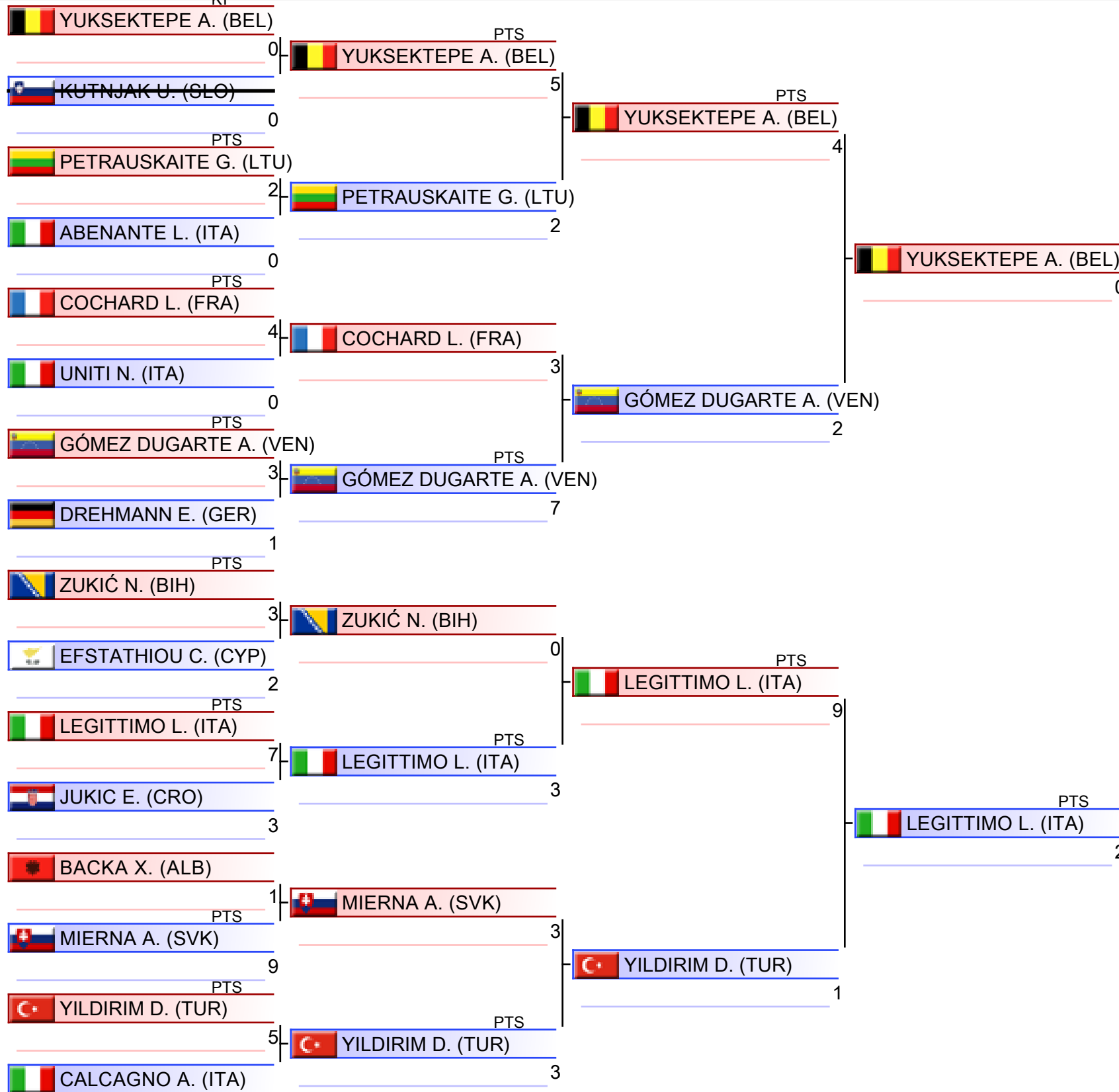

1. NYMAN AGNES (SWE)
2. HUDYM VERONIKA (UKR)
3. DE FALCO ASIA (ITA)
3. LEGITTIMO LUDOVICA (ITA)
5. SANTOS DIANA (POR)
5. MURGIA ALESSIA (ITA)
7. VEREBOVÁ SÁRA (SVK)
7. MIRANOVIC MASA (SRB)

Junior Kumite Female -48 kg

Karate1 Youth League - Venice 2024, PALAZZO DEL TURISMO, Piazza Brescia 11, 30016 Lido di Jesolo VE, ITA

2024-12-05

Tatami

8 16:20

Pool

4/4

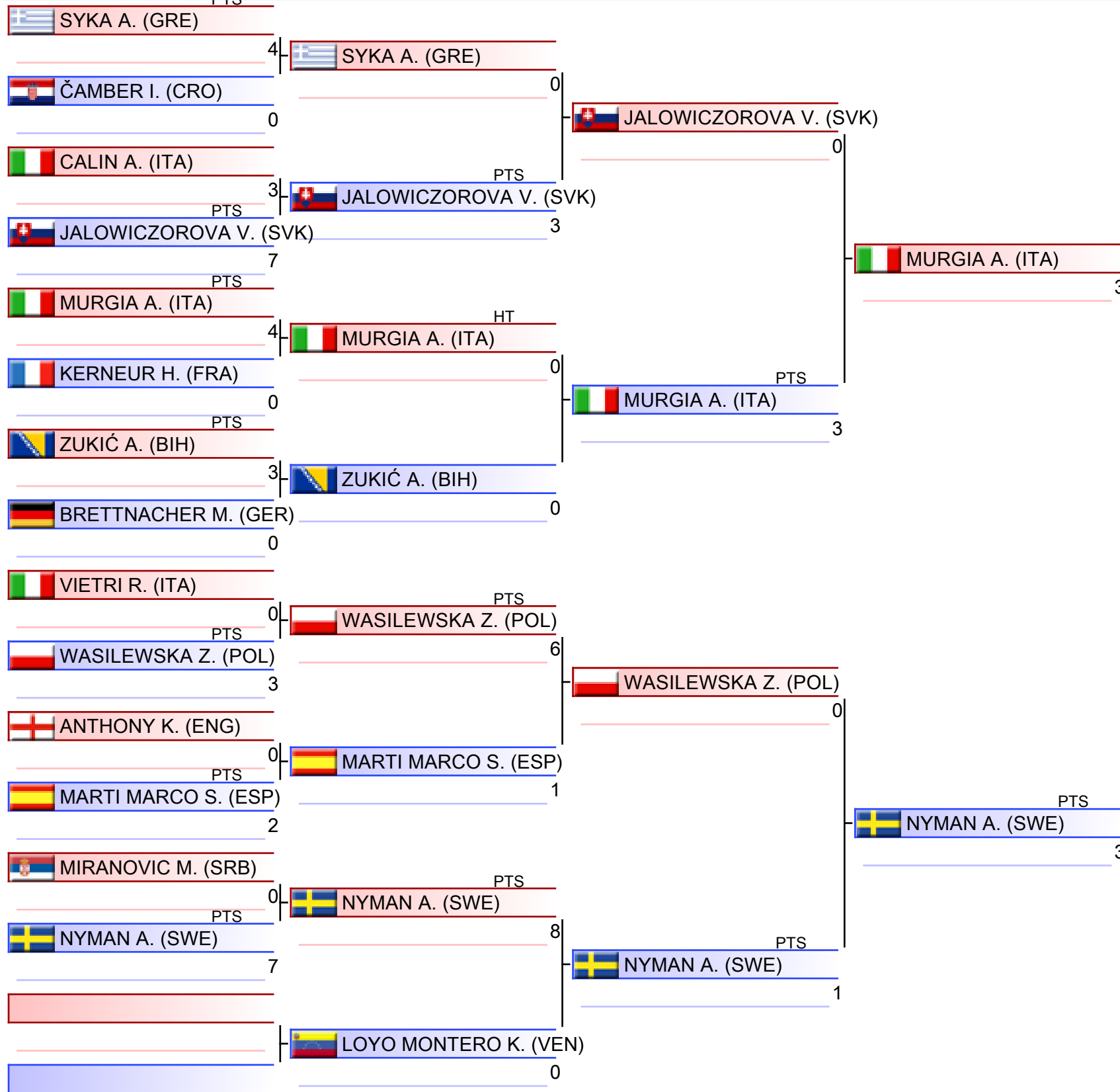

1. NYMAN AGNES (SWE)
2. HUDYM VERONIKA (UKR)
3. DE FALCO ASIA (ITA)
3. LEGITTIMO LUDOVICA (ITA)
5. SANTOS DIANA (POR)
5. MURGIA ALESSIA (ITA)
7. VEREBOVÁ SÁRA (SVK)
7. MIRANOVIC MASA (SRB)

Pool winner-Junior Kumite Female -48 kg

Karate1 Youth League - Venice 2024, PALAZZO DEL TURISMO, Piazza Brescia 11, 30016 Lido di Jesolo VE, ITA

2024-12-05

Tatami
5 17:45

Pool
1/1

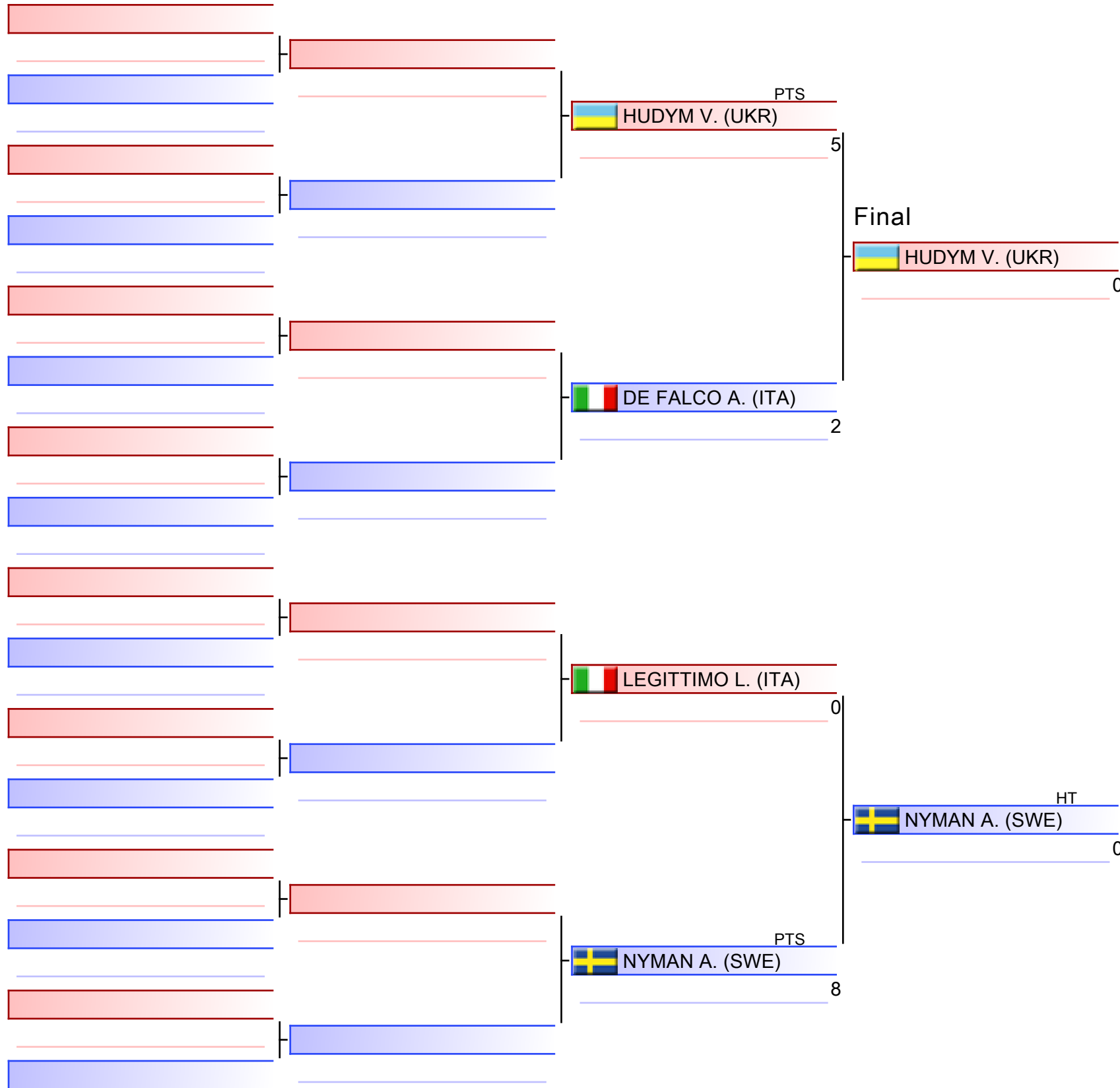

NYMAN A. (SWE)

1. NYMAN AGNES (SWE)
2. HUDYM VERONIKA (UKR)
3. DE FALCO ASIA (ITA)
3. LEGITTIMO LUDOVICA (ITA)
5. SANTOS DIANA (POR)
5. MURGIA ALESSIA (ITA)
7. VEREBOVÁ SÁRA (SVK)
7. MIRANOVIC MASA (SRB)

Junior Kumite Female -48 kg

Karate1 Youth League - Venice 2024

2024-12-05

Tatami

7 19:10

Pool

1,2,3,4

(c)sportdata GmbH & Co KG 2000-2024 (2024-12-08 20:16) v 10.2.0 build 1 (2024-11-20 00:58 CET) License: SDIL TVG (expire 2025-01-26)

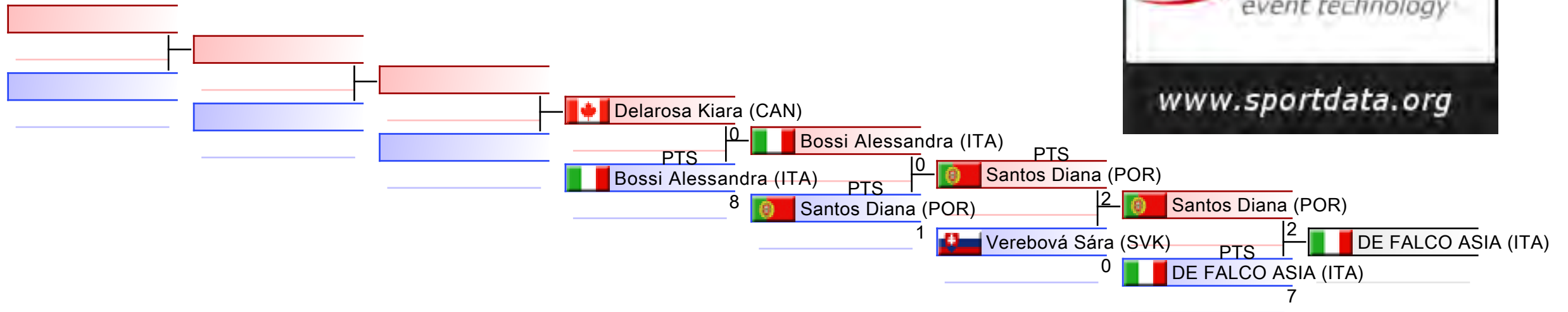

REPECHAGE: (1,2,3,4)

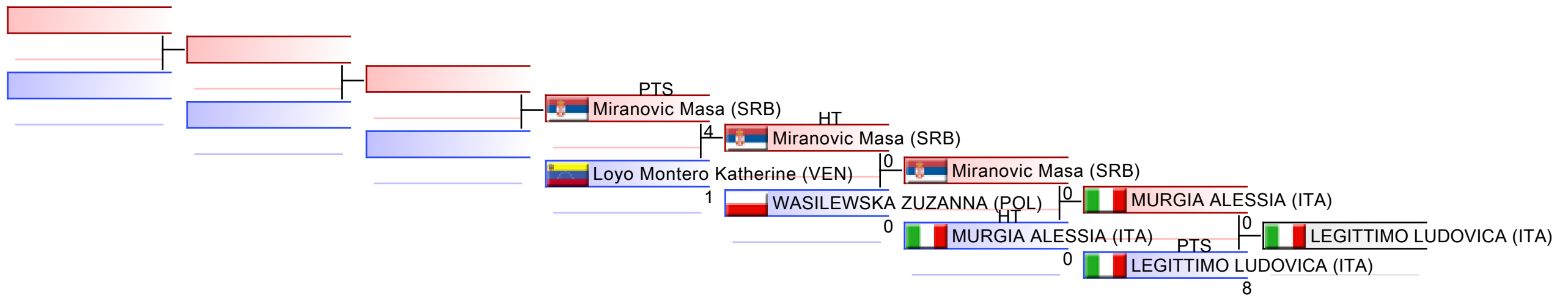



Karate1 Youth League - Venice 2024 - 2024-12-04



Official Results

Junior Kumite Female -48 kg (Entries: 63 Nations: 30)			
1	NYMAN AGNES		SWE - SWEDEN
2	HUDYM VERONIKA		UKR - UKRAINE
3	DE FALCO ASIA		ITA - ITALY
3	LEGITTIMO LUDOVICA		ITA - ITALY
5	SANTOS DIANA		POR - PORTUGAL
5	MURGIA ALESSIA		ITA - ITALY
7	VEREBOVÁ SÁRA		SVK - SLOVAKIA
7	MIRANOVIC MASA		SRB - SERBIA
9	BOSSI ALESSANDRA		ITA - ITALY
9	WASILEWSKA ZUZANNA		POL - POLAND
11	DELAROSA KIARA		CAN - CANADA
11	LOYO MONTERO KATHERINE		VEN - VENEZUELA

JUNIOR KUMITE FEMALE -53 KG



Karate1 Youth League - Venice 2024

ENTRIES BY WEIGHT CATEGORY



Junior Kumite Female -53 kg
As of 8 DEC 2024

Country Code	ID	Gender	Name	Seeding
AIN-1		F	GASHNIKOVA VERONIKA	
BIH		F	BEŠIĆ EMA	
BIH		F	Marjanovic Kristina	
BIH		F	Meskovic Ajla	
BIH		F	Rastoder Hena	
BIH		F	Softić Lamija	
CRO	CRO03380	F	Kordić Matea	
CYP		F	Michailidou Philippa	
CZE	CZE02434	F	MALA DANIELA	
CZE	CZE02258	F	NOVAKOVA KATERINA	
ENG	ENG011725	F	Anthony Shanae Theresa	
ESP	ESP03036	F	Apellániz Oihane	
ESP		F	FEO CABO ANDREA	
ESP		F	VIZCAINO CALVO RUTH	
FRA		F	Grenon Jade	
FRA		F	Hasbrouck Eva	
FRA		F	Ruiz Oriane	
FRA	FRA03631	F	SCHMITT ELSA	
GER		F	Henze Hannah	
GER		F	Schmitz Celine	
GER	GER03116	F	Siemon Nora	
GER	GER03135	F	WOLF ALEXANDRA	
GRE	GRE03623	F	PARASKEVOPOULOU MARINA	
GRE		F	TZANI ZOI	
HKG	HKG02511	F	WONG HAN YI HIDY	
HUN		F	Bárdos Anna	
HUN		F	Dalnoki Szófia	
ITA	ITA04689	F	Boncori Sofia	
ITA		F	Capone Bianca	
ITA		F	CHIAPPARELLI GIADA	
ITA		F	chimisso maria	
ITA		F	Condemi Gaia	
ITA		F	CRAIU BIATRIS IONELA	
ITA		F	Curto Martina	
ITA	SD71232	F	De Simone Letizia	
ITA	ITA04276	F	D Angelo Ludovica Luigia	
ITA		F	LANDI ALESSIA	
ITA		F	LEONI ADELE	
ITA		F	LORENZON MATILDE	
ITA		F	LUCENTE LETIZIA	
ITA		F	LUCIANI SIRIA	
ITA		F	MARRUCCI VALENTINA	
ITA		F	Mearini Rachele	
ITA		F	Moneghini Martina	
ITA		F	MUSOLINO SARA	



Karate1 Youth League - Venice 2024

ENTRIES BY WEIGHT CATEGORY



Junior Kumite Female -53 kg

As of 8 DEC 2024

Country Code	ID	Gender	Name	Seeding
ITA		F	penso isotta	
ITA		F	Salvi Caterina	
ITA		F	Sanza Marie	
ITA		F	SCLERANDI NOEMI	
KOS	KOS02858	F	HASANAJ DEA	
KOS	KOS02729	F	METOLLI EDA	
LTU	LTU02310	F	Liutkevičiūtė Miglė	
POL	POL3146	F	CHLEBOWSKA ANNA	
POL	POL2901	F	KULAWIK ZUZANNA	
POL		F	Olszańska Wiktoria	
POR	POR02764	F	Eça Guimarães Marta Pimenta	
POR	SD60047	F	Franco Isabel	
POR		F	Silva Maria	
ROU	ROU003976	F	ANTONIA COZMA	
ROU	ROU03735	F	BUTURA ANDREEA	
ROU	ROU003979	F	IRINA ALEXANDRA NUTU	
ROU	ROU003854	F	OANA ELENA VLAD	
ROU	ROU003956	F	SOFIA GHINIA	
ROU		F	Topala Maria Ximena	
SCO		F	Cooney Grace	
SLO	SLO02562	F	KURBEGOVIĆ EDNA	
SRB		F	Zvezdanovic Andjela	
SUI		F	Gaus Anja	
SUI		F	Paul-Jacques Juline	
SUI	SUI02566	F	Streit Kim Lara	
SVK		F	Melicháreková Lenka	
TPE	TPE02813	F	LIAO YU-TING	
TUR		F	AYVACIK Nisanur	
TUR		F	ÇAKIR NİSANUR	
TUR	TUR3007	F	KILIÇ BUŞE	
TUR	TUR2973	F	KILIÇ NEHİR	
TUR		F	Oytun Sıla	
TUR		F	TEKCAN EYLÜL	
UKR		F	Hnes Mariia	
UKR		F	KYRYCHENKO KATERYNA	
UKR		F	Marchenko Yeva	
UKR		F	Sibova Daria	
UKR	UKR02851	F	Vashchyshyn Anna	

Junior Kumite Female -53 kg

Karate1 Youth League - Venice 2024, PALAZZO DEL TURISMO, Piazza Brescia 11, 30016 Lido di Jesolo VE, ITA

2024-12-05

Tatami
1 15:30

Pool
1/4

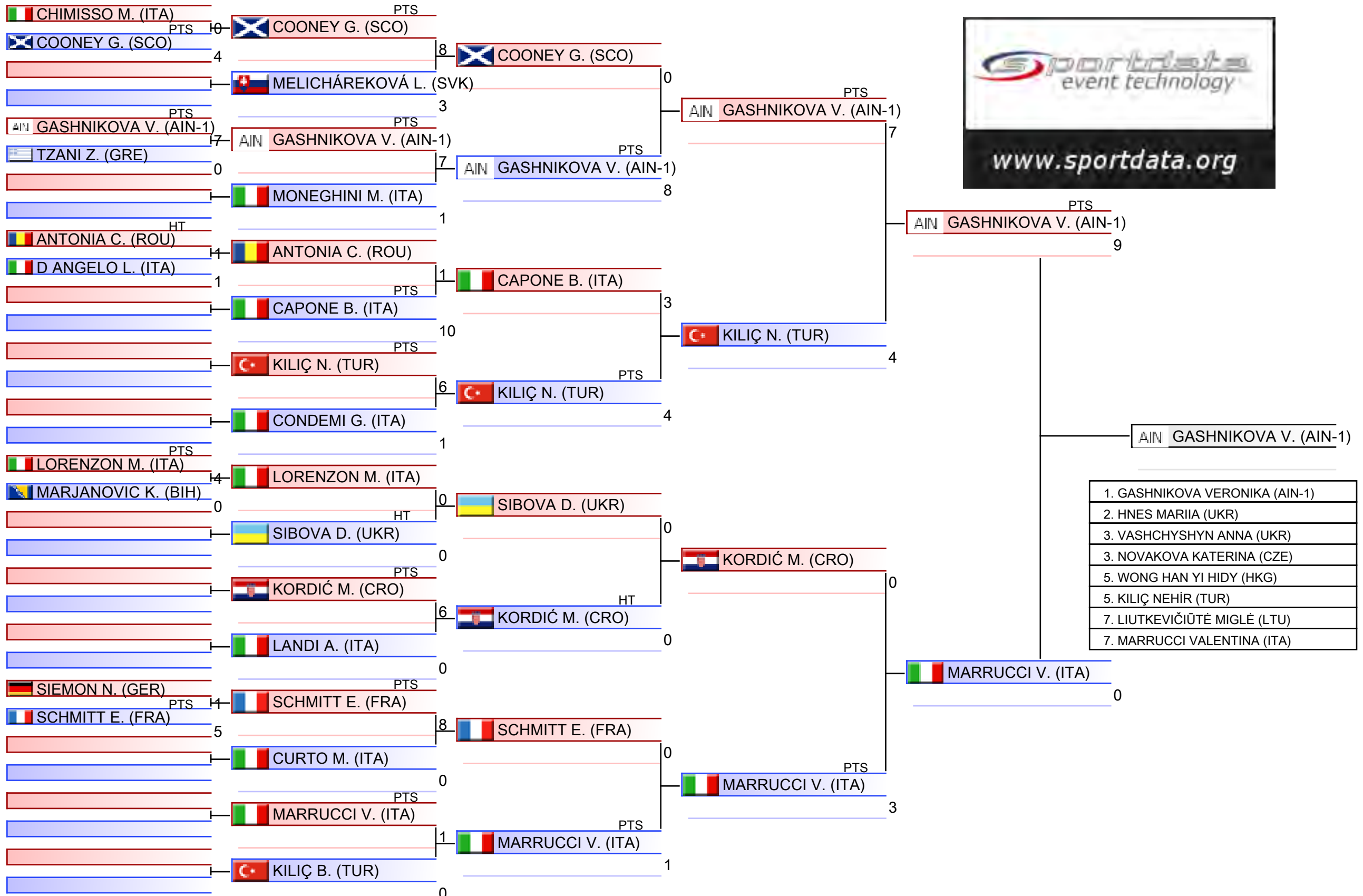

Junior Kumite Female -53 kg

Karate1 Youth League - Venice 2024, PALAZZO DEL TURISMO, Piazza Brescia 11, 30016 Lido di Jesolo VE, ITA

2024-12-05

Tatami
2 15:30

Pool
2/4

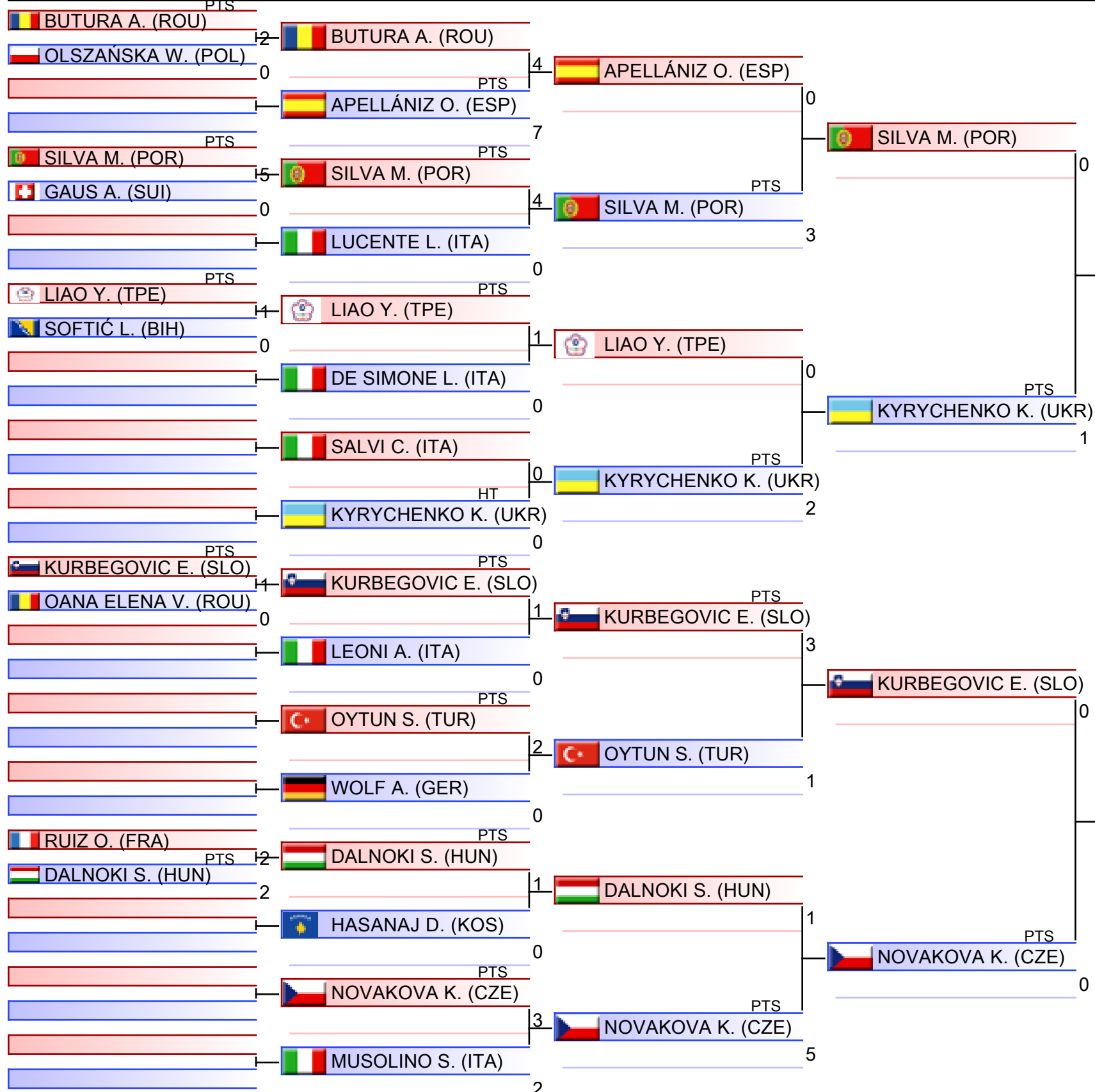

1. GASHNIKOVA VERONIKA (AIN-1)
2. HNES MARIIA (UKR)
3. VASHCHYSHYN ANNA (UKR)
3. NOVAKOVA KATERINA (CZE)
5. WONG HAN YI HIDY (HKG)
5. KILIÇ NEHİR (TUR)
7. LIUTKEVIČIŪTĒ MIGLĒ (LTU)
7. MARRUCCI VALENTINA (ITA)

Junior Kumite Female -53 kg

Karate1 Youth League - Venice 2024, PALAZZO DEL TURISMO, Piazza Brescia 11, 30016 Lido di Jesolo VE, ITA

2024-12-05

Tatami
3 15:30

Pool
3/4

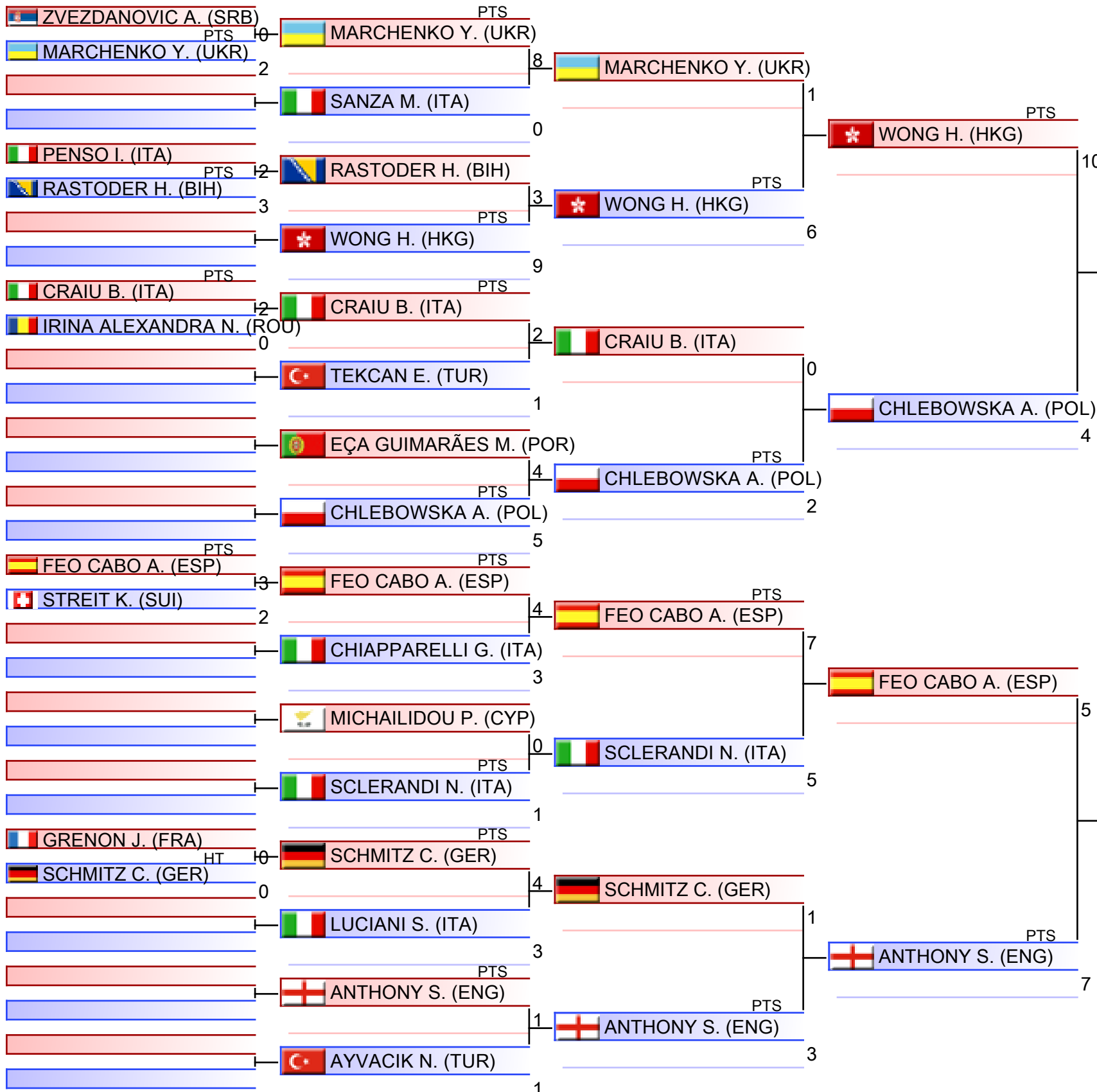

- | |
|--------------------------------|
| 1. GASHNIKOVA VERONIKA (AIN-1) |
| 2. HNES MARIIA (UKR) |
| 3. VASHCHYSHYN ANNA (UKR) |
| 3. NOVAKOVA KATERINA (CZE) |
| 5. WONG HAN YI HIDY (HKG) |
| 5. KILIÇ NEHİR (TUR) |
| 7. LIUTKEVIČIŪTĖ MIGLĖ (LTU) |
| 7. MARRUCCI VALENTINA (ITA) |

Junior Kumite Female -53 kg

Karate1 Youth League - Venice 2024, PALAZZO DEL TURISMO, Piazza Brescia 11, 30016 Lido di Jesolo VE, ITA

2024-12-05

Tatami
4 15:30

Pool
4/4

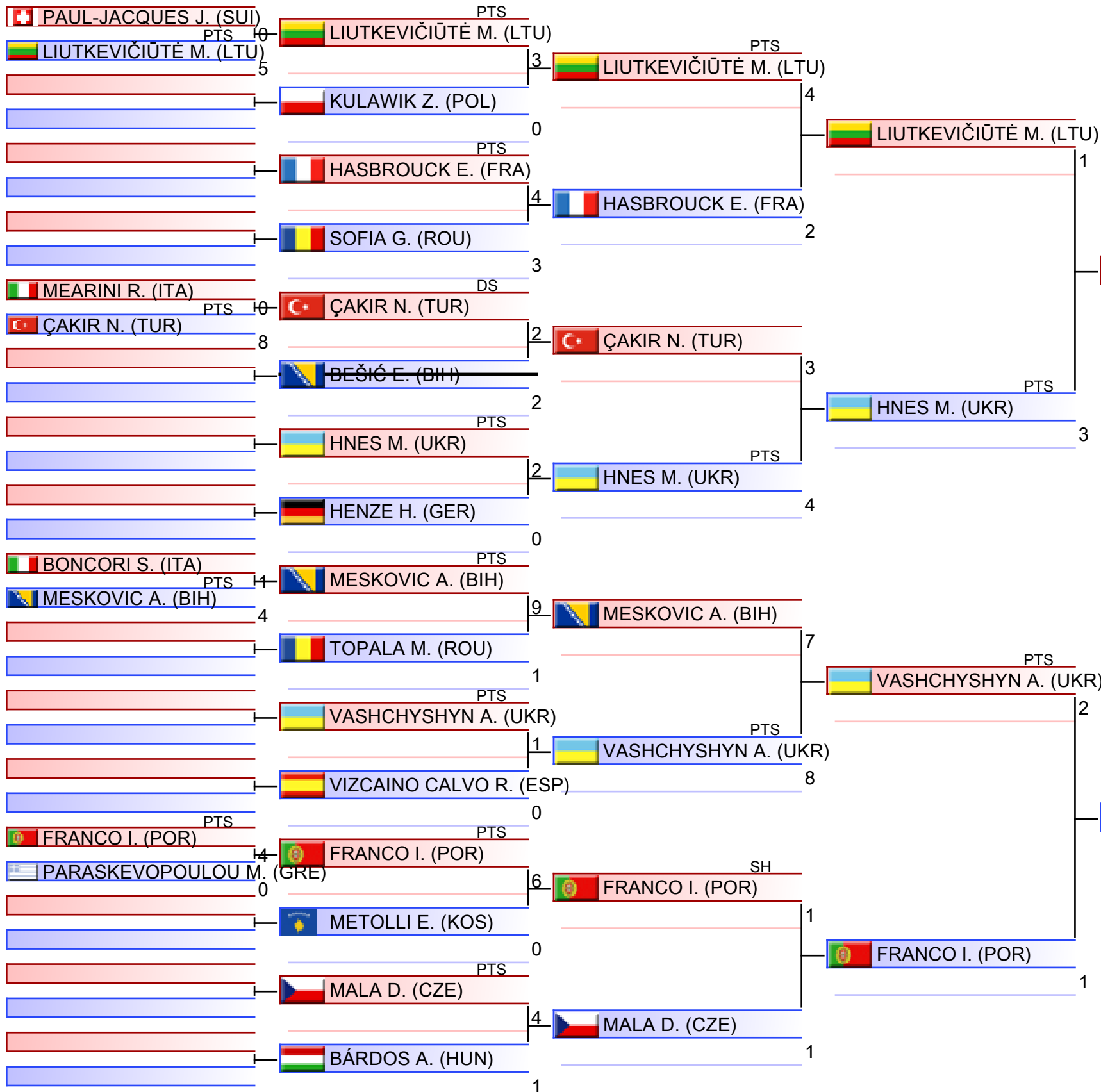

1. GASHNIKOVA VERONIKA (AIN-1)
2. HNES MARIIA (UKR)
3. VASHCHYSHYN ANNA (UKR)
3. NOVAKOVA KATERINA (CZE)
5. WONG HAN YI HIDY (HKG)
5. KILIÇ NEHİR (TUR)
7. LIUTKEVIČIŪTĖ MIGLĖ (LTU)
7. MARRUCCI VALENTINA (ITA)

Pool winner-Junior Kumite Female -53 kg

Karate1 Youth League - Venice 2024, PALAZZO DEL TURISMO, Piazza Brescia 11, 30016 Lido di Jesolo VE, ITA

2024-12-05

Tatami
1 17:20

Pool
1/1

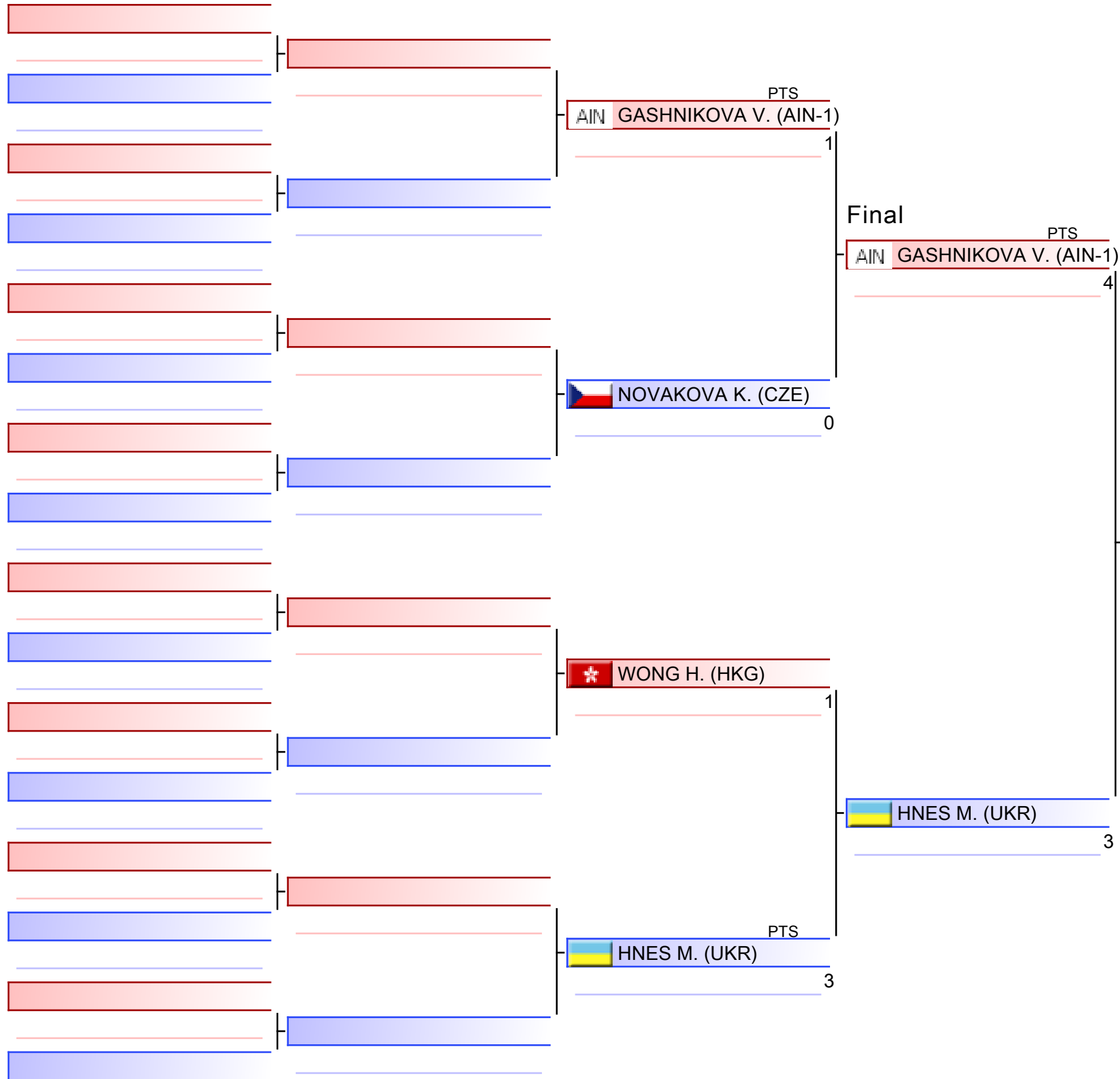

AIN GASHNIKOVA V. (AIN-1)

1. GASHNIKOVA VERONIKA (AIN-1)
2. HNES MARIIA (UKR)
3. VASHCHYSHYN ANNA (UKR)
3. NOVAKOVA KATERINA (CZE)
5. WONG HAN YI HIDY (HKG)
5. KILIÇ NEHİR (TUR)
7. LIUTKEVIČIŪTĖ MIGLĖ (LTU)
7. MARRUCCI VALENTINA (ITA)

Junior Kumite Female -53 kg

Karate1 Youth League - Venice 2024

2024-12-05

Tatami

6 19:00

Pool

1,2,3,4

(c)sportdata GmbH & Co KG 2000-2024 (2024-12-08 20:16) v 10.2.0 build 1 (2024-11-20 00:58 CET) License: SDIL TVG (expire 2025-01-26)

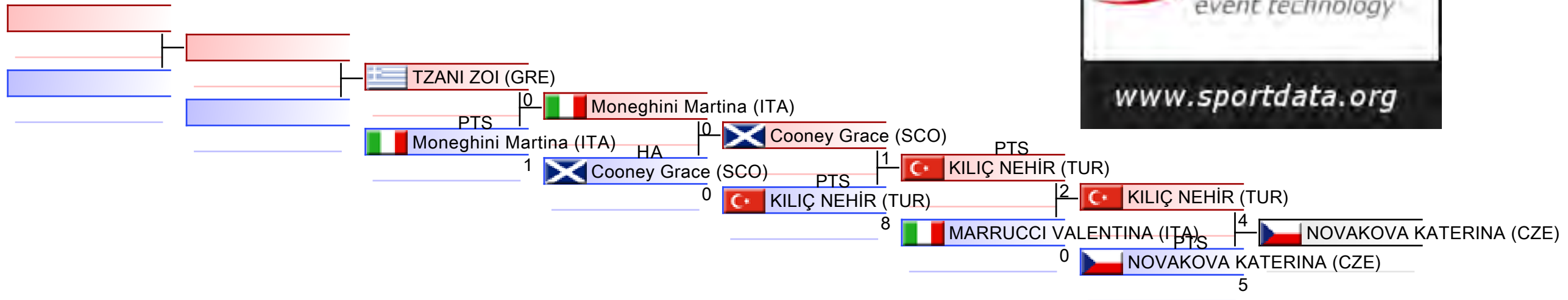

REPECHAGE: (1,2,3,4)

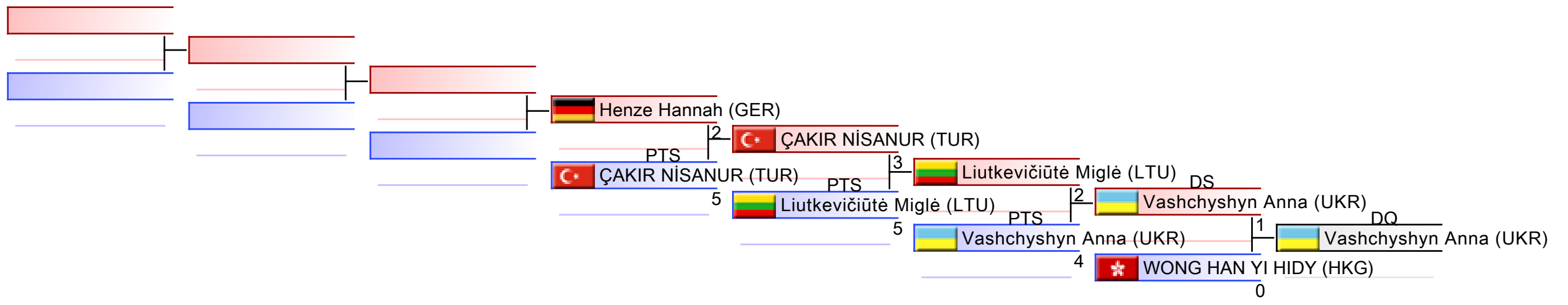



Karate1 Youth League - Venice 2024 - 2024-12-04



Official Results

Junior Kumite Female -53 kg (Entries: 83 Nations: 26)			
1	GASHNIKOVA VERONIKA	AIN	AIN-1 - Individual Neutral Athletes - 1
2	HNES MARIIA		UKR - UKRAINE
3	VASHCHYSHYN ANNA		UKR - UKRAINE
3	NOVAKOVA KATERINA		CZE - CZECH REPUBLIC
5	WONG HAN YI HIDY		HKG - HONG KONG, CHINA
5	KILIÇ NEHİR		TUR - TURKIYE
7	LIUTKEVICIŪTĖ MIGLĖ		LTU - LITHUANIA
7	MARRUCCI VALENTINA		ITA - ITALY
9	ÇAKIR NISANUR		TUR - TURKIYE
9	COONEY GRACE		SCO - SCOTLAND
11	HENZE HANNAH		GER - GERMANY
11	MONEGHINI MARTINA		ITA - ITALY
13	TZANI ZOI		GRE - GREECE

JUNIOR KUMITE FEMALE -59 KG



Karate1 Youth League - Venice 2024

ENTRIES BY WEIGHT CATEGORY



Junior Kumite Female -59 kg

As of 8 DEC 2024

Country Code	ID	Gender	Name	Seeding
AIN-1		F	LIASKALO SOFIIA	
AND	AND02228	F	VEGA STRAKY LOLA	
ARM		F	Harutyunyan Kamila	
AUT	AUT02817	F	CETIN CEYLIN	
BEL		F	Mansour Dounya	
BEL		F	Swarup Pia	
BIH		F	Gegić Zara	
BIH	BIH03260	F	Jovic Bojana	
BIH		F	Mehanija Hena	
BUL		F	Nikiforova Plamena	
BUL		F	Stoimenova Veneta	
CAN		F	Lee Amanda	
CRC	CRC002715	F	GONZAGA GARCIA DAYANSI	
CRO	CRO03381	F	Braica Katja	
CRO		F	KARADZA ANA	
CRO	CRO03132	F	KLARIC KORINA	
CRO	CRO03732	F	Mirosavljević Nika	
CRO		F	Rogović Lana	
CRO		F	SKENDEROVIĆ KATARINA	
CZE	CZE02268	F	HRDLICKOVA LUCY	
CZE		F	Poskerová Nela	
CZE	CZE02424	F	PRIGLOVA MARIE	
DEN		F	Kjærsgaard Mathilde	
EGY		F	Abdou Sally	
ENG		F	Carruthers Arabella	
ENG		F	Dawson Millie	
ENG		F	Nardelli Talia	
ENG		F	Tonks Erin	
ESP		F	ALCALA JIMENEZ IRENE	
ESP		F	ANGUERA NIETO JUDITH	
ESP	ESP03000	F	EGEA COLADO MARIA	
ESP	ESP03003	F	JUST CLOPES JÚLIA	
ESP		F	RIVAS JIMENEZ CRISTINA	
FRA	FRA03459	F	Arzumian Monica	
FRA		F	Gervasi Cyann	
FRA		F	ROUSSELOT Elaïs	
GER	SD48893	F	Hamzah Amira	
GER	GER03304	F	HELLEN ILI	
GER	GER03220	F	Meinert Jacqueline	
GER	GER03285	F	MUSSWEILER MIA	
HUN		F	Ádám Adrienn	
HUN	HUN02867	F	Török Panka	
ITA		F	Aloisio Giada	
ITA	ITA04562	F	BARONE MIRYAM FABIA	
ITA		F	Bigagli Viola	



Karate1 Youth League - Venice 2024

ENTRIES BY WEIGHT CATEGORY



Junior Kumite Female -59 kg

As of 8 DEC 2024

Country Code	ID	Gender	Name	Seeding
ITA		F	Bouraya Sofia	
ITA	SD61410	F	burzo carolina	
ITA	ITA04224	F	CHEROUAQI BASMA	
ITA		F	Cocca MariaLuigia	
ITA		F	Copercini Matilde	
ITA	ITA04241	F	CRISTALLO RITA	
ITA		F	cumbo costanza	
ITA		F	Della Rosa Martina	
ITA		F	DUTTO GIULIA	
ITA	SD49017	F	ECCHILI GRAZIELLA ANNAEL	
ITA	ITA04444	F	El Asri Amina	
ITA	ITA04445	F	El Asri khadija	
ITA	ITA04695	F	Fiume Matilde	
ITA		F	Galati Giulia	
ITA	SD52734	F	GANDOLA GRETA	
ITA	ITA04505	F	GRANATIERO SOFIA	
ITA		F	Lippi Ginevra	
ITA	ITA04472	F	LOFFREDO Andrea Chiara	
ITA		F	Maffizzoli Lisa	
ITA	ITA04487	F	Mercuri Sofia	
ITA		F	piazza giulia	
ITA		F	REINA FRANCESCA	
ITA		F	ROSA COLOMBO Sofia	
ITA	ITA04243	F	Servo Gaia	
KOS	KOS2187	F	IBRAHIMI QENDRESA	
LAT		F	Sevcova Sofija	
LAT		F	Vasiljeva Alina	
LUX		F	Gawellek Sarah	
POL	POL2877	F	Dopieralska Zuzanna	
POR		F	Morais Oliveira Inês	
POR		F	Santos Carolina	
POR		F	TEIXEIRA ANA BEATRIZ	
ROU	ROU03706	F	BIANCA MUNTEANU	
SLO	SLO02712	F	LEBEN TINKARA	
SUI		F	Bürki Danicha	
SUI		F	Karadeniz Ecrin	
SVK	SVK02644	F	Jeseničová Nina	
TUR	TUR03818	F	ASLAN Ezgi	
TUR		F	tural esem sude	
UKR		F	Bezbozhna Yelyzaveta	
UKR		F	Koshel Sofiya	
UKR		F	Makarenko Violetta	
UKR		F	Mudzhuk Alona	
UKR		F	Pushkova Anastasiia	

Junior Kumite Female -59 kg

Karate1 Youth League - Venice 2024, PALAZZO DEL TURISMO, Piazza Brescia 11, 30016 Lido di Jesolo VE, ITA

2024-12-05

Tatami
5 14:15

Pool
1/4

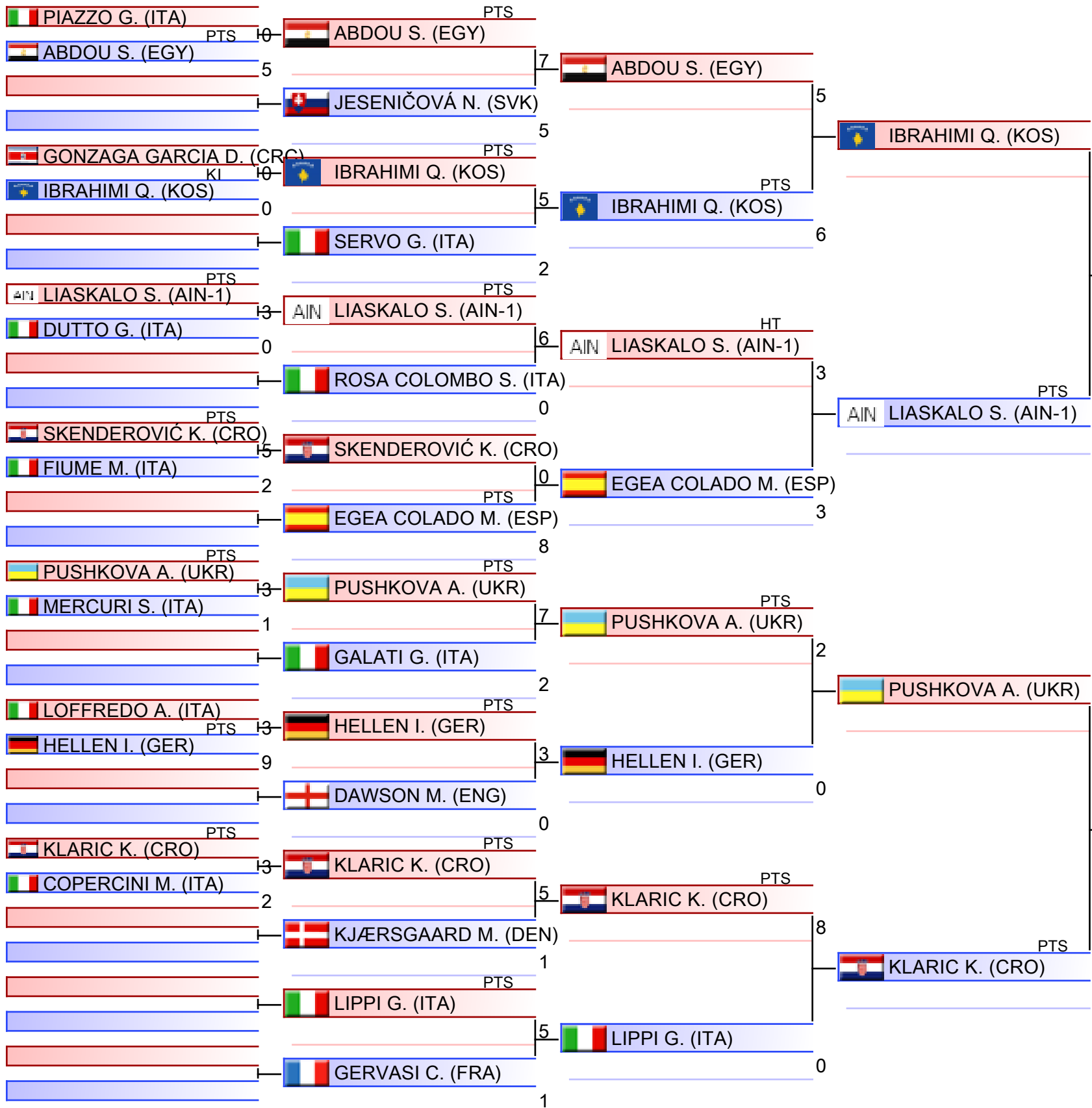

- | |
|-----------------------------------|
| 1. LIASKALO SOFIIA (AIN-1) |
| 2. MUDZHUK ALONA (UKR) |
| 3. JUST CLOPES JÚLIA (ESP) |
| 3. KLARIC KORINA (CRO) |
| 5. ROUSSELOT ELAÏS (FRA) |
| 5. ASLAN EZGI (TUR) |
| 7. ECCHILI GRAZIELLA ANNAEL (ITA) |
| 7. IBRAHIMI QENDRESA (KOS) |

Junior Kumite Female -59 kg

Karate1 Youth League - Venice 2024, PALAZZO DEL TURISMO, Piazza Brescia 11, 30016 Lido di Jesolo VE, ITA

2024-12-05

Tatami
6 14:15

Pool
2/4

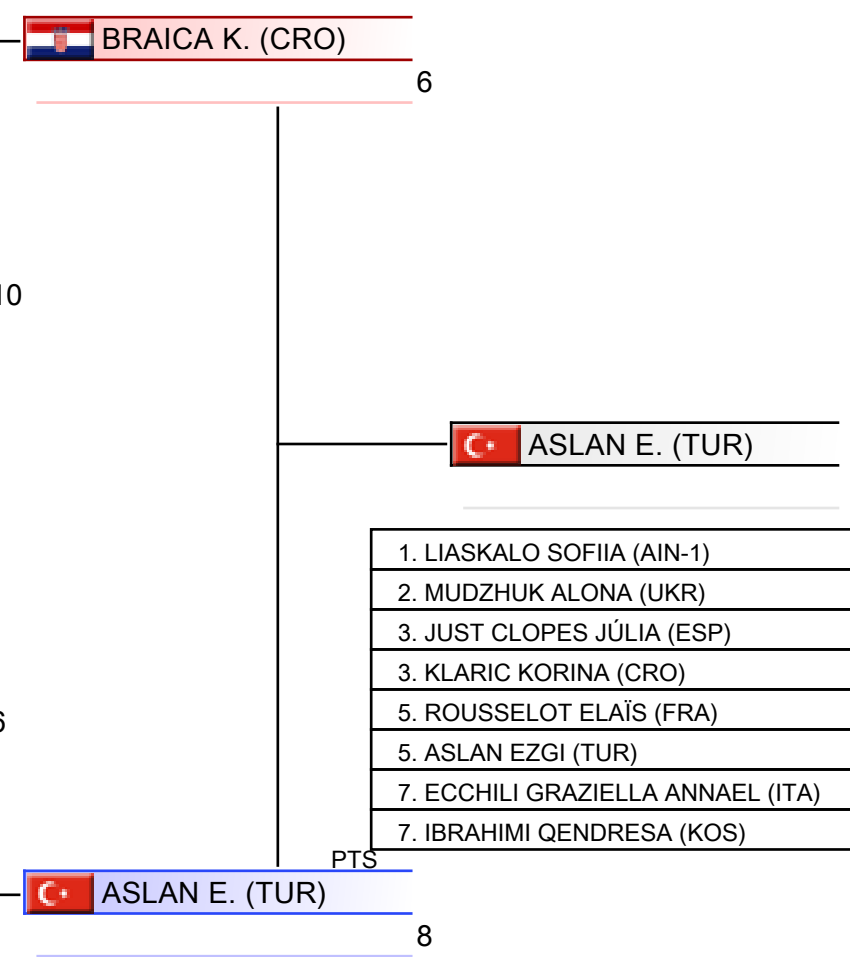
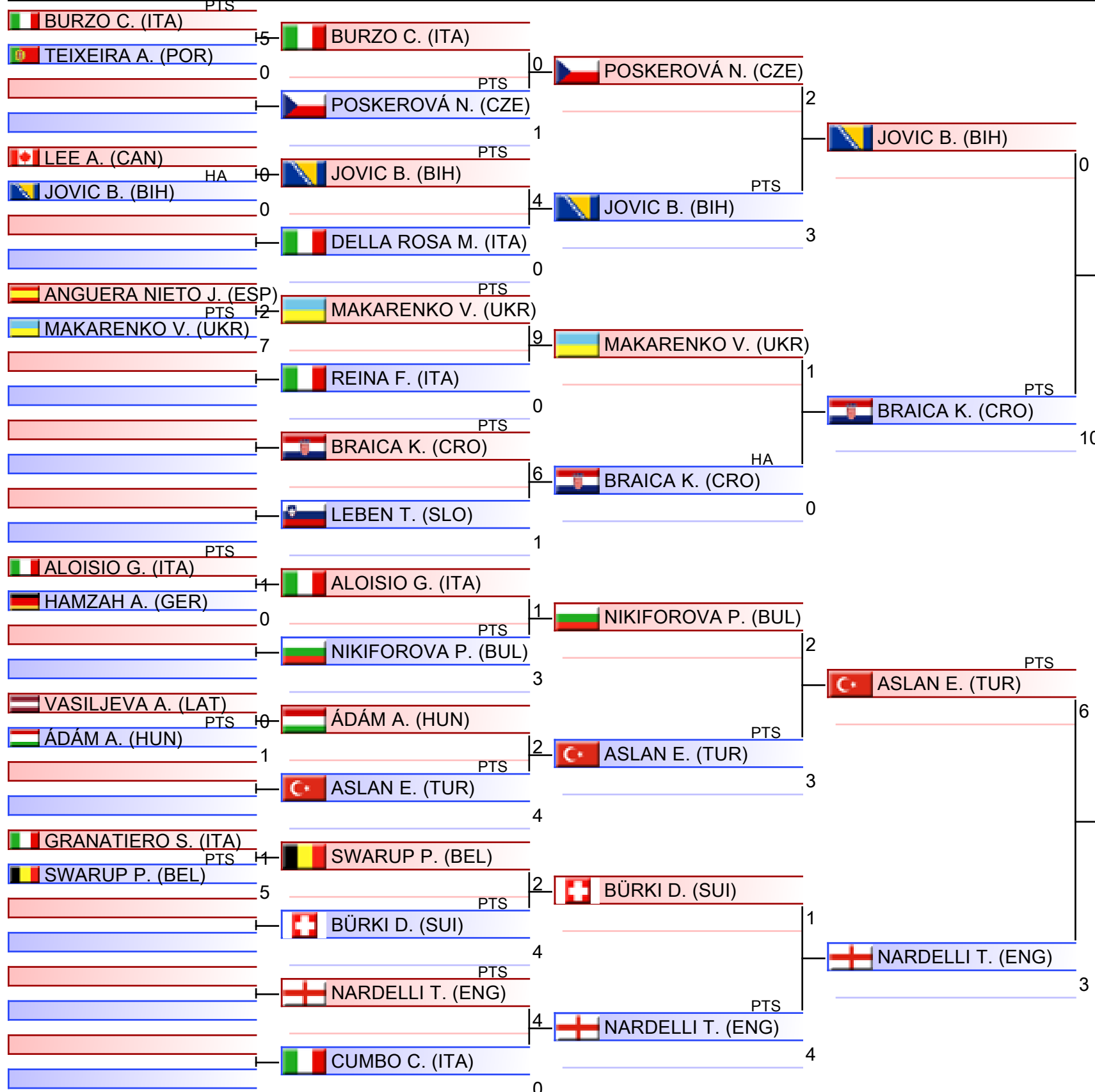

1.	LIASKALO SOFIIA (AIN-1)
2.	MUDZHUK ALONA (UKR)
3.	JUST CLOPES JÚLIA (ESP)
3.	KLARIC KORINA (CRO)
5.	ROUSSELOT ELAÏS (FRA)
5.	ASLAN EZGI (TUR)
7.	ECCHILI GRAZIELLA ANNAEL (ITA)
7.	IBRAHIMI QENDRESA (KOS)

Junior Kumite Female -59 kg

Karate1 Youth League - Venice 2024, PALAZZO DEL TURISMO, Piazza Brescia 11, 30016 Lido di Jesolo VE, ITA

2024-12-05

Tatami
7 14:15

Pool
3/4

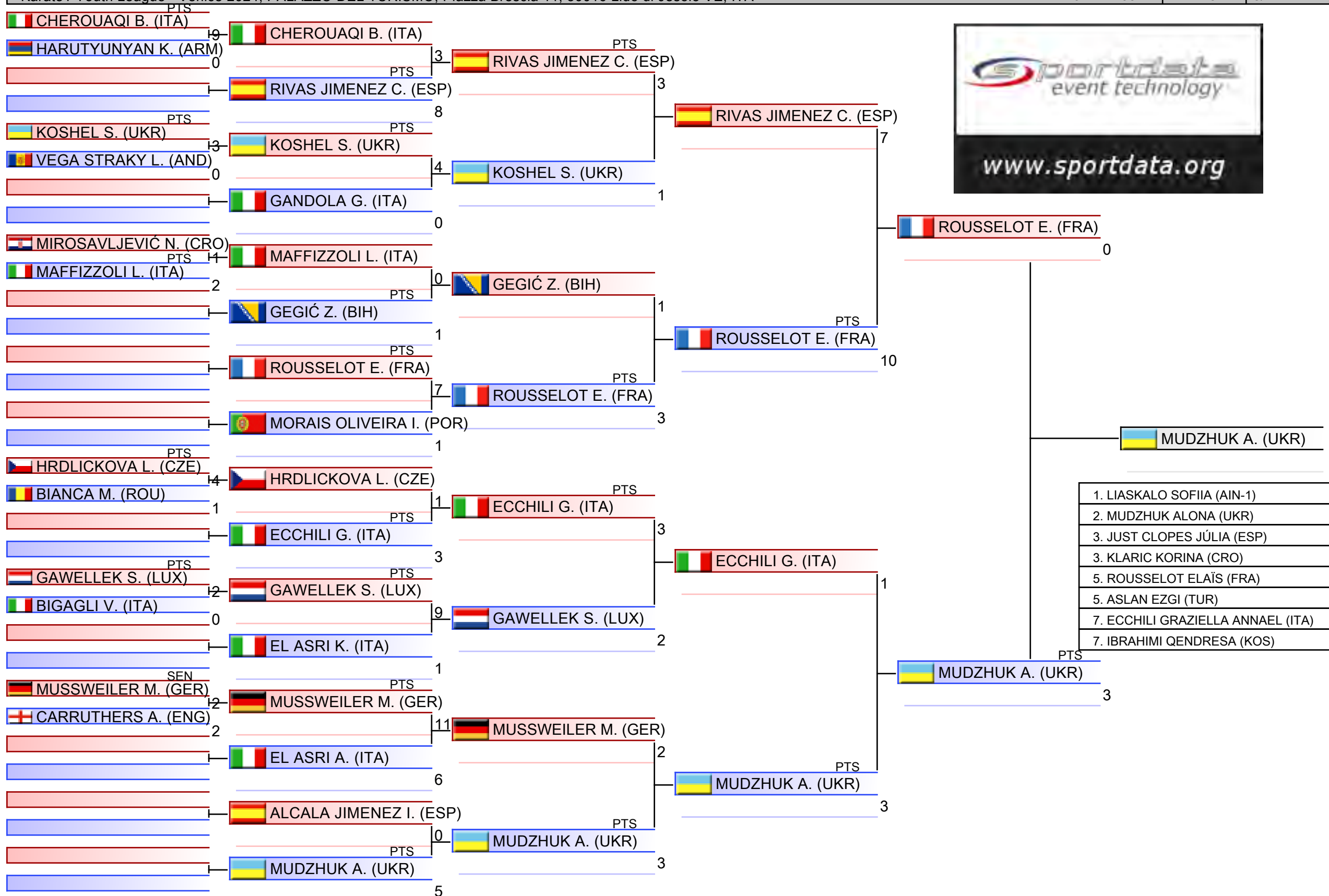

1.	LIASKALO SOFIIA (AIN-1)
2.	MUDZHUK ALONA (UKR)
3.	JUST CLOPES JÚLIA (ESP)
3.	KLARIC KORINA (CRO)
5.	ROUSSELOT ELAÏS (FRA)
5.	ASLAN EZGI (TUR)
7.	ECCHILI GRAZIELLA ANNAEL (ITA)
7.	IBRAHIMI QENDRESA (KOS)

Junior Kumite Female -59 kg

Karate1 Youth League - Venice 2024, PALAZZO DEL TURISMO, Piazza Brescia 11, 30016 Lido di Jesolo VE, ITA

2024-12-05

Tatami
8 14:15

Pool
4/4

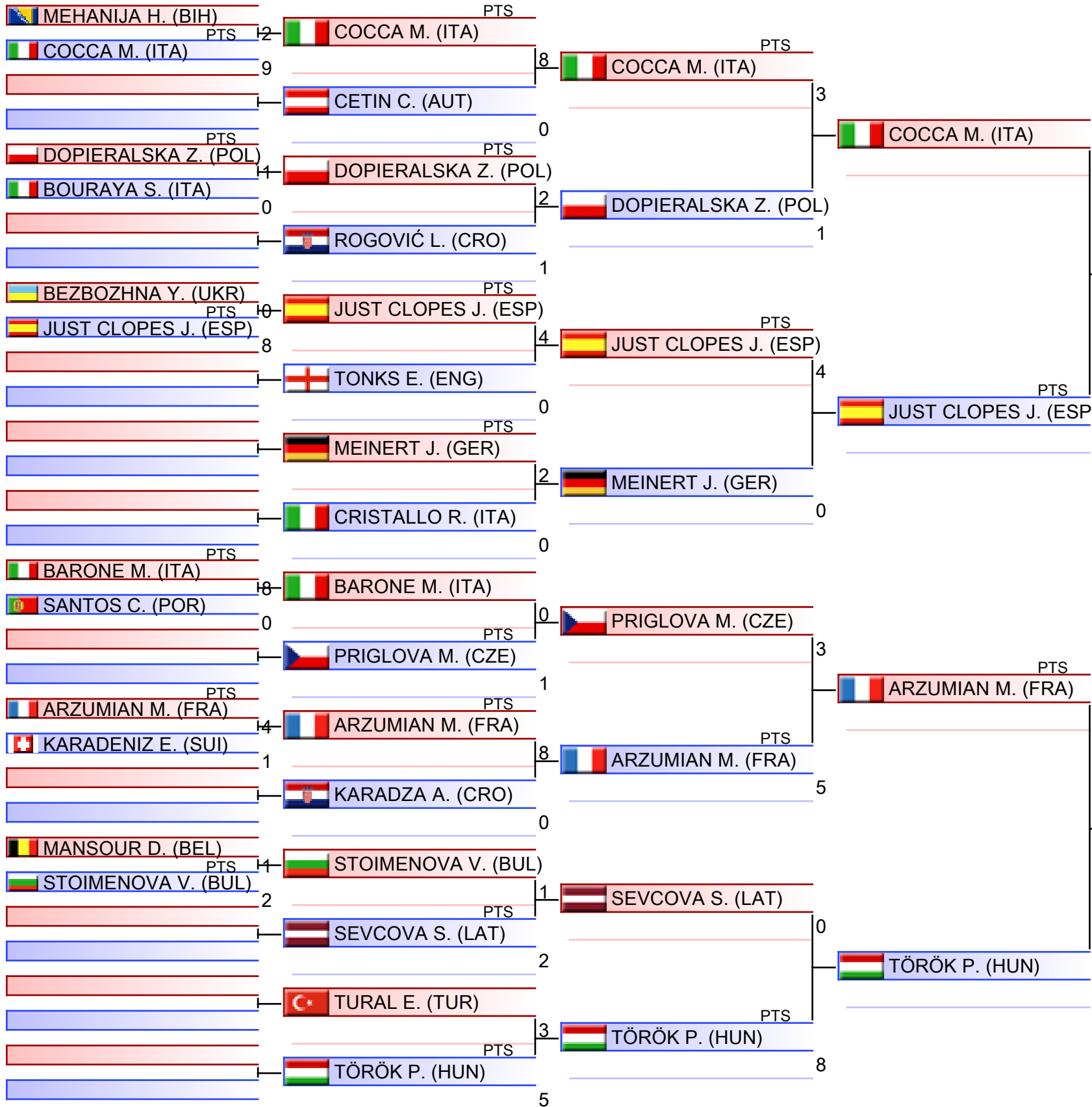

- | |
|-----------------------------------|
| 1. LIASKALO SOFIIA (AIN-1) |
| 2. MUDZHUK ALONA (UKR) |
| 3. JUST CLOPES JÚLIA (ESP) |
| 3. KLARIC KORINA (CRO) |
| 5. ROUSSELOT ELAÏS (FRA) |
| 5. ASLAN EZGI (TUR) |
| 7. ECCHILI GRAZIELLA ANNAEL (ITA) |
| 7. IBRAHIMI QENDRESA (KOS) |

Pool winner-Junior Kumite Female -59 kg

Karate1 Youth League - Venice 2024, PALAZZO DEL TURISMO, Piazza Brescia 11, 30016 Lido di Jesolo VE, ITA

2024-12-05

Tatami

7 16:10

Pool

1/1

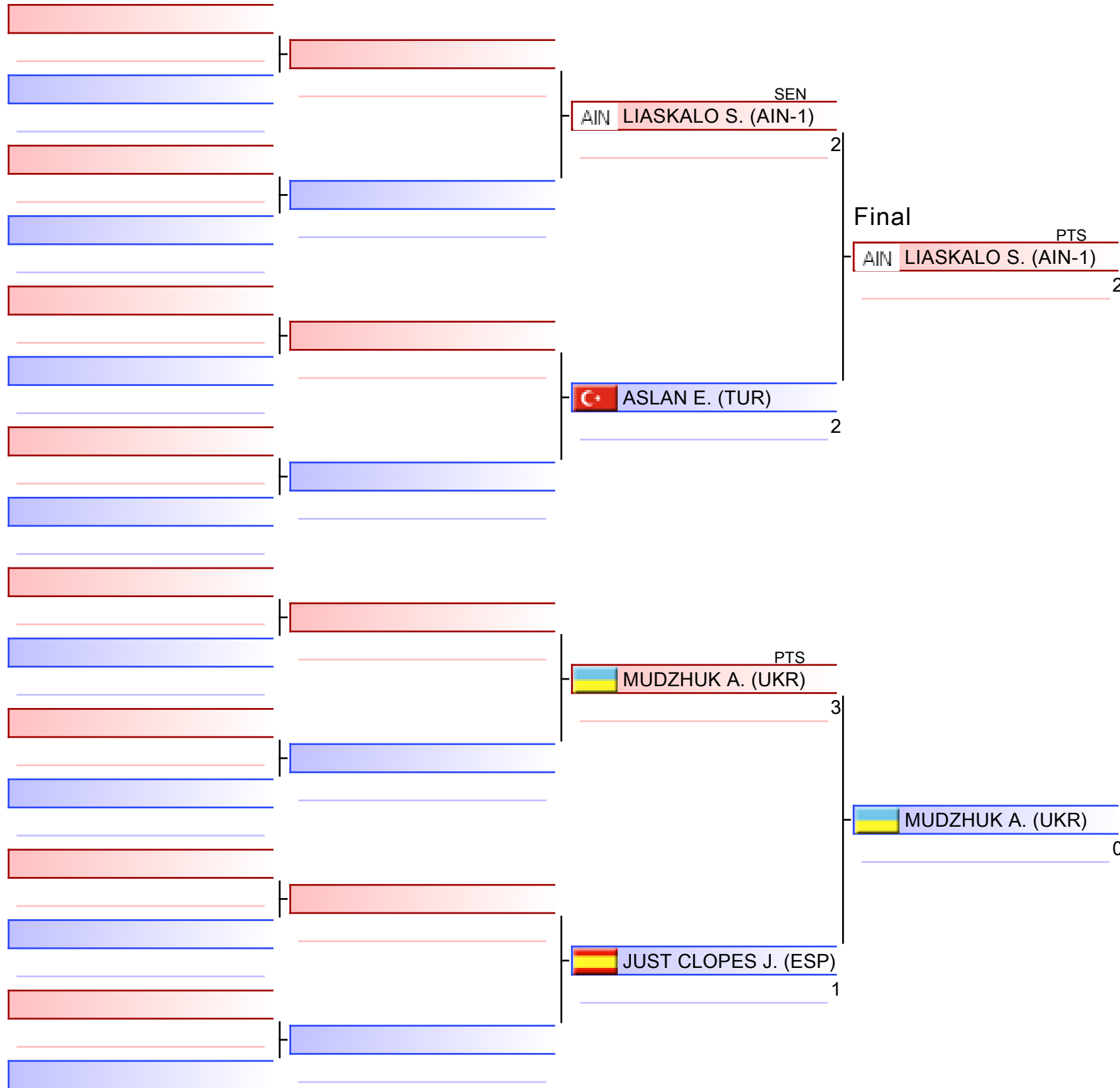

AIN LIASKALO S. (AIN-1)

1. LIASKALO SOFIIA (AIN-1)
2. MUDZHUK ALONA (UKR)
3. JUST CLOPES JÚLIA (ESP)
3. KLARIC KORINA (CRO)
5. ROUSSELOT ELAÏS (FRA)
5. ASLAN EZGI (TUR)
7. ECCHILI GRAZIELLA ANNAEL (ITA)
7. IBRAHIMI QENDRESA (KOS)

Junior Kumite Female -59 kg

Karate1 Youth League - Venice 2024

2024-12-05

Tatami

8 19:00

Pool

4,1,2,3

(c)sportdata GmbH & Co KG 2000-2024 (2024-12-08 20:16) v 10.2.0 build 1 (2024-11-20 00:58 CET) License: SDIL TVG (expire 2025-01-26)

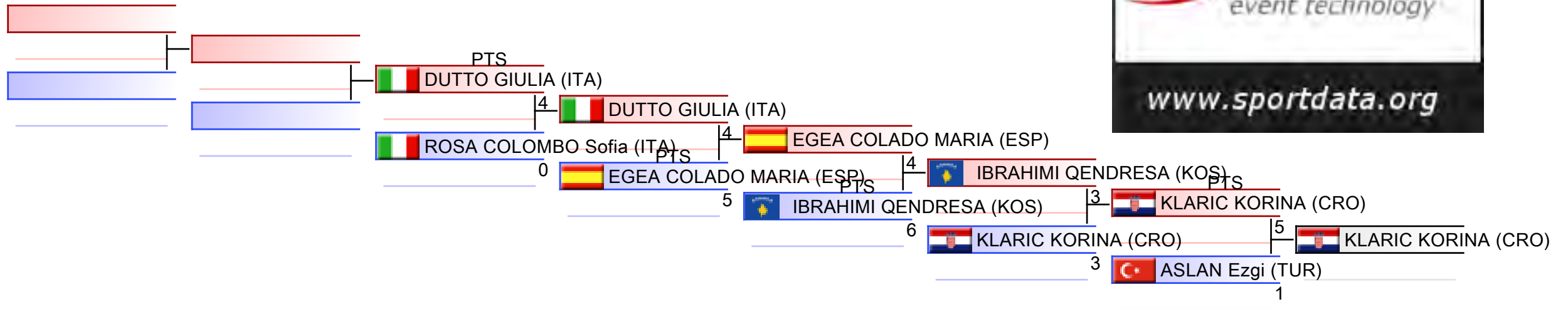

REPECHAGE: (4,1,2,3)

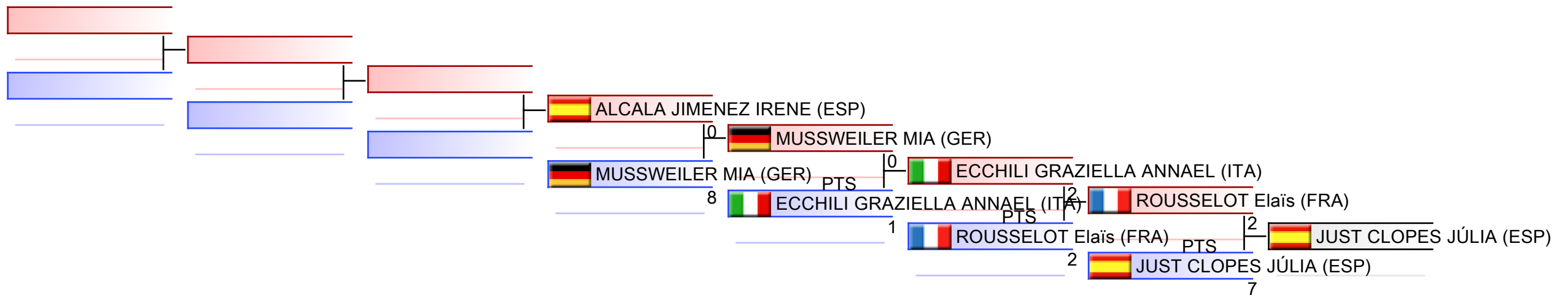



Karate1 Youth League - Venice 2024 - 2024-12-04



Official Results

Junior Kumite Female -59 kg (Entries: 89 Nations: 30)			
1	LIASKALO SOFIIA	AIN	AIN-1 - Individual Neutral Athletes - 1
2	MUDZHUK ALONA		UKR - UKRAINE
3	JUST CLOPES JÚLIA		ESP - SPAIN
3	KLARIC KORINA		CRO - CROATIA
5	ROUSSELOT ELAÏS		FRA - FRANCE
5	ASLAN EZGI		TUR - TURKIYE
7	ECCHILI GRAZIELLA ANNAEL		ITA - ITALY
7	IBRAHIMI QENDRESA		KOS - KOSOVO
9	MUSSWEILER MIA		GER - GERMANY
9	EGEA COLADO MARIA		ESP - SPAIN
11	ALCALA JIMENEZ IRENE		ESP - SPAIN
11	DUTTO GIULIA		ITA - ITALY
13	ROSA COLOMBO SOFIA		ITA - ITALY

JUNIOR KUMITE FEMALE -66 KG



Karate1 Youth League - Venice 2024

ENTRIES BY WEIGHT CATEGORY



Junior Kumite Female -66 kg

As of 8 DEC 2024

Country Code	ID	Gender	Name	Seeding
AUT		F	Lehner Leonie	
BEL		F	ANTOINE AURELIE	
BEL	BEL02518	F	EL AIDI AYAH	
BEL	BEL02527	F	MAATOUG Nargesse	
BIH		F	HASIC DZENITA	
BIH		F	Maleš Dominika	
BIH		F	Maric Marija	
BIH	BIH03883	F	Markić Lidija	
CRO	CRO03378	F	Filković Ema	
CRO		F	Jurković Katja	
CRO		F	KATALENAC IVA	
CRO		F	Krmpotić Nika	
CRO		F	Redžić Jana	
CRO		F	Rezo Lea	
CRO	CRO03814	F	SEGAVIC LUCIJA	
CRO		F	Šekuljica Ira	
CRO	CRO2818	F	STRAHIJA LAURA	
CRO		F	Tadej Sara	
CZE	CZE02479	F	KLEWAROVA MARKETKA	
CZE		F	Vítů Valentina	
DEN		F	Jørgensen Emily	
ENG	ENG02775	F	Juniper-Smith Ysabel	
ENG		F	Tewley Renee	
ESP		F	DURÁN PAVÓN EVA	
ESP		F	Lazaro fernandez Lucia	
FIN		F	Koivula Sofia	
FRA		F	BOUKERCHE Kenza	
FRA		F	ONANA Charlene	
FRA	SD73446	F	Payrot Chloe	
FRA	FRA04089	F	PICAZO LUQUE ELEONOR	
FRA		F	SAIDANE SARA	
FRA		F	Turpin Eloane	
GER		F	Filina Amina	
GER	GER03137	F	FRATILA CRISTINA-MARIA	
GER		F	Hering Alia	
GER	SD61923	F	Kostbar Evelyn	
GER	GER03117	F	Sassenberg Johanna	
GER		F	Schmitz Josie	
GER	SD60877	F	Schwab Laura	
HUN	HUN02618	F	Bogdán Panna	
HUN		F	Höning Jelena	
IRI		F	Nouri Sarina	
ITA	ITA04698	F	ANSELMI CHIARA	
ITA		F	Caneva Sara	
ITA		F	CASTELLANO ERIKA	



Karate1 Youth League - Venice 2024

ENTRIES BY WEIGHT CATEGORY



Junior Kumite Female -66 kg

As of 8 DEC 2024

Country Code	ID	Gender	Name	Seeding
ITA	ITA05404	F	CATTANEO ELISA	
ITA		F	Crosatti Elisa	
ITA	ITA04410	F	FETTOLINI ERIKA	
ITA	ITA04688	F	Mechi Gemma	
ITA		F	Pertile Marta	
ITA		F	Porcaro Siria	
KOS	KOS02917	F	ISLAMI FINESA	
MLT	MLT02160	F	ANTONELLI THYIS	
NED	NED02733	F	Valk Imane	
NOR		F	Cole Eirin Kristine	
POL	POL3964	F	BALUT NATALIA	
POL	POL2900	F	CHLEWICKA NATALIA	
POL	POL3068	F	MASLANKA JULIA	
POL	POL12674	F	WALCZAK KLAUDIA	
POL	POL07916	F	ZARSKA JULIA	
POR		F	Cadete Beatriz	
SCO		F	Bauld Elize	
SEN	SEN02468	F	DE HAAN FAMA SAMASSA	
SLO	SLO02759	F	CERU JERNEJA	
SLO	SLO2415	F	HUMAR GAJA	
SLO	SLO03035	F	KOTNIK NIKA	
SRB		F	Grozdanic Ana	
SRB		F	Popovic Jana	
SRB		F	Rauković Anđela	
SUI		F	Guye Nina	
SVK		F	Kulikova Vira	
SVK	SVK02805	F	Zeumerova Alexandra	
SWE		F	Jakesevic Ivana	
TPE	TPE02893	F	KU TZU-CHING	
TUR		F	AYDEMIR YAGMUR	
TUR		F	YALIN MESUDE	
TUR		F	YONAK NEHIR	
UKR	UKR03150	F	BARANOVA ULIANA	
UKR	UKR03054	F	GOLENIA SOFIA	
UKR		F	Lysytska Nadiia	
UKR	UKR03084	F	RUSAN HANNA	
UKR		F	Vasyliv Tatyana	
UKR		F	Voloshyn Solomiia	

Junior Kumite Female -66 kg

Karate1 Youth League - Venice 2024, PALAZZO DEL TURISMO, Piazza Brescia 11, 30016 Lido di Jesolo VE, ITA

2024-12-05

Tatami
1 17:30

Pool
1/4

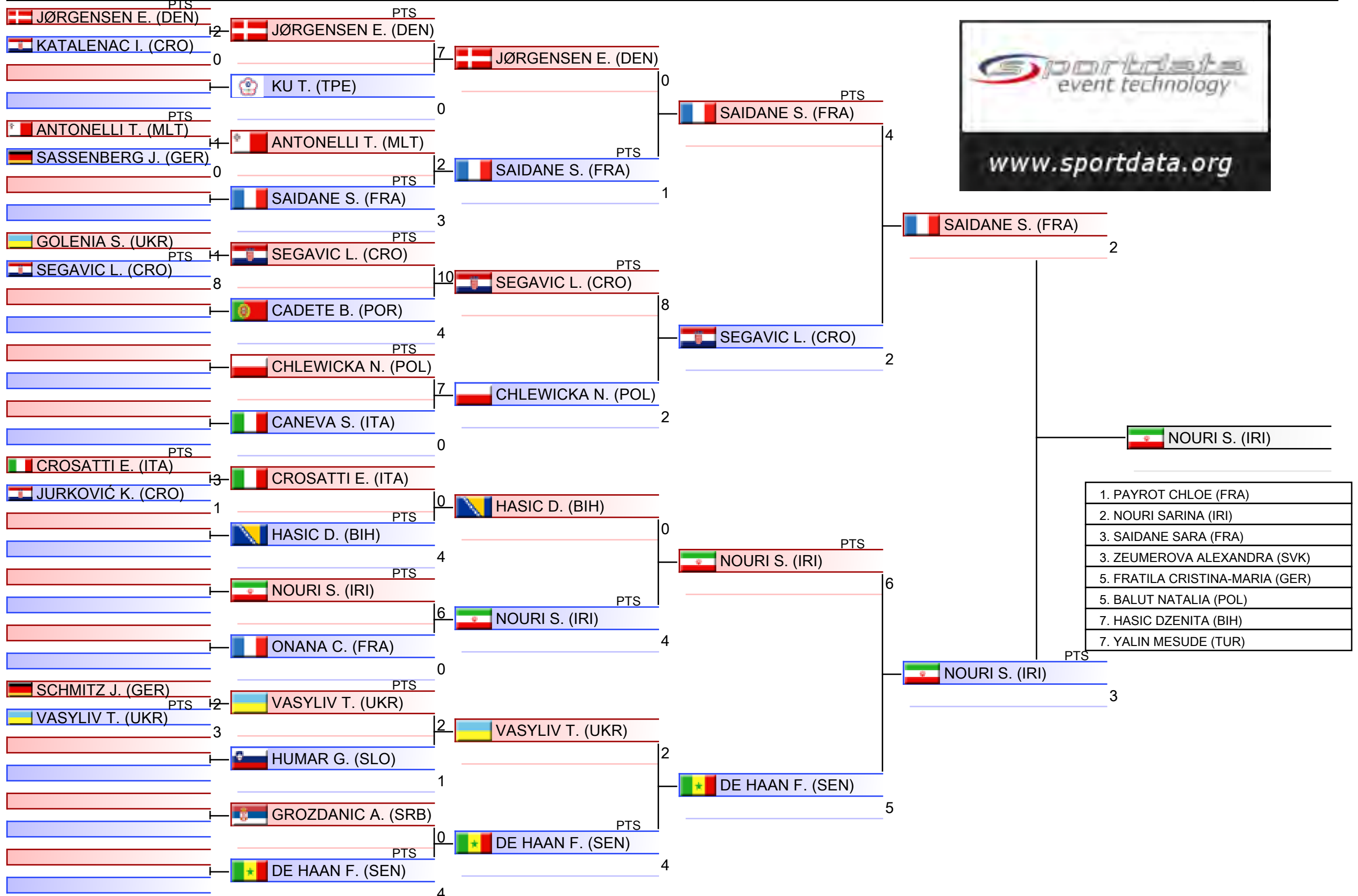

1. PAYROT CHLOE (FRA)
2. NOURI SARINA (IRI)
3. SAIDANE SARA (FRA)
3. ZEUMEROVA ALEXANDRA (SVK)
5. FRATILA CRISTINA-MARIA (GER)
5. BALUT NATALIA (POL)
7. HASIC DZENITA (BIH)
7. YALIN MESUDE (TUR)

Junior Kumite Female -66 kg

Karate1 Youth League - Venice 2024, PALAZZO DEL TURISMO, Piazza Brescia 11, 30016 Lido di Jesolo VE, ITA

2024-12-05

Tatami
2 17:25

Pool
2/4

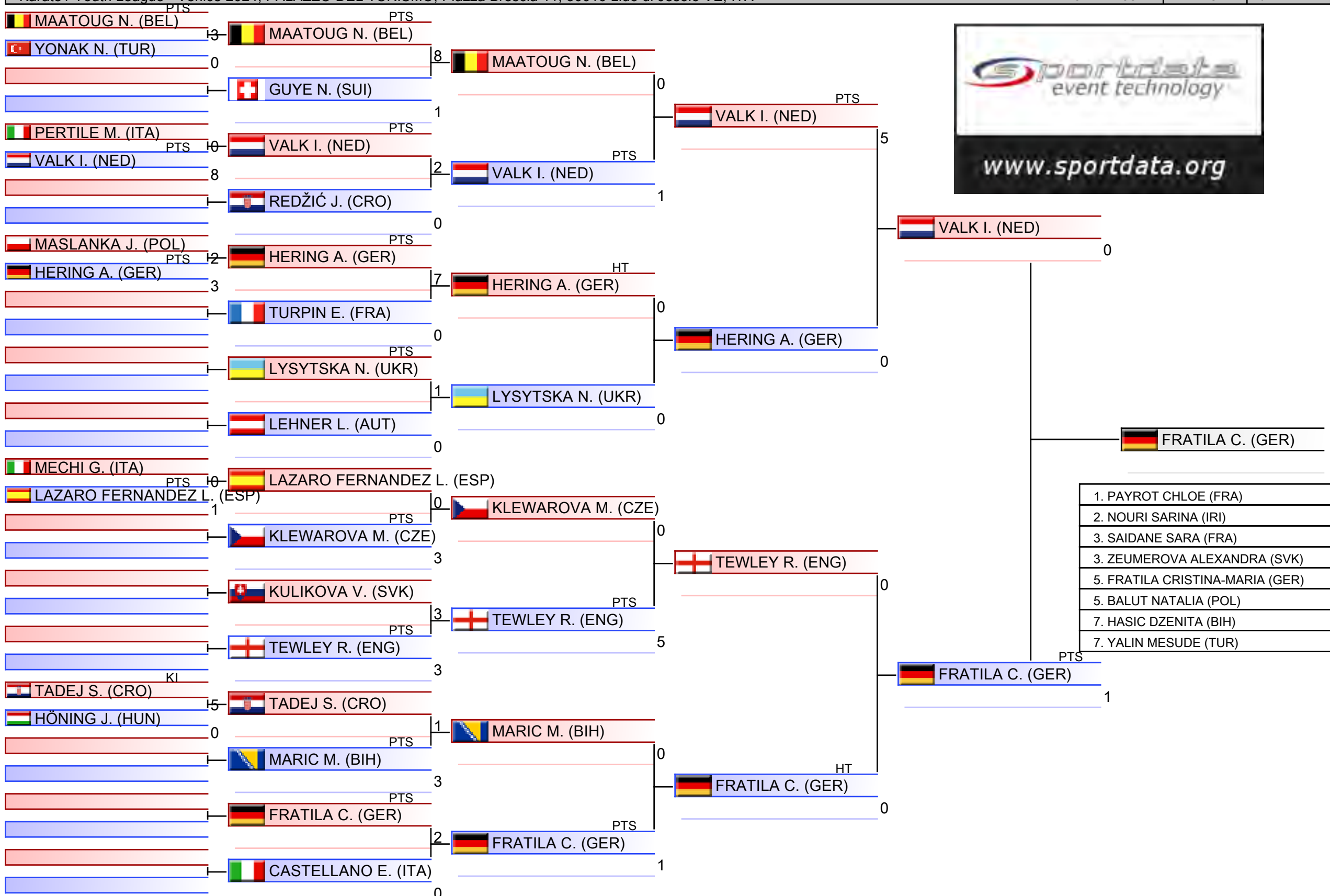

1.	PAYROT CHLOE (FRA)
2.	NOURI SARINA (IRI)
3.	SAIDANE SARA (FRA)
3.	ZEUMEROVA ALEXANDRA (SVK)
5.	FRATILA CRISTINA-MARIA (GER)
5.	BALUT NATALIA (POL)
7.	HASIC DZENITA (BIH)
7.	YALIN MESUDE (TUR)

Junior Kumite Female -66 kg

Karate1 Youth League - Venice 2024, PALAZZO DEL TURISMO, Piazza Brescia 11, 30016 Lido di Jesolo VE, ITA

2024-12-05

Tatami
3 17:30

Pool
3/4

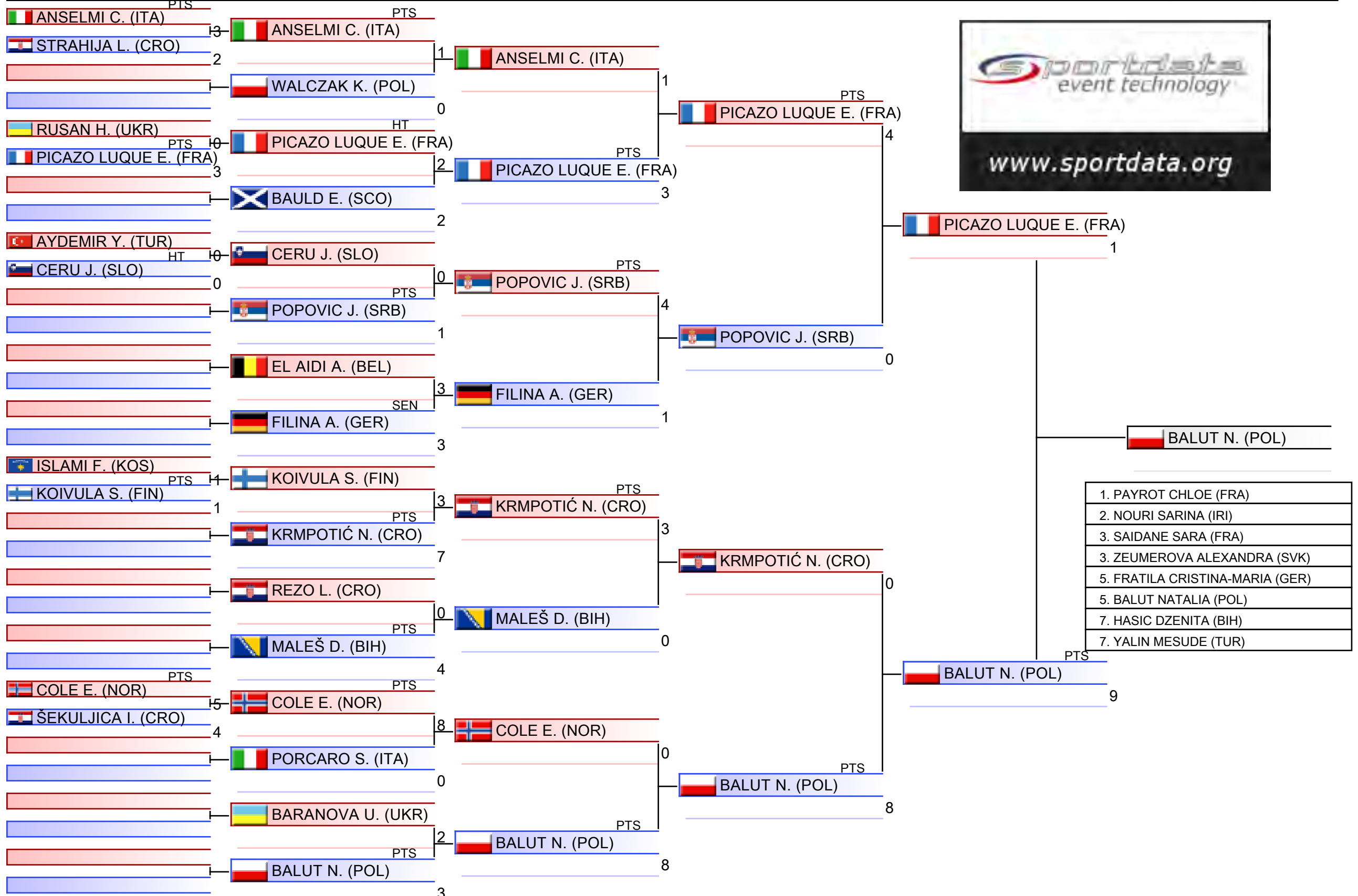

1. PAYROT CHLOE (FRA)
2. NOURI SARINA (IRI)
3. SAIDANE SARA (FRA)
3. ZEUMEROVA ALEXANDRA (SVK)
5. FRATILA CRISTINA-MARIA (GER)
5. BALUT NATALIA (POL)
7. HASIC DZENITA (BIH)
7. YALIN MESUDE (TUR)

Junior Kumite Female -66 kg

Karate1 Youth League - Venice 2024, PALAZZO DEL TURISMO, Piazza Brescia 11, 30016 Lido di Jesolo VE, ITA

2024-12-05

Tatami
4 17:20

Pool
4/4

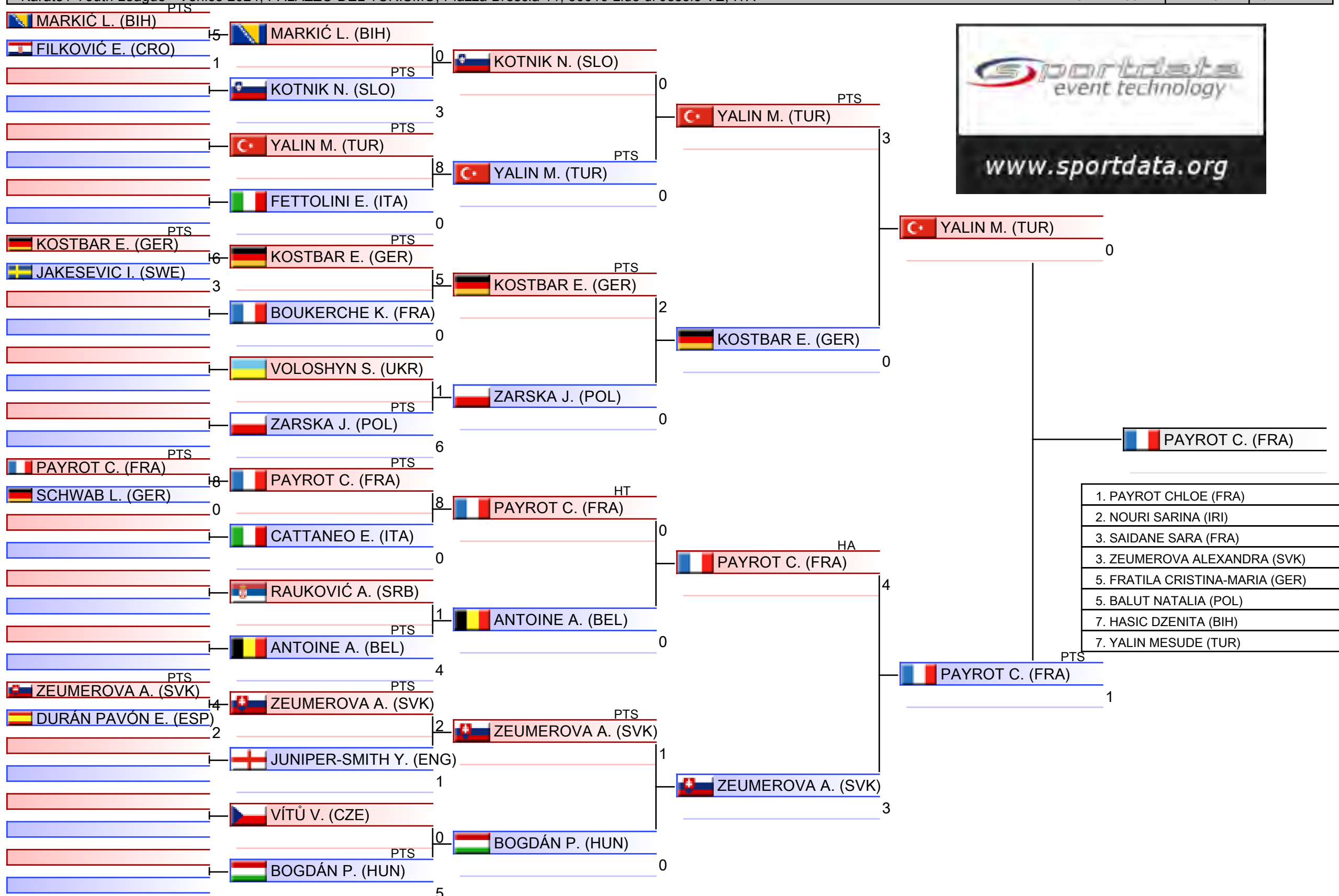

1. PAYROT CHLOE (FRA)
2. NOURI SARINA (IRI)
3. SAIDANE SARA (FRA)
3. ZEUMEROVA ALEXANDRA (SVK)
5. FRATILA CRISTINA-MARIA (GER)
5. BALUT NATALIA (POL)
7. HASIC DZENITA (BIH)
7. YALIN MESUDE (TUR)

Pool winner-Junior Kumite Female -66 kg

Karate1 Youth League - Venice 2024, PALAZZO DEL TURISMO, Piazza Brescia 11, 30016 Lido di Jesolo VE, ITA

2024-12-05

Tatami
1 19:20

Pool
1/1

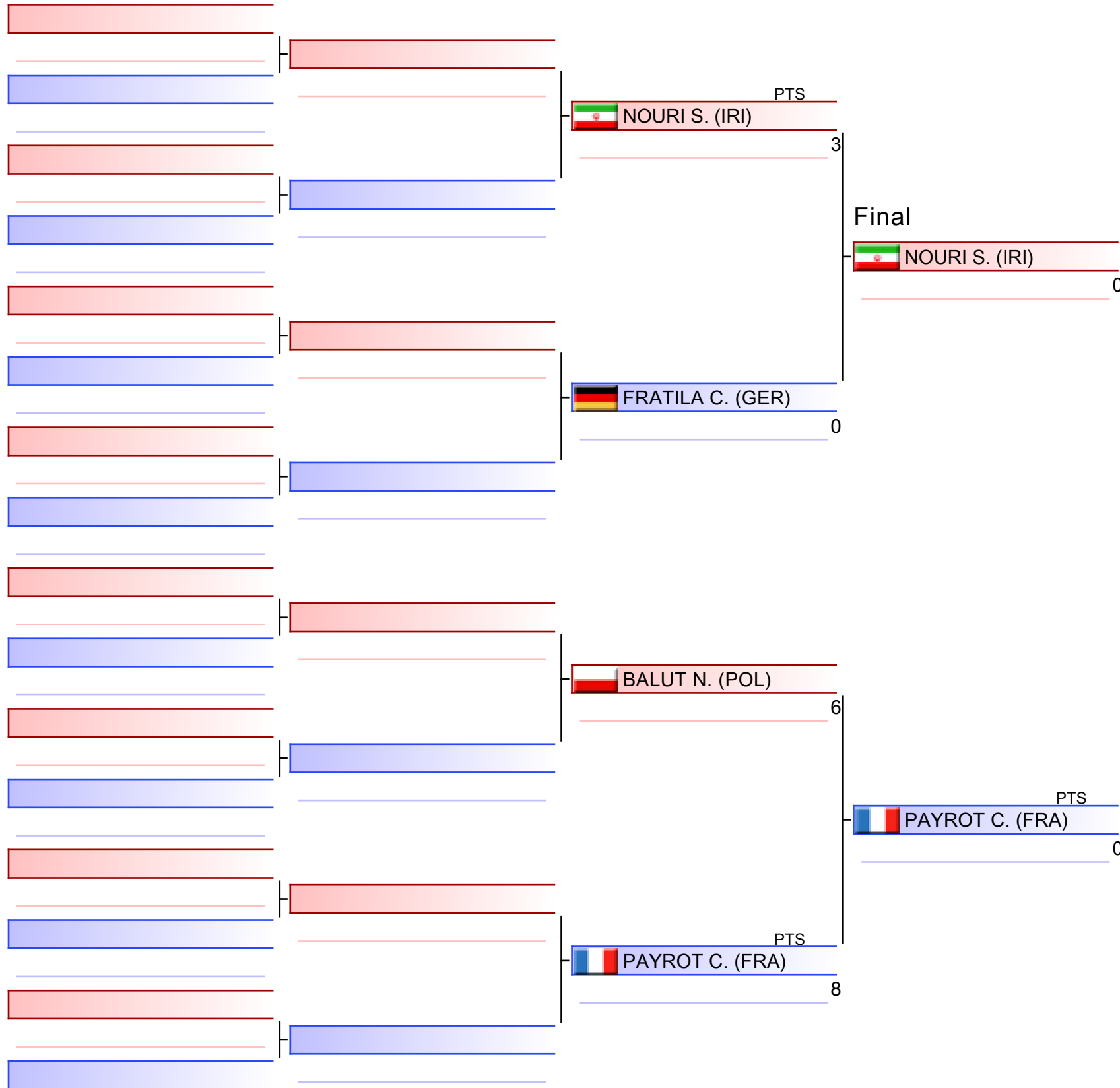

PAYROT C. (FRA)

1. PAYROT CHLOE (FRA)
2. NOURI SARINA (IRI)
3. SAIDANE SARA (FRA)
3. ZEUMEROVA ALEXANDRA (SVK)
5. FRATILA CRISTINA-MARIA (GER)
5. BALUT NATALIA (POL)
7. HASIC DZENITA (BIH)
7. YALIN MESUDE (TUR)

Junior Kumite Female -66 kg

Karate1 Youth League - Venice 2024

2024-12-05

Tatami

1 19:25

Pool

4,1,2,3

(c)sportdata GmbH & Co KG 2000-2024 (2024-12-08 20:16) v 10.2.0 build 1 (2024-11-20 00:58 CET) License: SDIL TVG (expire 2025-01-26)

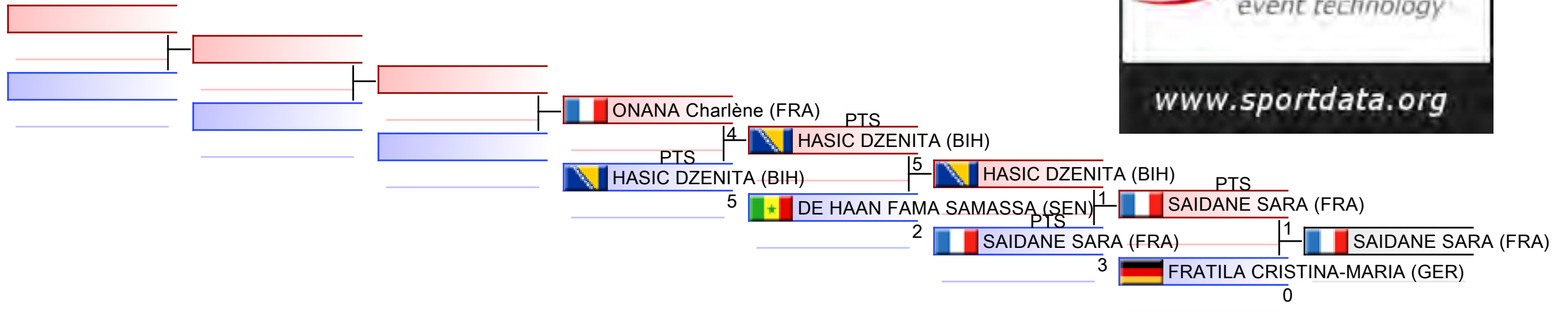

REPECHAGE: (4,1,2,3)

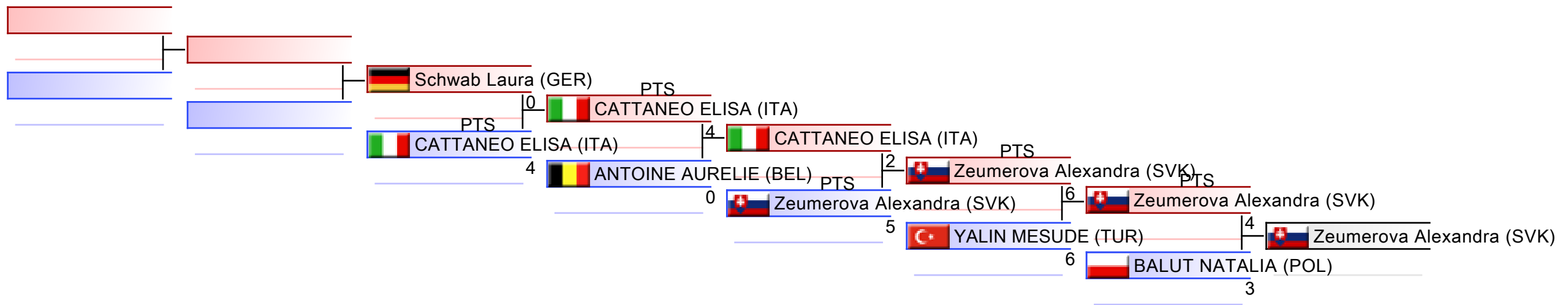



Karate1 Youth League - Venice 2024 - 2024-12-04



Official Results

Junior Kumite Female -66 kg (Entries: 83 Nations: 30)			
1	PAYROT CHLOE		FRA - FRANCE
2	NOURI SARINA		IRI - ISLAMIC REPUBLIC OF IRAN
3	SAIDANE SARA		FRA - FRANCE
3	ZEUMEROVA ALEXANDRA		SVK - SLOVAKIA
5	FRATILA CRISTINA-MARIA		GER - GERMANY
5	BALUT NATALIA		POL - POLAND
7	HASIC DZENITA		BIH - BOSNIA AND HERZEGOVINA
7	YALIN MESUDE		TUR - TURKIYE
9	DE HAAN FAMA SAMASSA		SEN - SENEGAL
9	CATTANEO ELISA		ITA - ITALY
11	ONANA CHARLÈNE		FRA - FRANCE
11	ANTOINE AURELIE		BEL - BELGIUM
13	SCHWAB LAURA		GER - GERMANY

JUNIOR KUMITE FEMALE 66+ KG



Karate1 Youth League - Venice 2024

ENTRIES BY WEIGHT CATEGORY



Junior Kumite Female 66+ kg

As of 8 DEC 2024

Country Code	ID	Gender	Name	Seeding
AIN-1		F	TEBRYAEVA YANA	
AZE	AZE003417	F	MAHARRAMLI DANIZ	
BIH		F	Čurić Berina	
BIH		F	RUDALIJA ŠILA	
BIH		F	Selman Ajra	
BIH		F	Topić Kaja	
CRO	CRO2841	F	TOMIC SARA	
CZE	CZE02248	F	HAKOVA AMALIE	
DEN	DEN02466	F	Bath Astamaja	
DEN		F	Yigit Azra	
ENG	ENG02912	F	Fry Autumn	
ENG		F	Leech Freya	
ENG	ENG101432	F	Noel Leilani	
ESP		F	Balbontin Sanz Paula	
ESP		F	Balbontin Sanz Sandra	
ESP		F	COLLADO SANTANO ALBA	
ESP		F	NASARRE SÁNCHEZ IRENE	
ESP		F	RAMIREZ GRANDE ERIKA	
ESP		F	RUIZ DELGADO SILVIA M ^a	
FIN	FIN02368	F	Kirov Vanessa	
FRA		F	ABID LINA	
FRA		F	Labas Asya	
FRA		F	RIGEADE Laura Moon	
FRA		F	viana margaux	
GER	GER03808	F	DAWOUD DALIA	
GRE	GRE03611	F	ANDREOU ANDRIANI	
HUN	HUN02490	F	Kopfer Anna	
HUN		F	Nagypál Ibolya	
ITA		F	Apuzzo Aurora	
ITA		F	BOCCHIOLA NOEMI	
ITA		F	Cimone Arianna	
ITA		F	De Vivo Ermelinda	
ITA		F	Gracco Morena	
ITA		F	Montebello Carlotta	
ITA	SD51898	F	PALUMBO VITTORIA PIA	
ITA		F	REBECCA ALBORINO	
ITA		F	TIRABOSCHI LETIZIA	
ITA		F	vannini emma	
KOR	KOR02353	F	KWUN HYEWON	
NCL		F	AMATSOKERMI Kenza	
NED	NED02697	F	Zwanenburg Robin	
POL	POL04919	F	Jedrzejewska Amelia	
POL	POL3975	F	SZYMANSKA WIKTORIA	
POR	POR02761	F	Rodrigues Angelina	
ROU	ROU03337	F	ANGHEL BIANCA	



Karate1 Youth League - Venice 2024
ENTRIES BY WEIGHT CATEGORY



Junior Kumite Female 66+ kg
As of 8 DEC 2024

Country Code	ID	Gender	Name	Seeding
ROU	ROU03708	F	DRAGAN DIANA	
SVK		F	Rumanovska Zoe	
SWE	SWE003123	F	WAHLSTROM MEJA	
SYR		F	Kashash Nour	
UKR	UKR02864	F	Bulay Dariia	

Junior Kumite Female 66+ kg

Karate1 Youth League - Venice 2024, PALAZZO DEL TURISMO, Piazza Brescia 11, 30016 Lido di Jesolo VE, ITA

2024-12-05

Tatami

5 17:55

Pool

1/4

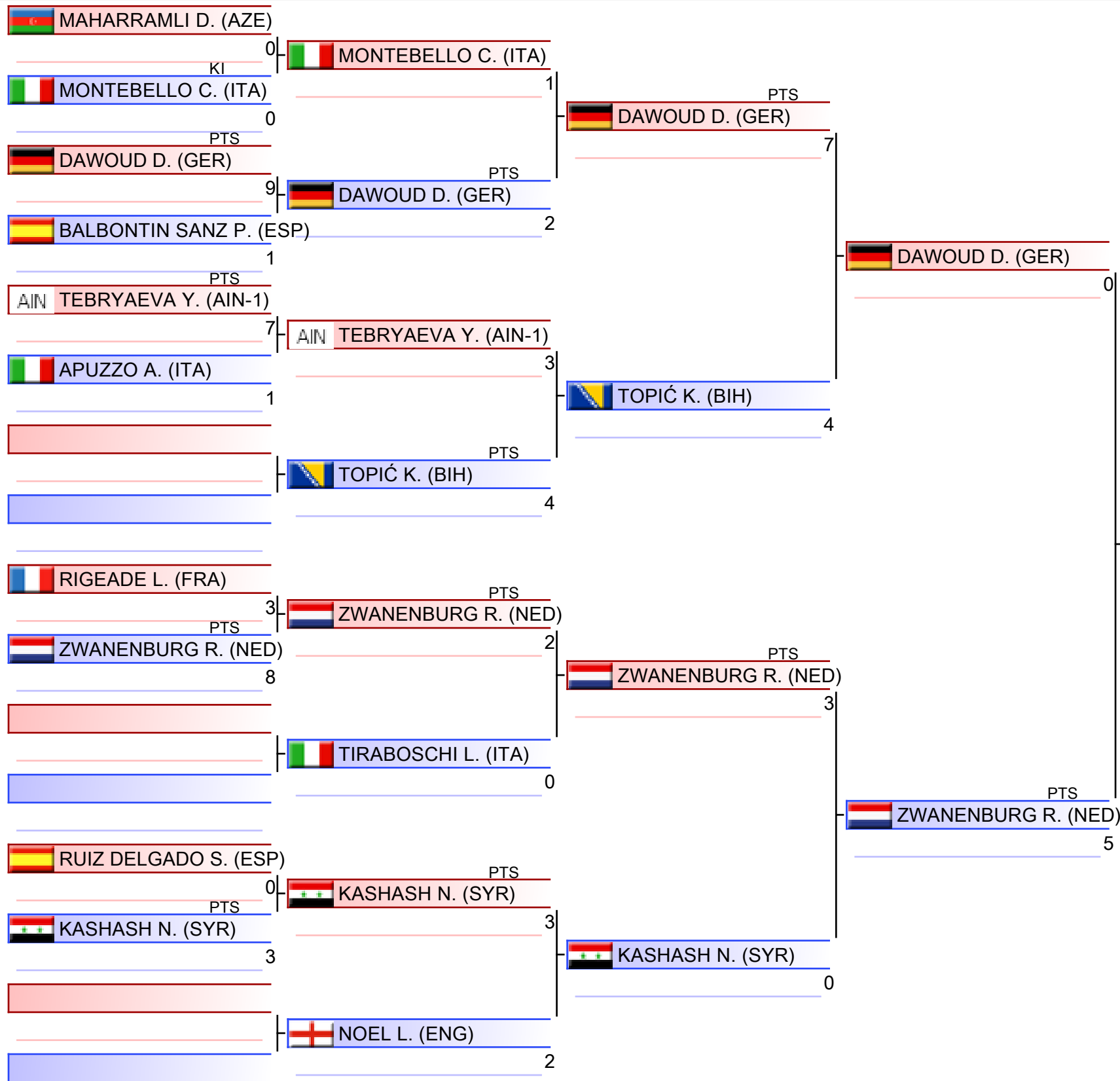

1. ZWANENBURG ROBIN (NED)
2. TOMIC SARA (CRO)
3. DAWOUD DALIA (GER)
3. HAKOVA AMALIE (CZE)
5. NASARRE SÁNCHEZ IRENE (ESP)
5. FRY AUTUMN (ENG)
7. RIGEADE LAURA MOON (FRA)
7. KIROV VANESSA (FIN)

Junior Kumite Female 66+ kg

Karate1 Youth League - Venice 2024, PALAZZO DEL TURISMO, Piazza Brescia 11, 30016 Lido di Jesolo VE, ITA

2024-12-05

Tatami
6 17:55

Pool
2/4

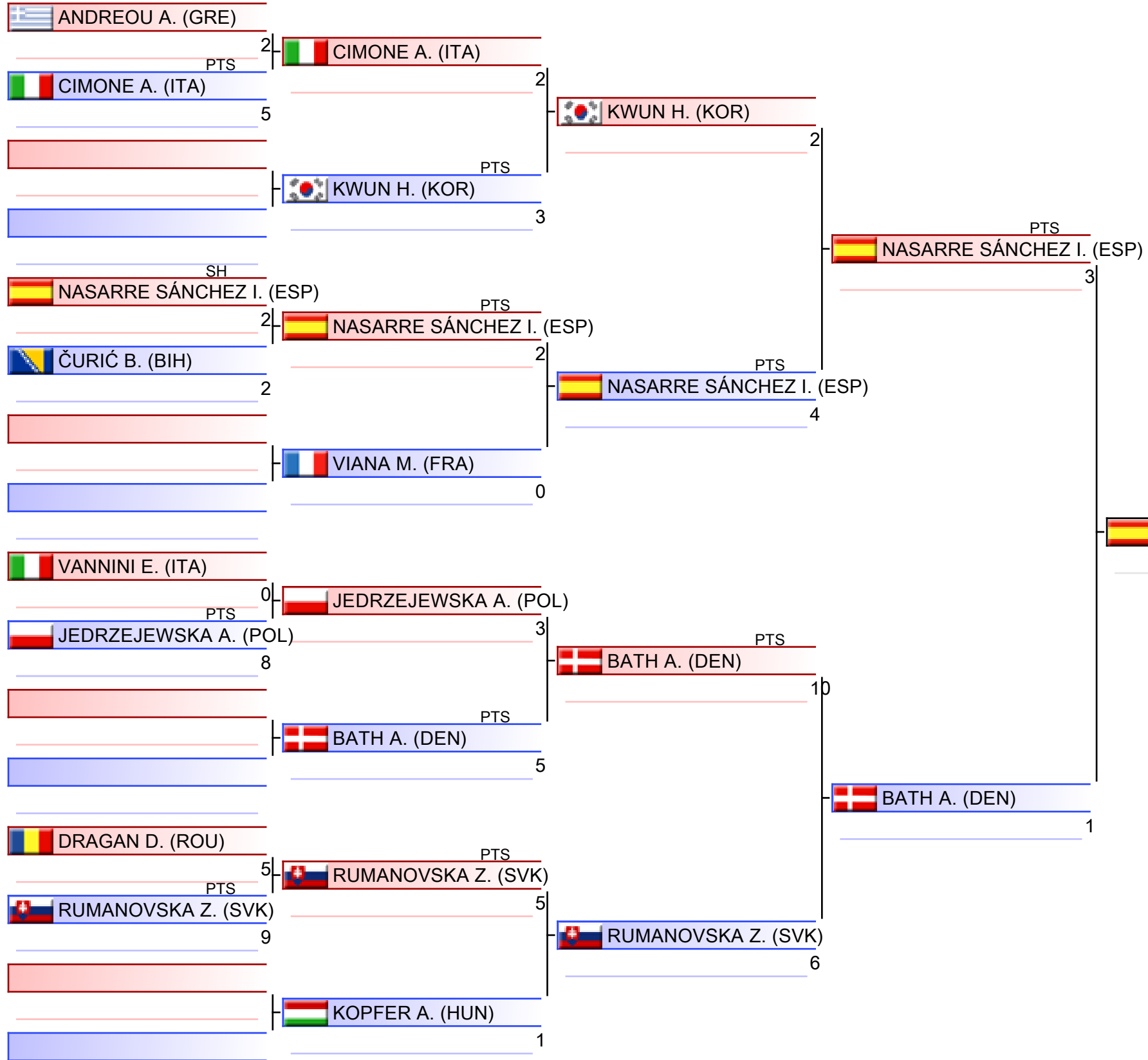

1. ZWANENBURG ROBIN (NED)
2. TOMIC SARA (CRO)
3. DAWOUD DALIA (GER)
3. HAKOVA AMALIE (CZE)
5. NASARRE SÁNCHEZ IRENE (ESP)
5. FRY AUTUMN (ENG)
7. RIGEADE LAURA MOON (FRA)
7. KIROV VANESSA (FIN)

Junior Kumite Female 66+ kg

Karate1 Youth League - Venice 2024, PALAZZO DEL TURISMO, Piazza Brescia 11, 30016 Lido di Jesolo VE, ITA

2024-12-05

Tatami

7 17:55

Pool

3/4

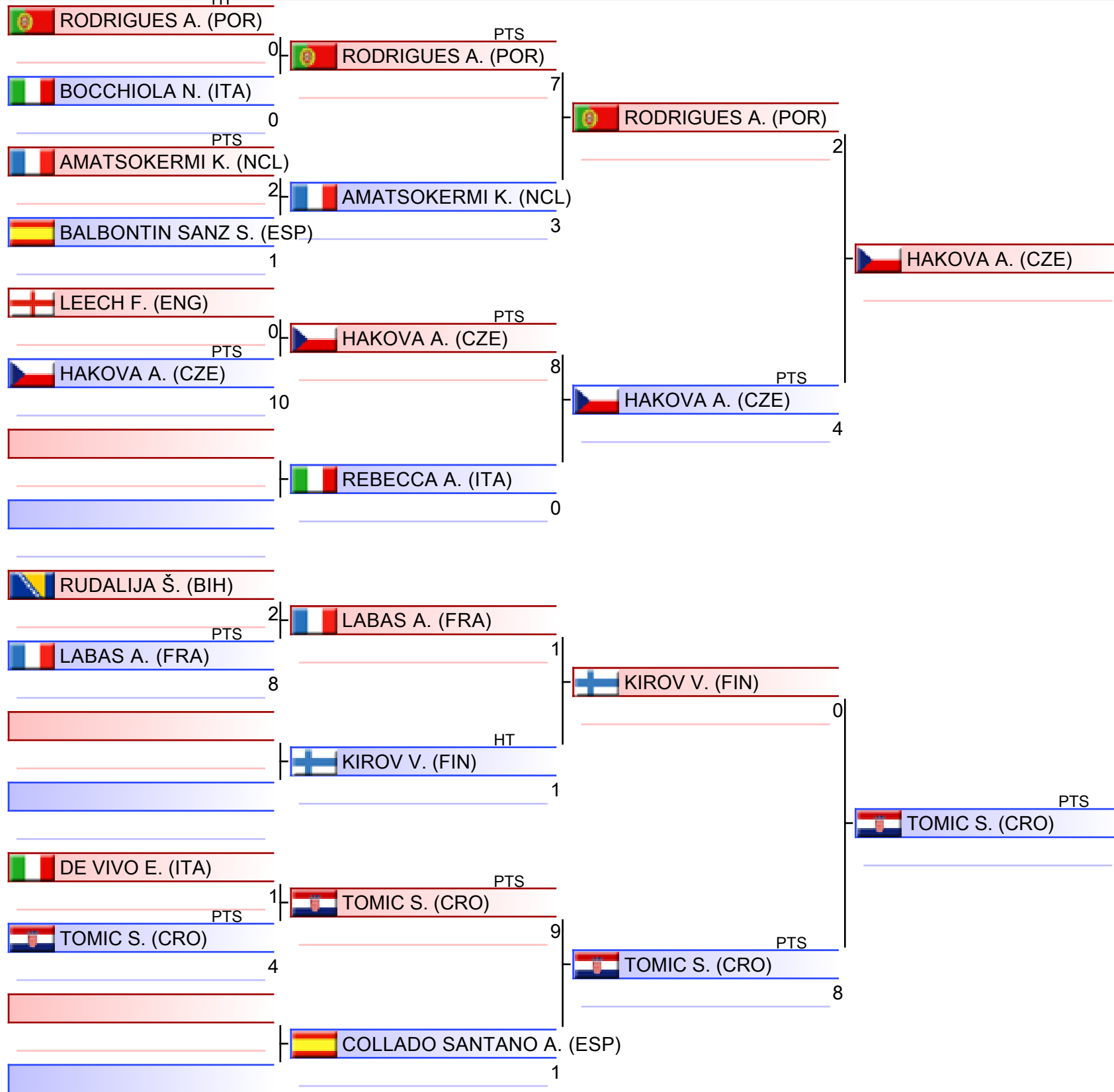

1. ZWANENBURG ROBIN (NED)
2. TOMIC SARA (CRO)
3. DAWOUD DALIA (GER)
3. HAKOVA AMALIE (CZE)
5. NASARRE SÁNCHEZ IRENE (ESP)
5. FRY AUTUMN (ENG)
7. RIGEADE LAURA MOON (FRA)
7. KIROV VANESSA (FIN)

Junior Kumite Female 66+ kg

Karate1 Youth League - Venice 2024, PALAZZO DEL TURISMO, Piazza Brescia 11, 30016 Lido di Jesolo VE, ITA

2024-12-05

Tatami

8 17:55

Pool

4/4

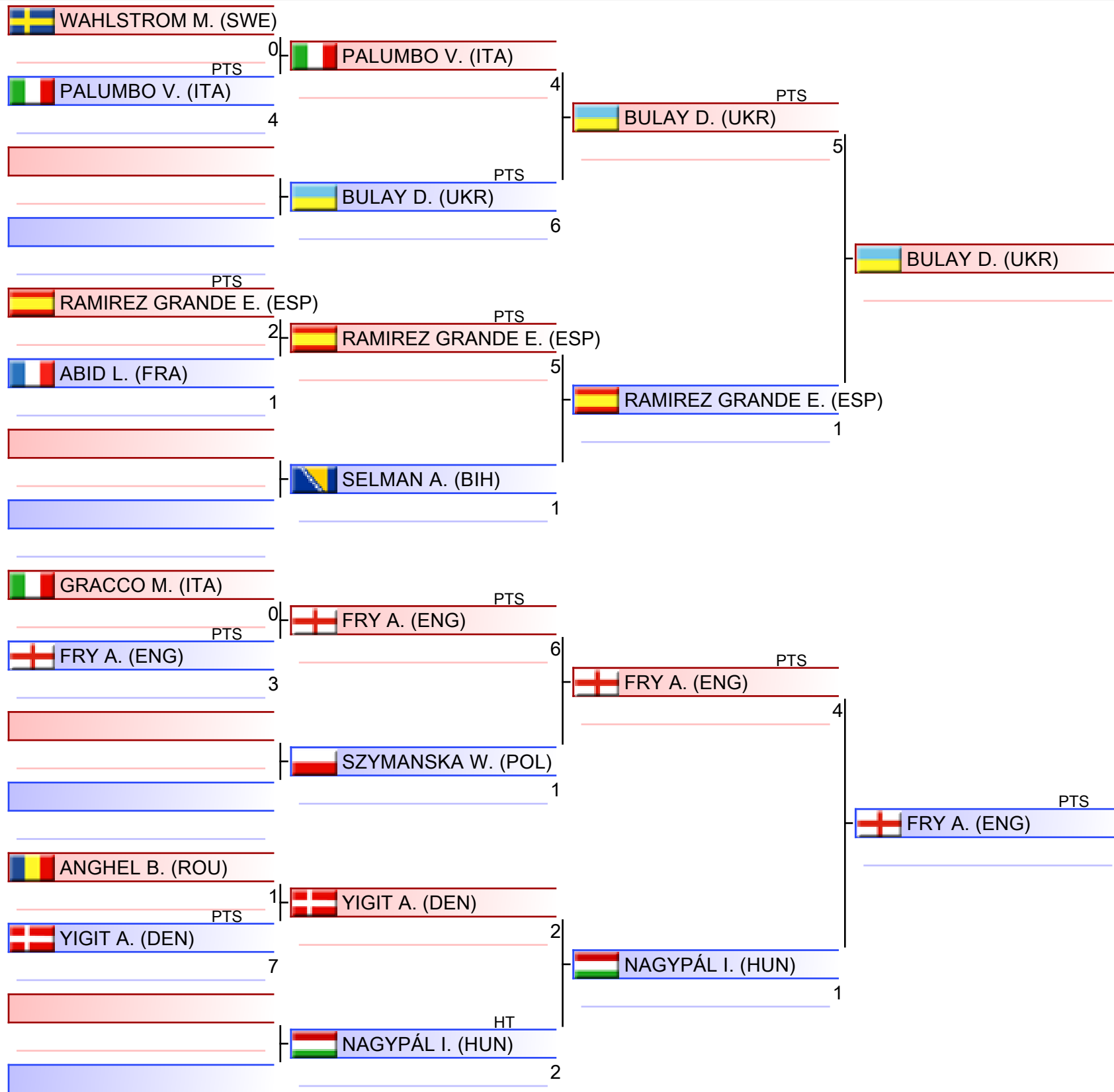

1.	ZWANENBURG ROBIN (NED)
2.	TOMIC SARA (CRO)
3.	DAWOUD DALIA (GER)
3.	HAKOVA AMALIE (CZE)
5.	NASARRE SÁNCHEZ IRENE (ESP)
5.	FRY AUTUMN (ENG)
7.	RIGEADE LAURA MOON (FRA)
7.	KIROV VANESSA (FIN)

Pool winner-Junior Kumite Female 66+ kg

Karate1 Youth League - Venice 2024, PALAZZO DEL TURISMO, Piazza Brescia 11, 30016 Lido di Jesolo VE, ITA

2024-12-05

Tatami
5 19:00

Pool
1/1

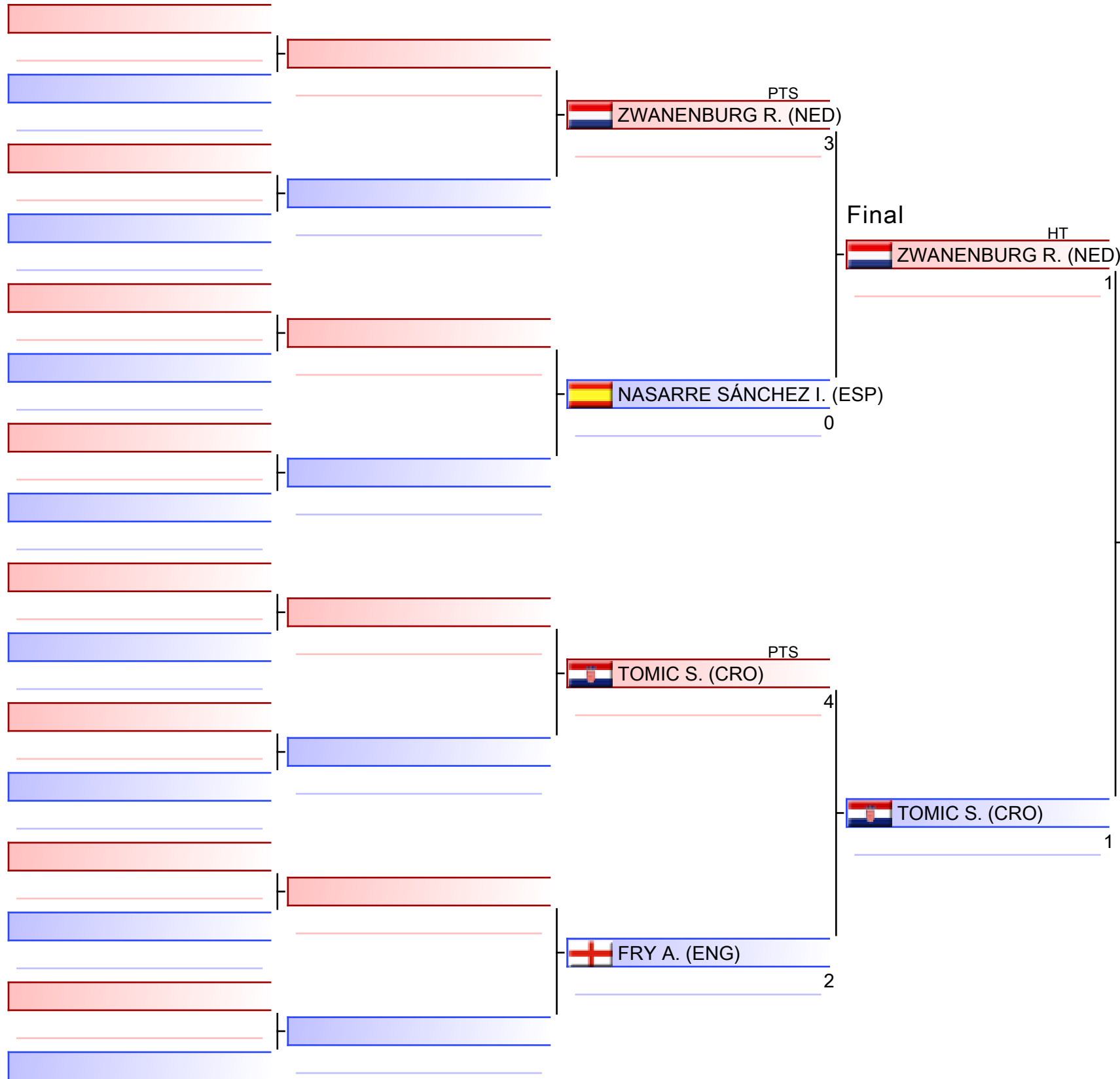

1. ZWANENBURG ROBIN (NED)
2. TOMIC SARA (CRO)
3. DAWOUD DALIA (GER)
3. HAKOVA AMALIE (CZE)
5. NASARRE SÁNCHEZ IRENE (ESP)
5. FRY AUTUMN (ENG)
7. RIGEADE LAURA MOON (FRA)
7. KIROV VANESSA (FIN)

Junior Kumite Female 66+ kg

Karate1 Youth League - Venice 2024

2024-12-05

Tatami
4 19:10

Pool
1,2,3,4

(c)sportdata GmbH & Co KG 2000-2024 (2024-12-08 20:16) v 10.2.0 build 1 (2024-11-20 00:58 CET) License: SDIL TVG (expire 2025-01-26)

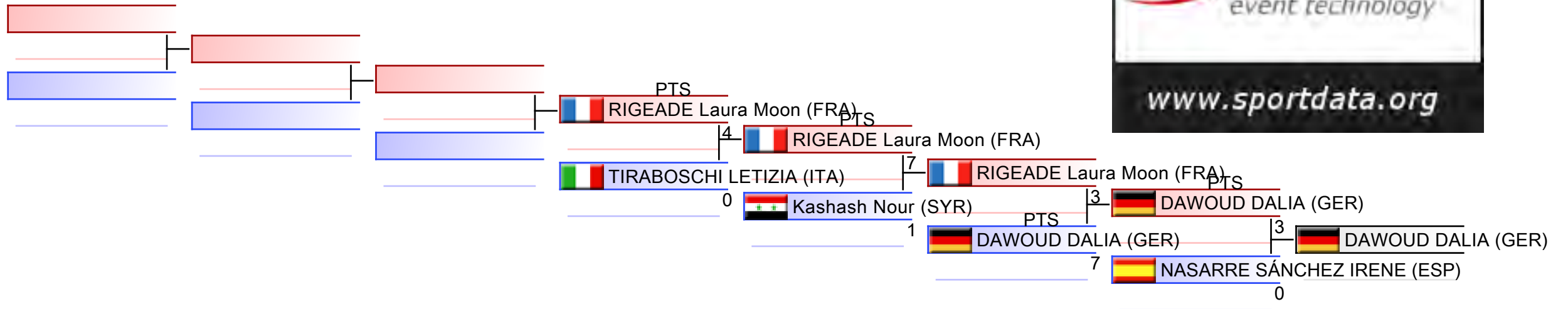

REPECHAGE: (1,2,3,4)

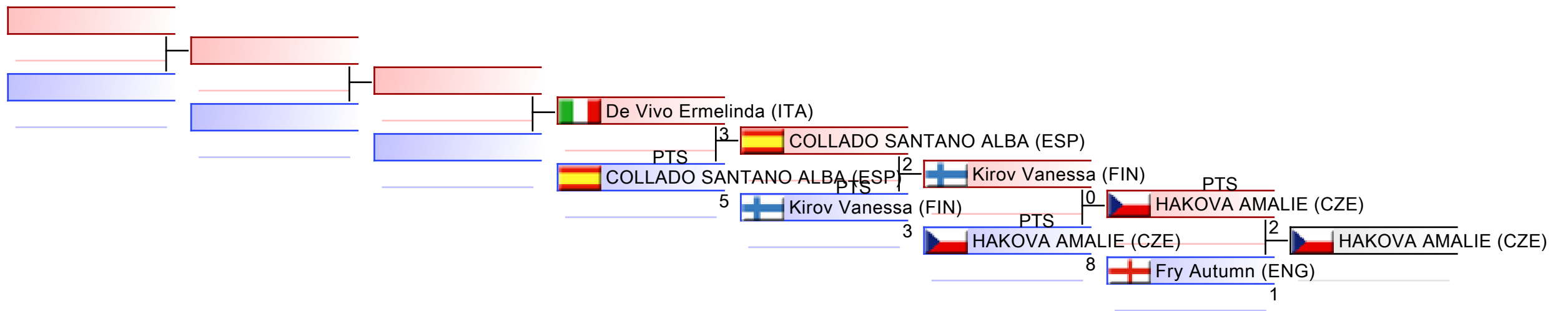



Karate1 Youth League - Venice 2024 - 2024-12-04



Official Results

Junior Kumite Female 66+ kg (Entries: 50 Nations: 24)			
1	ZWANENBURG ROBIN		NED - NETHERLANDS
2	TOMIC SARA		CRO - CROATIA
3	DAWOUD DALIA		GER - GERMANY
3	HAKOVA AMALIE		CZE - CZECH REPUBLIC
5	NASARRE SÁNCHEZ IRENE		ESP - SPAIN
5	FRY AUTUMN		ENG - ENGLAND
7	RIGEADE LAURA MOON		FRA - FRANCE
7	KIROV VANESSA		FIN - FINLAND
9	KASHASH NOUR		SYR - SYRIAN ARAB REPUBLIC
9	COLLADO SANTANO ALBA		ESP - SPAIN
11	TIRABOSCHI LETIZIA		ITA - ITALY
11	DE VIVO ERMELINDA		ITA - ITALY

JUNIOR KUMITE MALE -55 KG



Karate1 Youth League - Venice 2024

ENTRIES BY WEIGHT CATEGORY



Junior Kumite Male -55 kg

As of 8 DEC 2024

Country Code	ID	Gender	Name	Seeding
ARM	ARM02709	M	GEVORGYAN ALEN	
ARM	ARM003062	M	HAKOBYAN GEVORG	
AZE	AZE003404	M	AGIL RZAYEV	
BEL		M	Abdelmalki Youssef	
BEL	BEL02532	M	ALVES TORCATO MATHIS	
BIH		M	Aljović Sani	
BIH		M	Mitric Mihajlo	
BIH		M	Vejo Seldin	
BIH		M	ĐIDIĆ ISMAIL	
BIH		M	ĐIDIĆ VEDAD	
BRA		M	de Oliveira Eduardo	
CRO	CRO03500	M	JAKOVLJEVIC DINO	
CZE	CZE02420	M	HORNAK FILIP	
ENG	ENG02768	M	Baloch Leo	
ESP	ESP56636	M	FERNANDEZ GONZALEZ SERGIO	
ESP		M	PEREZ LORITE JORGE	
ESP		M	Quinto Gomez Jesus	
FRA		M	Ben fraj Idris	
FRA		M	Bucher Yanis	
FRA		M	dahmani ayoub	
FRA	FRA03452	M	NOUI Zakariya	
GER	GER03862	M	ALTKEMPER SAM	
GRE	GRE02758	M	PAPADOPOULOS DIMOSTHENIS	
HUN		M	Hecker Armin	
HUN		M	Osváth Ákos Ferenc	
IRL	IRL02843	M	PHELAN SEAN	
ITA		M	ALLEGRETTA SIMONE	
ITA		M	Busi Lorenzo	
ITA		M	CELENTANO ANTONIO	
ITA		M	DE PASQUALE MICHELE	
ITA		M	Duca Leonardo	
ITA	ITA04200	M	FOSCHI SEBASTIAN	
ITA		M	GIULIANO MATTEO	
ITA	ITA04554	M	Golinelli Federico	
ITA		M	Guarino Andrea	
ITA		M	MOINI FILIPPO	
ITA		M	MONDO BRANCHI MATTEO	
ITA		M	Paoletti Niccolò	
ITA		M	Spilinga Cristian	
KUW	KUW02398	M	ALAJMI ABDALHADI	
KUW	KUW003016	M	ALAZMI SAAD	
KUW		M	Almutairi Eissa	
LAT	LAT02515	M	Balzaris Miroslavs	
LAT		M	Galuzo Dmitrijs	
LAT		M	Holodovs Viktors	



Karate1 Youth League - Venice 2024

ENTRIES BY WEIGHT CATEGORY



Junior Kumite Male -55 kg

As of 8 DEC 2024

Country Code	ID	Gender	Name	Seeding
MDA	MDA002522	M	TERZI DAVID	
MKD		M	Abazi Aldin	
NED	NED02732	M	To Nicolas	
POL	POL3233	M	CYMANOWSKI JAN	
POL	POL2955	M	OLICHWER NATAN	
POL	POL2694	M	WOJCIECHOWSKI KACPER	
POR		M	Fernandes Santiago Pinéu	
POR		M	Ferreira Guilherme	
ROU	ROU003965	M	ERIK CHRISTIAN ANDREI	
ROU	ROU03765	M	TANASE ANDREI	
SCO		M	Reynolds Sonny	
SRB		M	Aničić Luka	
SRB		M	Djurdjić Marko	
SVK		M	Cséfalvay Pavol	
SVK		M	Cséfalvay Peter	
TKM	TKM02133	M	OVEZMYRADOV JORA	
TKM	TKM002696	M	SULEYMANOV RAHYM	
TUR		M	BAYIR BATUHAN	
TUR		M	Usta Arda	
UKR		M	AVILOV ARTEM	
UKR		M	KULCHYTSKYI VLADYSLAV	
UKR		M	KVAS ANDRII	
UKR		M	Nikulcha Yurii	
UKR	UKR02869	M	RUDENKO ARSENII	
UKR		M	Sheremet Dmytro	
UKR		M	Sokha Nazar	
USA	USA02996	M	Ochoa Ken	
VEN		M	Milla Berti Alfonso David	
VEN		M	Sulbaran González Jesus Daniel	

Junior Kumite Male -55 kg

Karate1 Youth League - Venice 2024, PALAZZO DEL TURISMO, Piazza Brescia 11, 30016 Lido di Jesolo VE, ITA

2024-12-06

Tatami
1 13:55

Pool
1/4

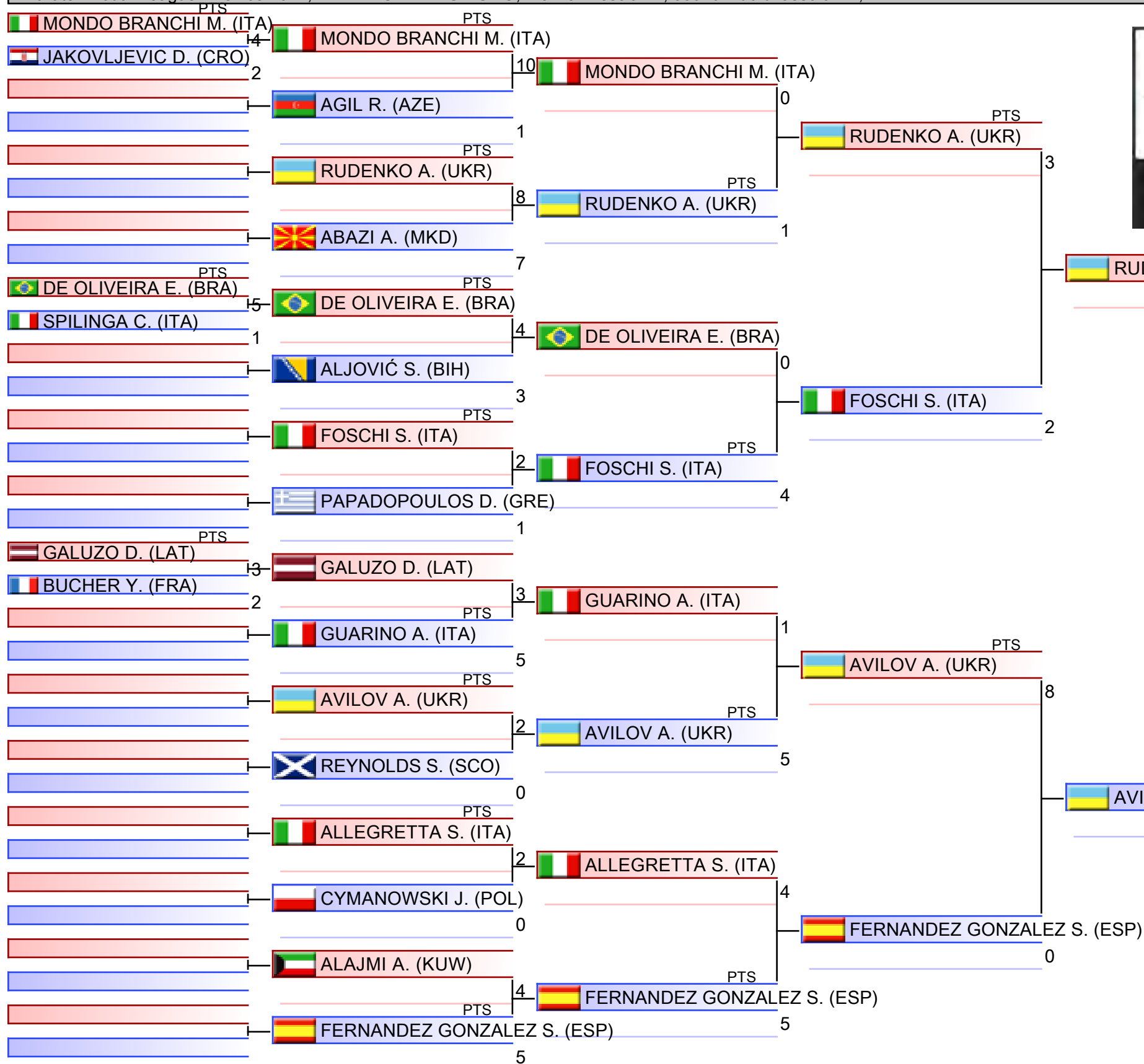

1. CELENTANO ANTONIO (ITA)
2. RUDENKO ARSENI (UKR)
3. FOSCHI SEBASTIAN (ITA)
3. GEVORGYAN ALEN (ARM)
5. DAHMANI AYOUB (FRA)
5. HORNAK FILIP (CZE)
7. AVILOV ARTEM (UKR)
7. WOJCIECHOWSKI KACPER (POL)

Junior Kumite Male -55 kg

Karate1 Youth League - Venice 2024, PALAZZO DEL TURISMO, Piazza Brescia 11, 30016 Lido di Jesolo VE, ITA

2024-12-06

Tatami
2 13:55

Pool
2/4

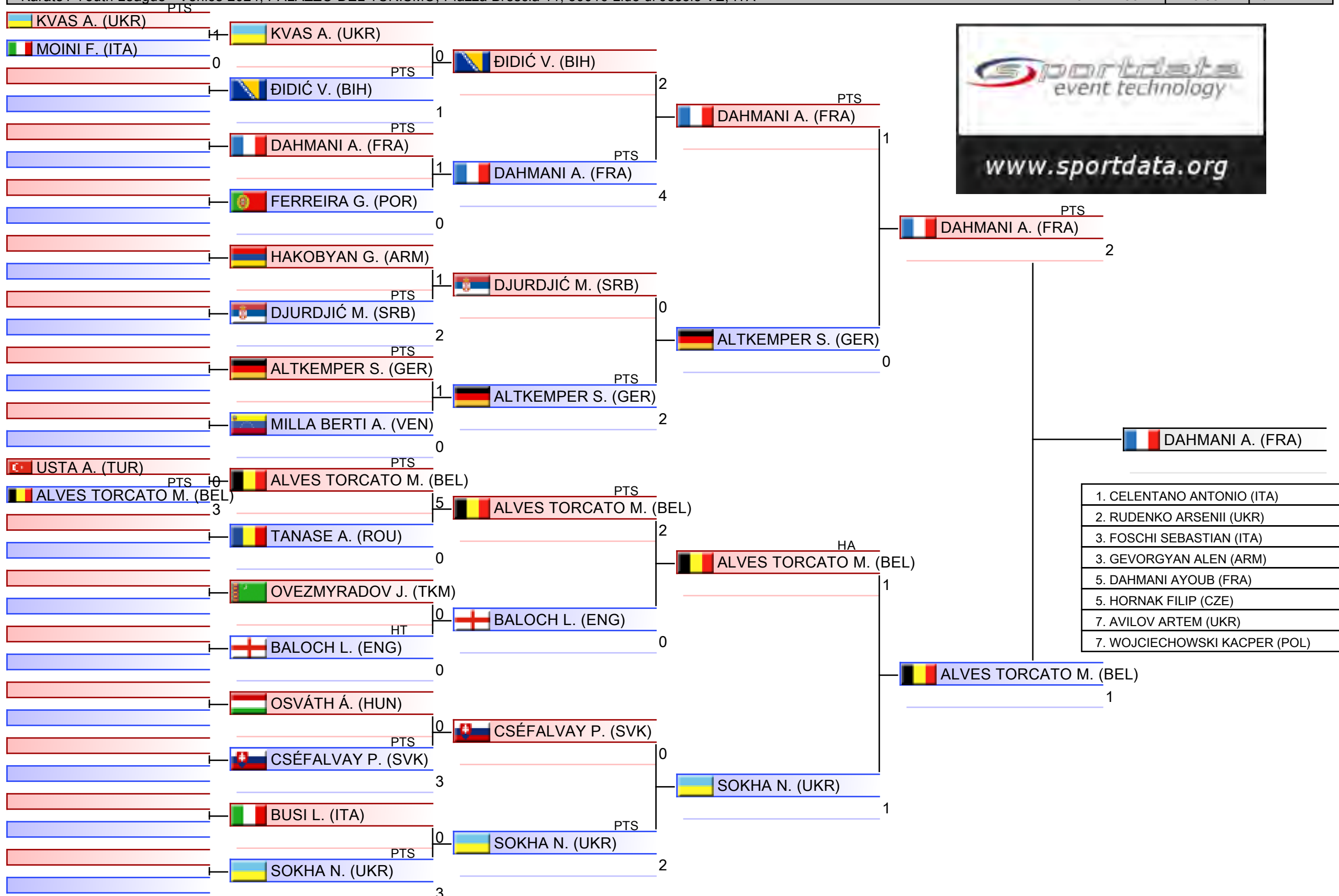

Junior Kumite Male -55 kg

Karate1 Youth League - Venice 2024, PALAZZO DEL TURISMO, Piazza Brescia 11, 30016 Lido di Jesolo VE, ITA

2024-12-06

Tatami
3 13:55

Pool
3/4

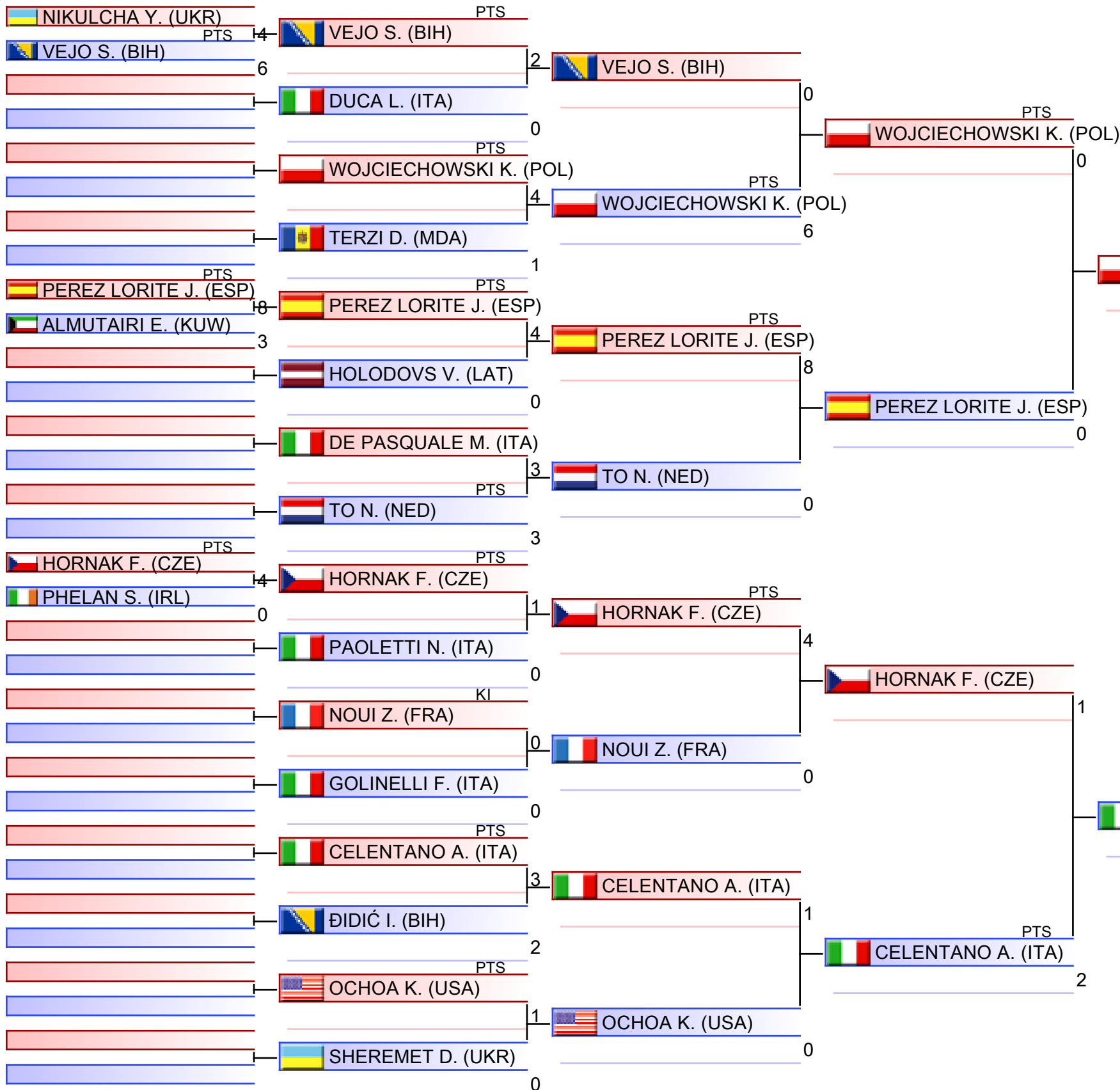

1.	CELENTANO ANTONIO (ITA)
2.	RUDENKO ARSENI (UKR)
3.	FOSCHI SEBASTIAN (ITA)
3.	GEVORGYAN ALEN (ARM)
5.	DAHMANI AYOUB (FRA)
5.	HORNAK FILIP (CZE)
7.	AVILOV ARTEM (UKR)
7.	WOJCIECHOWSKI KACPER (POL)

Junior Kumite Male -55 kg

Karate1 Youth League - Venice 2024, PALAZZO DEL TURISMO, Piazza Brescia 11, 30016 Lido di Jesolo VE, ITA

2024-12-06

Tatami
4 13:55

Pool
4/4

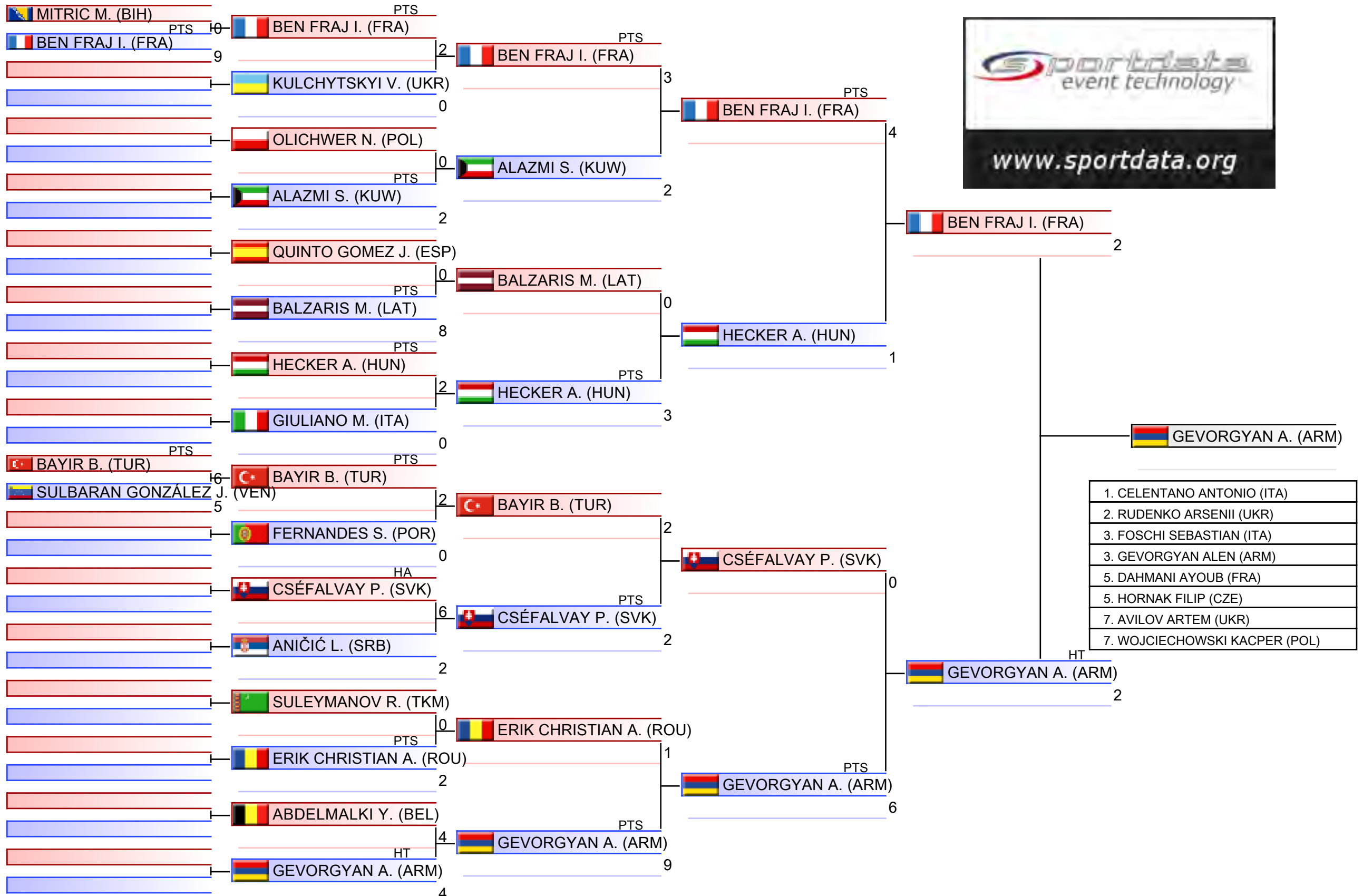

Pool winner-Junior Kumite Male -55 kg

Karate1 Youth League - Venice 2024, PALAZZO DEL TURISMO, Piazza Brescia 11, 30016 Lido di Jesolo VE, ITA

2024-12-06

Tatami
1 15:35

Pool
1/1

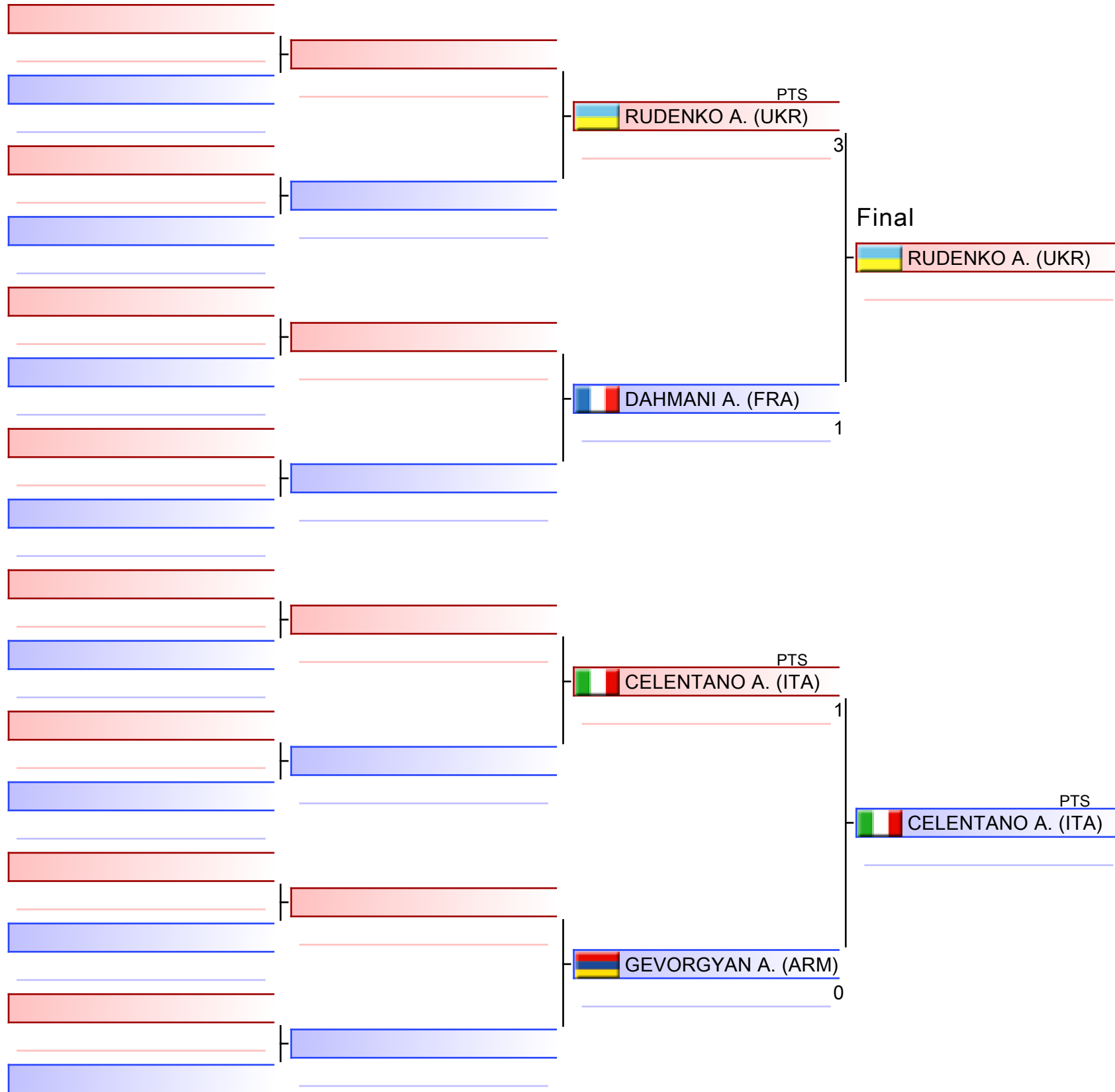

CELENTANO A. (ITA)

1. CELENTANO ANTONIO (ITA)
2. RUDENKO ARSENI (UKR)
3. FOSCHI SEBASTIAN (ITA)
3. GEVORGYAN ALEN (ARM)
5. DAHMANI AYOUB (FRA)
5. HORNAK FILIP (CZE)
7. AVILOV ARTEM (UKR)
7. WOJCIECHOWSKI KACPER (POL)

Junior Kumite Male -55 kg

Karate1 Youth League - Venice 2024

2024-12-06

Tatami

5 19:10

Pool

1,4,3,2

(c)sportdata GmbH & Co KG 2000-2024 (2024-12-08 20:16) v 10.2.0 build 1 (2024-11-20 00:58 CET) License: SDIL TVG (expire 2025-01-26)

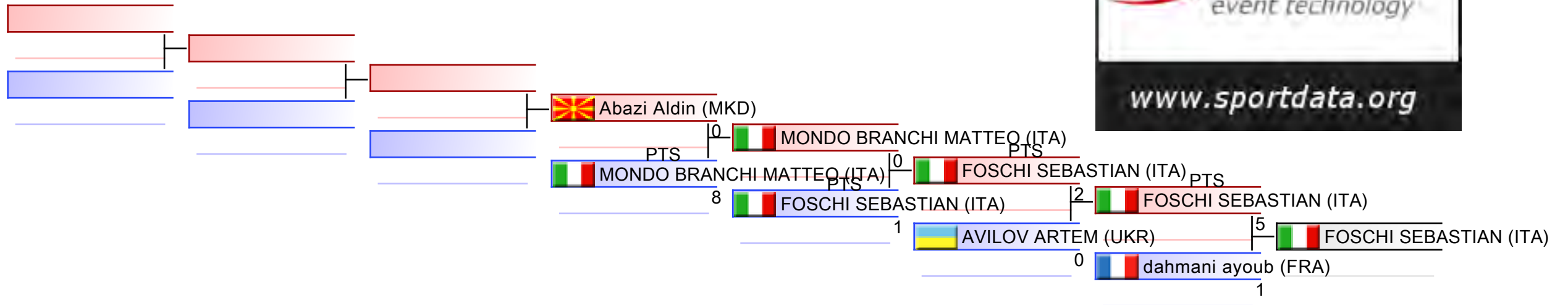

REPECHAGE: (1,4,3,2)

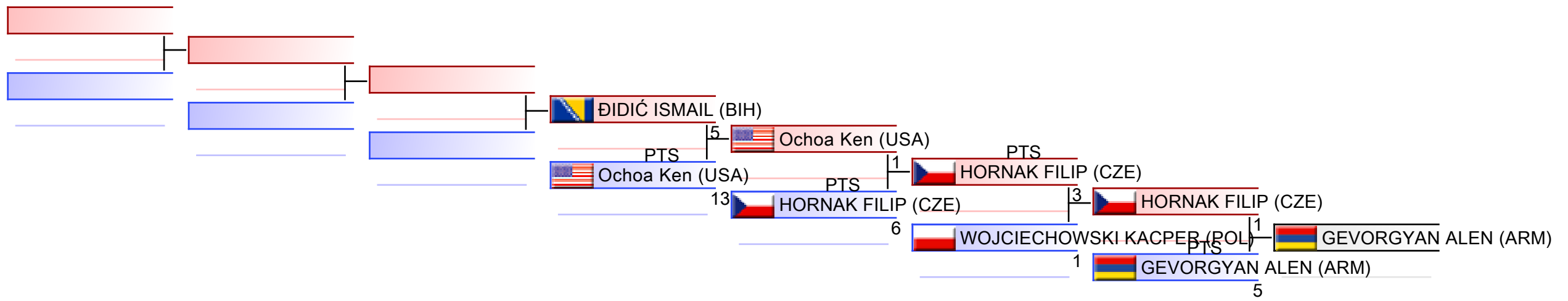



Karate1 Youth League - Venice 2024 - 2024-12-04



Official Results

Junior Kumite Male -55 kg (Entries: 74 Nations: 31)			
1	CELENTANO ANTONIO		ITA - ITALY
2	RUDENKO ARSENI		UKR - UKRAINE
3	FOSCHI SEBASTIAN		ITA - ITALY
3	GEVORGYAN ALEN		ARM - ARMENIA
5	DAHMANI AYOUB		FRA - FRANCE
5	HORNAK FILIP		CZE - CZECH REPUBLIC
7	AVILOV ARTEM		UKR - UKRAINE
7	WOJCIECHOWSKI KACPER		POL - POLAND
9	MONDO BRANCHI MATTEO		ITA - ITALY
9	OCHOA KEN		USA - UNITED STATES
11	ABAZI ALDIN		MKD - NORTH MACEDONIA
11	ĐIDIĆ ISMAIL		BIH - BOSNIA AND HERZEGOVINA

JUNIOR KUMITE MALE -61 KG



Karate1 Youth League - Venice 2024

ENTRIES BY WEIGHT CATEGORY



Junior Kumite Male -61 kg

As of 8 DEC 2024

Country Code	ID	Gender	Name	Seeding
ARM	ARM02967	M	GRIGORYAN SUREN	
AUT		M	Sakanovic Adin	
AUT		M	Wintersperger Lorenz	
BEL	BEL02535	M	ROMBEAUX MATT	
BEL		M	Triches Yann	
BIH		M	Bašić Kemal	
BIH	BIH03865	M	Halilovic Emir	
BIH		M	Mujić Vedad	
BIH		M	Neziric Fejsal	
CAN		M	MOULOU DJ ANIS	
CRO		M	Gavic Kristian	
CRO	CRO2811	M	MABIC FILIP	
CYP		M	LOIZOU GIANNIS	
CZE	CZE02265	M	BINA TADEAS	
CZE		M	Derfl Jan	
CZE	CZE02481	M	DUB DANIEL	
CZE	CZE02427	M	HARVILKO SIMON	
CZE	CZE02348	M	LINHART JOSEF	
ENG	ENG02770	M	Attard Zachary	
ENG		M	Bennett Malachi	
ENG		M	Chesterman William	
ENG		M	Paul Syon	
ENG	ENG02819	M	Tahov Valentin	
ENG		M	WATSTON KAI	
ESP		M	Benitez Espuela David	
ESP		M	Fontenlos Ferreiro Samuel	
ESP		M	Maestre Barreda Jose	
ESP		M	ORTEGA RUIZ SANTIAGO	
FRA	SD65553	M	Fournivale Jawel	
FRA		M	HASSAINE Salah	
FRA		M	ROCHER Erwan	
FRA		M	Sabri Medjid Davin	
GER		M	Bruno Gabriel	
GER	GER02762	M	Dahm William Miyamoto	
GER		M	Ehmke Jeremias	
GER	GER03357	M	SAFI HEIDAR	
GRE	GRE003926	M	NTINTEMPASVILI LEONIDAS	
HUN		M	Kovács Gergely Kristóf	
HUN	HUN02531	M	Tóth Máté Roland	
HUN		M	Turányi Mátyás	
ITA		M	Amarante Antonio	
ITA		M	BRANDI JACOPO	
ITA		M	CALIFANO EMANUELE	
ITA		M	Ciavarella Riccardo	
ITA		M	DAN CHRISTIAN RICCARDO	



Karate1 Youth League - Venice 2024

ENTRIES BY WEIGHT CATEGORY



Junior Kumite Male -61 kg

As of 8 DEC 2024

Country Code	ID	Gender	Name	Seeding
ITA		M	De Simone Paolo	
ITA	ITA04476	M	De Stefano Emanuele	
ITA	ITA04489	M	DI LEMME ALESSANDRO	
ITA		M	Di Maio Tommaso	
ITA		M	GENTA Jacopo	
ITA		M	Gentili Mathias	
ITA	ITA04556	M	GUERRA RICCARDO	
ITA		M	Guida Samuele	
ITA		M	MUSANTI ENEA	
ITA		M	Nasser Paolo	
ITA	ITA04407	M	Navarra Francesco	
ITA		M	Zanni Federico	
KOR	KOR002397	M	HA TAESEOK	
KOS	KOS03013	M	LATIFI TAULANT	
KOS	KOS003589	M	VOKSHI ANIL	
LUX	LUX02187	M	Coimbra Pol	
MAR	MAR02913	M	sadini samir	
NOR	NOR02484	M	Berg-Alstadsæter Peder Xinge	
POL	POL05899	M	Jibril Makiere	
POL	POL4047	M	MASZOTA FILIP	
POL	POL3946	M	MIELEWCZYK IGOR	
POL	POL3299	M	SOLTYS SZYMON	
POL	POL3943	M	WOJCIECHOWSKI KONRAD	
POR		M	Cidra Diogo	
POR	POR02804	M	Costa Afonso Lencart	
POR		M	Gonçalves João	
POR	POR02759	M	Mendinhos António	
ROU	ROU03589	M	GUTA PATRIK	
ROU	ROU02831	M	IANCU DAVID ADRIAN	
ROU	ROU2292	M	LUNGU LUCIAN	
ROU	ROU2446	M	NEAGU-BARZAN ALEXANDRE	
SLO	SLO02571	M	FILIPIC MARK	
SRB		M	Vučković Aleksandar	
SRB		M	Vukasinovic Marko	
SVK		M	Chrenko Jan	
SVK	SVK03132	M	Plichta Bruno	
SVK		M	Rešovský Daniel	
SWE	SWE02691	M	BECHTIOUI TAHA	
TKM	TKM002689	M	BAYRAMOV BAYRAMGELDI	
TUR	TUR03730	M	ASLAN Kagan	
TUR	TUR03707	M	OGUS SAVAS	
UKR		M	KOZAK TYMOFII	
UKR		M	Kozlovskiyi Artem	
UKR	UKR03066	M	Prannychuk Nazarii	
UKR		M	STANKOV SERHII	



Karate1 Youth League - Venice 2024

ENTRIES BY WEIGHT CATEGORY



Junior Kumite Male -61 kg

Karate1 Youth League - Venice 2024, PALAZZO DEL TURISMO, Piazza Brescia 11, 30016 Lido di Jesolo VE, ITA

2024-12-06

Tatami
5 12:40

Pool
1/4

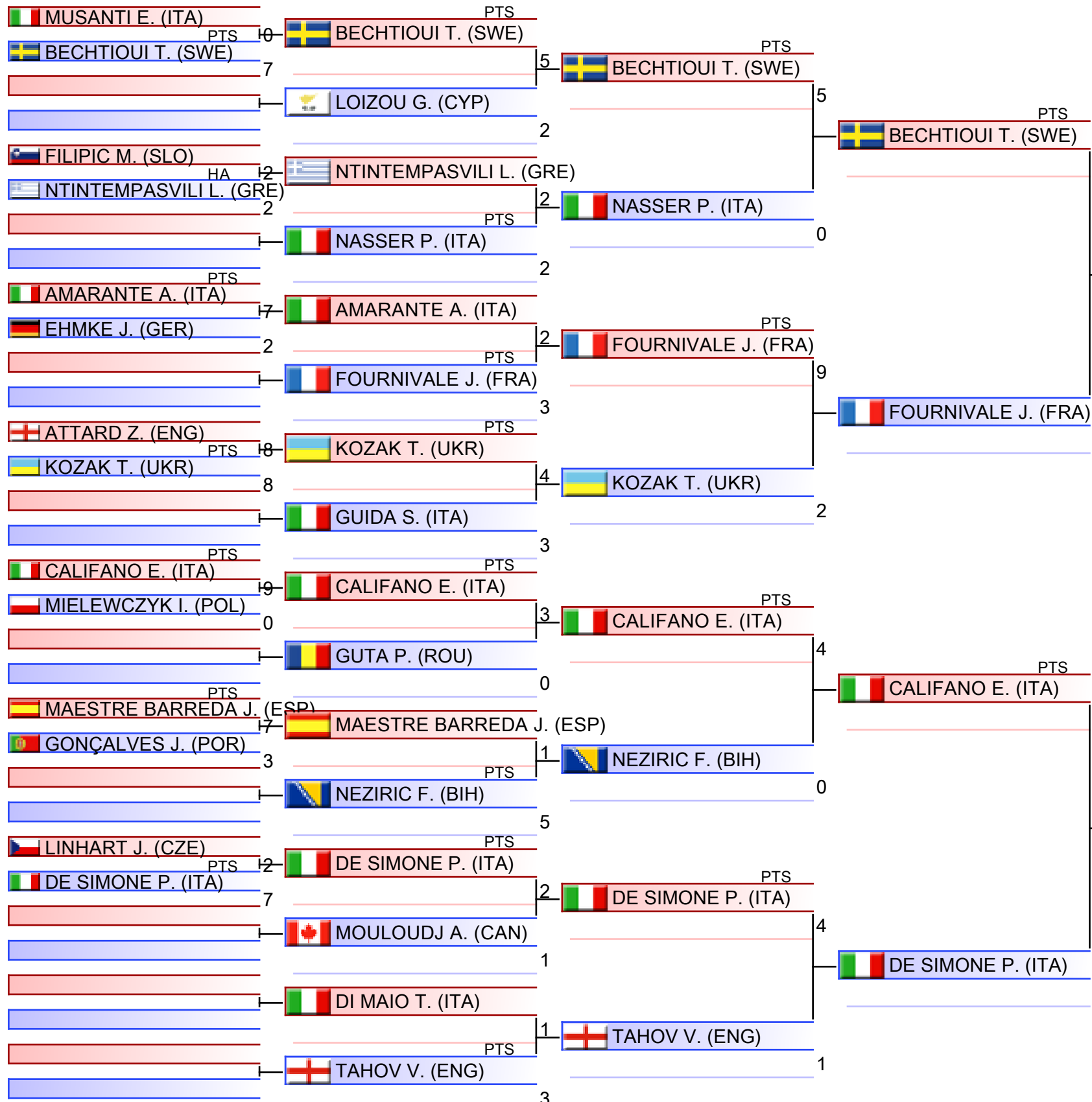

1. ROMBEAUX MATT (BEL)
2. TÓTH MÁTÉ ROLAND (HUN)
3. LUNGU LUCIAN (ROU)
3. OGUS SAVAS (TUR)
5. NEAGU-BARZAN ALEXANDRE (ROU)
5. CALIFANO EMANUELE (ITA)
7. MABIC FILIP (CRO)
7. PRANNYCHUK NAZARII (UKR)

Junior Kumite Male -61 kg

Karate1 Youth League - Venice 2024, PALAZZO DEL TURISMO, Piazza Brescia 11, 30016 Lido di Jesolo VE, ITA

2024-12-06

Tatami
6 12:40

Pool
2/4

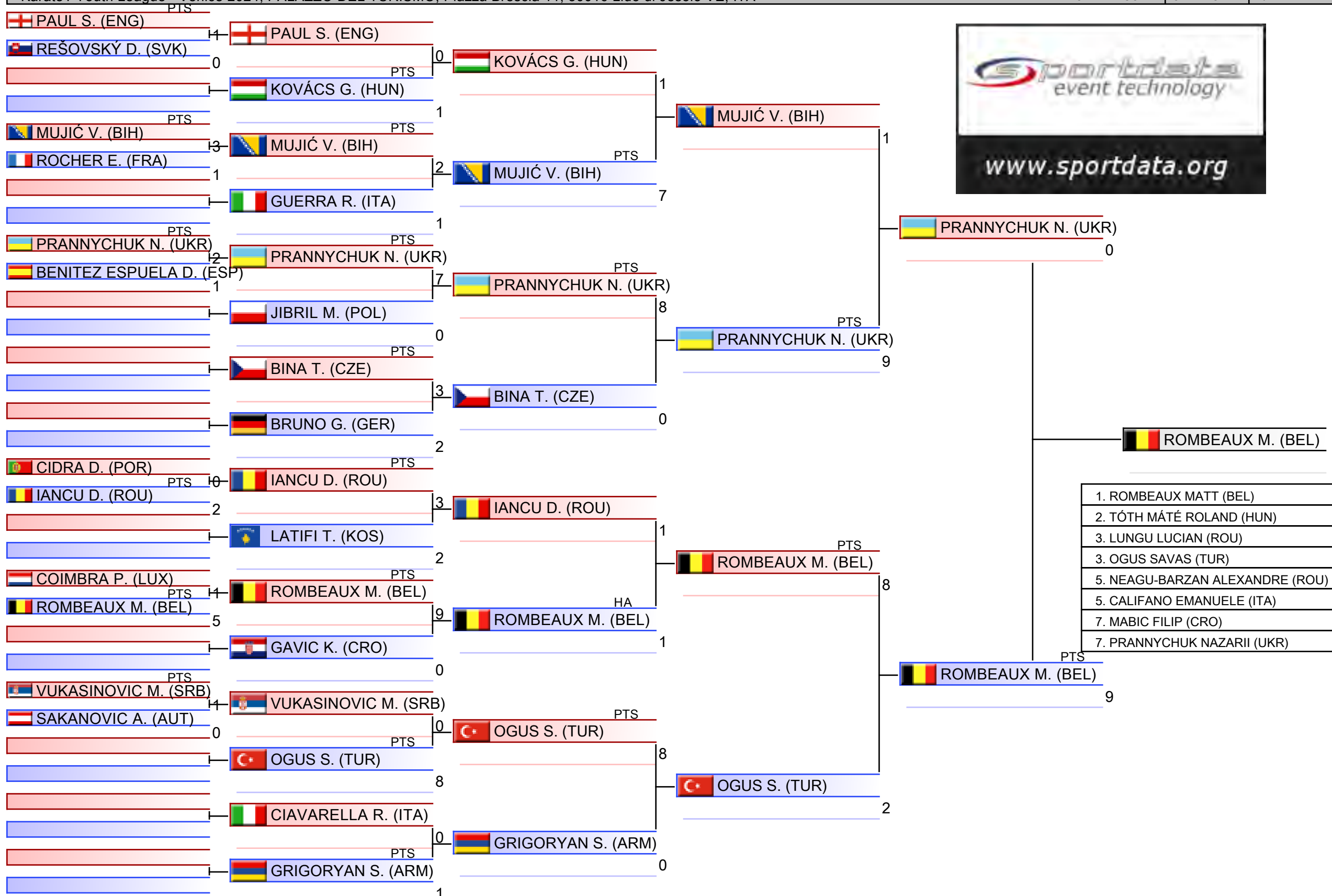

1. ROMBEAUX MATT (BEL)
2. TÓTH MÁTÉ ROLAND (HUN)
3. LUNGU LUCIAN (ROU)
3. OGUS SAVAS (TUR)
5. NEAGU-BARZAN ALEXANDRE (ROU)
5. CALIFANO EMANUELE (ITA)
7. MABIC FILIP (CRO)
7. PRANNYCHUK NAZARII (UKR)

Junior Kumite Male -61 kg

Karate1 Youth League - Venice 2024, PALAZZO DEL TURISMO, Piazza Brescia 11, 30016 Lido di Jesolo VE, ITA

2024-12-06

Tatami
7 12:40

Pool
3/4

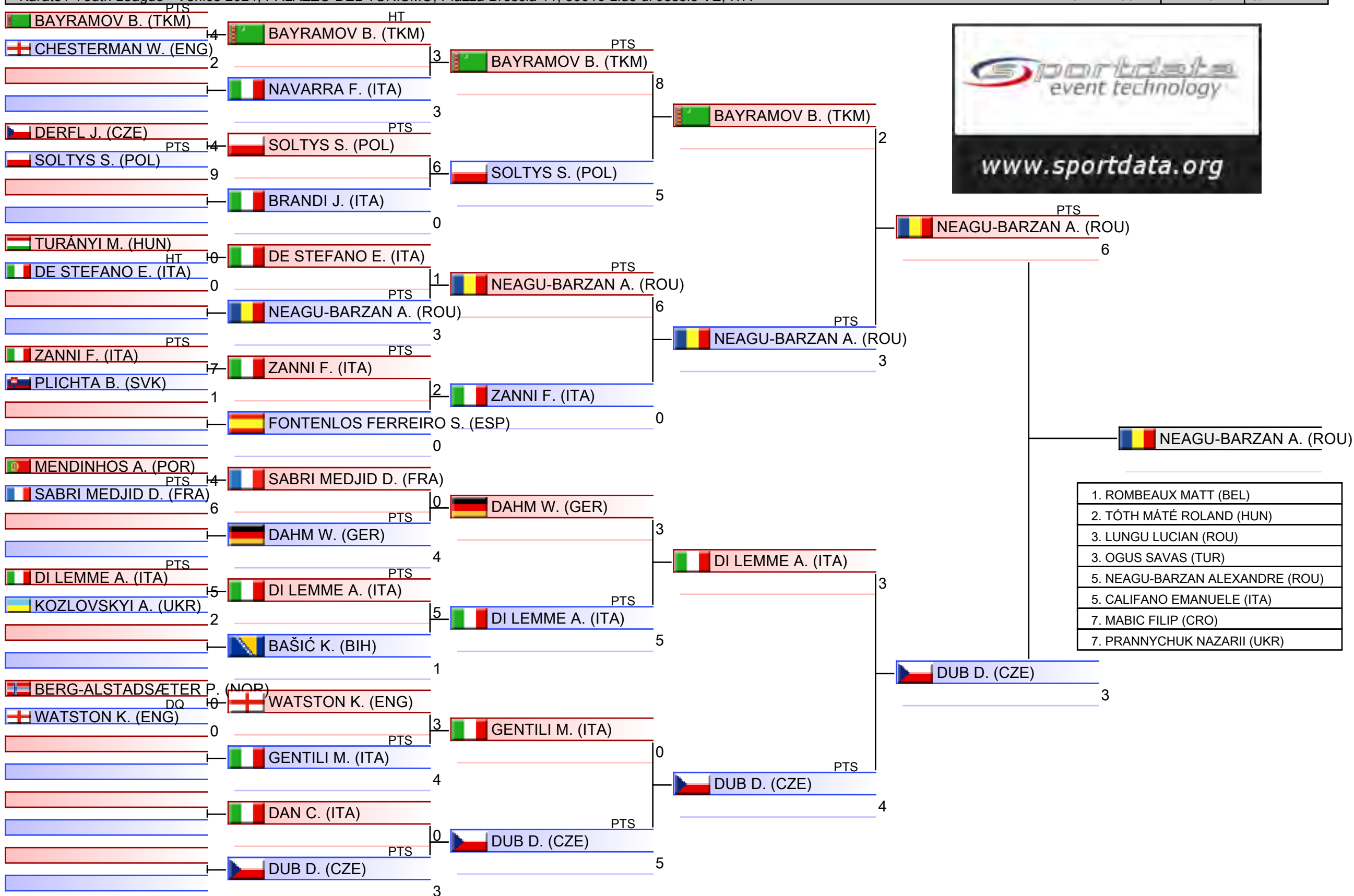

Junior Kumite Male -61 kg

Karate1 Youth League - Venice 2024, PALAZZO DEL TURISMO, Piazza Brescia 11, 30016 Lido di Jesolo VE, ITA

2024-12-06

Tatami
8 12:40

Pool
4/4

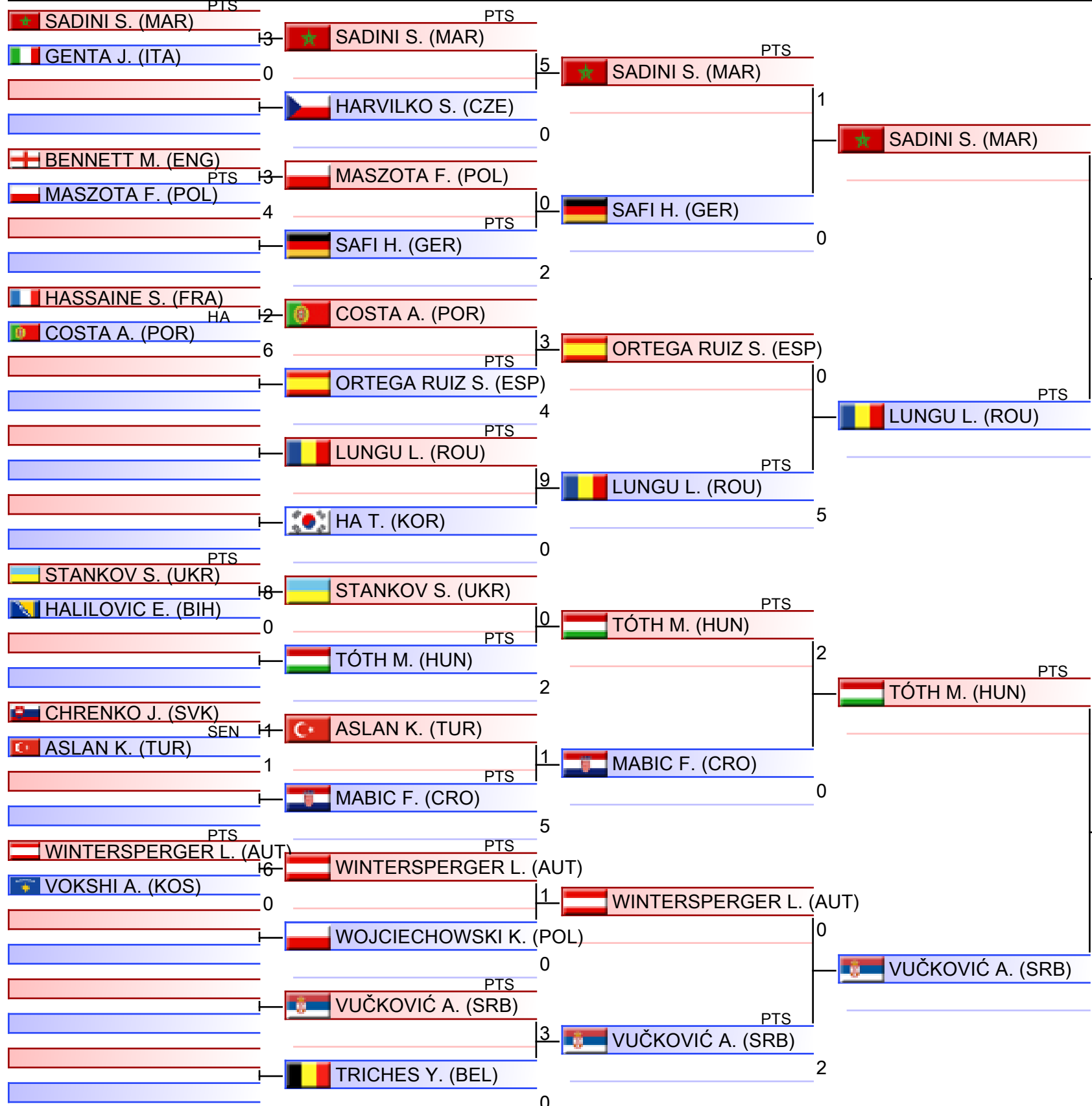

1. ROMBEAUX MATT (BEL)
2. TÓTH MÁTÉ ROLAND (HUN)
3. LUNGU LUCIAN (ROU)
3. OGUS SAVAS (TUR)
5. NEAGU-BARZAN ALEXANDRE (ROU)
5. CALIFANO EMANUELE (ITA)
7. MABIC FILIP (CRO)
7. PRANNYCHUK NAZARII (UKR)

Pool winner-Junior Kumite Male -61 kg

Karate1 Youth League - Venice 2024, PALAZZO DEL TURISMO, Piazza Brescia 11, 30016 Lido di Jesolo VE, ITA

2024-12-06

Tatami
5 14:40

Pool
1/1

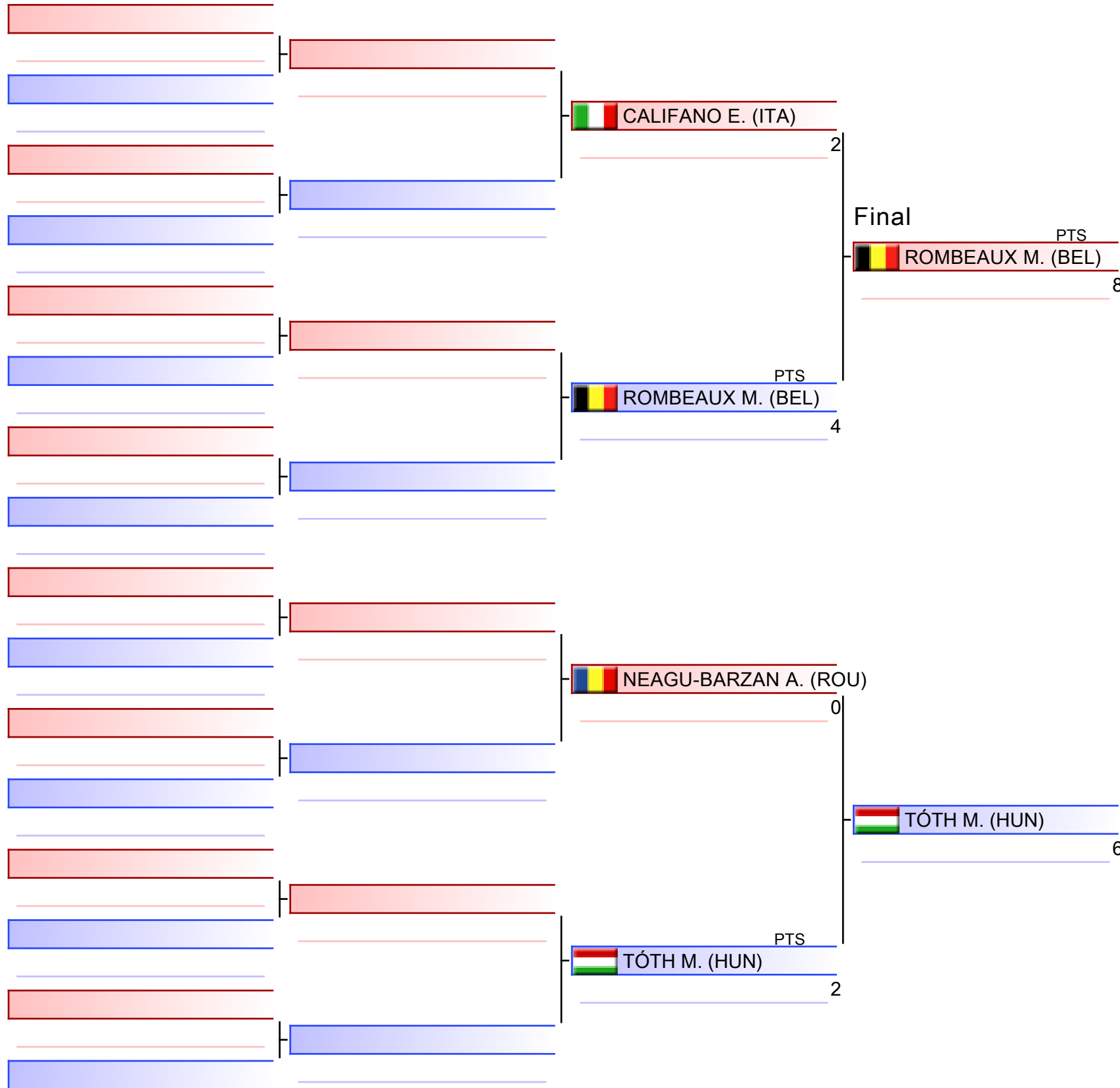

ROMBEAUX M. (BEL)

1. ROMBEAUX MATT (BEL)
2. TÓTH MÁTÉ ROLAND (HUN)
3. LUNGU LUCIAN (ROU)
3. OGUS SAVAS (TUR)
5. NEAGU-BARZAN ALEXANDRE (ROU)
5. CALIFANO EMANUELE (ITA)
7. MABIC FILIP (CRO)
7. PRANNYCHUK NAZARII (UKR)

Junior Kumite Male -61 kg

Karate1 Youth League - Venice 2024

2024-12-06

Tatami
6 19:00

Pool
4,3,2,1

(c)sportdata GmbH & Co KG 2000-2024 (2024-12-08 20:16) v 10.2.0 build 1 (2024-11-20 00:58 CET) License: SDIL TVG (expire 2025-01-26)

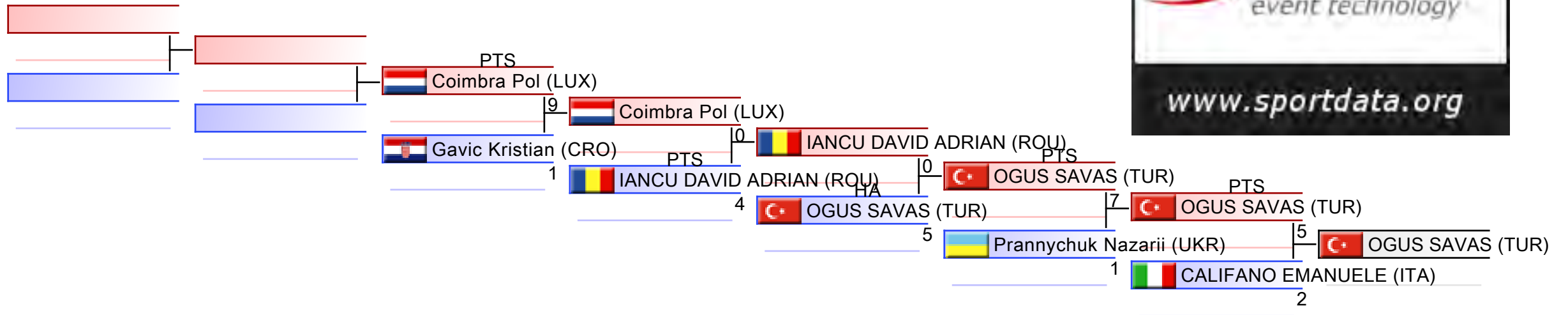

REPECHAGE: (4,3,2,1)

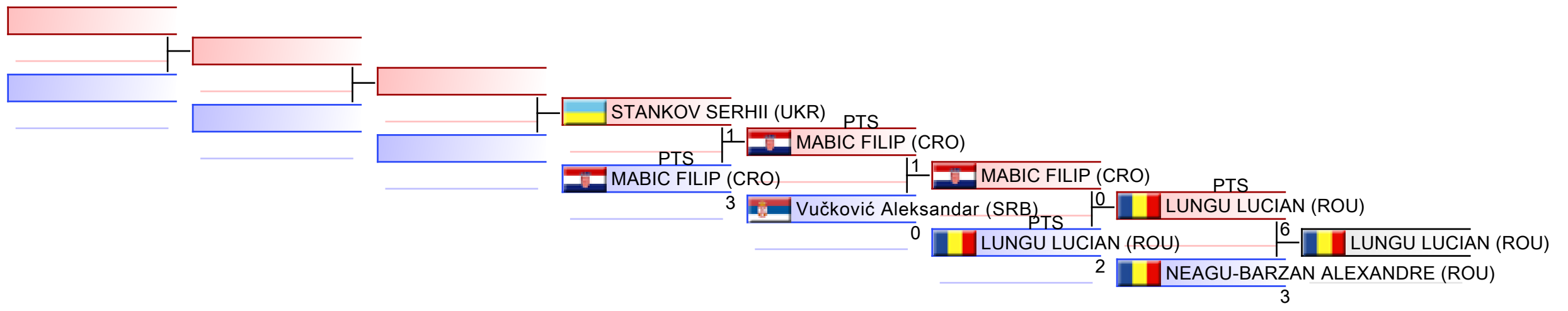



Karate1 Youth League - Venice 2024 - 2024-12-04



Official Results

Junior Kumite Male -61 kg (Entries: 90 Nations: 30)			
1	ROMBEAUX MATT		BEL - BELGIUM
2	TÓTH MÁTÉ ROLAND		HUN - HUNGARY
3	LUNGU LUCIAN		ROU - ROMANIA
3	OGUS SAVAS		TUR - TURKIYE
5	NEAGU-BARZAN ALEXANDRE		ROU - ROMANIA
5	CALIFANO EMANUELE		ITA - ITALY
7	MABIC FILIP		CRO - CROATIA
7	PRANNYCHUK NAZARII		UKR - UKRAINE
9	VUČKOVIĆ ALEKSANDAR		SRB - SERBIA
9	IANCU DAVID ADRIAN		ROU - ROMANIA
11	STANKOV SERHII		UKR - UKRAINE
11	COIMBRA POL		LUX - LUXEMBOURG
13	GAVIC KRISTIAN		CRO - CROATIA

JUNIOR KUMITE MALE -68 KG



Karate1 Youth League - Venice 2024

ENTRIES BY WEIGHT CATEGORY



Junior Kumite Male -68 kg

As of 8 DEC 2024

Country Code	ID	Gender	Name	Seeding
ALB	ALB2221	M	PJETRI ERNIK	
AND	AND02229	M	DE LUCA SOARES DAVID	
ARM	ARM003056	M	SARGSYAN MIKAYEL	
AUT		M	Fleisch Tobias	
BEL	BEL02528	M	ZOUEINI RAYAN	
BIH	BIH2669	M	Arnautovic Ali	
BIH		M	Rozajac Adin	
BUL		M	Mihaylov Petar	
BUL		M	Tsanev Nikolay	
CAN	CAN03081	M	HENault EMMANUEL-TADEO	
CAN	CAN003890	M	KERDOUSSI ABDESSALAM	
CRO	CRO2864	M	BURSIC LEON	
CRO		M	Magzan Ivano	
CRO		M	Penezic Ivano	
CRO	CRO03027	M	Pervan Zeljko	
CRO	CRO03240	M	Tuskán Sven	
CRO	CRO03036	M	Zeljko Matej	
CYP	CYP02938	M	Antoniou Joel	
CYP	CYP02943	M	ANTONIOY NIKOLAS	
CYP	CYP02831	M	MATSIS NICOLAS	
CZE	CZE02344	M	BEDNAR ONDREJ	
CZE	CZE02845	M	Buresh Karel	
ENG		M	Bennett Malek	
ENG	SD28184	M	Hasib Ameer	
ENG		M	Packford Harry	
ENG	ENG02766	M	Wilkins Logan	
ESP	ESP02997	M	BAEZ RODRIGUEZ CRISTOBAL	
ESP		M	ESCOBAR JARA DANIEL JOSE	
ESP		M	Fernández Maza Paul	
ESP		M	MORATA SANCHEZ CARLOS	
FRA	FRA03295	M	Boisnet Sacha	
FRA	SD041989	M	SEBBAG Hugo	
GER		M	Müller Jonas	
GER	GER003925	M	RAISWICH ROMAN	
GER		M	Ruris Adrian	
GER		M	Zeitler Fabian	
GRE	GRE02456	M	KARRAS PETROS	
HUN		M	Felszner Erik	
HUN	HUN02532	M	Tóth Zsombor Zoltán	
ITA		M	ANNOVAZZI MATTEO	
ITA		M	ARECCO MATTEO	
ITA	ITA04408	M	BASILE MANUEL	
ITA		M	Brogi Tommaso	
ITA		M	Cinagli Federico	
ITA		M	DORIA MATTEO	



Karate1 Youth League - Venice 2024

ENTRIES BY WEIGHT CATEGORY



Junior Kumite Male -68 kg

As of 8 DEC 2024

Country Code	ID	Gender	Name	Seeding
ITA		M	gagliardo salvatore	
ITA	ITA04533	M	GIGLIOTTA GIUSEPPE	
ITA	ITA04273	M	KOROTENKO MICHAEL	
ITA		M	LAVACCA DANIELE	
ITA	ITA04510	M	Liguori Cristian	
ITA		M	Lussignoli Diego	
ITA		M	Mariani Lorenzo	
ITA		M	Marrazzo Mario	
ITA		M	Martini Simone	
ITA		M	NAZZARO Lorenzo	
ITA	ITA04262	M	ODELLO ANDREA	
ITA		M	ONORATI MATTIA	
ITA		M	RUSSOMANNO GIOELE ANTONIO	
ITA		M	Scarano Antonio	
ITA		M	TOMMASINO ALMERICCO	
ITA	ITA04449	M	TONIOLO ALVISE	
ITA	ITA04411	M	ZANELLI FILIPPO	
KOS	KOS02916	M	MUSTAFA HARIS	
LAT		M	Kurmels Glebs	
NED		M	Kouwenhoven Daan	
NED	NED02676	M	Krijnen Thomas	
POL	POL2493	M	Fierek Jan	
POL		M	Kośmider Franciszek	
POL	POL2634	M	SZCZEPANSKI SZYMON	
POL	POL2338	M	SZUBSKI KASPER	
POL	POL3812	M	Tarkowski Patryk	
POR		M	Barbosa Diogo	
POR		M	Cristina David	
POR		M	Pereira Afonso	
POR		M	Tomé Francisco	
POR		M	Veiga Tiago	
ROU	ROU03743	M	BOGZA GABRIEL	
ROU	ROU03330	M	GHERASE DAVID GEORGE	
ROU	ROU03751	M	PAVEL MIHAI IULIAN	
SCO	SCO02200	M	Packwood Benjamin	
SLO	SLO003076	M	GOSTISA VAN GENNIP NICK	
SLO	SLO02710	M	ROLA LUKA	
SUI	SUI02734	M	KARLEN Théo	
SUI		M	Sieber Elija	
SUI		M	Tscharner Loan	
SVK		M	Páleš Richard	
SWE	SWE003127	M	HASSAS JACOB	
SWE	SWE003122	M	NASER AHMED	
TKM	TKM02653	M	SAPAROV SULEYMAN	
UKR	UKR03141	M	HRYNENKO ILLIA	



Karate1 Youth League - Venice 2024
ENTRIES BY WEIGHT CATEGORY



Junior Kumite Male -68 kg
As of 8 DEC 2024

Country Code	ID	Gender	Name	Seeding
UKR		M	Ozoruba Nazarii	
UKR		M	Shumovych Mykhailo	

Junior Kumite Male -68 kg

Karate1 Youth League - Venice 2024, PALAZZO DEL TURISMO, Piazza Brescia 11, 30016 Lido di Jesolo VE, ITA

2024-12-06

Tatami
5 14:50

Pool
1/4

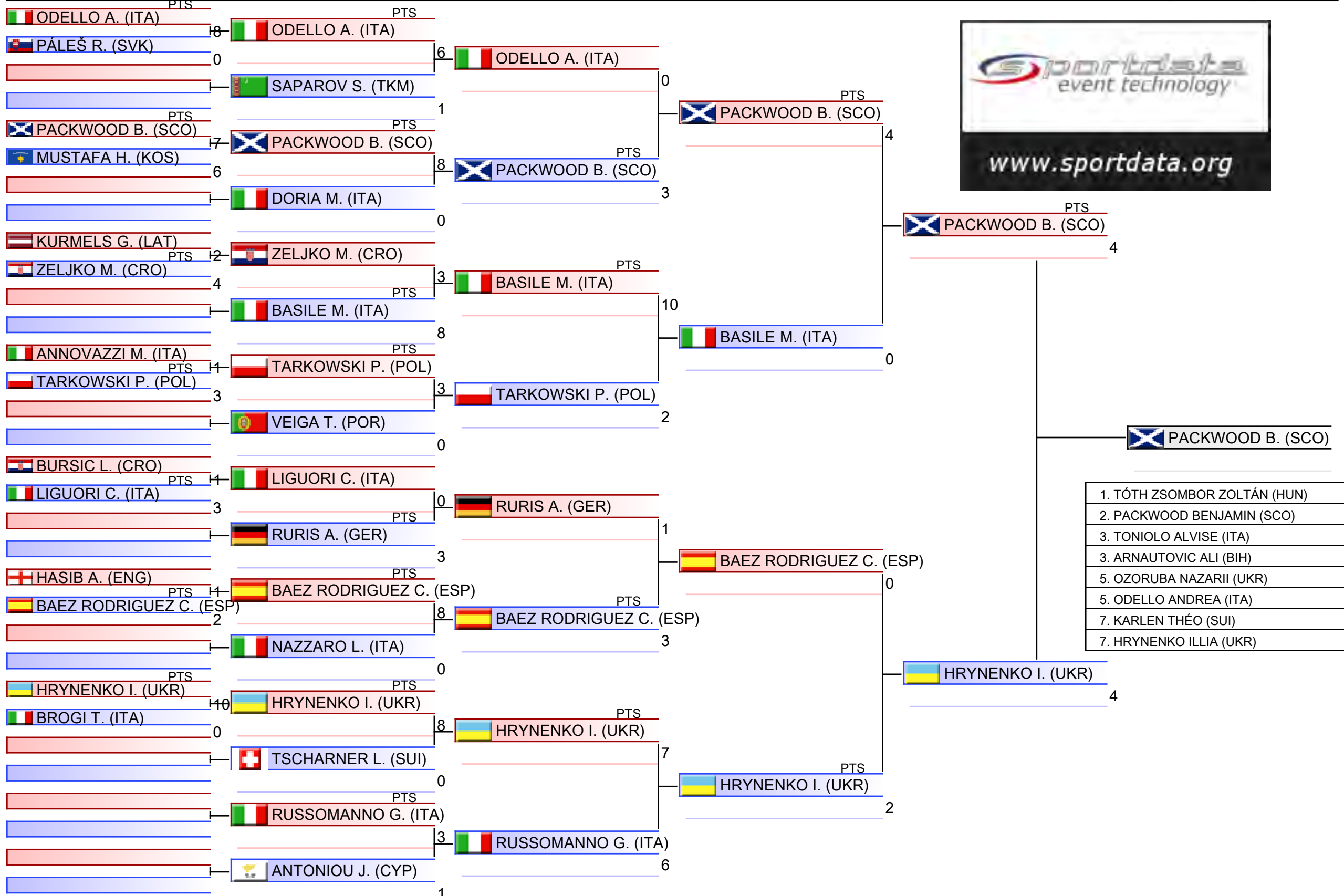

1. TÓTH ZSOMBOR ZOLTÁN (HUN)
2. PACKWOOD BENJAMIN (SCO)
3. TONIOLO ALVISE (ITA)
3. ARNAUTOVIC ALI (BIH)
5. OZORUBA NAZARII (UKR)
5. ODELLO ANDREA (ITA)
7. KARLEN THÉO (SUI)
7. HRYNENKO ILLIA (UKR)

Junior Kumite Male -68 kg

Karate1 Youth League - Venice 2024, PALAZZO DEL TURISMO, Piazza Brescia 11, 30016 Lido di Jesolo VE, ITA

2024-12-06

Tatami
6 14:50

Pool
2/4

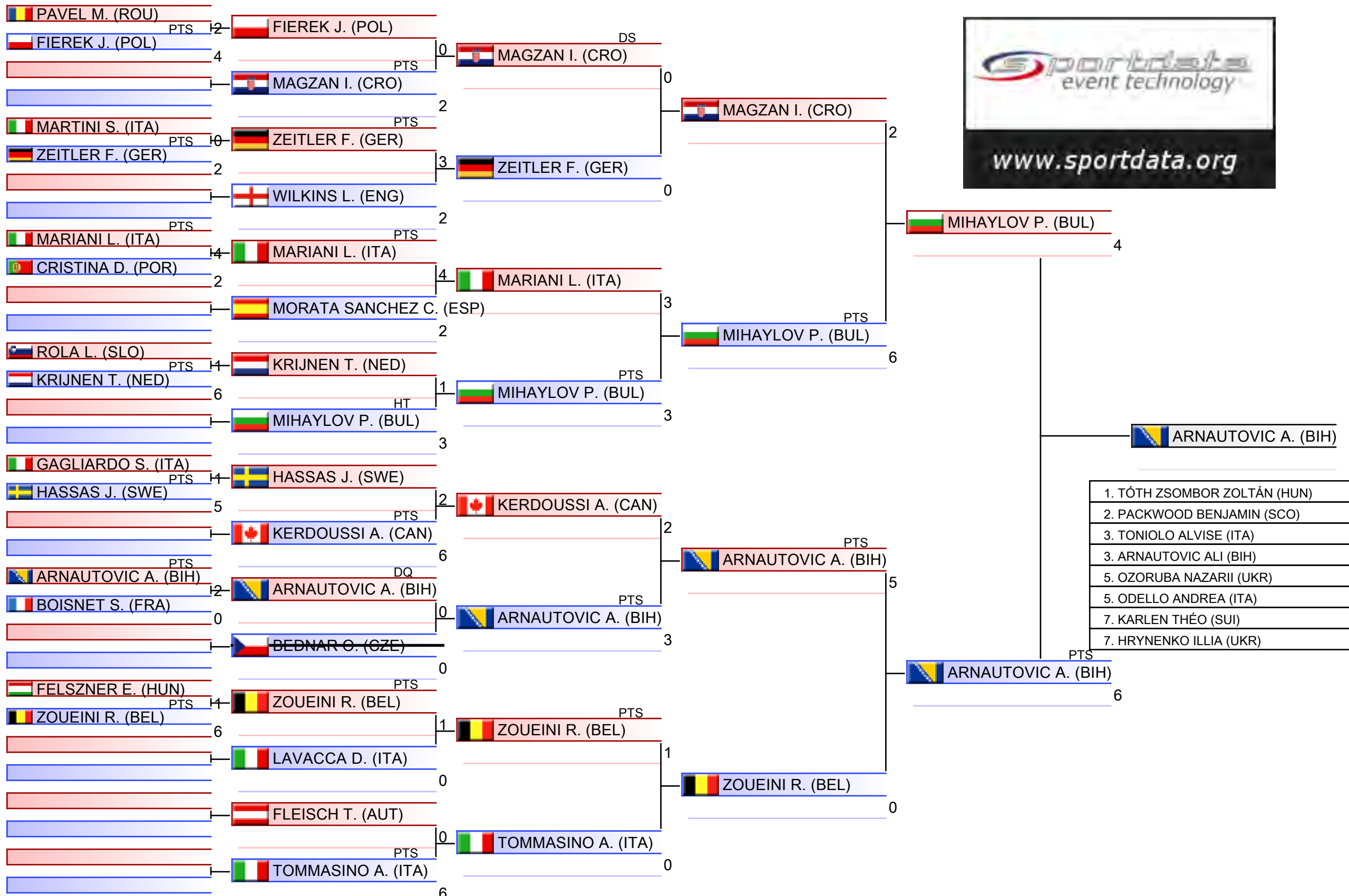

- | |
|------------------------------|
| 1. TÓTH ZSOMBOR ZOLTÁN (HUN) |
| 2. PACKWOOD BENJAMIN (SCO) |
| 3. TONIOLO ALVISE (ITA) |
| 3. ARNAUTOVIC ALI (BIH) |
| 5. OZORUBA NAZARII (UKR) |
| 5. ODELLO ANDREA (ITA) |
| 7. KARLEN THÉO (SUI) |
| 7. HRYNENKO ILLIA (UKR) |

Junior Kumite Male -68 kg

Karate1 Youth League - Venice 2024, PALAZZO DEL TURISMO, Piazza Brescia 11, 30016 Lido di Jesolo VE, ITA

2024-12-06

Tatami
7 14:50

Pool
3/4

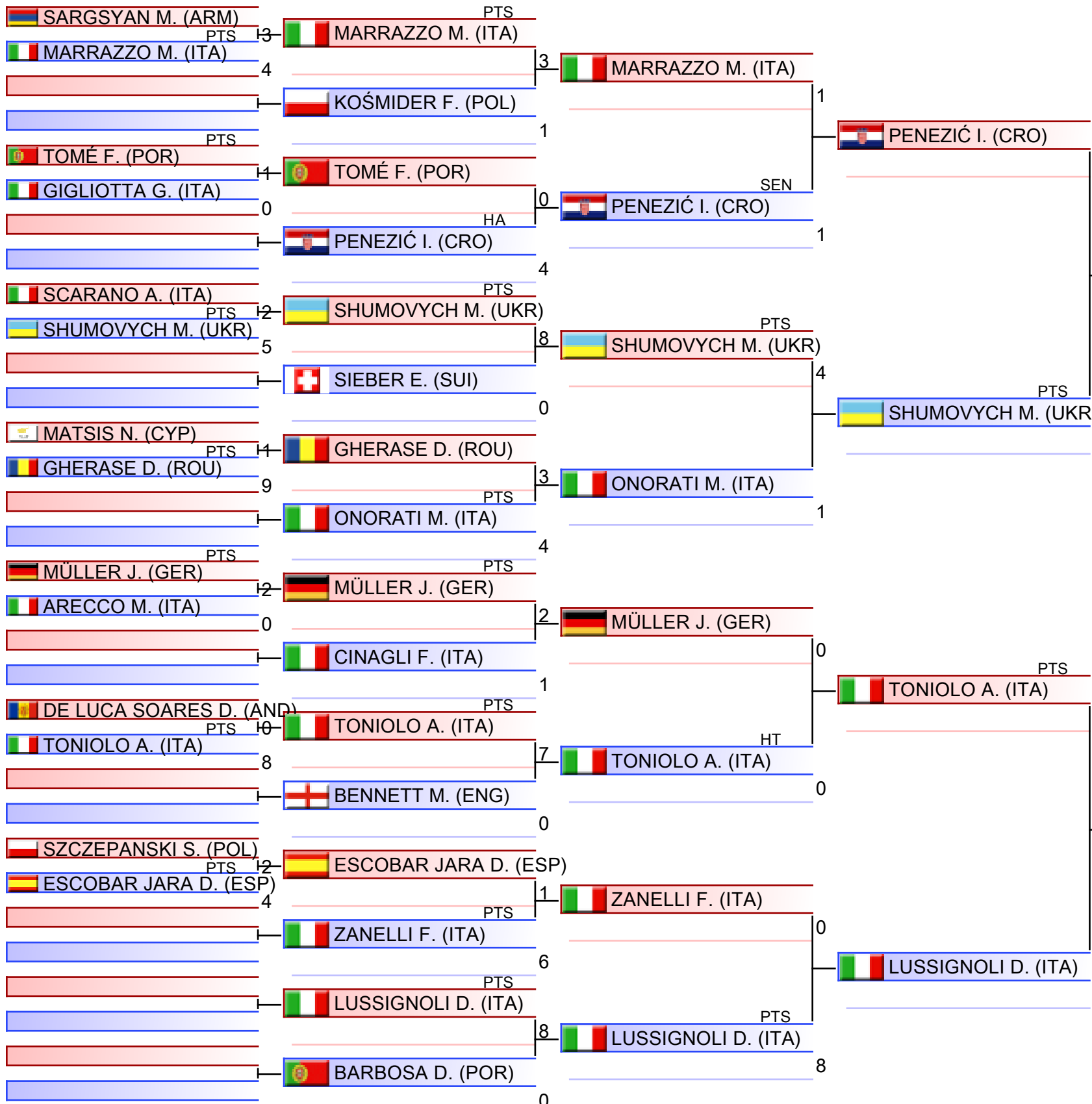

- | |
|------------------------------|
| 1. TÓTH ZSOMBOR ZOLTÁN (HUN) |
| 2. PACKWOOD BENJAMIN (SCO) |
| 3. TONIOLO ALVISE (ITA) |
| 3. ARNAUTOVIC ALI (BIH) |
| 5. OZORUBA NAZARII (UKR) |
| 5. ODELLO ANDREA (ITA) |
| 7. KARLEN THÉO (SUI) |
| 7. HRYNENKO ILLIA (UKR) |

Junior Kumite Male -68 kg

Karate1 Youth League - Venice 2024, PALAZZO DEL TURISMO, Piazza Brescia 11, 30016 Lido di Jesolo VE, ITA

2024-12-06

Tatami
8 14:50

Pool
4/4

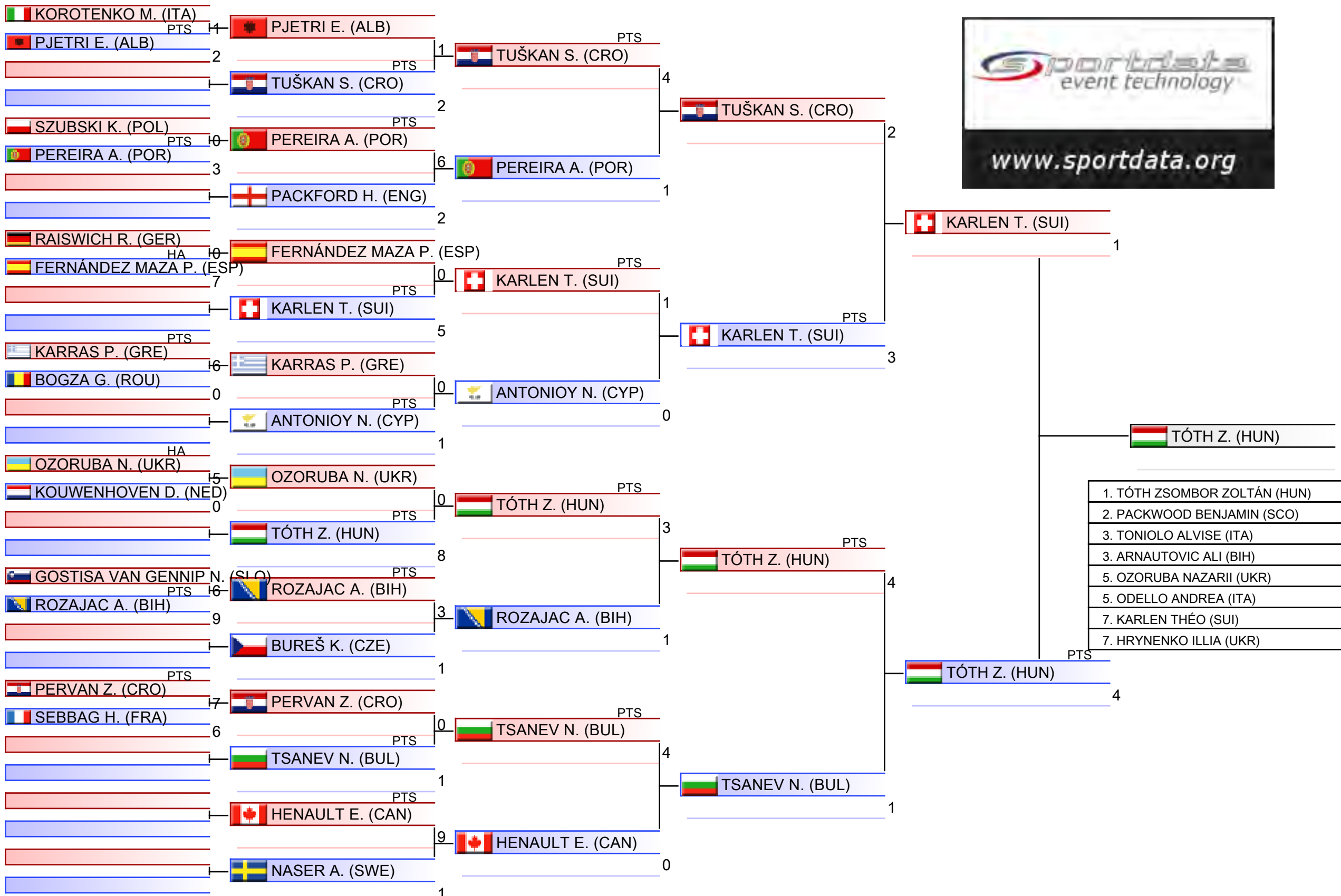

1. TÓTH ZSOMBOR ZOLTÁN (HUN)
2. PACKWOOD BENJAMIN (SCO)
3. TONIOLO ALVISE (ITA)
3. ARNAUTOVIC ALI (BIH)
5. OZORUBA NAZARII (UKR)
5. ODELLO ANDREA (ITA)
7. KARLEN THÉO (SUI)
7. HRYNENKO ILLIA (UKR)

Pool winner-Junior Kumite Male -68 kg

Karate1 Youth League - Venice 2024, PALAZZO DEL TURISMO, Piazza Brescia 11, 30016 Lido di Jesolo VE, ITA

2024-12-06

Tatami

5 16:50

Pool

1/1

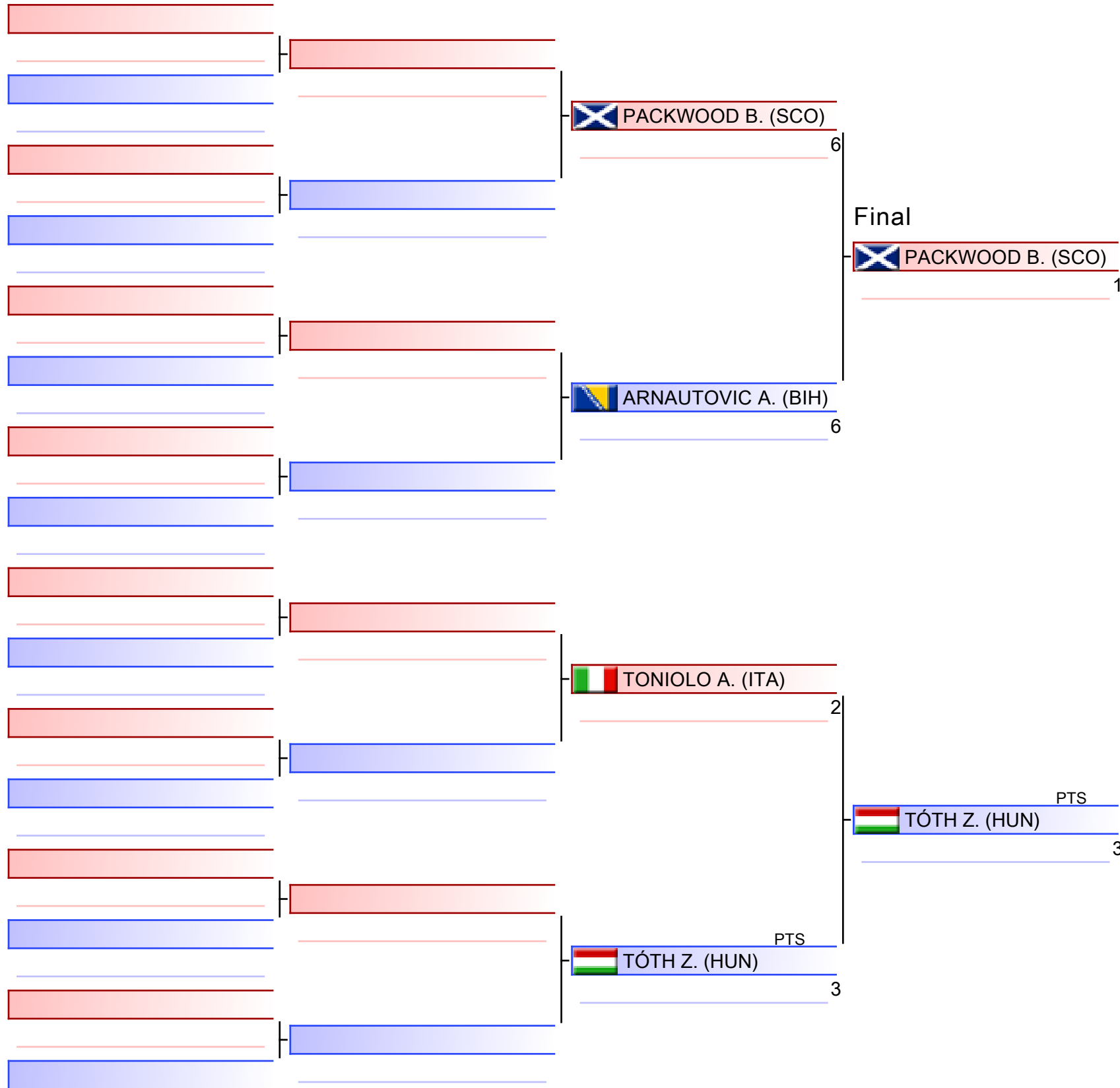

TÓTH Z. (HUN)

1. TÓTH ZSOMBOR ZOLTÁN (HUN)
2. PACKWOOD BENJAMIN (SCO)
3. TONIOLO ALVISE (ITA)
3. ARNAUTOVIC ALI (BIH)
5. OZORUBA NAZARII (UKR)
5. ODELLO ANDREA (ITA)
7. KARLEN THÉO (SUI)
7. HRYNENKO ILLIA (UKR)

Junior Kumite Male -68 kg

Karate1 Youth League - Venice 2024

2024-12-06

Tatami

7 19:10

Pool

1,2,3,4

(c)sportdata GmbH & Co KG 2000-2024 (2024-12-08 20:16) v 10.2.0 build 1 (2024-11-20 00:58 CET) License: SDIL TVG (expire 2025-01-26)

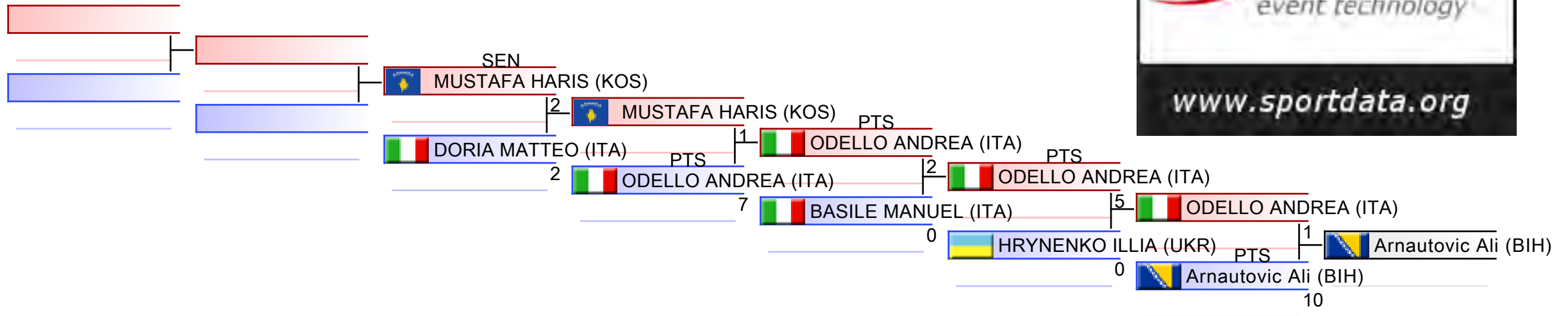

REPECHAGE: (1,2,3,4)

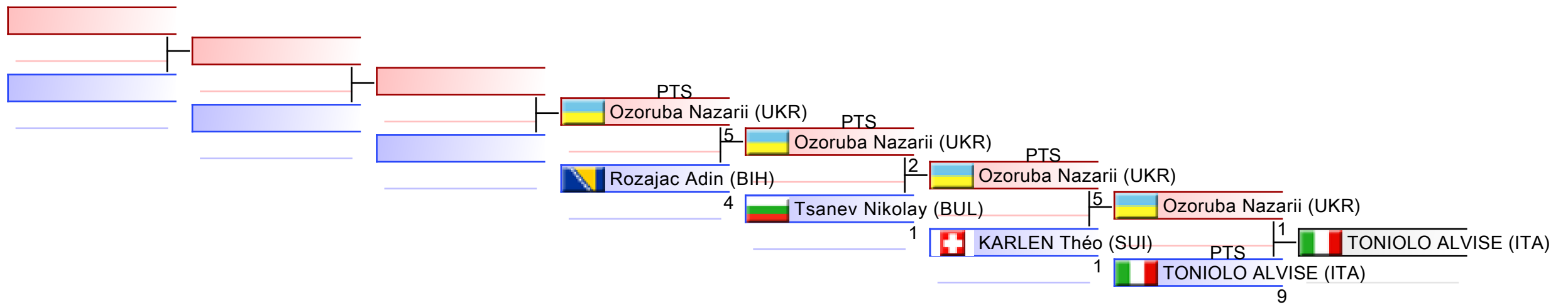



Karate1 Youth League - Venice 2024 - 2024-12-04



Official Results

Junior Kumite Male -68 kg (Entries: 92 Nations: 31)			
1	TÓTH ZSOMBOR ZOLTÁN		HUN - HUNGARY
2	PACKWOOD BENJAMIN		SCO - SCOTLAND
3	TONIOLO ALVISE		ITA - ITALY
3	ARNAUTOVIC ALI		BIH - BOSNIA AND HERZEGOVINA
5	OZORUBA NAZARII		UKR - UKRAINE
5	ODELLO ANDREA		ITA - ITALY
7	KARLEN THÉO		SUI - SWITZERLAND
7	HRYNENKO ILLIA		UKR - UKRAINE
9	TSANEV NIKOLAY		BUL - BULGARIA
9	BASILE MANUEL		ITA - ITALY
11	ROZAJAC ADIN		BIH - BOSNIA AND HERZEGOVINA
11	MUSTAFA HARIS		KOS - KOSOVO
13	DORIA MATTEO		ITA - ITALY

JUNIOR KUMITE MALE -76 KG



Karate1 Youth League - Venice 2024

ENTRIES BY WEIGHT CATEGORY



Junior Kumite Male -76 kg

As of 8 DEC 2024

Country Code	ID	Gender	Name	Seeding
ARM	ARM03008	M	KOSAKYAN SUREN	
AUT		M	Debro Jakob	
AUT	AUT02781	M	Platisa Pascal	
AZE	AZE02700	M	GAYIBOV JAHANGIR	
BEL		M	EI Aidi Yahya	
BEL		M	Jaber rais Wassim	
BIH		M	Kadrić Muamer	
BIH		M	Mušanović Faris	
BUL		M	Nikolov Ivan	
BUL		M	Vasilev Aleksandar	
CAN	CAN03073	M	MONGRAIN THIERRY	
CRO	SD77170	M	Huzjak Nikola	
CRO	SD699953	M	Jeromić Noel	
CRO	SD77168	M	Lukačić Luka	
CRO	CRO2812	M	Panić Karlo	
CRO	CRO2660	M	STRAHIJA SVEN	
ENG		M	Bowen Tai	
ENG		M	Cutler Jacob	
ENG		M	Dawson Glyn	
ENG		M	Elliot Aiden	
ESP		M	ASPERILLA DIAZ RUBÉN	
ESP	ESP02871	M	Leal Moreno Iker	
ESP		M	MARTINEZ JIMENEZ PABLO	
ESP		M	Martin Peña Izan	
ESP	ESP02999	M	TAMAYO RUIZ BORJA	
FRA		M	Boudriga Bilel	
GER		M	Elenberger Alexander	
GER	GER03280	M	Heller Ben	
GER	GER03358	M	Knopp Phil	
GER	GER03262	M	Koch Adrian	
GER		M	Korhan Yasin	
GER		M	Rath Konstantin	
GER	SD60980	M	Voigt Tilmann	
GER		M	Yildirim Senol	
GER	GER03123	M	ZUNIGA SPAETHE ROBIN MATEO	
HUN		M	Czudor Olivér	
HUN		M	Tülkös Roland Nándor	
ITA		M	Calandi Roberto	
ITA	SD51449	M	CAPRITTI ENEA	
ITA		M	Caridei Christian	
ITA		M	CARRARESI ALESSANDRO	
ITA		M	Castellano Michele	
ITA		M	Domi Saimon	
ITA		M	Genocchio Manuel	
ITA	ITA04214	M	Ingenito Gennaro	



Karate1 Youth League - Venice 2024

ENTRIES BY WEIGHT CATEGORY



Junior Kumite Male -76 kg

As of 8 DEC 2024

Country Code	ID	Gender	Name	Seeding
ITA	ITA04412	M	MONDINI LUCA	
ITA		M	Montanari Valerio	
ITA		M	PULLIERO ALESSANDRO	
ITA		M	strangio giulio	
ITA		M	Tamberi Alessandro	
ITA		M	Verrastro Riccardo	
KOS	KOS03451	M	ARIFI AMMAR	
KOS	KOS003631	M	MUSTAFA OMER	
KOS		M	Peci Gent	
LAT	LAT2141	M	Vorožeikins Leonids	
LUX	LUX02472	M	Serra Rodrigues Tiago	
NED	SD60506	M	Twisk Patrick	
POL	POL2489	M	Kołodziejczak Przemysław	
POL	POL07924	M	POLEJOWSKI MIKOLAJ	
POL	POL2543	M	Sojka Fabian	
POL	POL05610	M	WOJARSKI WIKTOR	
POL	POL3106	M	WOZNIAK KAJETAN	
POR		M	Abreu Tiago	
POR		M	Almeida Tomás Duarte de	
POR		M	Carvalho Jaime	
POR		M	Pereira João	
ROU	ROU003969	M	ALEXANDRU GABRIEL TRASCA	
ROU	ROU003955	M	ANDREI CONSTANTIN	
ROU	ROU02985	M	BUDAN PIRVU PATRICK ALEX	
ROU	ROU02984	M	GLODEANU MARC	
ROU	ROU03108	M	LAPUSCA IONUT-ADRIAN	
ROU	ROU03372	M	POPESCU MATHIAS	
SLO	SLO02586	M	MLAKAR LUKA	
SRB		M	Stojanovic Ognjen	
SUI	SUI02697	M	Pedro Théo	
SVK	SVK02875	M	Turčaník Richard	
SWE	SWE003198	M	DURDEVIC NIKOLA	
TUR	TUR2681	M	KELES Osman Burak	
UKR	UKR03060	M	Bilous Danylo	
UKR	SD48959	M	Hlushchenko Artur	
UKR	UKR03148	M	KOSTIUKOV TYMUR	
UKR	SD49020	M	Kovalchuk Arsen	
UKR		M	Lisovyi Vadym	
UKR		M	Matseruk Oleksandr	
UKR	UKR03064	M	Nimizhan Stanislav	
UKR	SD48414	M	PAKHOMOV HLIB	
UKR		M	Ravliuk Dmytro	

Junior Kumite Male -76 kg

Karate1 Youth League - Venice 2024, PALAZZO DEL TURISMO, Piazza Brescia 11, 30016 Lido di Jesolo VE, ITA

2024-12-06

Tatami
1 15:45

Pool
1/4

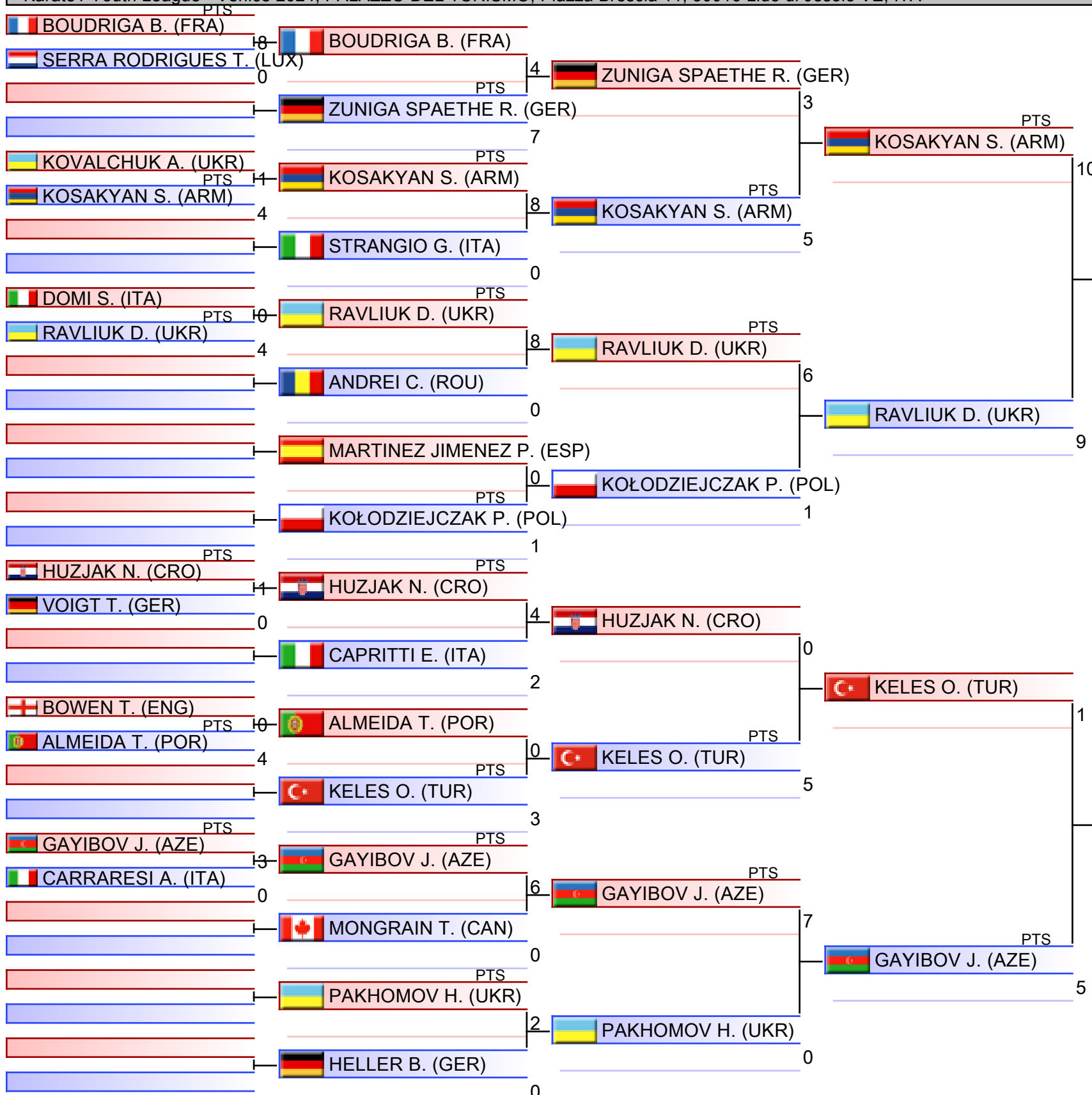

1. STRAHIIJA SVEN (CRO)
2. PLATISA PASCAL (AUT)
3. VERRASTRO RICCARDO (ITA)
3. WOJARSKI WIKTOR (POL)
5. GAYIBOV JAHANGIR (AZE)
5. MARTIN PEÑA IZAN (ESP)
7. BUDAN PIRVU PATRICK ALEX (ROU)
7. GLODEANU MARC (ROU)

Junior Kumite Male -76 kg

Karate1 Youth League - Venice 2024, PALAZZO DEL TURISMO, Piazza Brescia 11, 30016 Lido di Jesolo VE, ITA

2024-12-06

Tatami
2 15:45

Pool
2/4

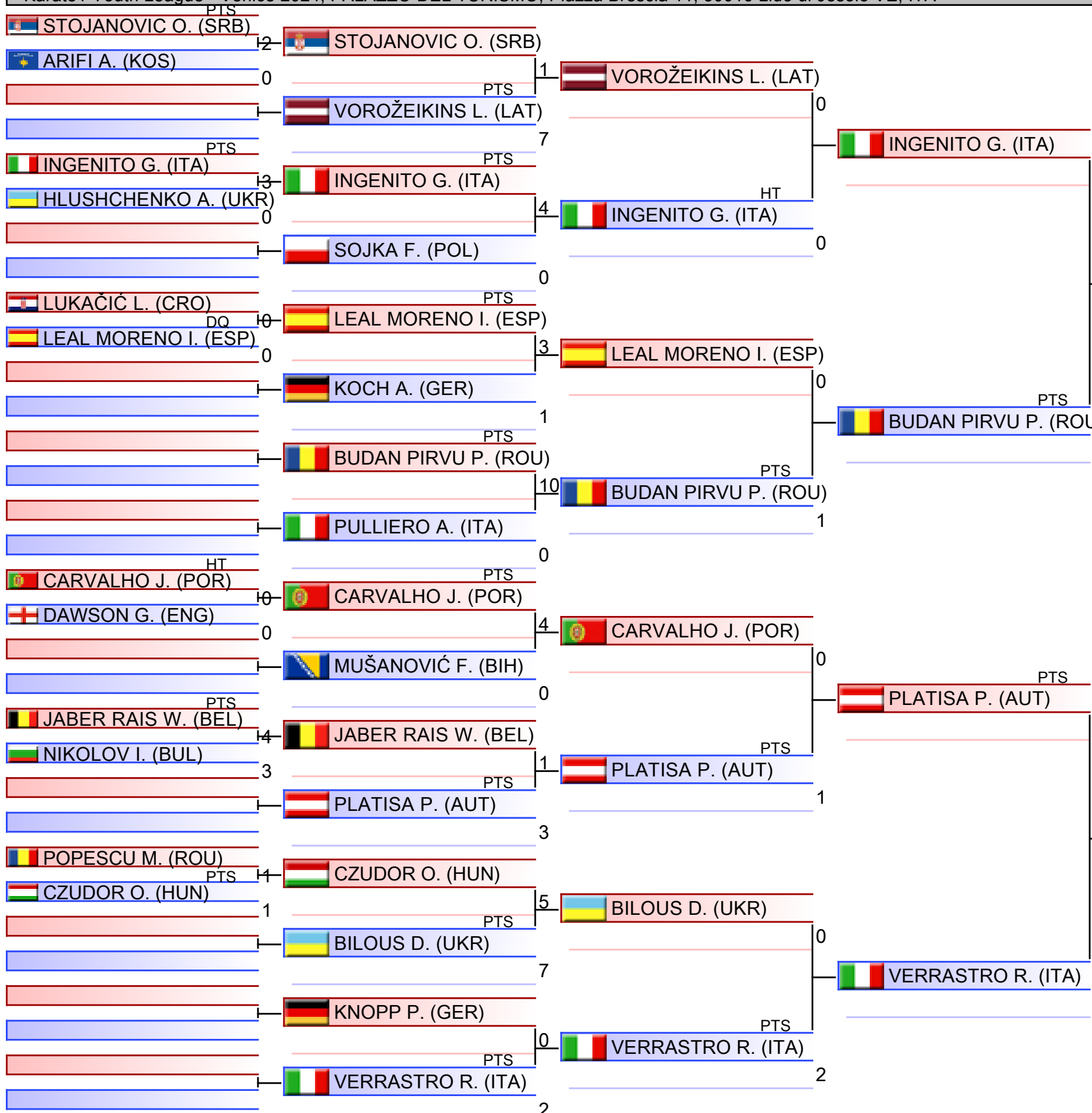

1. STRAHIIJA SVEN (CRO)
2. PLATISA PASCAL (AUT)
3. VERRASTRO RICCARDO (ITA)
3. WOJARSKI WIKTOR (POL)
5. GAYIBOV JAHANGIR (AZE)
5. MARTIN PEÑA IZAN (ESP)
7. BUDAN PIRVU PATRICK ALEX (ROU)
7. GLODEANU MARC (ROU)

Junior Kumite Male -76 kg

Karate1 Youth League - Venice 2024, PALAZZO DEL TURISMO, Piazza Brescia 11, 30016 Lido di Jesolo VE, ITA

2024-12-06

Tatami
3 15:45

Pool
3/4

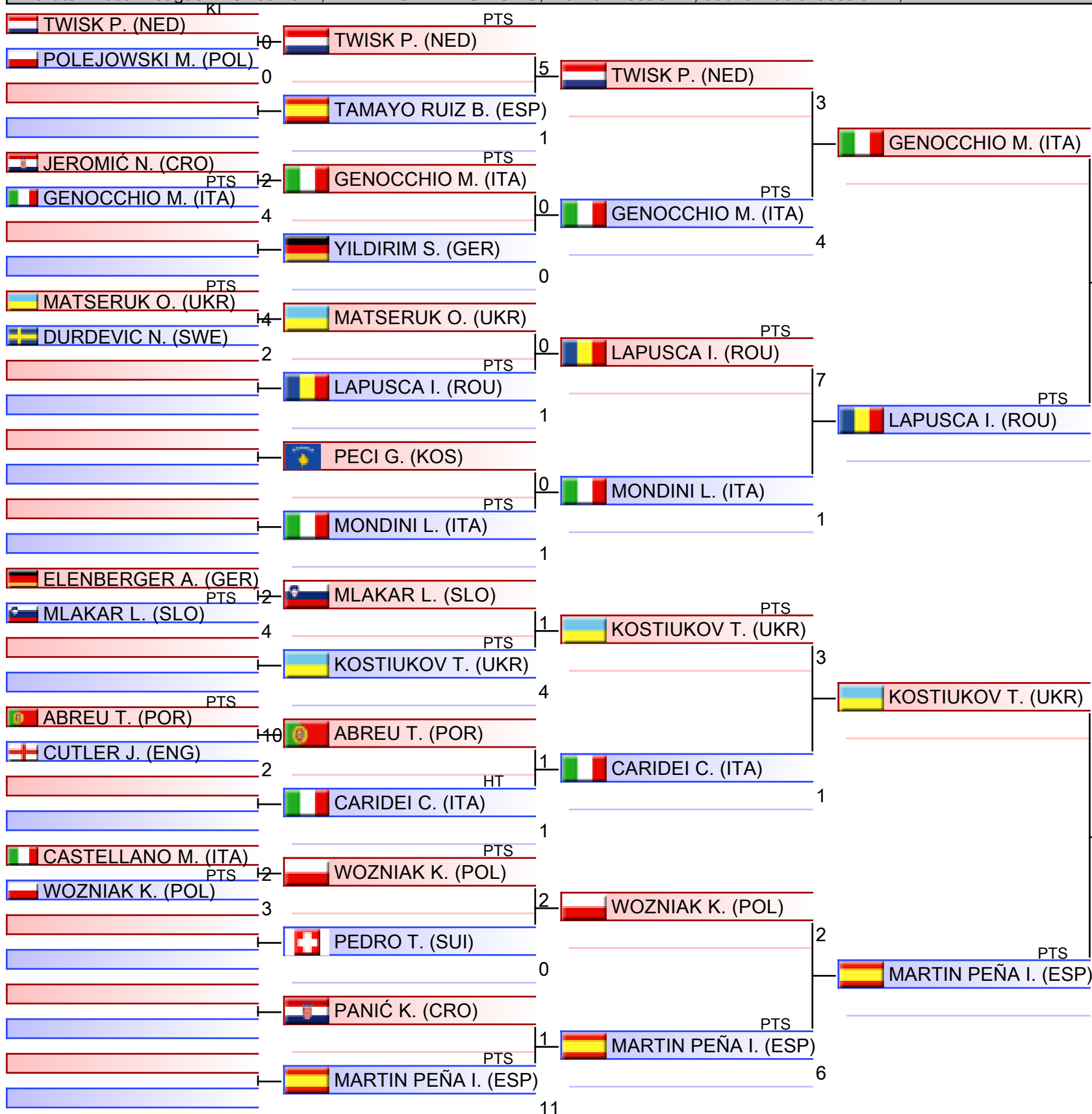

- | |
|-----------------------------------|
| 1. STRAHIIJA SVEN (CRO) |
| 2. PLATISA PASCAL (AUT) |
| 3. VERRASTRO RICCARDO (ITA) |
| 3. WOJARSKI WIKTOR (POL) |
| 5. GAYIBOV JAHANGIR (AZE) |
| 5. MARTIN PEÑA IZAN (ESP) |
| 7. BUDAN PIRVU PATRICK ALEX (ROU) |
| 7. GLODEANU MARC (ROU) |

Junior Kumite Male -76 kg

Karate1 Youth League - Venice 2024, PALAZZO DEL TURISMO, Piazza Brescia 11, 30016 Lido di Jesolo VE, ITA

2024-12-06

Tatami
4 15:45

Pool
4/4

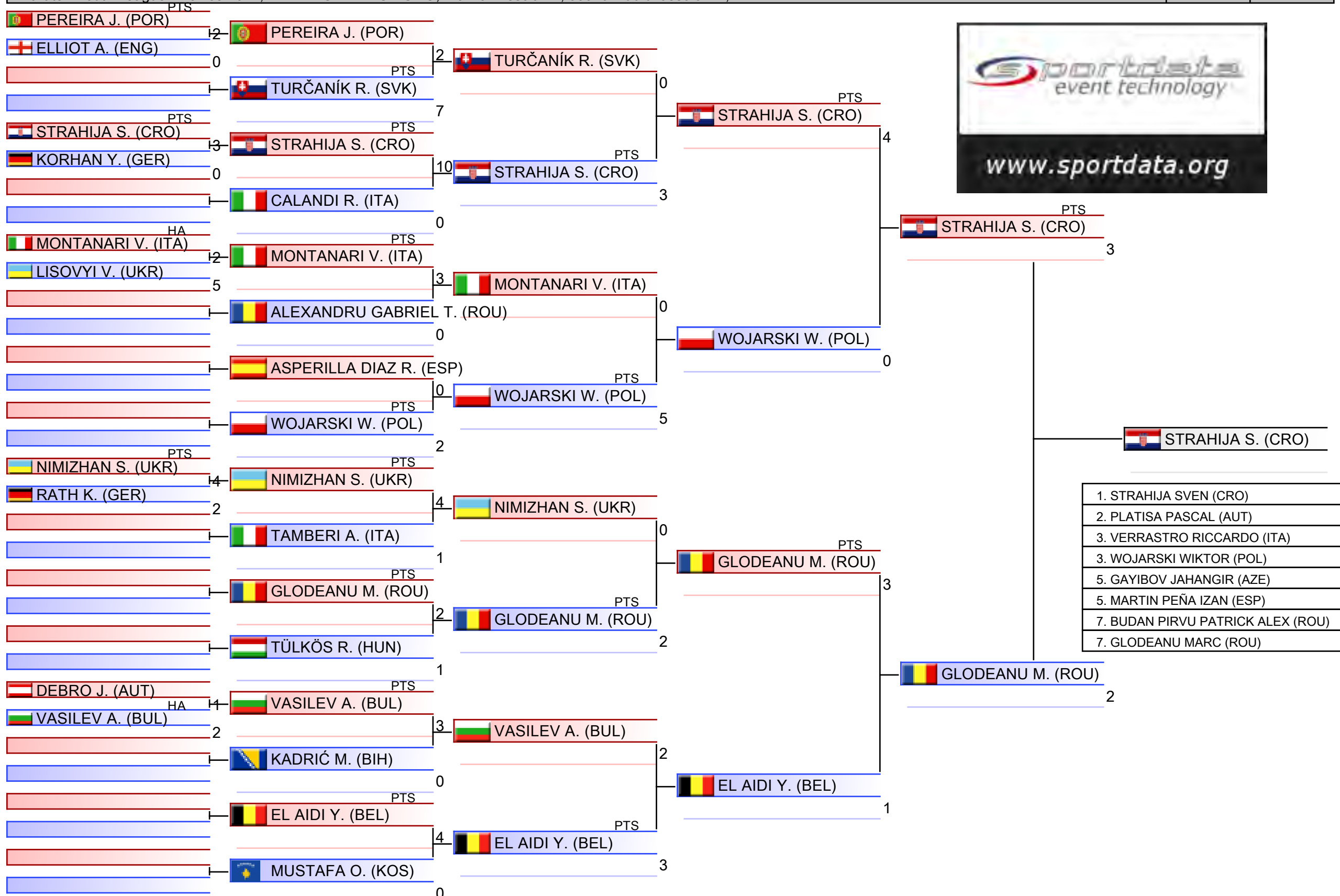

1. STRAHIJA SVEN (CRO)
2. PLATISA PASCAL (AUT)
3. VERRASTRO RICCARDO (ITA)
3. WOJARSKI WIKTOR (POL)
5. GAYIBOV JAHANGIR (AZE)
5. MARTIN PEÑA IZAN (ESP)
7. BUDAN PIRVU PATRICK ALEX (ROU)
7. GLODEANU MARC (ROU)

Pool winner-Junior Kumite Male -76 kg

Karate1 Youth League - Venice 2024, PALAZZO DEL TURISMO, Piazza Brescia 11, 30016 Lido di Jesolo VE, ITA

2024-12-06

Tatami
1 17:40

Pool
1/1

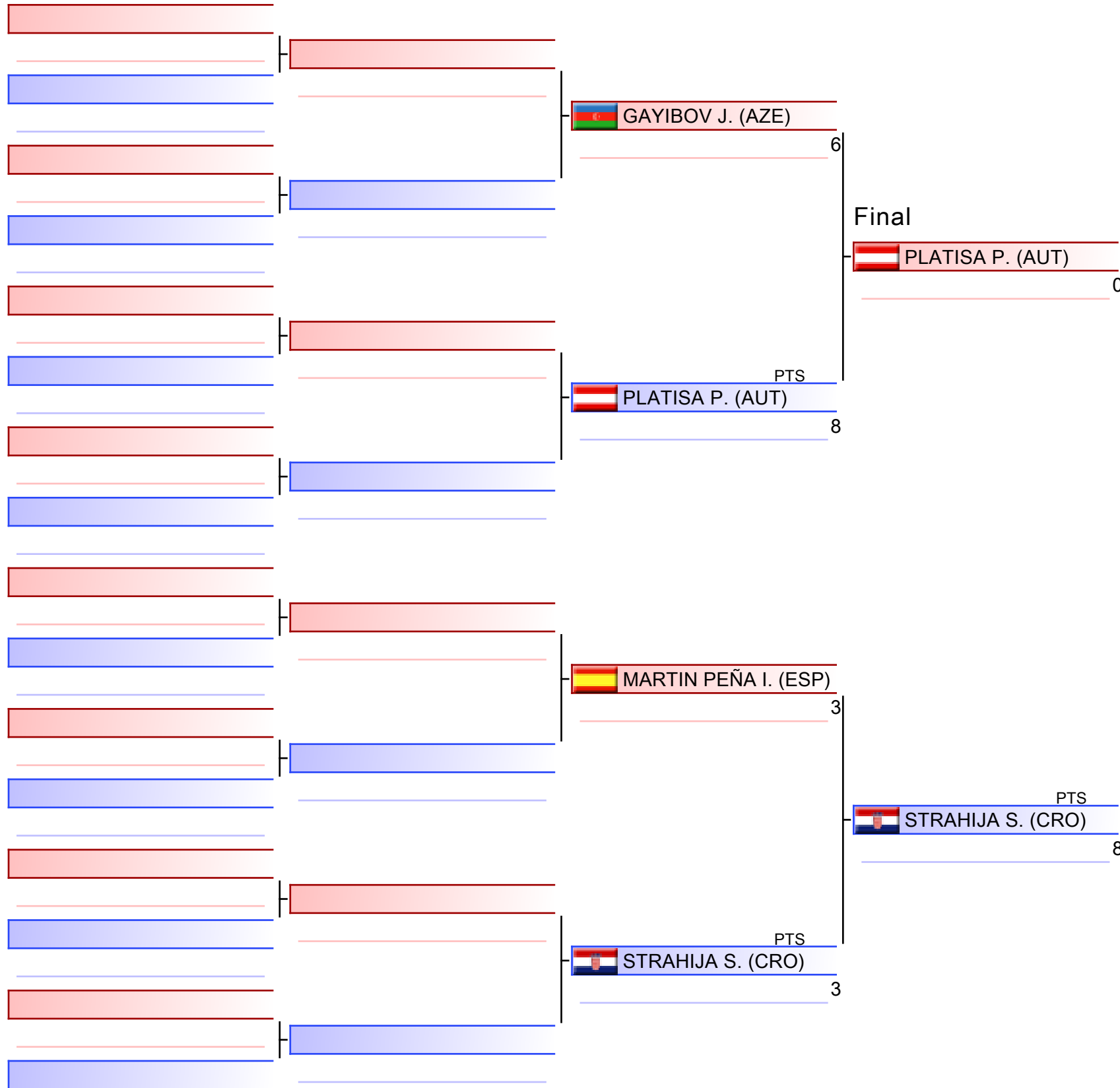

STRAHIJA S. (CRO)

1. STRAHIJA SVEN (CRO)
2. PLATISA PASCAL (AUT)
3. VERRASTRO RICCARDO (ITA)
3. WOJARSKI WIKTOR (POL)
5. GAYIBOV JAHANGIR (AZE)
5. MARTIN PEÑA IZAN (ESP)
7. BUDAN PIRVU PATRICK ALEX (ROU)
7. GLODEANU MARC (ROU)



Karate1 Youth League - Venice 2024 - 2024-12-04



Official Results

Junior Kumite Male -76 kg (Entries: 87 Nations: 28)			
1	STRAHIJA SVEN		CRO - CROATIA
2	PLATISA PASCAL		AUT - AUSTRIA
3	VERRASTRO RICCARDO		ITA - ITALY
3	WOJARSKI WIKTOR		POL - POLAND
5	GAYIBOV JAHANGIR		AZE - AZERBAIJAN
5	MARTIN PEÑA IZAN		ESP - SPAIN
7	BUDAN PIRVU PATRICK ALEX		ROU - ROMANIA
7	GLODEANU MARC		ROU - ROMANIA
9	CARVALHO JAIME		POR - PORTUGAL
9	TURČANIK RICHARD		SVK - SLOVAKIA
11	JABER RAIS WASSIM		BEL - BELGIUM
11	KORHAN YASIN		GER - GERMANY
13	CALANDI ROBERTO		ITA - ITALY

JUNIOR KUMITE MALE 76+ KG



Karate1 Youth League - Venice 2024

ENTRIES BY WEIGHT CATEGORY



Junior Kumite Male 76+ kg

As of 8 DEC 2024

Country Code	ID	Gender	Name	Seeding
AUT		M	Mayr Werner	
AUT	AUT02528	M	SELIMOVIC ARMIN	
BEL	BEL02521	M	ANISIMOV VLADISLAV	
BEN	BEN02121	M	ADJANONHOUN IHSANE	
BIH	BIH03884	M	Jeličić Nemanja	
BIH		M	Konjhodzic Faris	
BIH		M	Koprena Filip	
BIH		M	Mešić Arnes	
BIH		M	Pipal Adi	
BIH		M	Setic Tarik	
BIH		M	Smajić Harun	
BUL	BUL02454	M	Atanasov Teodor	
BUL		M	Sotirov Bojidar	
CAN	CAN03062	M	IHAZA SIMON	
CRC	CRC002631	M	CARDENAS EDUARDO	
CRO		M	KRUSLIN SVEN	
CRO		M	Suhina Matej	
CRO	CRO03139	M	Turkovic Vito	
CRO	CRO2708	M	VRANKOVIC MARIO	
CRO		M	Vukoja Lovro	
CYP		M	THEMISTOCLEOUS CHARALAMBOS	
DEN	DEN02839	M	Kjærgaard Simon Grønlund	
ENG		M	Lokaj Drin	
ESP		M	GUTIERREZ SANZ SAUL	
ESP	ESP02865	M	MIRESAN SECHEI CRISTIAN ALEXANDRU	
ESP	ESP56635	M	VISO NAVARRO HUGO	
FIN	FIN02182	M	Mantere Jimi	
FRA		M	AKGUN Muhammed Ali	
FRA		M	Blanc Kevin	
FRA		M	BOUADJEHINE Lazhar	
FRA		M	Dabi Zakariya	
FRA	SD66035	M	Ribes Bastien	
GEO	GEO02556	M	GIGAURI NIKOLOZ	
GER	GER03809	M	FRENSEL PAUL	
GER		M	Knauer Benedikt Franz Xaver	
GER		M	Ridiger Eric	
GER	GER02761	M	Tschenisch Thore	
GRE	GRE02448	M	MOKAS MICHAEL	
GRE	GRE02900	M	PSOMAS ILIAS	
HUN		M	Árkos Olivér	
HUN		M	David Lisal	
HUN		M	Huszár Márk	
ITA		M	Amarie Alessio Filippo	
ITA		M	Branchi Niccolò	
ITA	ITA04409	M	BURROSI SAMUELE	



Karate1 Youth League - Venice 2024

ENTRIES BY WEIGHT CATEGORY



Junior Kumite Male 76+ kg

As of 8 DEC 2024

Country Code	ID	Gender	Name	Seeding
ITA		M	Di Mattia Tommaso	
ITA		M	FRANCO ANTONIO	
ITA	ITA04473	M	LIBERTI Santino	
ITA	ITA04443	M	Magnani Riccardo	
ITA		M	Materano Daniele	
ITA		M	Mostarda Ettore	
ITA	ITA04474	M	PELAGGI Agostino	
ITA		M	Realini Niccolò	
ITA		M	Risito Matteo	
ITA		M	Rizzo Alessandro	
ITA		M	Ulqinaku Leonardo	
KOS	KOS03191	M	MORINA LEON	
KOS	KOS02902	M	OSMANI BLERAND	
NED		M	de Rover Luke	
NED		M	El Jattari Mohammed Amine	
NED	SD45032	M	Kamel Basem	
NED	SD44431	M	van der Vliet Merijn	
NOR		M	Syrrist-Gelgota Julius Leander	
POL	POL2737	M	SARBA KRZYSZTOF	
POL	POL3363	M	SZCZEGIELNIAK PIOTR	
POR		M	ALVES DIOGO GABRIEL	
POR		M	Marçal João	
ROU	ROU03801	M	BARCIU IONUT VALENTIN	
ROU	ROU02716	M	GEORGESCU THEODOR PETRU	
ROU	ROU03370	M	IHNATIUC OCTAVIAN RAZVAN	
ROU	ROU2291	M	IONASCU EDUARD	
ROU	ROU03594	M	PRITA ARIS LUCA	
ROU	ROU003968	M	RADU STEFAN SERBAN	
ROU	ROU003954	M	ROBERT ADRIAN GOZI	
ROU	ROU03744	M	SALOMIA DRAGOS IONUT	
SLO	SLO03039	M	GACIC ALEKSANDER	
SLO	SLO02990	M	STOJADINOVIC TIMOTEJ	
SRB		M	Milošević Ilija	
SRB		M	Milunovic Stefan	
SRB		M	Stepanovic El Samer Luka	
SUI	SUI02692	M	Bandelier Mathis	
SVK	SVK02638	M	Bohunický Lukáš	
SVK		M	Gočik Tomáš Daniel	
SVK		M	Hnyk Ronald	
SVK	SVK02807	M	Sáraz Martin	
TUR		M	YAĞLI KEREM TUĞRA	
UKR	UKR03147	M	KIRIA HELA	
UKR		M	TARASENKO ARTEM	
UKR		M	Tenzhala Ivan	
VEN		M	Leon Soto Lezker David	



Karate1 Youth League - Venice 2024

ENTRIES BY WEIGHT CATEGORY



Junior Kumite Male 76+ kg

Karate1 Youth League - Venice 2024, PALAZZO DEL TURISMO, Piazza Brescia 11, 30016 Lido di Jesolo VE, ITA

2024-12-06

Tatami
5 17:00

Pool
1/4

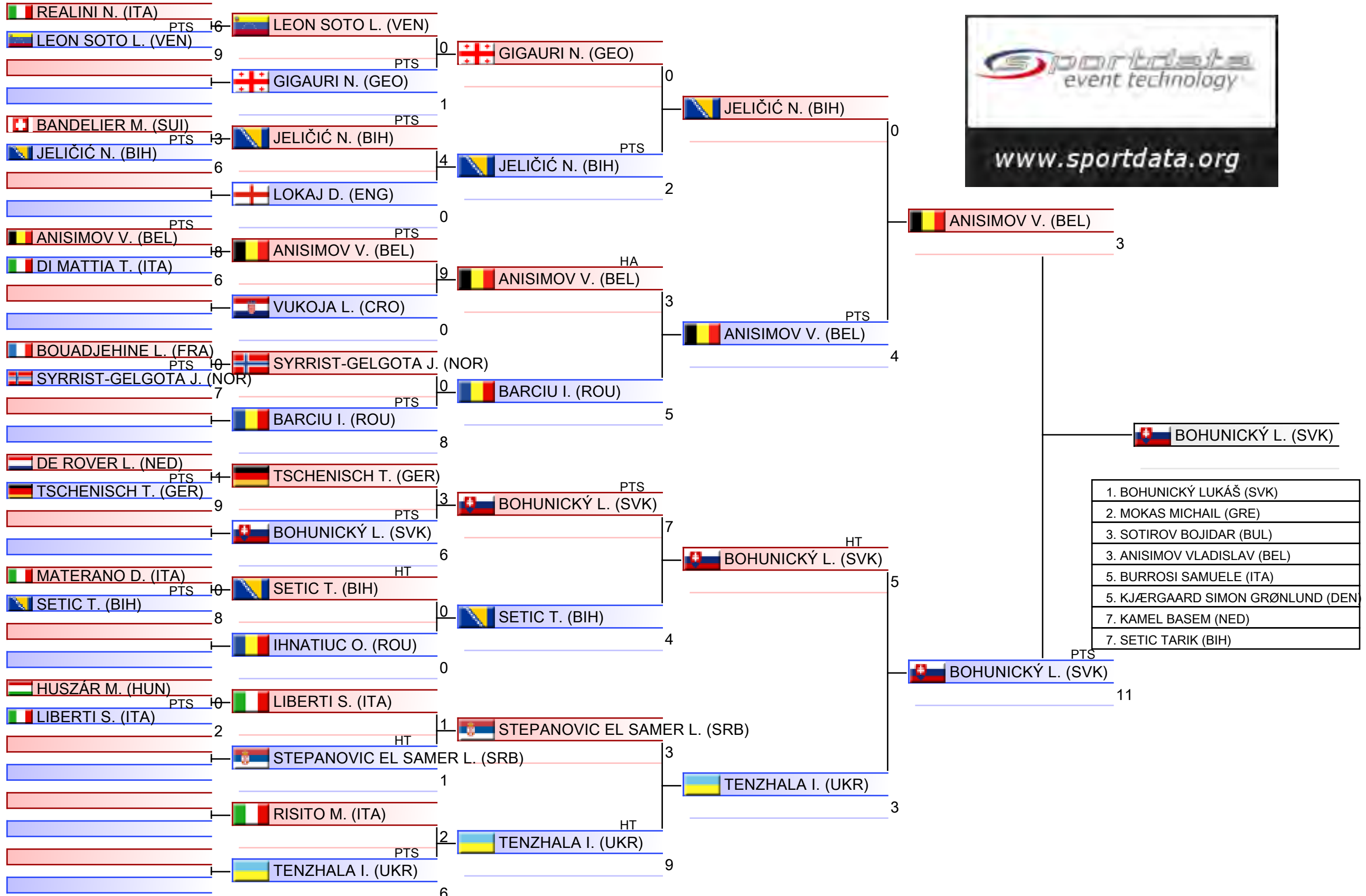

Junior Kumite Male 76+ kg

Karate1 Youth League - Venice 2024, PALAZZO DEL TURISMO, Piazza Brescia 11, 30016 Lido di Jesolo VE, ITA

2024-12-06

Tatami
6 17:00

Pool
2/4

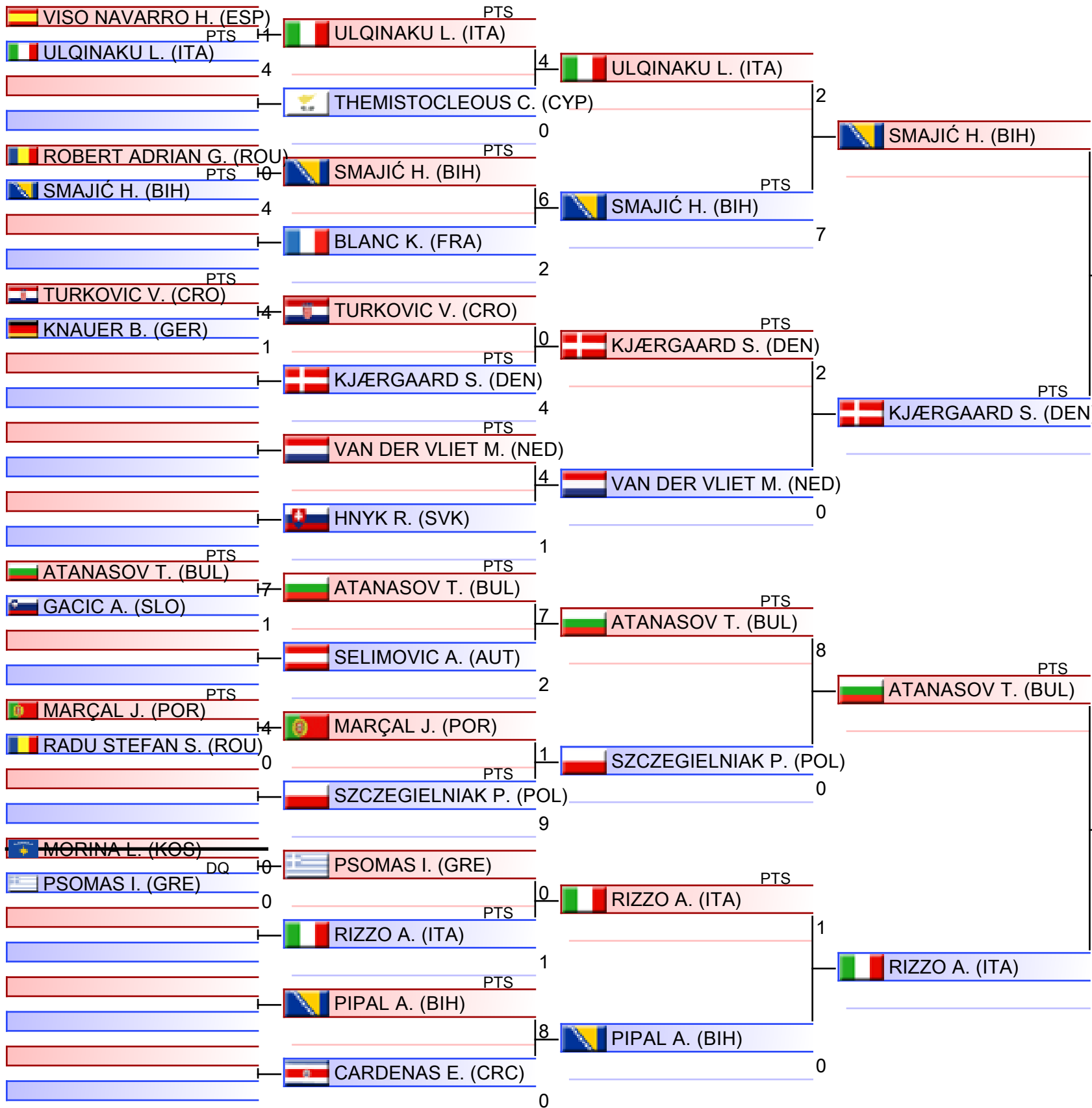

- | |
|-----------------------------------|
| 1. BOHUNICKÝ LUKÁŠ (SVK) |
| 2. MOKAS MICHAEL (GRE) |
| 3. SOTIROV BOJIDAR (BUL) |
| 3. ANISIMOV VLADISLAV (BEL) |
| 5. BURROSI SAMUELE (ITA) |
| 5. KJÆRGAARD SIMON GRØNLUND (DEN) |
| 7. KAMEL BASEM (NED) |
| 7. SETIC TARIK (BIH) |

Junior Kumite Male 76+ kg

Karate1 Youth League - Venice 2024, PALAZZO DEL TURISMO, Piazza Brescia 11, 30016 Lido di Jesolo VE, ITA

2024-12-06

Tatami
7 17:00

Pool
3/4

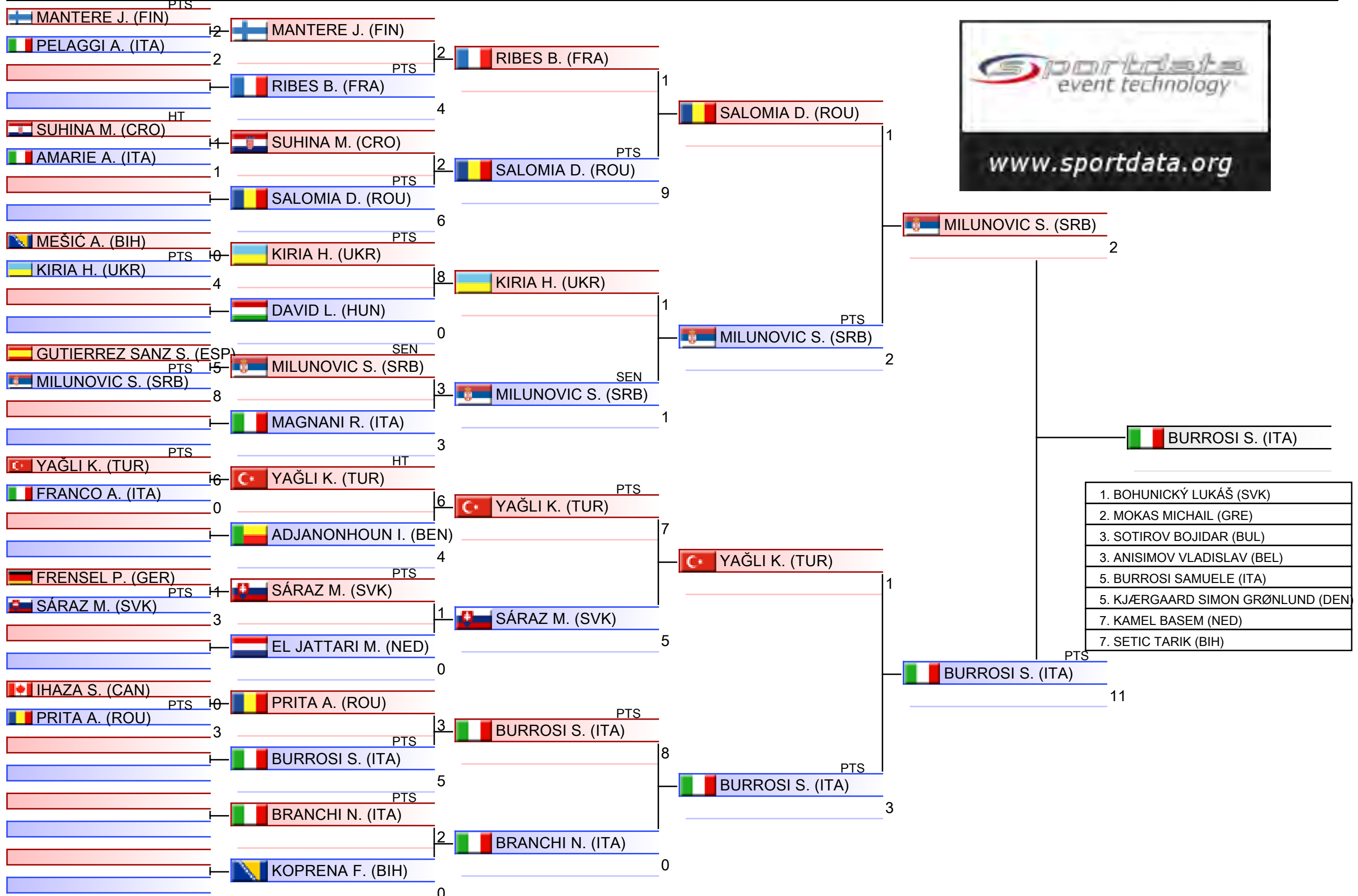

1. BOHUNICKÝ LUKÁŠ (SVK)
2. MOKAS MICHAEL (GRE)
3. SOTIROV BOJIDAR (BUL)
3. ANISIMOV VLADISLAV (BEL)
5. BURROSI SAMUELE (ITA)
5. KJÆRGAARD SIMON GRØNLUND (DEN)
7. KAMEL BASEM (NED)
7. SETIC TARIK (BIH)

Junior Kumite Male 76+ kg

Karate1 Youth League - Venice 2024, PALAZZO DEL TURISMO, Piazza Brescia 11, 30016 Lido di Jesolo VE, ITA

2024-12-06

Tatami
8 17:00

Pool
4/4

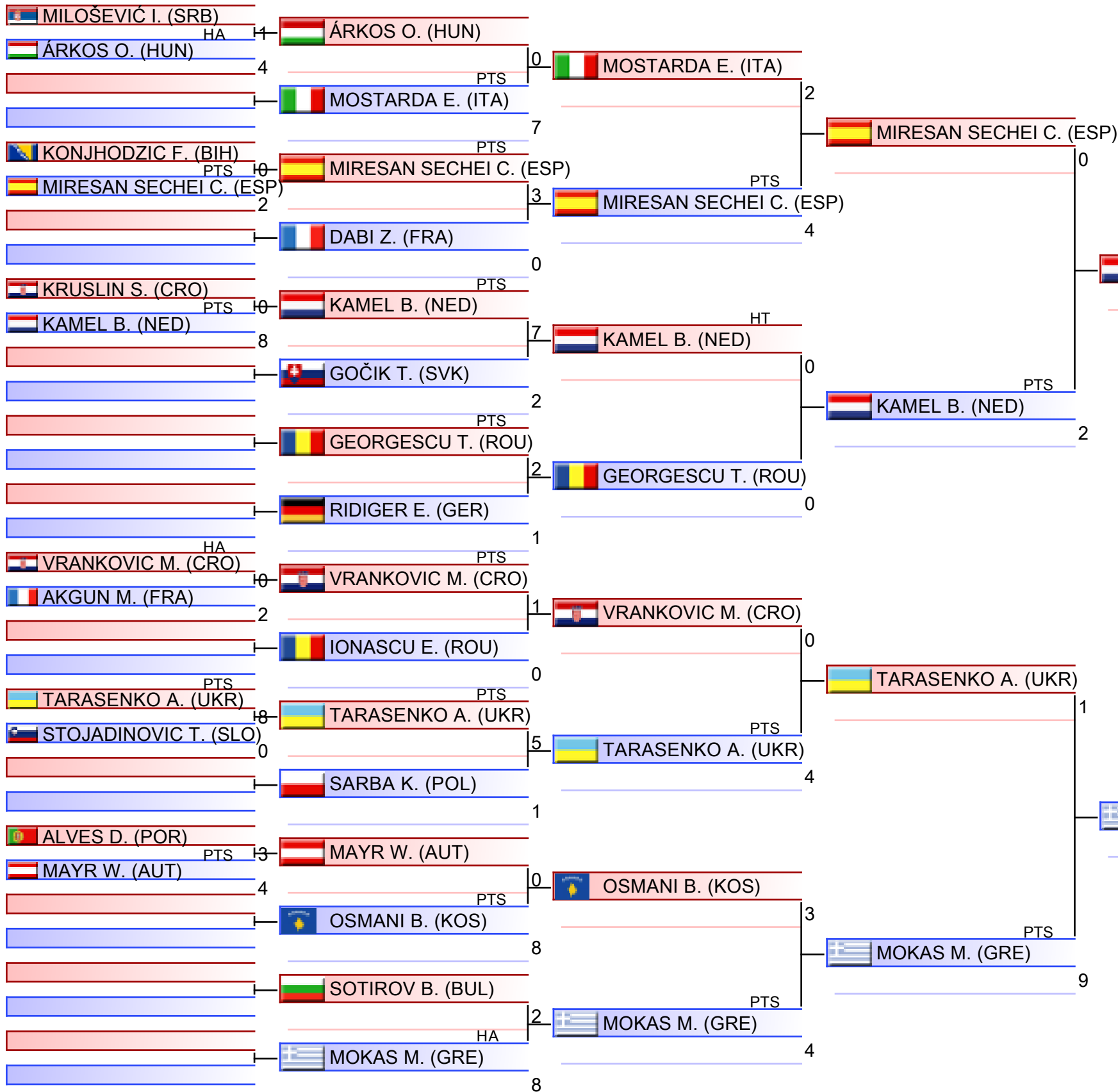

- | |
|-----------------------------------|
| 1. BOHUNICKÝ LUKÁŠ (SVK) |
| 2. MOKAS MICHAEL (GRE) |
| 3. SOTIROV BOJIDAR (BUL) |
| 3. ANISIMOV VLADISLAV (BEL) |
| 5. BURROSI SAMUELE (ITA) |
| 5. KJÆRGAARD SIMON GRØNLUND (DEN) |
| 7. KAMEL BASEM (NED) |
| 7. SETIC TARIK (BIH) |

Pool winner-Junior Kumite Male 76+ kg

Karate1 Youth League - Venice 2024, PALAZZO DEL TURISMO, Piazza Brescia 11, 30016 Lido di Jesolo VE, ITA

2024-12-06

Tatami
5 19:00

Pool
1/1

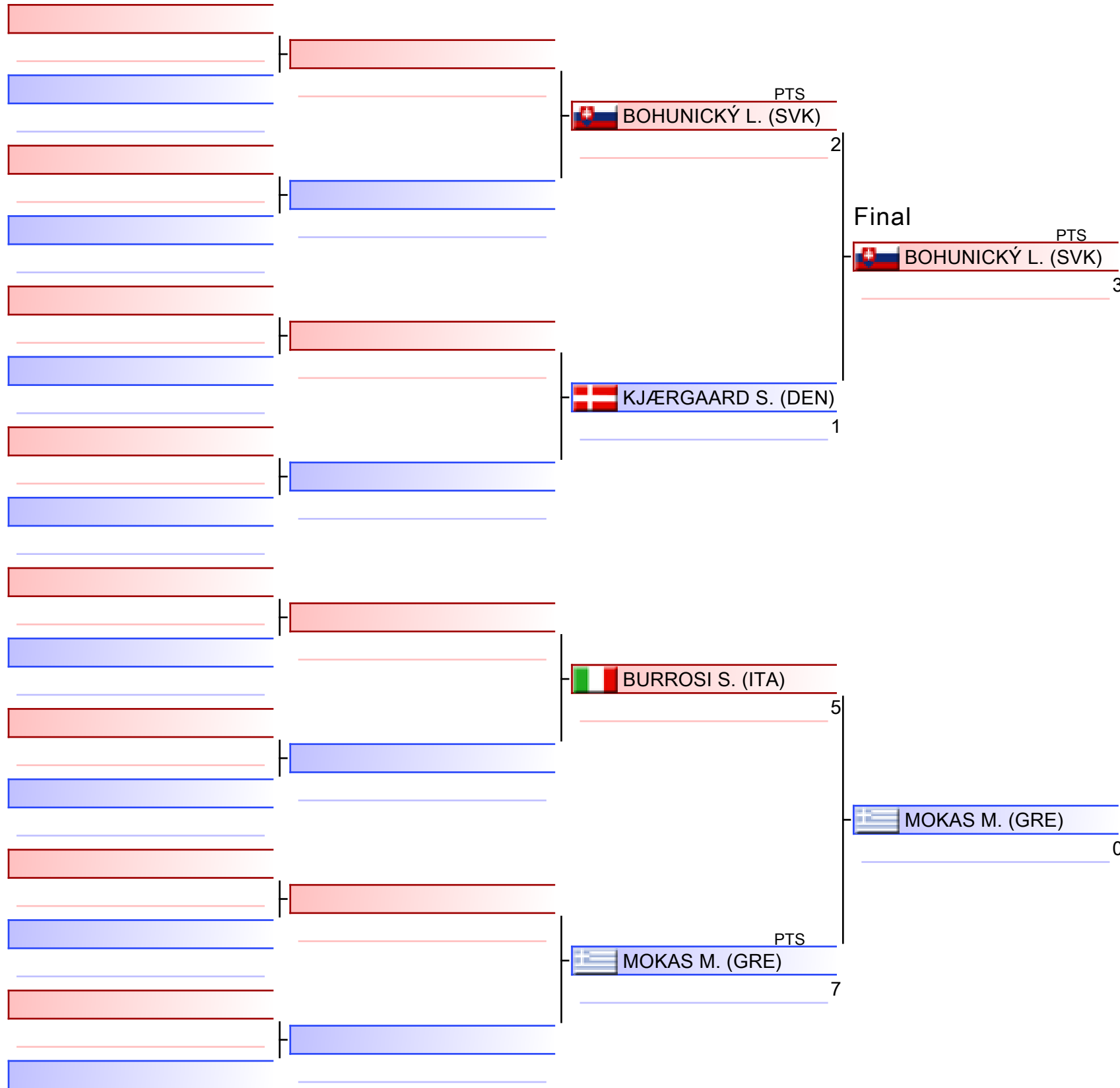

BOHUNICKÝ L. (SVK)

1. BOHUNICKÝ LUKÁŠ (SVK)
2. MOKAS MICHAEL (GRE)
3. SOTIROV BOJIDAR (BUL)
3. ANISIMOV VLADISLAV (BEL)
5. BURROSI SAMUELE (ITA)
5. KJÆRGAARD SIMON GRØNLUND (DEN)
7. KAMEL BASEM (NED)
7. SETIC TARIK (BIH)

Junior Kumite Male 76+ kg

Karate1 Youth League - Venice 2024

2024-12-06

Tatami
6 19:50

Pool
1,2

(c)sportdata GmbH & Co KG 2000-2024 (2024-12-08 20:16) v 10.2.0 build 1 (2024-11-20 00:58 CET) License: SDIL TVG (expire 2025-01-26)

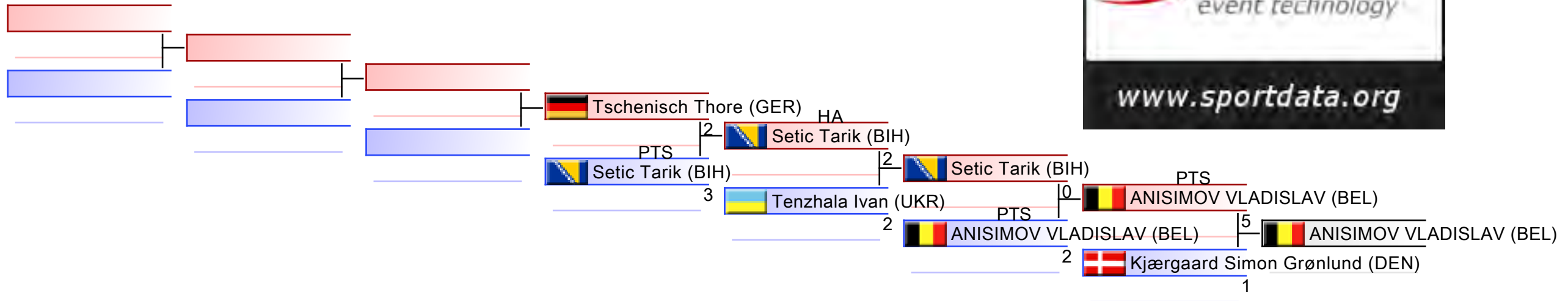

REPECHAGE: (1,2)

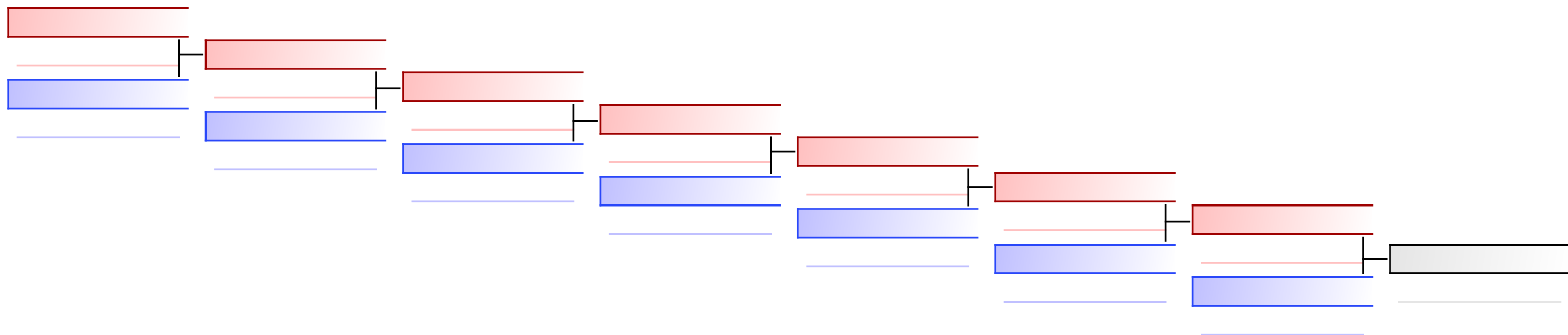

Junior Kumite Male 76+ kg

Karate1 Youth League - Venice 2024

2024-12-06

Tatami
8 19:50

Pool
3,4

(c)sportdata GmbH & Co KG 2000-2024 (2024-12-08 20:16) v 10.2.0 build 1 (2024-11-20 00:58 CET) License: SDIL TVG (expire 2025-01-26)

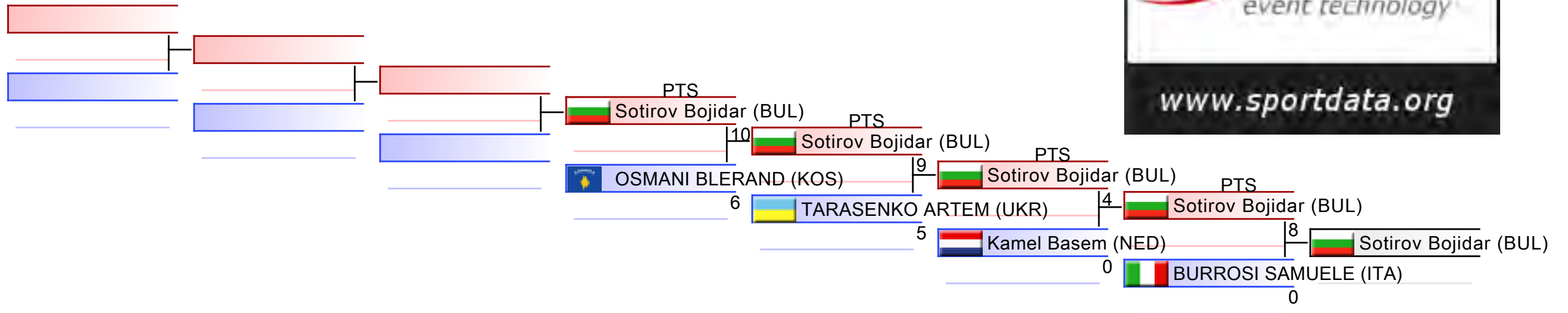

REPECHAGE: (3,4)

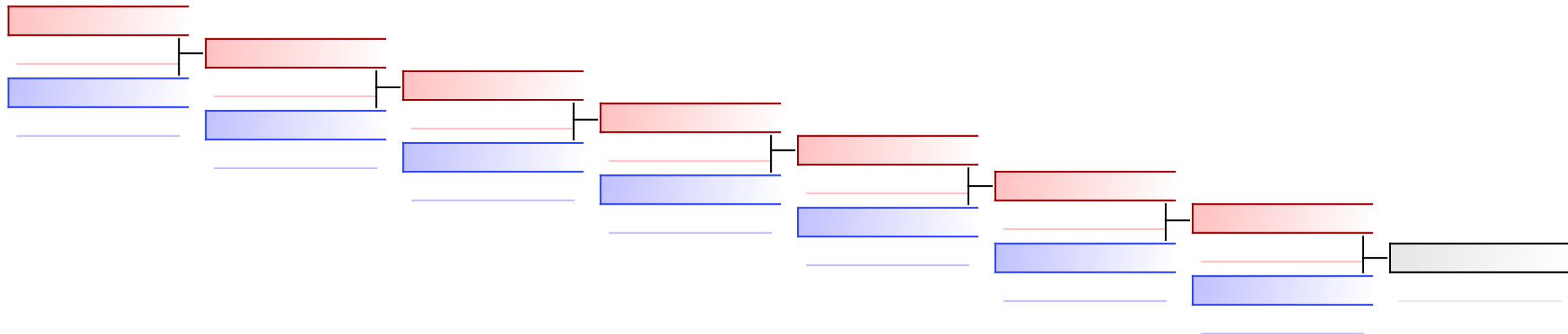



Karate1 Youth League - Venice 2024 - 2024-12-04



Official Results

Junior Kumite Male 76+ kg (Entries: 90 Nations: 32)			
1	BOHUNICKÝ LUKÁŠ		SVK - SLOVAKIA
2	MOKAS MICHAÏL		GRE - GREECE
3	SOTIROV BOJIDAR		BUL - BULGARIA
3	ANISIMOV VLADISLAV		BEL - BELGIUM
5	BURROSI SAMUELE		ITA - ITALY
5	KJÆRGAARD SIMON GRØNLUND		DEN - DENMARK
7	KAMEL BASEM		NED - NETHERLANDS
7	SETIC TARIK		BIH - BOSNIA AND HERZEGOVINA
9	TARASENKO ARTEM		UKR - UKRAINE
9	TENZHALA IVAN		UKR - UKRAINE
11	OSMANI BLERAND		KOS - KOSOVO
11	TSCHENISCH THORE		GER - GERMANY

U14 KATA FEMALE



Karate1 Youth League - Venice 2024

ENTRIES BY WEIGHT CATEGORY



U14 Kata Female

As of 8 DEC 2024

Country Code	ID	Gender	Name	Seeding
AUT		F	Schneeweiss Esther	
AUT		F	Strodl Sophie	
AUT		F	Treun Elena	
BIH		F	Alibalić Zara	
BIH		F	Azra Hadzic	
BIH		F	Babic Mila	
BIH		F	Bašagić Edna	
BIH		F	Smailovic Lejla	
BUL		F	Ivanova Deya	
CRO		F	ŠVIGLIN PAULA	
CRO		F	Validžić Čorić Leona	
CZE	CZE02892	F	PETRIKOVA NATHALIE	
EGY		F	Ahmed Jasmin	
ENG		F	Geraghty Jessica	
ENG		F	LANGHORN ELENA	
ENG		F	Sou Antonia	
ESP		F	Folgueira González Uxia	
ESP		F	PEÑA GARCIA CANDELA	
ESP		F	Quinto Gomez Luna	
FRA		F	DEFRANCE Inès	
FRA		F	Grenon Alyssa	
GER		F	Corbo Josefina	
GER		F	Hapfelmeier Louisa	
GER		F	Isejnoska Advija	
GER		F	Karadal Eda	
GER		F	Karadal Ela	
GER		F	Lampersberger Emilia	
GER		F	Lippert Helena	
GER	SD807896	F	Schaudig Luisa	
GER		F	Schulz Zoe	
GRE		F	VASILOPOULOU EMMANOUELA FOTEINI	
HUN		F	Benkő Nóra	
HUN		F	Husztly Zsuzsanna	
ITA		F	AMAGLIO GIULIA	
ITA		F	BERETTA MARTINA	
ITA		F	Carotenuto Floriana	
ITA		F	CECCHETTO LARA	
ITA		F	Copercini Margherita	
ITA		F	GOZZINI LUCREZIA	
ITA		F	GUALBERTI MELANIE	
ITA		F	HAMZA SARA	
ITA		F	IANNONE ANDREANA	
ITA		F	Novello Giada	
ITA		F	Paddeu Emma	
ITA		F	petruzzello sophie giorgia	



Karate1 Youth League - Venice 2024

ENTRIES BY WEIGHT CATEGORY



U14 Kata Female

As of 8 DEC 2024

Country Code	ID	Gender	Name	Seeding
ITA		F	PONZO MILAI	
ITA		F	QUARTERONI CARLA	
ITA		F	Rocchi Asia	
ITA		F	SIGISMONDI NOEMI	
ITA		F	Varva Anna	
ITA		F	Viacava Caterina	
JPN		F	OKAMOTO EMIRI	
JPN		F	SASAMOTO MOMONO	
LUX		F	Costa Nuria	
LUX		F	De Paiva Oceane	
LUX		F	Gomes Solara	
MDA	MDA002528	F	PUSCA EMILIA	
MLT	MLT02317	F	DIMECH DAWN	
MNE		F	Knežević Nađa	
POL	POL4091	F	KALLAS KAJA	
POL	POL10439	F	ONISHCHENKO ALISA	
POR		F	Cardoso Carolina	
POR		F	Cunha Sara	
ROU	ROU003868	F	ALEXIA VACAREAN	
ROU	ROU03599	F	GRIGORIU ARINA IOANA	
ROU	ROU003981	F	ILINKA DUMITRU	
ROU	ROU003982	F	INNA DUMITRU	
ROU	ROU003869	F	SARA STANCIU	
SLO	SLO02831	F	JERSIC ZANA	
SLO	SLO02564	F	MILJATOVIC ANDJELA	
SLO	SLO02570	F	PISNIK MAJA-MARI	
SRB		F	Djoković Mila	
SRB		F	Grujanić Irena	
SRB		F	Ivanovic Andrea	
SRB		F	Kopčok Mila	
SRB		F	Miladinović Kalina	
SRB		F	Šibinac Dunja	
SRB		F	Valašek Nađa	
SUI		F	Golubovic Inija	
SUI	SUI SD55986	F	Latsis Maria	
SVK		F	KLEMPOVÁ Laura	
SVK		F	Michalková Hannah	
TUR		F	AKTAŞ Aymin Ege	
TUR		F	BOZBEY YÜSRA	
TUR		F	TOPATAN CEYLA	
USA		F	Rashidi Lily	

U14 Kata Female

Karate1 Youth League - Venice 2024, PALAZZO DEL TURISMO, Piazza Brescia 11, 30016 Lido di Jesolo VE, ITA

2024-12-08

Tatami
1 09:00

Pool
1/4

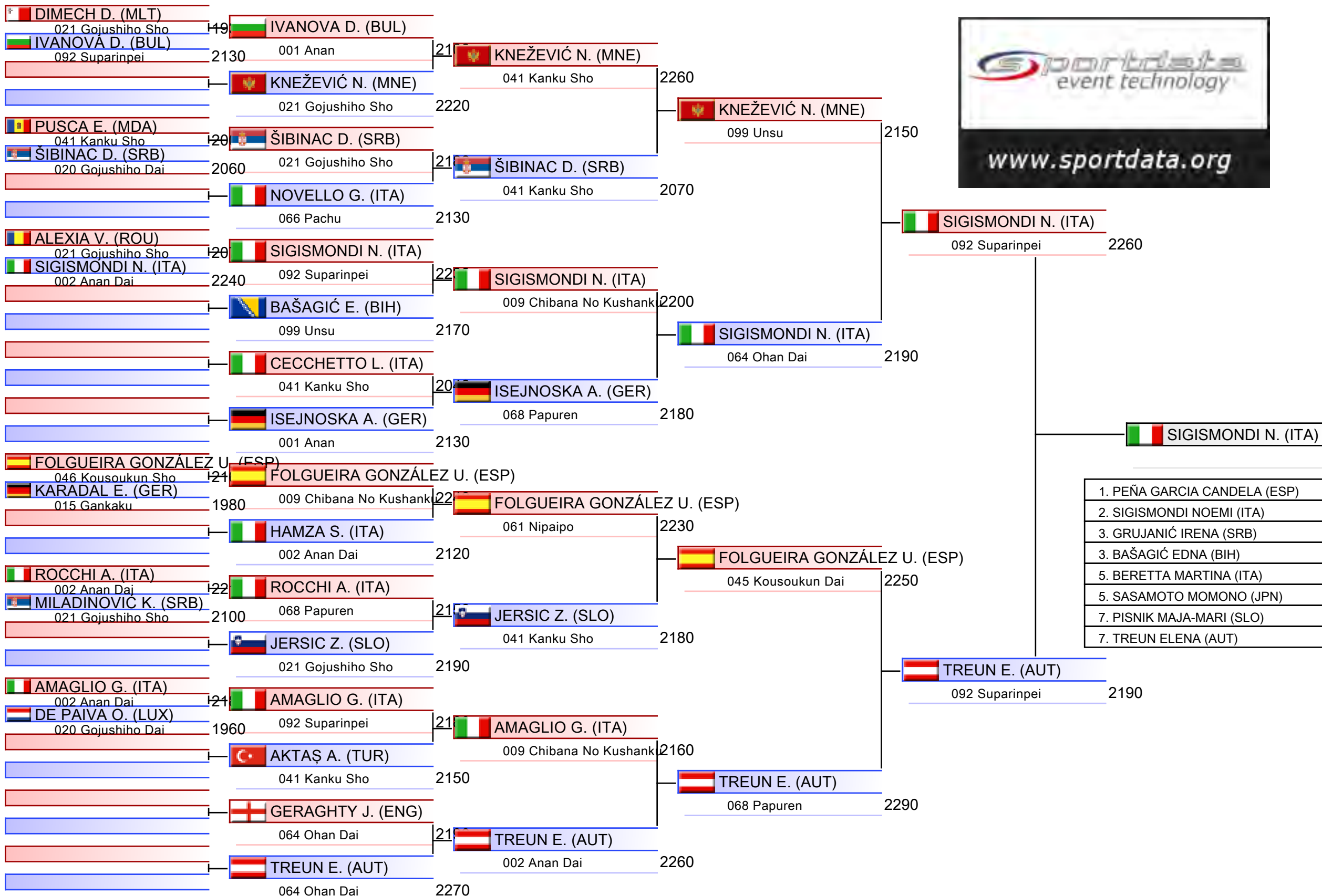

- | |
|------------------------------|
| 1. PEÑA GARCIA CANDELA (ESP) |
| 2. SIGISMONDI NOEMI (ITA) |
| 3. GRUJANIĆ IRENA (SRB) |
| 3. BAŠAGIĆ EDNA (BIH) |
| 5. BERETTA MARTINA (ITA) |
| 5. SASAMOTO MOMONO (JPN) |
| 7. PISNIK MAJA-MARI (SLO) |
| 7. TREUN ELENA (AUT) |

U14 Kata Female

Karate1 Youth League - Venice 2024, PALAZZO DEL TURISMO, Piazza Brescia 11, 30016 Lido di Jesolo VE, ITA

2024-12-08

Tatami
2 09:00

Pool
2/4

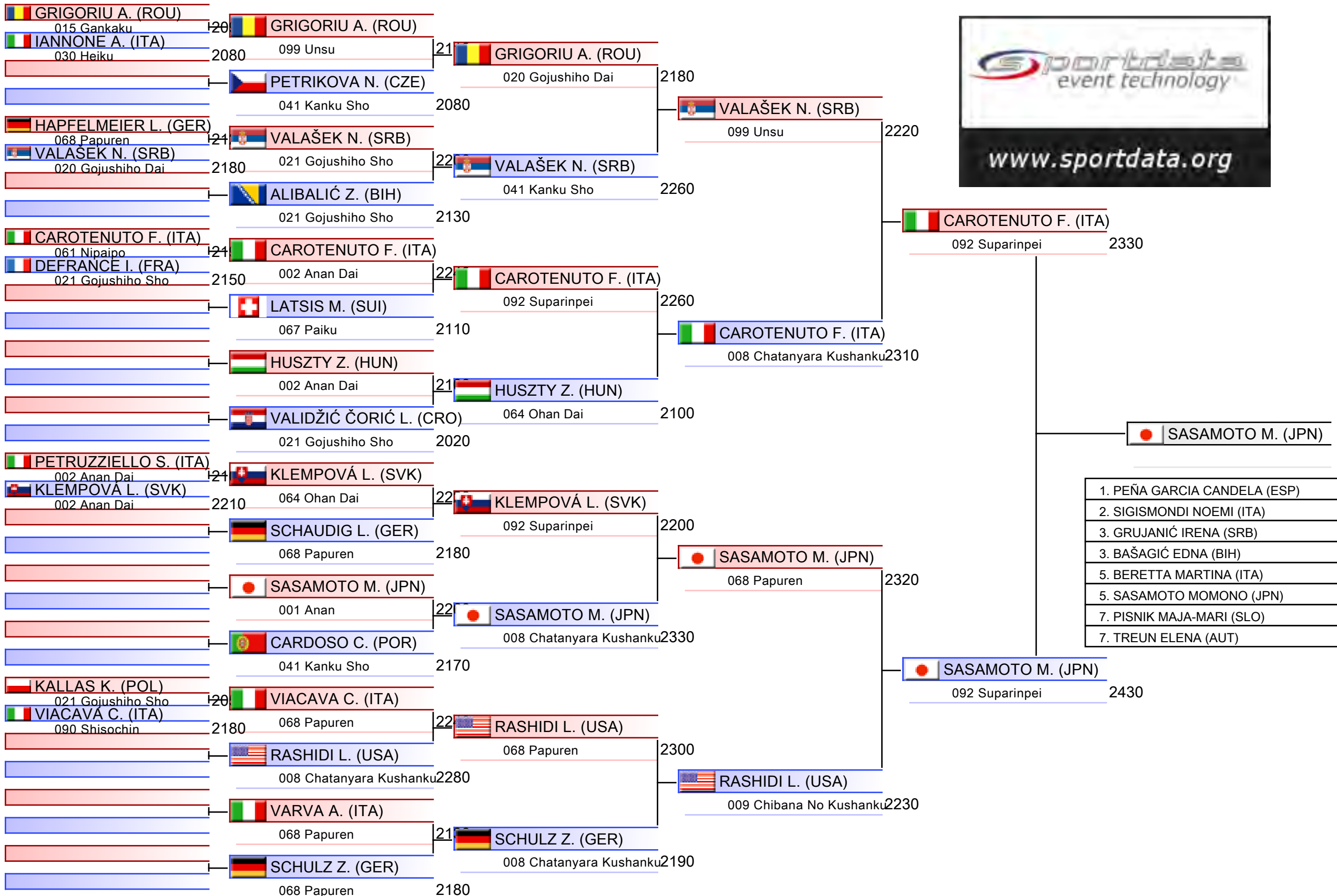

- | |
|------------------------------|
| 1. PEÑA GARCIA CANDELA (ESP) |
| 2. SIGISMONDI NOEMI (ITA) |
| 3. GRUJANIĆ IRENA (SRB) |
| 3. BAŠAGIĆ EDNA (BIH) |
| 5. BERETTA MARTINA (ITA) |
| 5. SASAMOTO MOMONO (JPN) |
| 7. PISNIK MAJA-MARI (SLO) |
| 7. TREUN ELENA (AUT) |

U14 Kata Female

Karate1 Youth League - Venice 2024, PALAZZO DEL TURISMO, Piazza Brescia 11, 30016 Lido di Jesolo VE, ITA

2024-12-08

Tatami
3 09:00

Pool
3/4

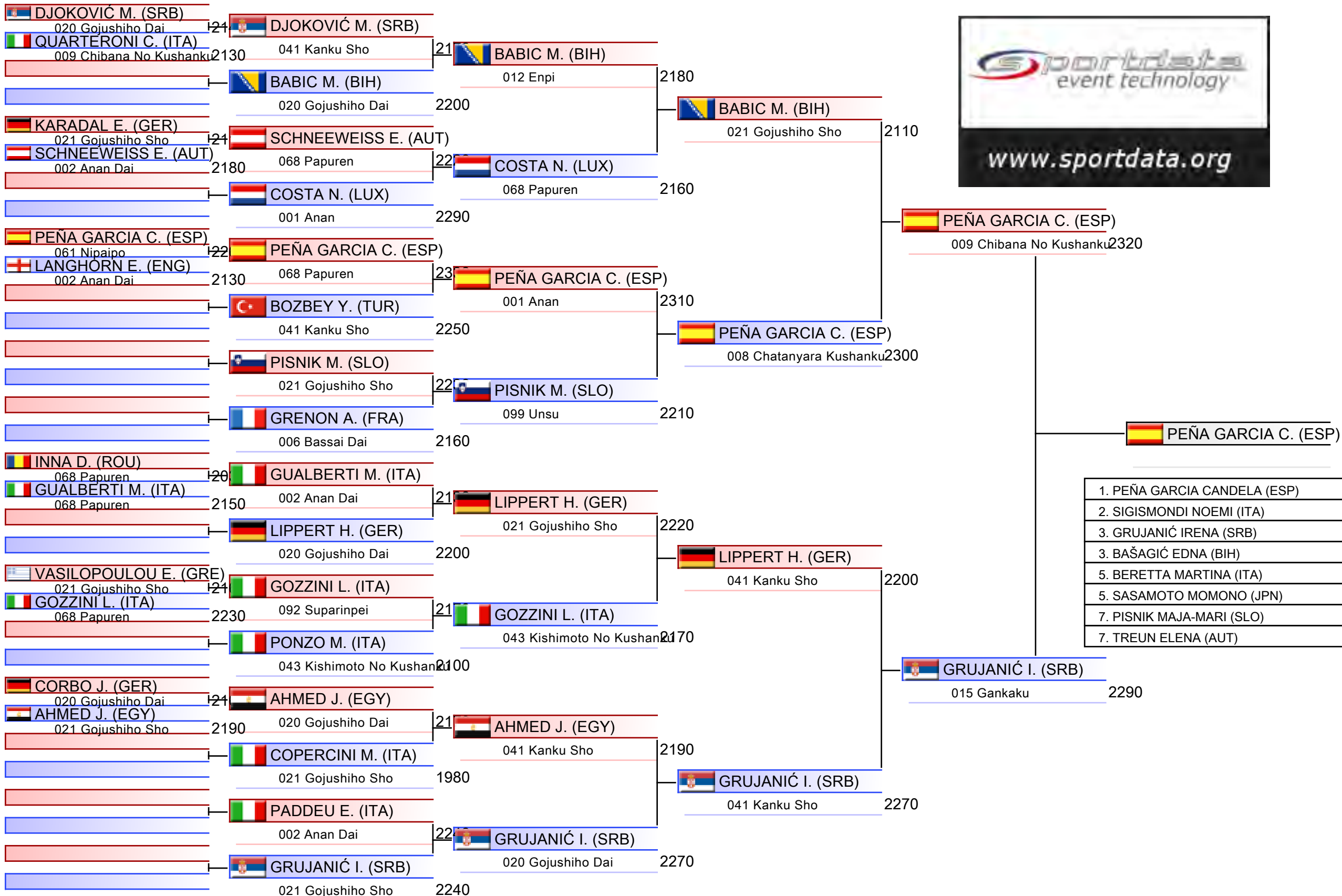

U14 Kata Female

Karate1 Youth League - Venice 2024, PALAZZO DEL TURISMO, Piazza Brescia 11, 30016 Lido di Jesolo VE, ITA

2024-12-08

Tatami
4 09:00

Pool
4/4

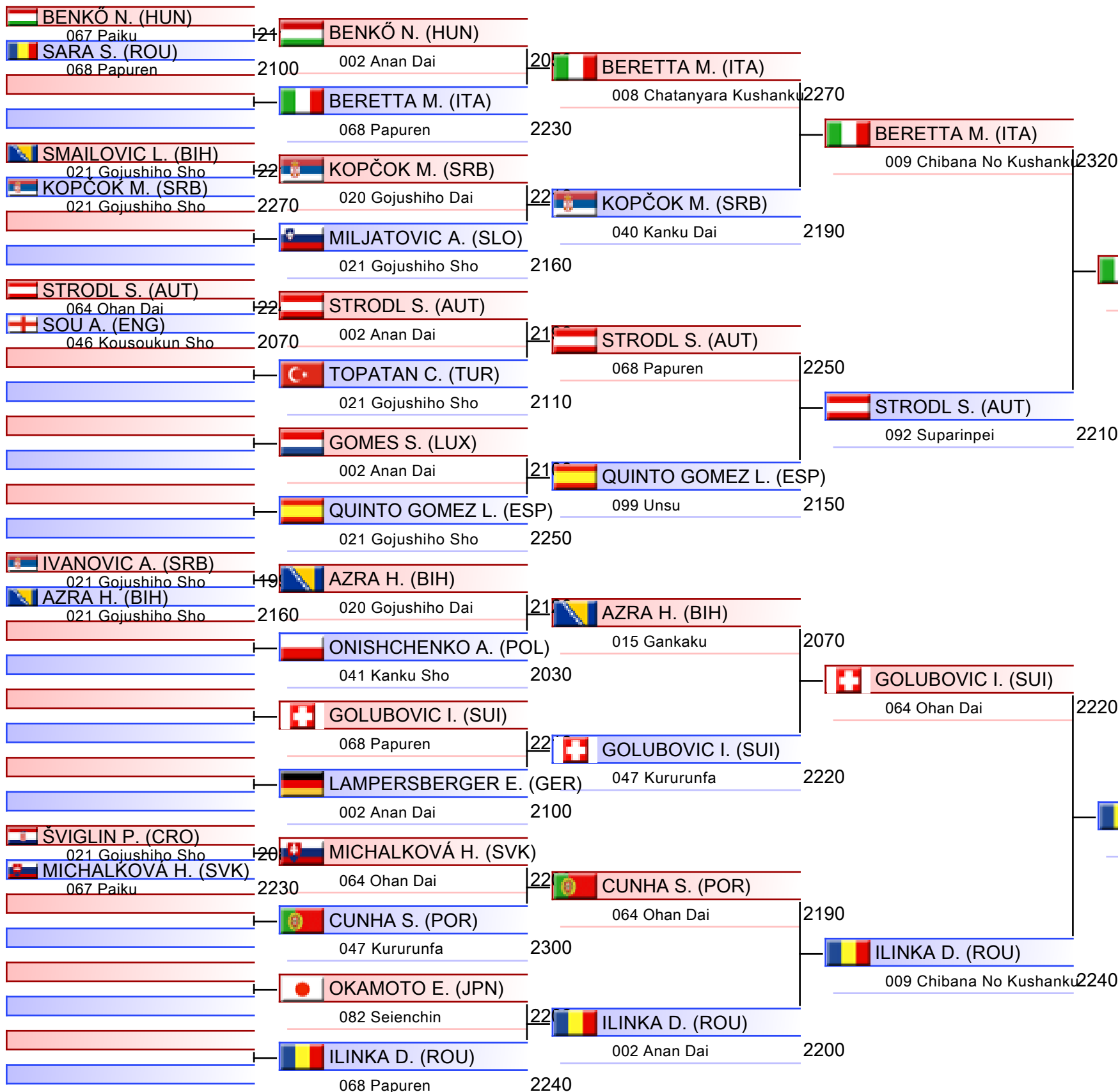

- | |
|------------------------------|
| 1. PEÑA GARCIA CANDELA (ESP) |
| 2. SIGISMONDI NOEMI (ITA) |
| 3. GRUJANIĆ IRENA (SRB) |
| 3. BAŠAGIĆ EDNA (BIH) |
| 5. BERETTA MARTINA (ITA) |
| 5. SASAMOTO MOMONO (JPN) |
| 7. PISNIK MAJA-MARI (SLO) |
| 7. TREUN ELENA (AUT) |

Pool winner-U14 Kata Female

Karate1 Youth League - Venice 2024, PALAZZO DEL TURISMO, Piazza Brescia 11, 30016 Lido di Jesolo VE, ITA

2024-12-08

Tatami
3 11:20

Pool
1/1

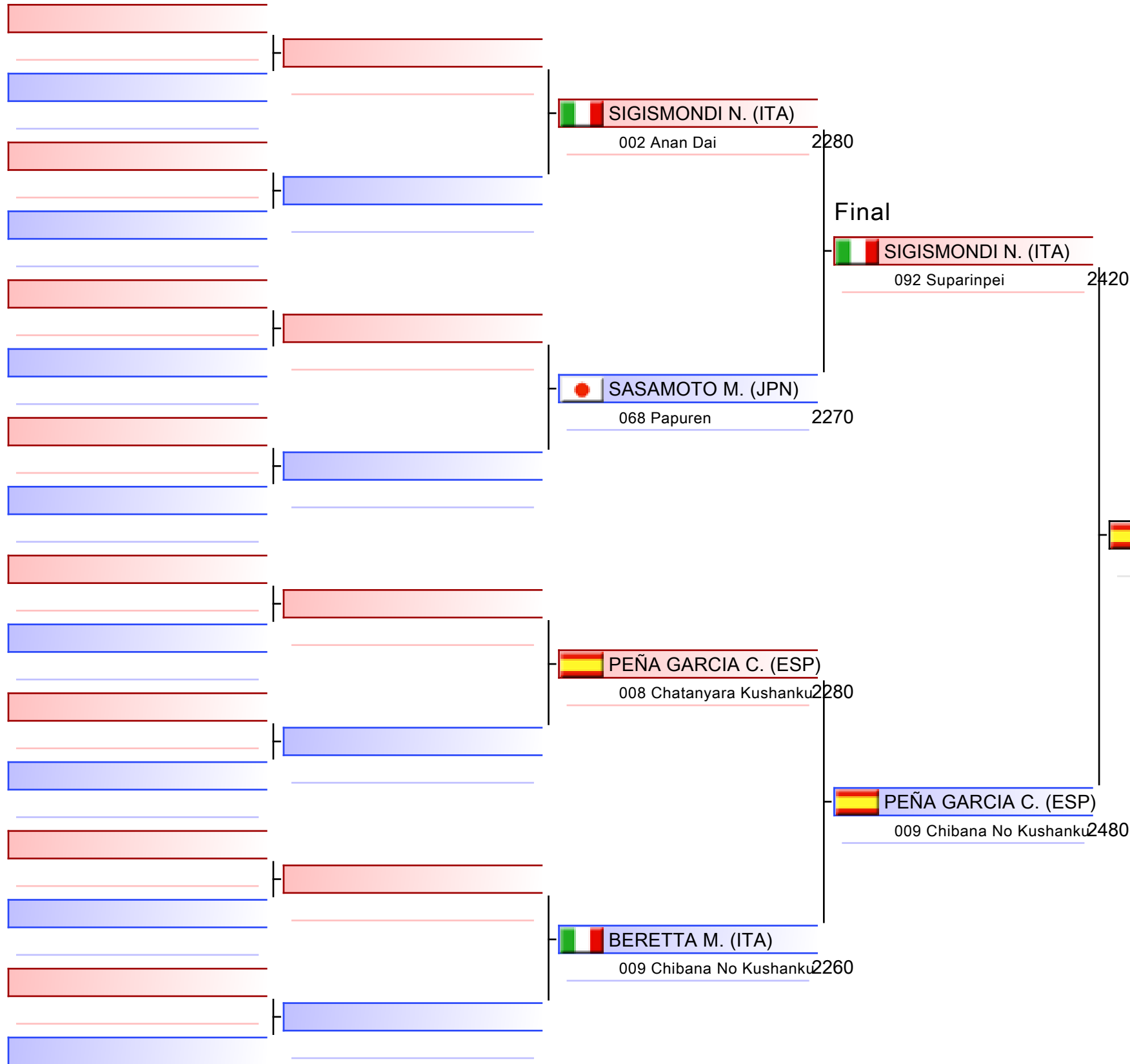

1. PEÑA GARCIA CANDELA (ESP)
2. SIGISMONDI NOEMI (ITA)
3. GRUJANIĆ IRENA (SRB)
3. BAŠAGIĆ EDNA (BIH)
5. BERETTA MARTINA (ITA)
5. SASAMOTO MOMONO (JPN)
7. PISNIK MAJA-MARI (SLO)
7. TREUN ELENA (AUT)

U14 Kata Female

Karate1 Youth League - Venice 2024

2024-12-08

Tatami

1 11:35

Pool

1,2

(c)sportdata GmbH & Co KG 2000-2024 (2024-12-08 20:16) v 10.2.0 build 1 (2024-11-20 00:58 CET) License: SDIL TVG (expire 2025-01-26)



REPECHAGE: (1,2)

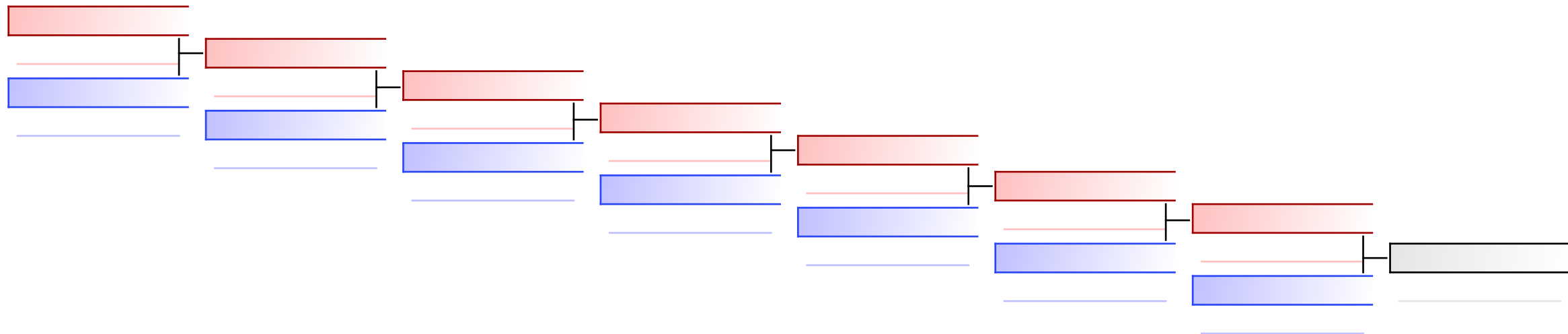

U14 Kata Female

Karate1 Youth League - Venice 2024

2024-12-08

Tatami

2 11:35

Pool

3,4

(c)sportdata GmbH & Co KG 2000-2024 (2024-12-08 20:16) v 10.2.0 build 1 (2024-11-20 00:58 CET) License: SDIL TVG (expire 2025-01-26)

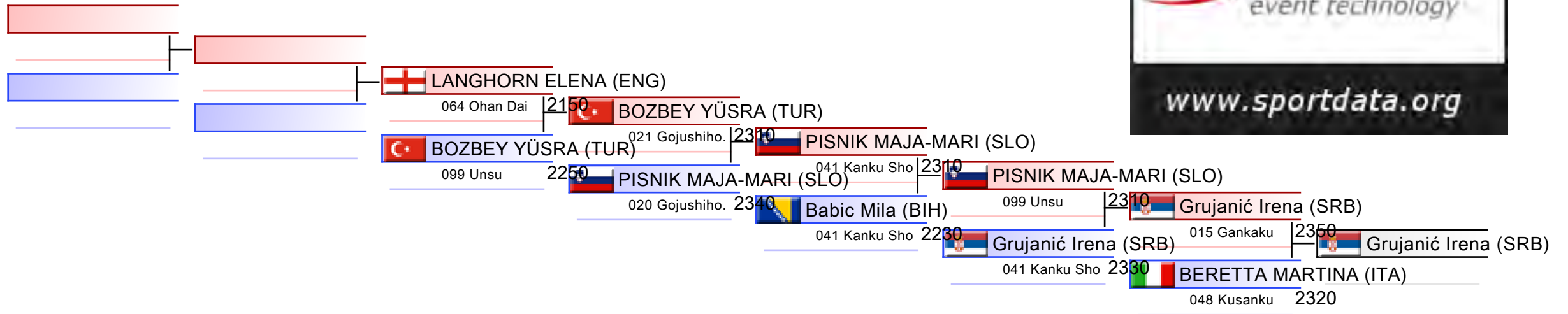

REPECHAGE: (3,4)

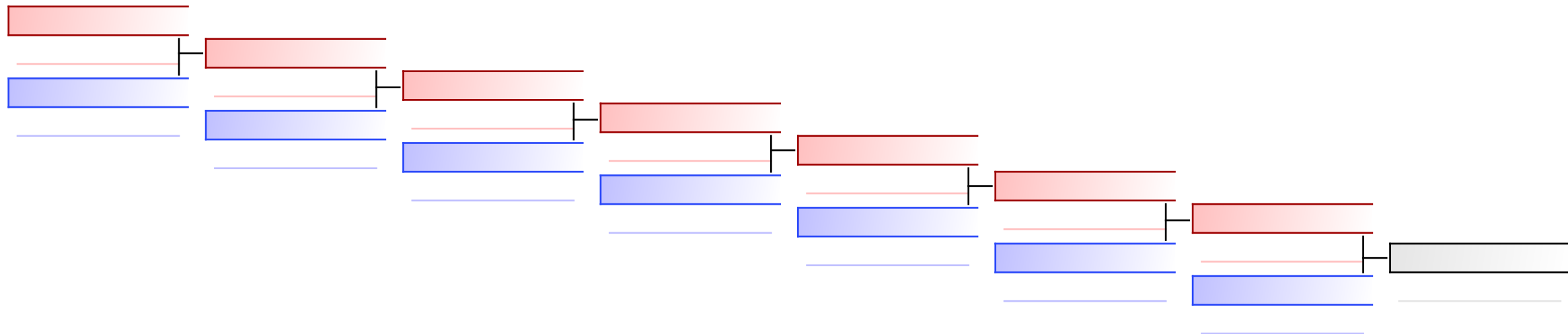



Karate1 Youth League - Venice 2024 - 2024-12-04



Official Results

U14 Kata Female (Entries: 86 Nations: 27)			
1	PEÑA GARCIA CANDELA		ESP - SPAIN
2	SIGISMONDI NOEMI		ITA - ITALY
3	GRUJANIĆ IRENA		SRB - SERBIA
3	BAŠAGIĆ EDNA		BIH - BOSNIA AND HERZEGOVINA
5	BERETTA MARTINA		ITA - ITALY
5	SASAMOTO MOMONO		JPN - JAPAN
7	PISNIK MAJA-MARI		SLO - SLOVENIA
7	TREUN ELENA		AUT - AUSTRIA
9	BABIC MILA		BIH - BOSNIA AND HERZEGOVINA
9	KNEŽEVIĆ NAĐA		MNE - MONTENEGRO
11	BOZBEY YÜSRA		TUR - TURKIYE
11	ISEJNOSKA ADVIJA		GER - GERMANY
13	LANGHORN ELENA		ENG - ENGLAND
13	ALEXIA VACAREAN		ROU - ROMANIA

U14 KATA MALE



Karate1 Youth League - Venice 2024

ENTRIES BY WEIGHT CATEGORY



U14 Kata Male

As of 8 DEC 2024

Country Code	ID	Gender	Name	Seeding
AUT	AUT02955	M	ZADINA EMIL	
BEL		M	Degée Louis	
BIH		M	MiskiĆ Elmin	
BIH		M	Šakinović Adnan	
BUL		M	Nikolov Nikola	
CAN		M	Boulianne Jayden	
CZE		M	Havrda Adam	
CZE		M	Koupal Martin	
CZE		M	Nedbal Vít	
ENG		M	Burden Jonny Rei	
ENG		M	Hopkins Freddie	
ENG		M	Jackson Fenn	
ENG		M	Oldekop Alex	
ENG		M	Spence Zac	
ESP		M	Gonzalez Hugo	
ESP		M	LLEÓ DE SMET JORGE	
ESP		M	Lopez Milan Mario	
ESP		M	MATHISON LION LEANDRO ANDRES	
ESP		M	Ramírez Rivas Adrian	
FIN		M	Wanic Mark	
FRA		M	Garcia Lamas Natan	
FRA		M	HART Enoha	
FRA		M	Nguyen Théodore	
GER		M	Athanassias Apostolos-Christos	
GER		M	Grasmeier Eric	
GER		M	Kuniyasu Shouta	
GER		M	Nikolaidis Ioannis	
GER		M	Schiefelbein Jonas	
GER		M	Theobald Phil	
GRE	GRE03030	M	KATECHIS ANGELOS LOUKAS	
GRE		M	VYTHOULKAS GEORGIOS	
ITA		M	Bon Edoardo	
ITA		M	BRUNI DAVIDE	
ITA	SD15400	M	Caraccia Filippo	
ITA		M	Corvaglia Simone	
ITA		M	D Auria Luca	
ITA		M	D'AUTORIO IGOR	
ITA	ITA484830	M	EZZA LEONARDO	
ITA		M	Giliberti Gianmarco	
ITA		M	Guzzetti Riccardo	
ITA		M	Marchetti Enrico	
ITA		M	Milano Nicola	
ITA		M	mocanu adrian nicolae	
ITA		M	MOLIN LUCA	
ITA		M	MURACCHIOLI LUCA	



Karate1 Youth League - Venice 2024

ENTRIES BY WEIGHT CATEGORY



U14 Kata Male

As of 8 DEC 2024

Country Code	ID	Gender	Name	Seeding
ITA		M	Narducci Nicolò	
ITA		M	Perini Thomas	
ITA		M	ROSSI Edoardo	
ITA		M	ZANET THOMAS	
MDA	MDA002532	M	STANU STANISLAV	
MNE	MNE0066368	M	Borovic Dusan	
MNE		M	Nikezić Tarik	
MNE		M	Popadić Miloš	
POL	POL2776	M	GOZDEK STEFAN	
POL	POL10839	M	LEBEDIANSKYI DMITRO	
POL	POL10316	M	Ostrowski Mateusz	
POR		M	Durão Francisco	
POR		M	Oliveira Rodrigo	
POR		M	Rocha Gonçalo	
ROU	ROU003983	M	DARIUS IONECI	
ROU	ROU03600	M	MARIA CEZAR	
ROU	ROU003978	M	PETRU STAICU CALINESCU	
ROU	ROU003977	M	RADU ANDREI RUSU	
SLO	SLO02941	M	KRAMAR VILI	
SRB		M	Greb Andrija	
SRB		M	Jevremovic Svetislav	
SUI		M	Iseppi Nevio	
SVK		M	BABEL Branislav	
SVK		M	Bugan Leo	
SVK		M	Gendes Juraj	
SVK		M	VERCIMAK MARTIN	
TKM	TKM02328	M	SAPADURDYEV OVEZMYRAT	
TUR		M	Naimoğlu Melih Tark	
UKR		M	Bilous Illia	
UKR		M	MARCHENKO OLEKSII	
UKR		M	RUDENKO KLYMENTII	
UKR		M	Yemeljanov Maksym	
USA		M	Bonetti Akiau Luigi	
VEN		M	Muga Shamuel	
VEN		M	TORRES FIGUEROA JUAN ALFONSO	
WAL		M	Lewis Caian	

U14 Kata Male

Karate1 Youth League - Venice 2024, PALAZZO DEL TURISMO, Piazza Brescia 11, 30016 Lido di Jesolo VE, ITA

2024-12-08

Tatami
5 09:00

Pool
1/4

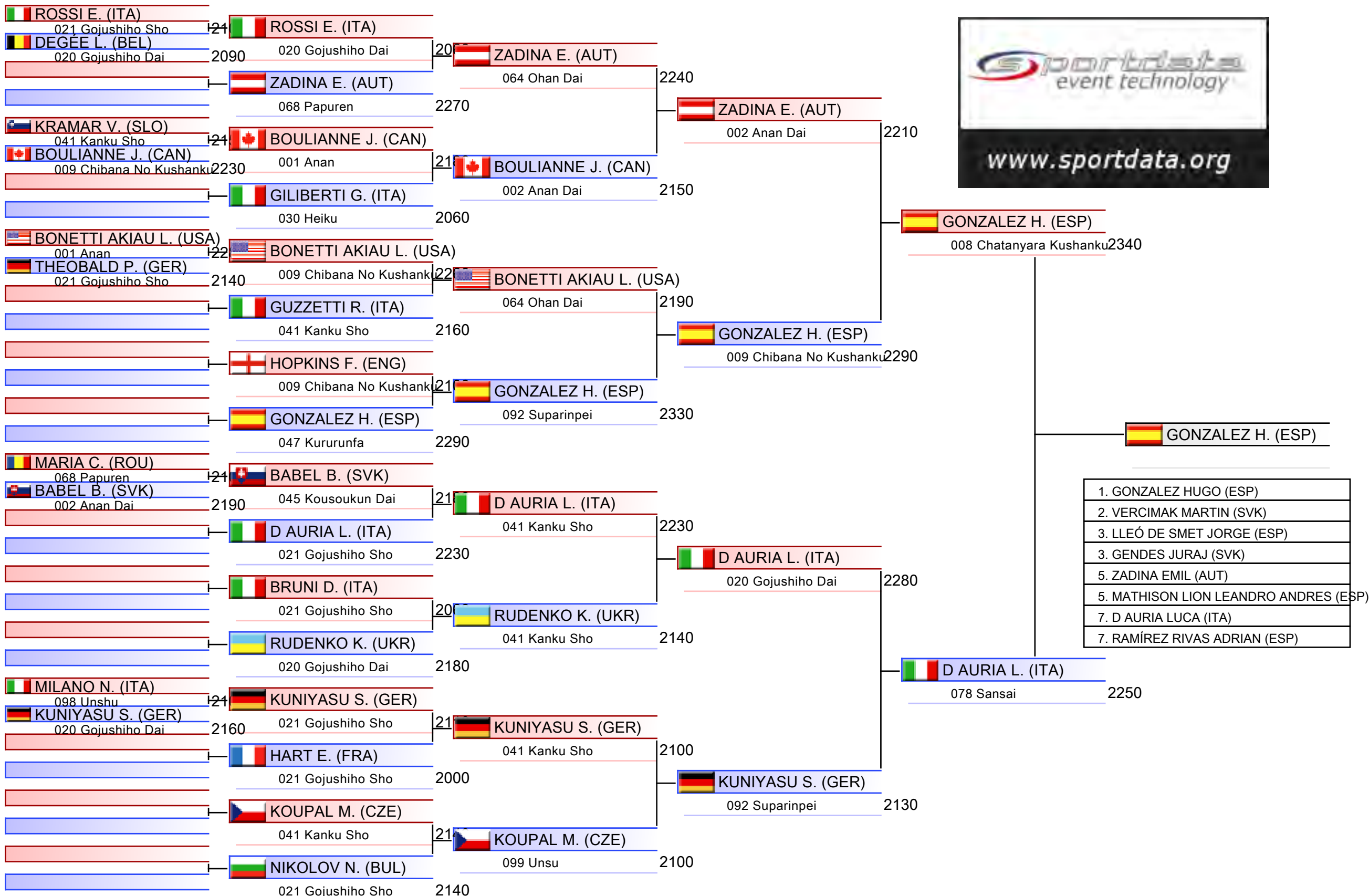

U14 Kata Male

Karate1 Youth League - Venice 2024, PALAZZO DEL TURISMO, Piazza Brescia 11, 30016 Lido di Jesolo VE, ITA

2024-12-08

Tatami
6 09:00

Pool
2/4

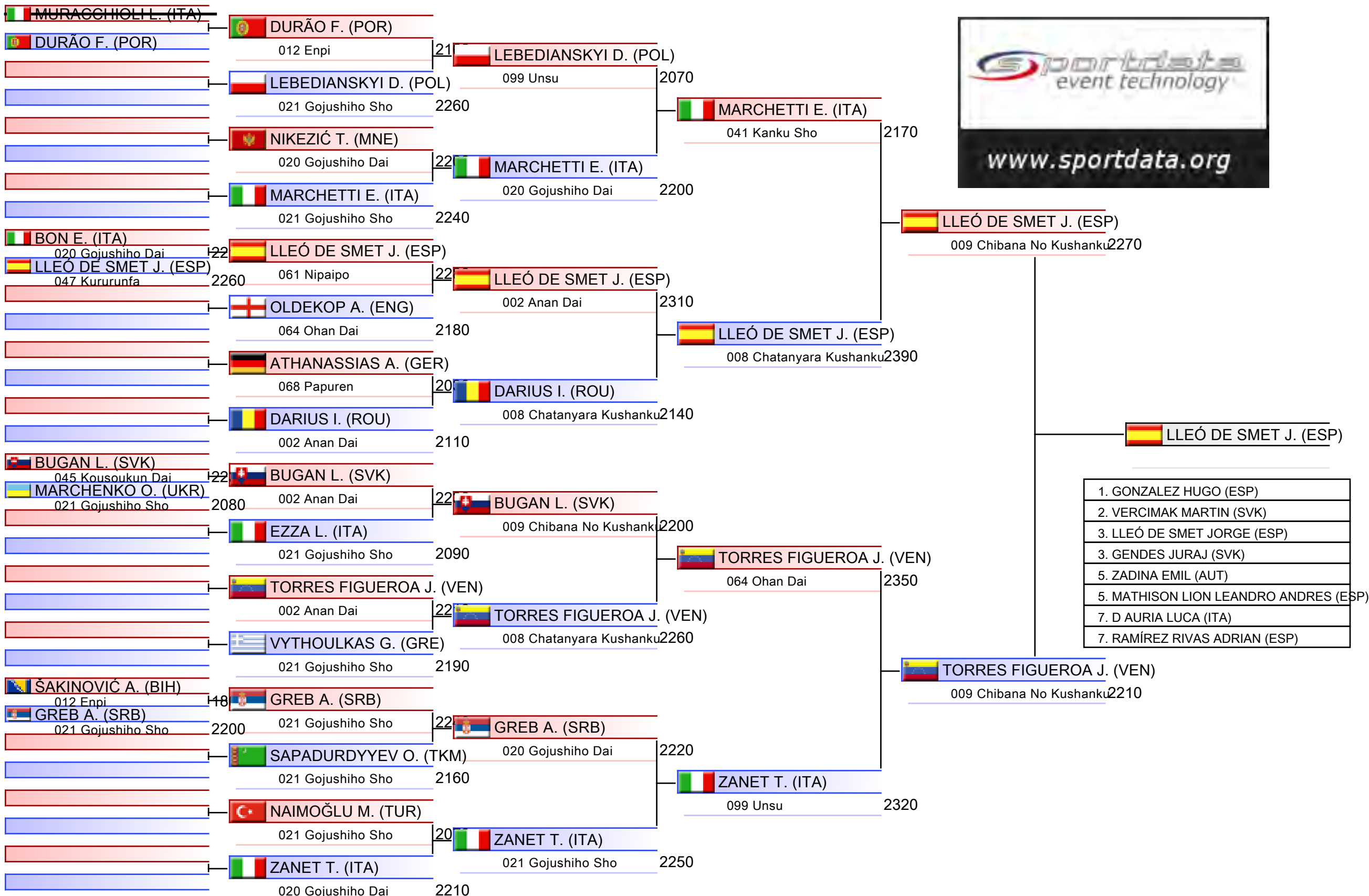

- | |
|---------------------------------------|
| 1. GONZALEZ HUGO (ESP) |
| 2. VERCIMAK MARTIN (SVK) |
| 3. LLEÓ DE SMET JORGE (ESP) |
| 3. GENDES JURAJ (SVK) |
| 5. ZADINA EMIL (AUT) |
| 5. MATHISON LION LEANDRO ANDRES (ESP) |
| 7. D AURIA LUCA (ITA) |
| 7. RAMÍREZ RIVAS ADRIAN (ESP) |

U14 Kata Male

Karate1 Youth League - Venice 2024, PALAZZO DEL TURISMO, Piazza Brescia 11, 30016 Lido di Jesolo VE, ITA

2024-12-08

Tatami
7 09:00

Pool
3/4

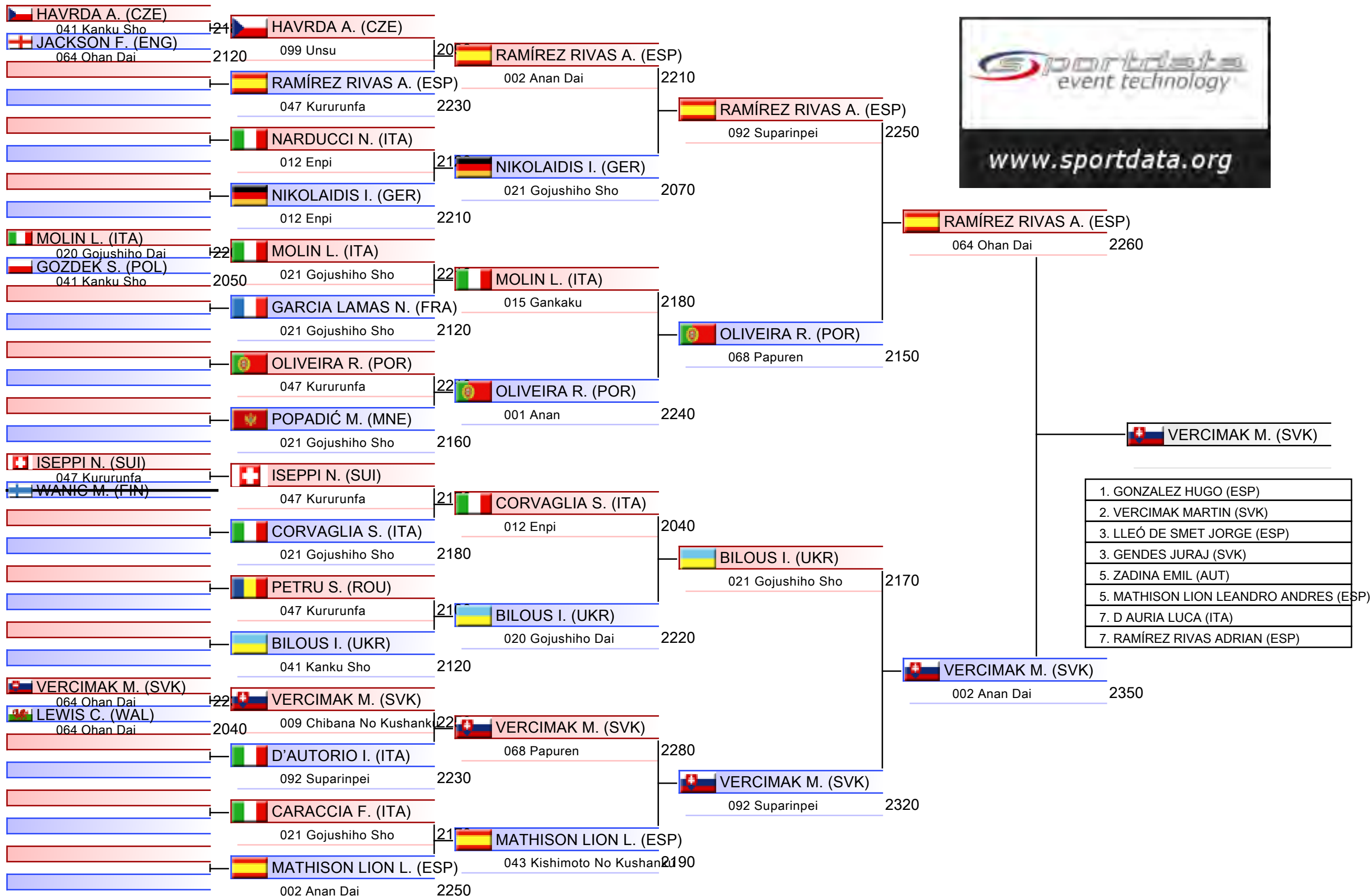

- | |
|---------------------------------------|
| 1. GONZALEZ HUGO (ESP) |
| 2. VERCIMAK MARTIN (SVK) |
| 3. LLEÓ DE SMET JORGE (ESP) |
| 3. GENDES JURAJ (SVK) |
| 5. ZADINA EMIL (AUT) |
| 5. MATHISON LION LEANDRO ANDRES (ESP) |
| 7. D AURIA LUCA (ITA) |
| 7. RAMÍREZ RIVAS ADRIAN (ESP) |

U14 Kata Male

Karate1 Youth League - Venice 2024, PALAZZO DEL TURISMO, Piazza Brescia 11, 30016 Lido di Jesolo VE, ITA

2024-12-08

Tatami
8 09:00

Pool
4/4

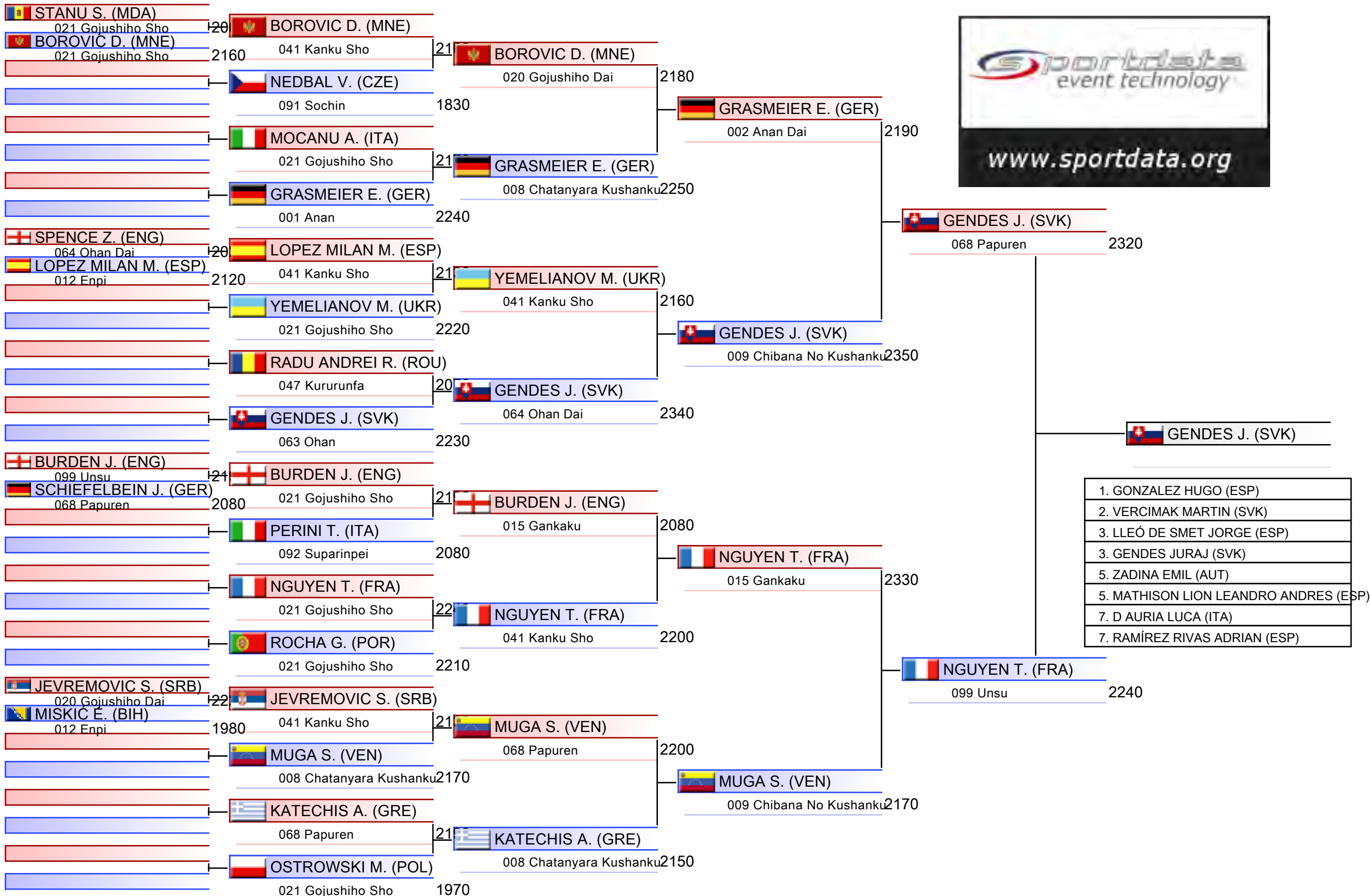

Pool winner-U14 Kata Male

Karate1 Youth League - Venice 2024, PALAZZO DEL TURISMO, Piazza Brescia 11, 30016 Lido di Jesolo VE, ITA

2024-12-08

Tatami

5 11:15

Pool

1/1

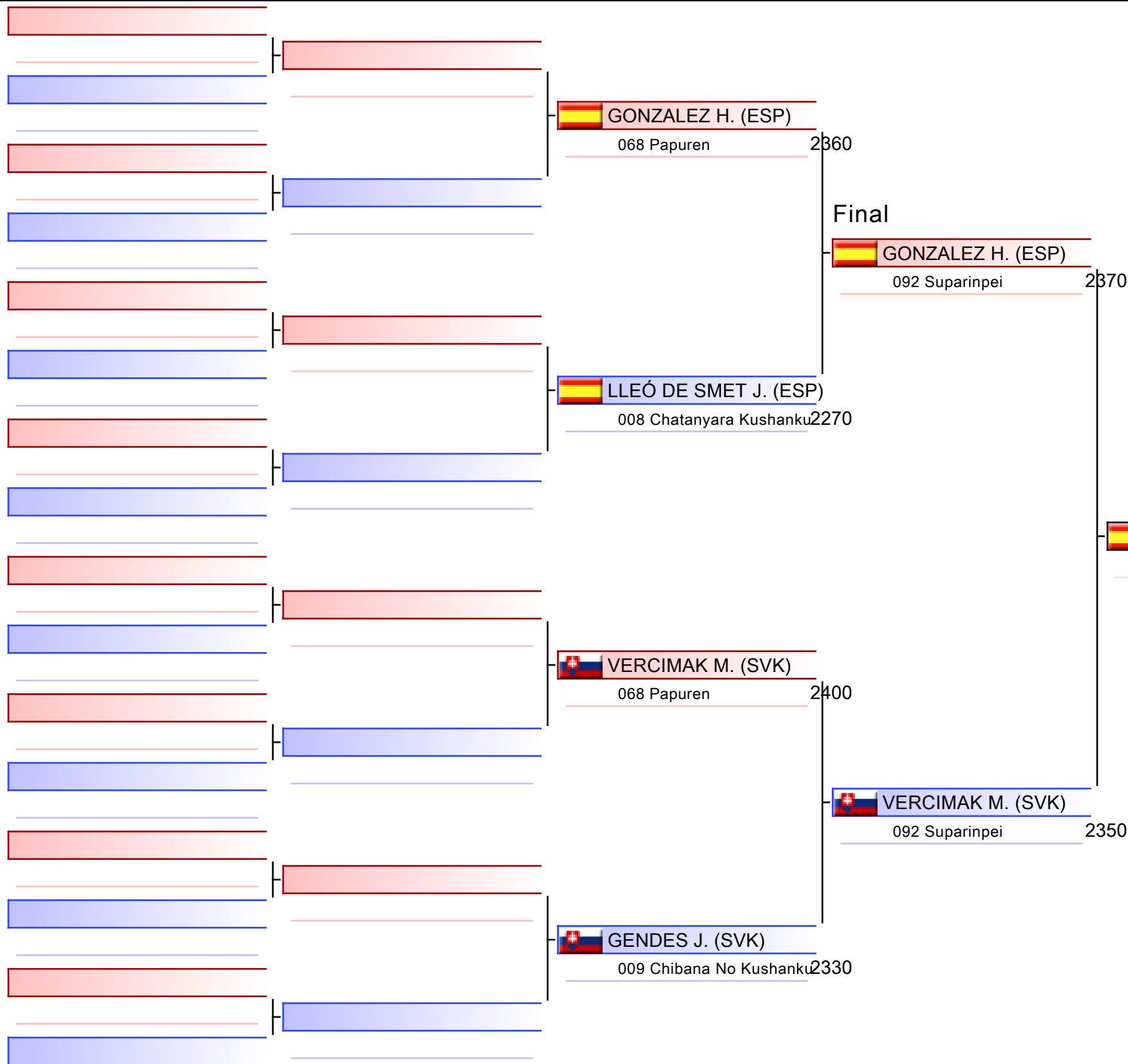

1. GONZALEZ HUGO (ESP)
2. VERCIMAK MARTIN (SVK)
3. LLEÓ DE SMET JORGE (ESP)
3. GENDES JURAJ (SVK)
5. ZADINA EMIL (AUT)
5. MATHISON LION LEANDRO ANDRES (ESP)
7. D AURIA LUCA (ITA)
7. RAMÍREZ RIVAS ADRIAN (ESP)

U14 Kata Male

Karate1 Youth League - Venice 2024

2024-12-08

Tatami

3 11:35

Pool

1,2

(c)sportdata GmbH & Co KG 2000-2024 (2024-12-08 20:16) v 10.2.0 build 1 (2024-11-20 00:58 CET) License: SDIL TVG (expire 2025-01-26)

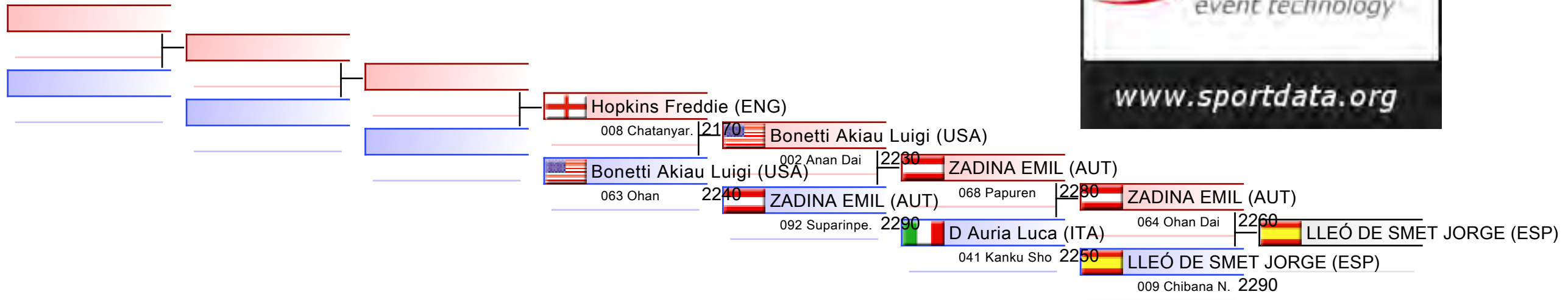

REPECHAGE: (1,2)

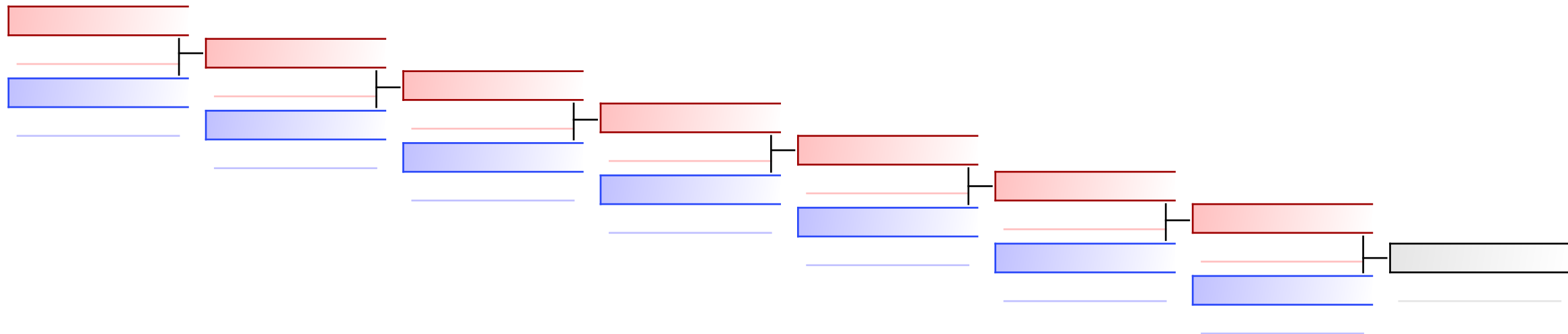

U14 Kata Male

Karate1 Youth League - Venice 2024

2024-12-08

Tatami

4 11:35

Pool

3,4

(c)sportdata GmbH & Co KG 2000-2024 (2024-12-08 20:16) v 10.2.0 build 1 (2024-11-20 00:58 CET) License: SDIL TVG (expire 2025-01-26)

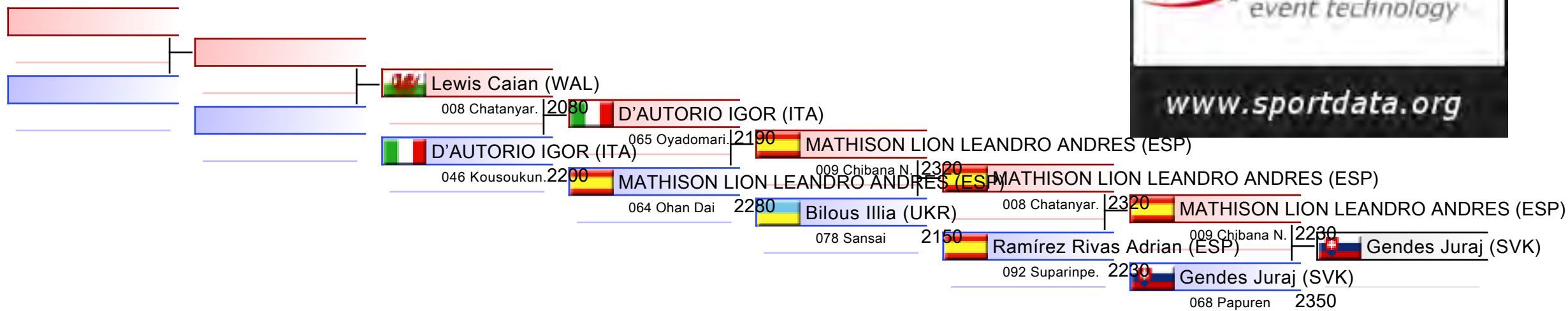

REPECHAGE: (3,4)

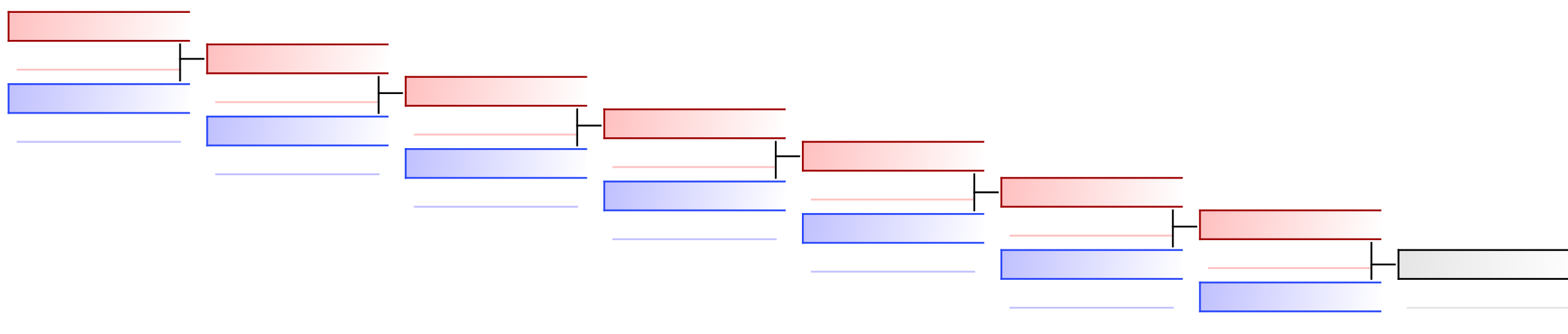



Karate1 Youth League - Venice 2024 - 2024-12-04



Official Results

U14 Kata Male (Entries: 81 Nations: 28)			
1	GONZALEZ HUGO		ESP - SPAIN
2	VERCIMAK MARTIN		SVK - SLOVAKIA
3	LLEÓ DE SMET JORGE		ESP - SPAIN
3	GENDES JURAJ		SVK - SLOVAKIA
5	ZADINA EMIL		AUT - AUSTRIA
5	MATHISON LION LEANDRO ANDRES		ESP - SPAIN
7	D AURIA LUCA		ITA - ITALY
7	RAMÍREZ RIVAS ADRIAN		ESP - SPAIN
9	BONETTI AKIAU LUIGI		USA - UNITED STATES
9	BILOUS ILLIA		UKR - UKRAINE
11	HOPKINS FREDDIE		ENG - ENGLAND
11	D'AUTORIO IGOR		ITA - ITALY
13	LEWIS CAIAN		WAL - WALES

U14 KUMITE FEMALE -42 KG



Karate1 Youth League - Venice 2024

ENTRIES BY WEIGHT CATEGORY



U14 Kumite Female -42 kg

As of 8 DEC 2024

Country Code	ID	Gender	Name	Seeding
BEL		F	Dujardin Eva	
BEL		F	Hibrahimi Yasmine	
BIH		F	Arnautović Zahra	
BIH		F	Azra Hadzic	
BUL		F	Yordanova Andrea	
CAN		F	Singh Adelaide	
CRO		F	Adžamić Tena	
CRO		F	Čebuhar Fani	
CRO		F	Kasumovic Natalia	
CRO		F	Kincl Nina	
CRO		F	Ribar Katarina	
CRO		F	Schubert Dora	
CRO		F	Šćurić Lucija	
CYP		F	STYLIANOU KALIA	
CZE		F	HORŇÁKOVÁ Sofie	
EGY	EGY04475	F	ZAKI Iamar	
ENG		F	Stoddart Hannah	
FRA		F	DUPUIS PARSY Ines	
FRA		F	Gouy Louison	
FRA		F	SAIDI Jasmine	
GER		F	Baumgärtner Lena	
GER		F	Safi Dania	
GER		F	Wierzbicki Evelyn	
GRE	GRE03520	F	NANNOU AIKATERINI	
GRE	GRE03079	F	TRIANAFYLLI FAIDRA	
GRE		F	VASILOPOULOU EMMANOUELA FOTEINI	
HUN		F	Arnóth Lilla Johanna	
IND		F	Ramesh Nakshatra Ira	
IRI		F	Farzin Mahdis	
ITA		F	ANGHEL ARIANNA ANDREEA	
ITA		F	arena benedetta	
ITA		F	Brotto Viola Germana	
ITA		F	CAMPO ARIANNA	
ITA		F	CAPECE GINEVRA OLIMPIA	
ITA		F	Cavallaro Lara	
ITA		F	De Marchi Ludovica	
ITA		F	Martini Alice	
ITA		F	NEGRONE VIVIANA	
ITA		F	Reineri Olimpia	
ITA		F	Rizzi Ariani Maria	
ITA		F	Sangeorzan Mirabella	
ITA		F	Santori Vittoria	
ITA		F	Simone Sofia	
ITA		F	SPATTI ALICE	
ITA		F	Stramare Ilaria	



Karate1 Youth League - Venice 2024
ENTRIES BY WEIGHT CATEGORY



U14 Kumite Female -42 kg
As of 8 DEC 2024

Country Code	ID	Gender	Name	Seeding
ITA		F	Veronese Matilda	
KOS	KOS03356	F	BILALLI TUANA	
KOS	KOS03336	F	HASANAJ KLEA	
LAT		F	Nikonova Arina	
LUX		F	Ei Meskiri Lena	
MDA	MDA002525	F	CERNEI SOFIA	
NOR		F	Hansen Celine Marie Walstad	
POL	POL4091	F	KALLAS KAJA	
POR		F	Cardoso Carolina	
ROU	ROU003860	F	LARISA GHITA	
ROU	ROU003980	F	NATALIA CIUTACU	
ROU	ROU003975	F	SARA NASTAS	
ROU	ROU03227	F	URIAN RALUCA	
SRB		F	Četnik Sofija	
SRB		F	Jakić Andrea	
SRB		F	Jakić Nina	
SRB		F	Krstin Elena	
SRB		F	Martac Sofija	
SRB		F	Petrović Ružica	
SVK		F	Bírová Emma	
SVK		F	Černáková Olivia	
SVK		F	Viglašská Viktória	
SWE		F	Erhardt Signe	
TUR		F	KILINÇ KÜBRA	
TUR		F	KOCAKAPLAN NURAHSEN	
TUR		F	YILDIRIM LEYLANUR	
UKR		F	Anufriieva Rimma	
UKR		F	Astapova Darina	
UKR		F	HAIDUK YANA	
UKR		F	KHOLOD YEVA	
UKR		F	Koliada Marharyta	
UKR		F	Krapivna Anastasiia	
UKR		F	PRYNDIUK ANASTASIIA	

U14 Kumite Female -42 kg

Karate1 Youth League - Venice 2024, PALAZZO DEL TURISMO, Piazza Brescia 11, 30016 Lido di Jesolo VE, ITA

2024-12-07

Tatami
1 18:30

Pool
1/4

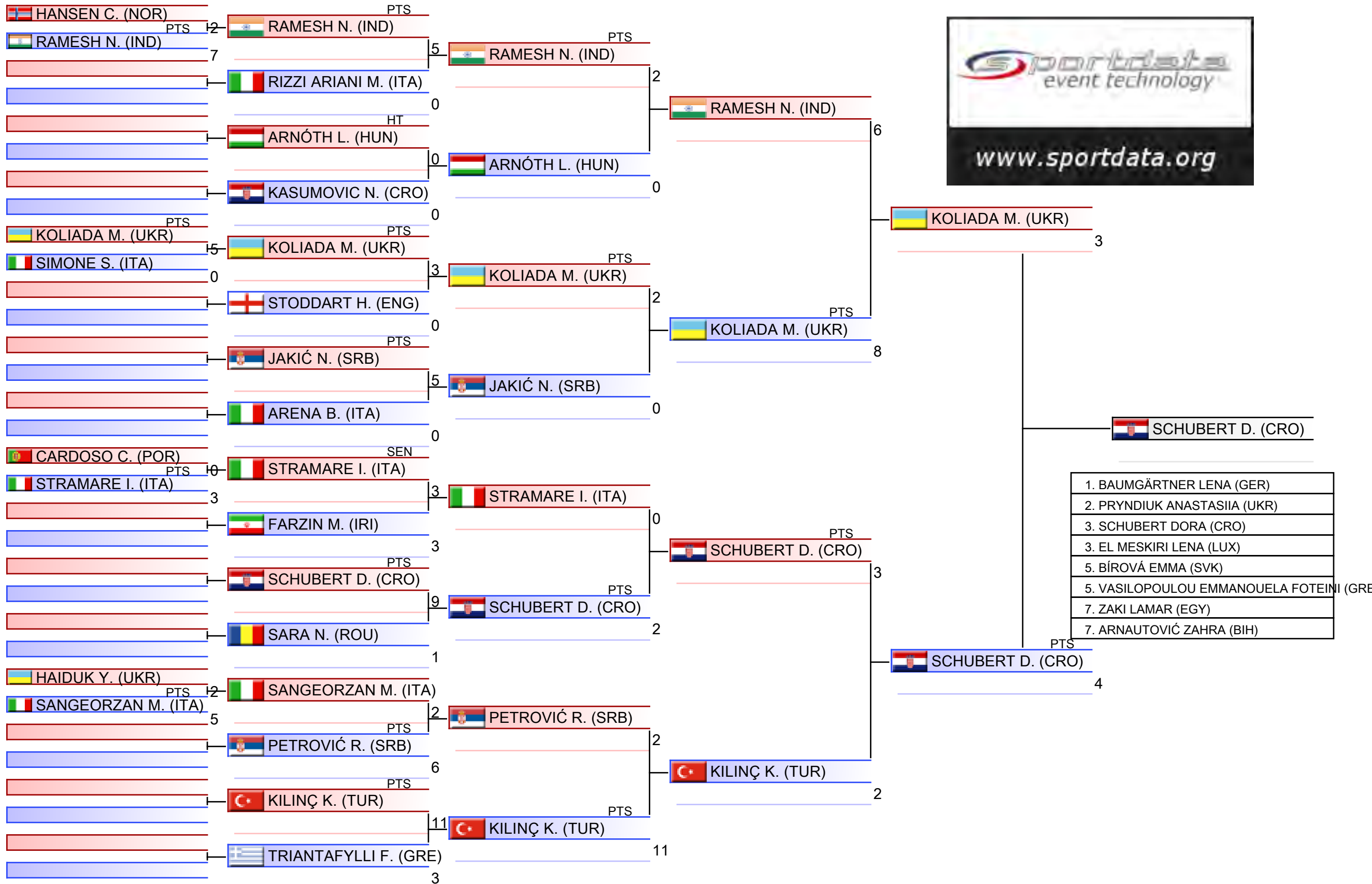

U14 Kumite Female -42 kg

Karate1 Youth League - Venice 2024, PALAZZO DEL TURISMO, Piazza Brescia 11, 30016 Lido di Jesolo VE, ITA

2024-12-07

Tatami
2 18:30

Pool
2/4

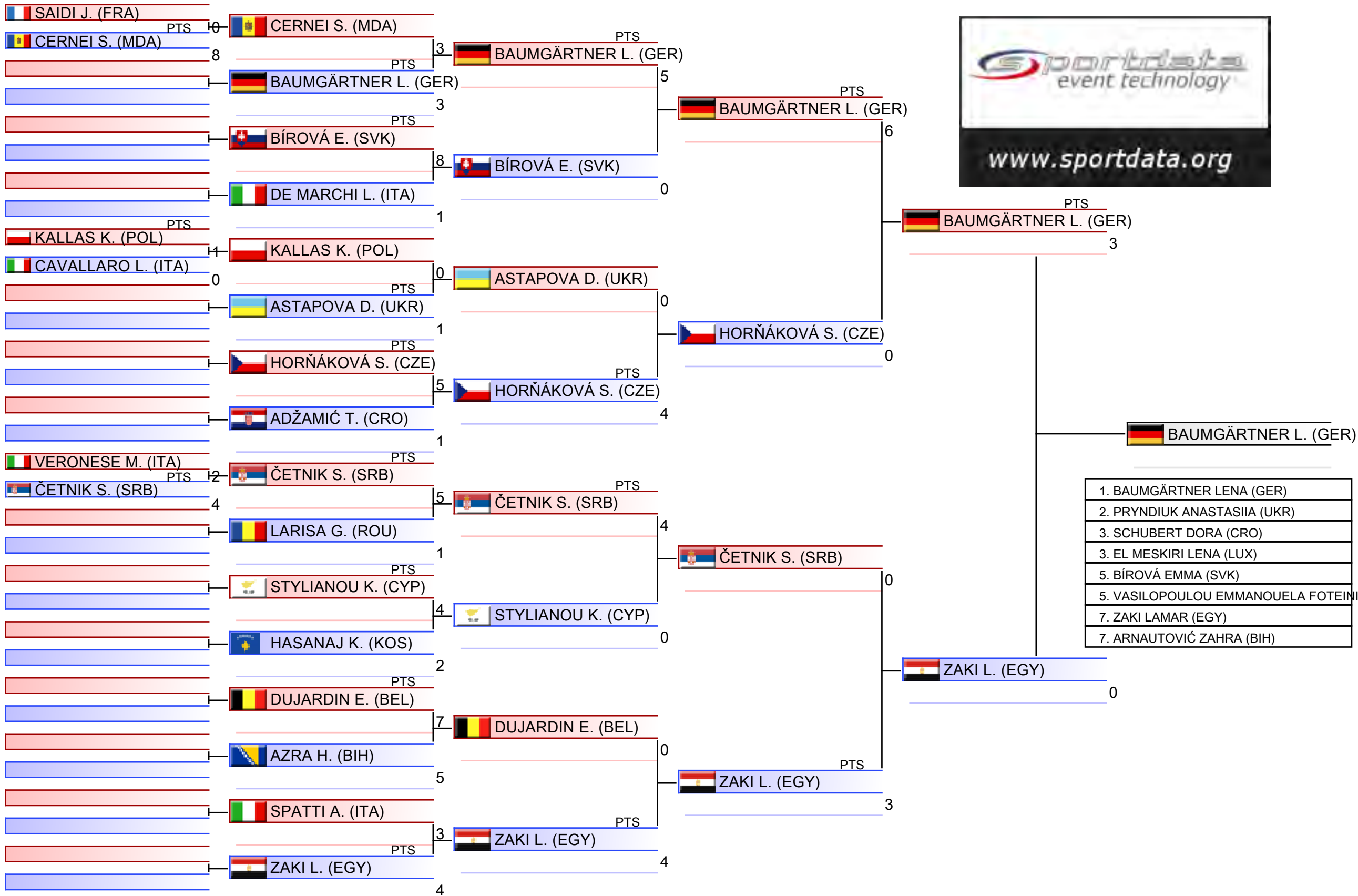

- | | |
|----|---------------------------------------|
| 1. | BAUMGÄRTNER LENA (GER) |
| 2. | PRYNDIUK ANASTASIIA (UKR) |
| 3. | SCHUBERT DORA (CRO) |
| 3. | EL MESKIRI LENA (LUX) |
| 5. | BÍROVÁ EMMA (SVK) |
| 5. | VASILOPOULOU EMMANOUELA FOTEINI (GRE) |
| 7. | ZAKI LAMAR (EGY) |
| 7. | ARNAUTOVIĆ ZAHRA (BIH) |

U14 Kumite Female -42 kg

Karate1 Youth League - Venice 2024, PALAZZO DEL TURISMO, Piazza Brescia 11, 30016 Lido di Jesolo VE, ITA

2024-12-07

Tatami
3 18:30

Pool
3/4

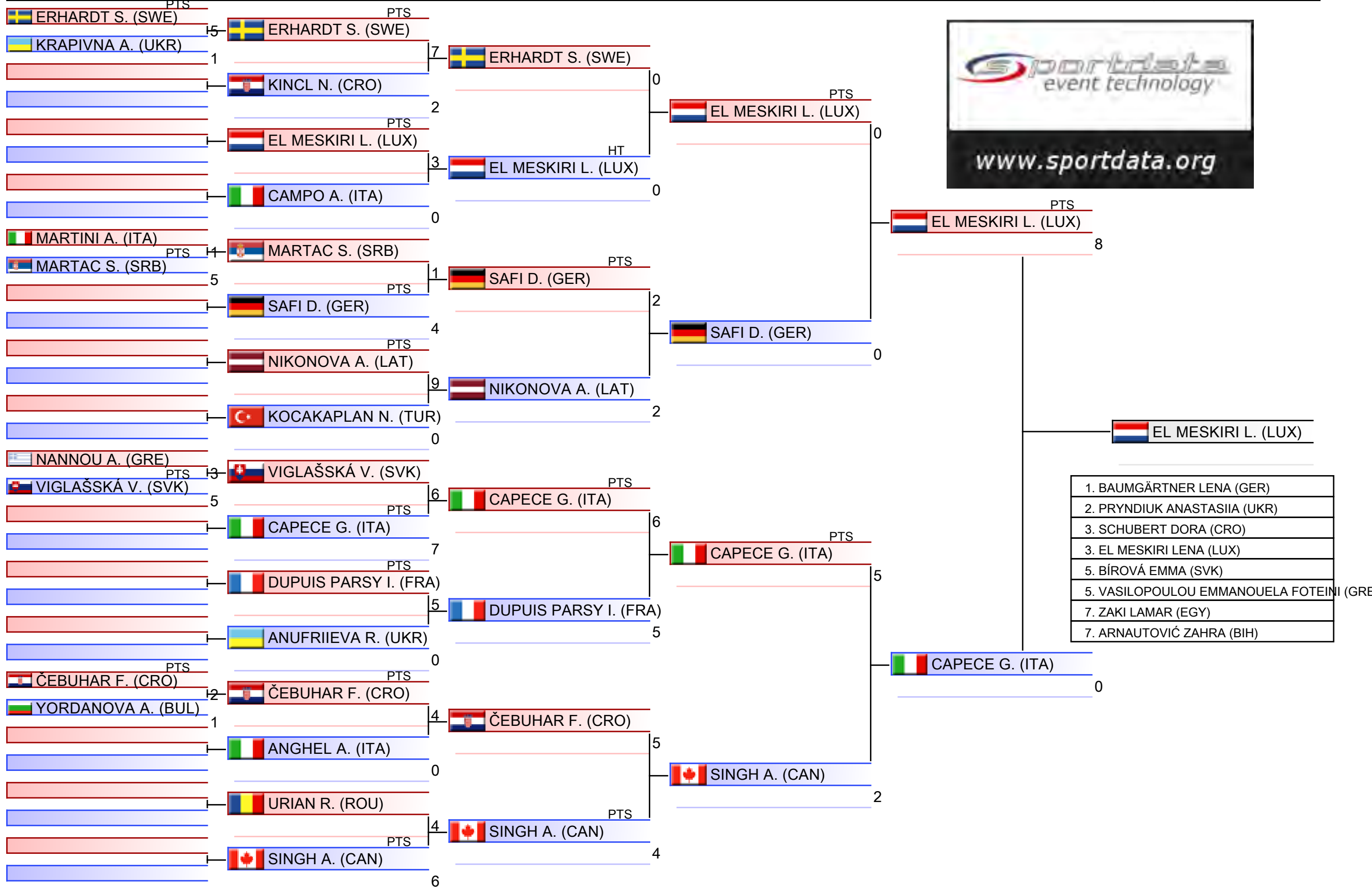

U14 Kumite Female -42 kg

Karate1 Youth League - Venice 2024, PALAZZO DEL TURISMO, Piazza Brescia 11, 30016 Lido di Jesolo VE, ITA

2024-12-07

Tatami
4 18:30

Pool
4/4

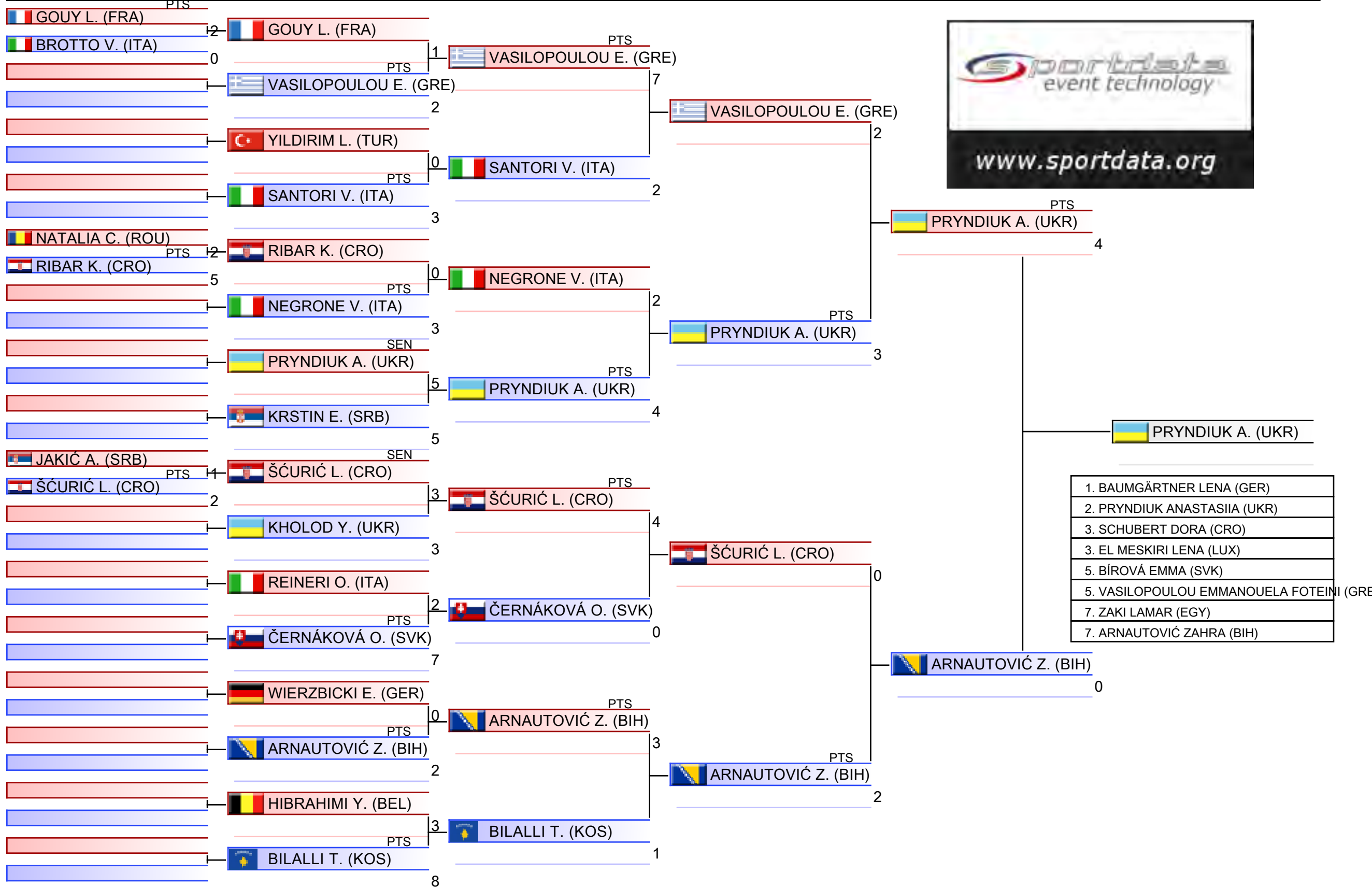

Pool winner-U14 Kumite Female -42 kg

Karate1 Youth League - Venice 2024, PALAZZO DEL TURISMO, Piazza Brescia 11, 30016 Lido di Jesolo VE, ITA

2024-12-07

Tatami

1 19:50

Pool

1/1

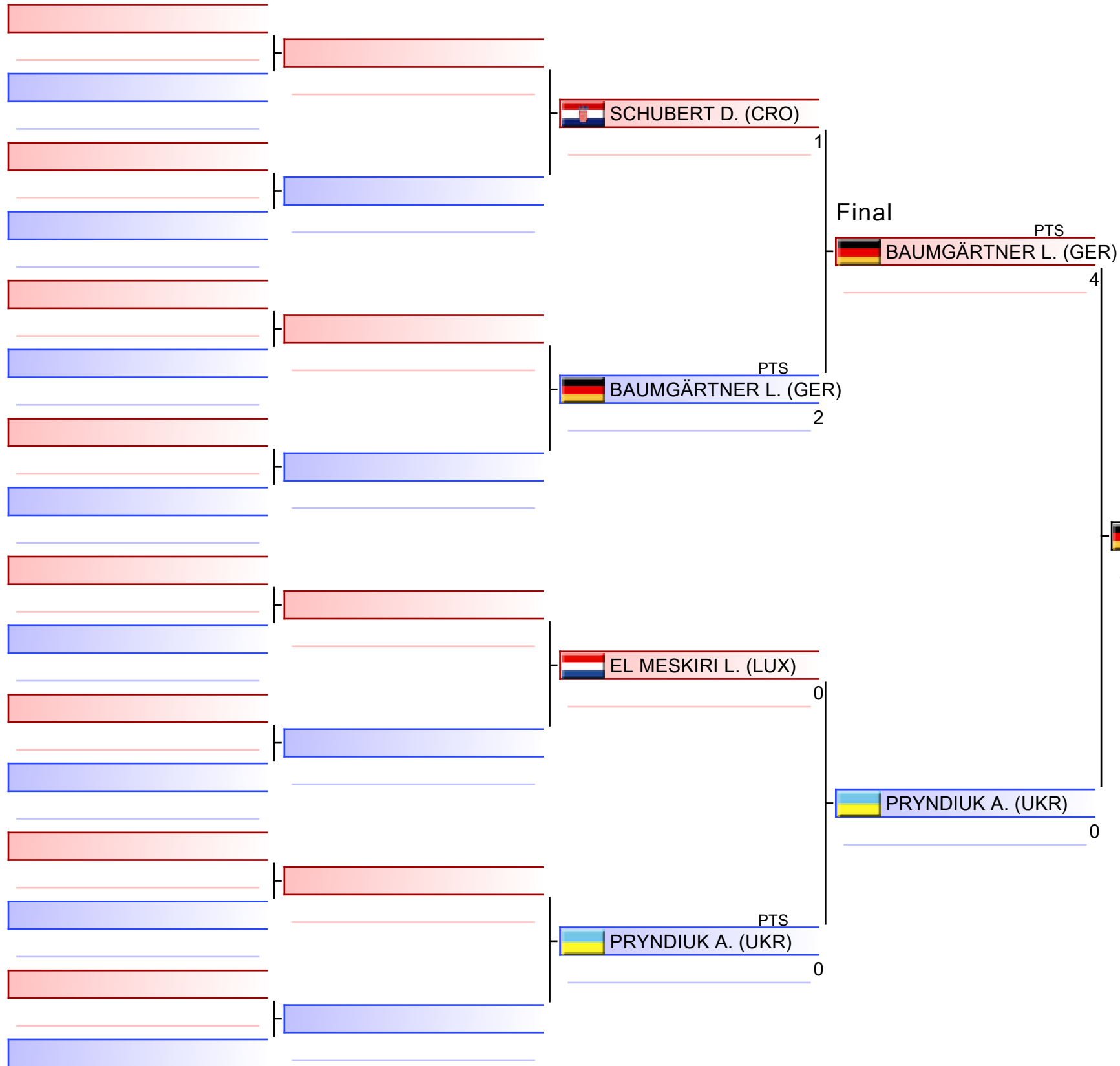

BAUMGÄRTNER L. (GER)

1. BAUMGÄRTNER LENA (GER)
2. PRYNDIUK ANASTASIIA (UKR)
3. SCHUBERT DORA (CRO)
3. EL MESKIRI LENA (LUX)
5. BÍROVÁ EMMA (SVK)
5. VASILOPOULOU EMMANOUELA FOTEINI (GRE)
7. ZAKI LAMAR (EGY)
7. ARNAUTOVIĆ ZAHRA (BIH)

U14 Kumite Female -42 kg

Karate1 Youth League - Venice 2024

2024-12-07

Tatami
1 19:55

Pool
1,2

(c)sportdata GmbH & Co KG 2000-2024 (2024-12-08 20:16) v 10.2.0 build 1 (2024-11-20 00:58 CET) License: SDIL TVG (expire 2025-01-26)

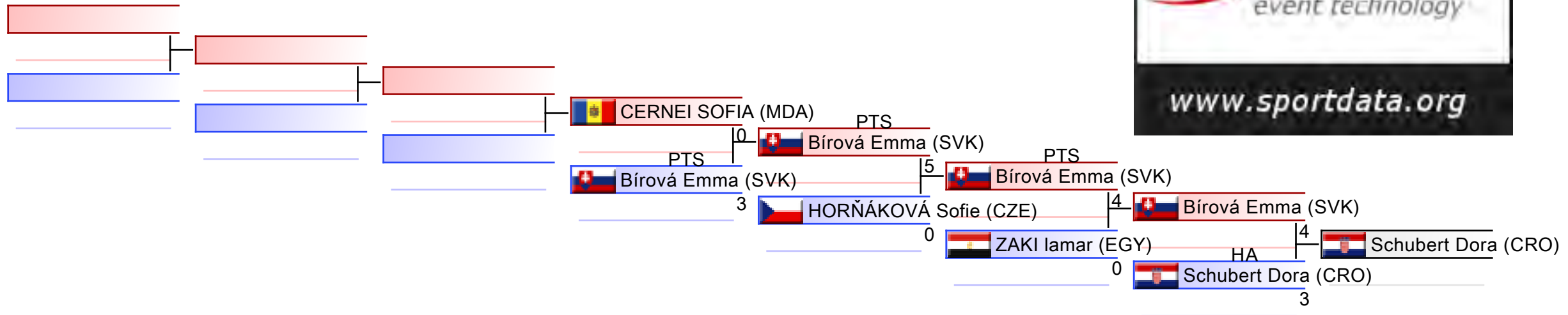

REPECHAGE: (1,2)

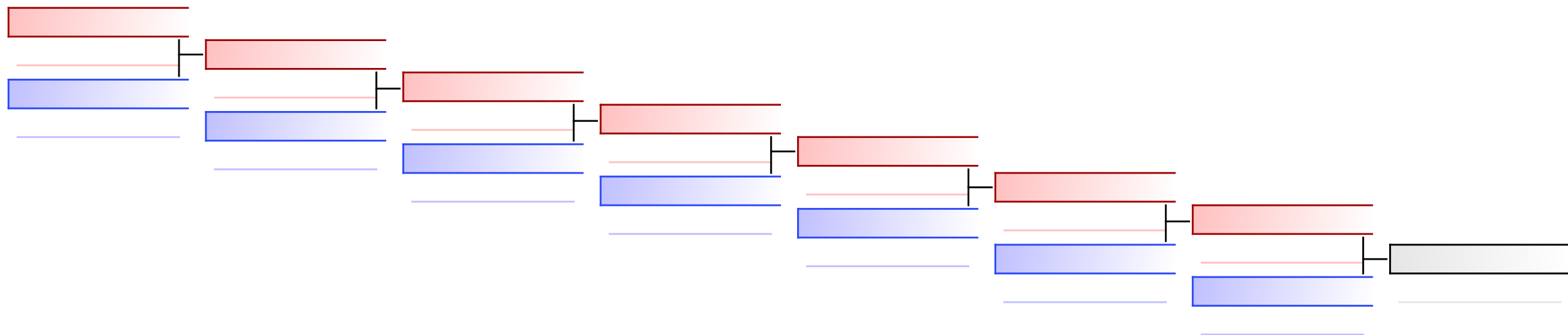

U14 Kumite Female -42 kg

Karate1 Youth League - Venice 2024

2024-12-07

Tatami

3 19:55

Pool

4,3

(c)sportdata GmbH & Co KG 2000-2024 (2024-12-08 20:16) v 10.2.0 build 1 (2024-11-20 00:58 CET) License: SDIL TVG (expire 2025-01-26)

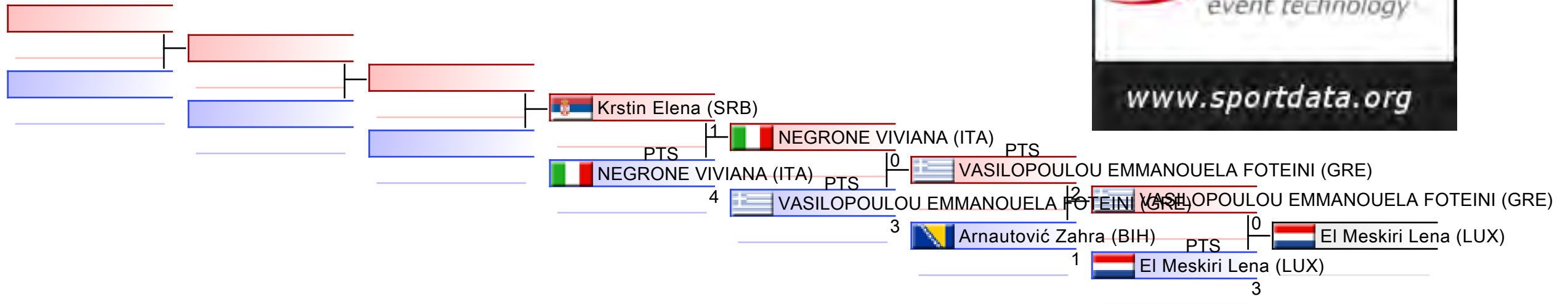

REPECHAGE: (4,3)

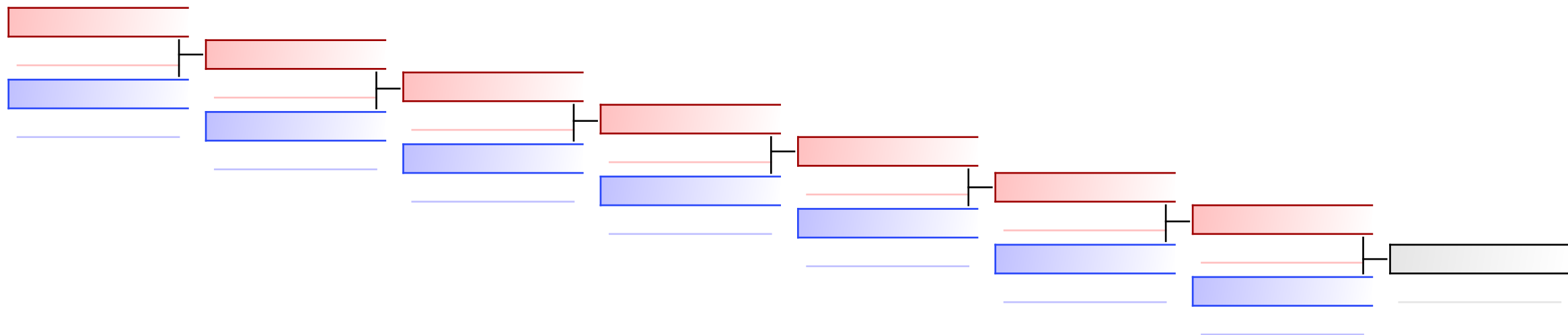



Karate1 Youth League - Venice 2024 - 2024-12-04



Official Results

U14 Kumite Female -42 kg (Entries: 78 Nations: 29)			
1	BAUMGÄRTNER LENA		GER - GERMANY
2	PRYNDIUK ANASTASIIA		UKR - UKRAINE
3	SCHUBERT DORA		CRO - CROATIA
3	EL MESKIRI LENA		LUX - LUXEMBOURG
5	BÍROVÁ EMMA		SVK - SLOVAKIA
5	VASILOPOULOU EMMANOUELA FOTEINI		GRE - GREECE
7	ZAKI LAMAR		EGY - EGYPT
7	ARNAUTOVIĆ ZAHRA		BIH - BOSNIA AND HERZEGOVINA
9	HORNÁKOVÁ SOFIE		CZE - CZECH REPUBLIC
9	NEGRONE VIVIANA		ITA - ITALY
11	CERNEI SOFIA		MDA - MOLDOVA, REPUBLIC OF
11	KRSTIN ELENA		SRB - SERBIA

U14 KUMITE FEMALE -47 KG



Karate1 Youth League - Venice 2024

ENTRIES BY WEIGHT CATEGORY



U14 Kumite Female -47 kg

As of 8 DEC 2024

Country Code	ID	Gender	Name	Seeding
AUT	AUT03047	F	Bayram Mira	
BEL		F	Hacquain Maëlie	
BIH		F	Brkanic Amna	
BIH		F	Ibrahimović Amna	
BIH		F	Mušinović Ena	
BUL		F	Bratuhceva Danaya	
BUL		F	Dineva Raya	
BUL		F	Yordanova Raya	
CRO		F	Bajrić Ajla	
CRO		F	Jelcic Roza	
CRO		F	Jerkin Franka	
CRO		F	Maduna Ivana	
CRO		F	Skitarelić Gabi	
CZE		F	Ševcová Barbora	
ENG		F	Bilaloglu Firdaous	
ENG		F	owusu-agyemang kylah	
ESP		F	BAEZ RODRIGUEZ DANIELA	
ESP		F	GARCIA RUIZ AINHOA	
FRA		F	ARNE Nawel	
FRA		F	Bouschbacher Lilou	
FRA		F	FATMI INES	
FRA		F	Gutschmidt Zoe	
FRA		F	PODINA DANIELA	
FRA		F	ROUSSEAU Ysée	
GER		F	Baumgärtner Lara	
GER		F	Dietrich Enie	
GER		F	Grüner Valentina	
GER		F	Olschewski Hanna	
GER		F	Röder Luise	
GER		F	Schlegel Ronja	
GER		F	Sirichenko Anfissa	
GER		F	Tsvilii Zlata	
GRE		F	ANDREOU MARIA	
GRE	GRE03008	F	CHYTI VALERIANI	
GRE	GRE003748	F	EVGENIADOU APOSTOLIA	
GRE		F	KONSTA EVANTHIA EVANGELIA	
ITA		F	Cescut Emma	
ITA		F	Chakir Fatima Azahra	
ITA		F	Dettori Sabrina	
ITA		F	Di Fiore Alessia	
ITA		F	Di Latte Gaia	
ITA		F	Lochi Samuela	
ITA		F	Rovere Lisa	
ITA		F	Spampinato Giada	
ITA		F	succi denise	



Karate1 Youth League - Venice 2024

ENTRIES BY WEIGHT CATEGORY



U14 Kumite Female -47 kg

As of 8 DEC 2024

Country Code	ID	Gender	Name	Seeding
ITA		F	Tescari Kristel	
ITA		F	Todesca Carmen	
ITA		F	VALNEGRI ANNA	
KOS	KOS03292	F	SHERIFI ERINA	
LUX		F	Belabass Zineb	
MDA	MDA002527	F	ROIBA MADALINA	
NED	SD81136	F	Pcholko Varvara	
POL	POL05545	F	BALUT PATRYCJA	
POR		F	Coelho Leonor	
POR		F	Gonçalves Diana Filipa	
POR		F	LADEIRO MATILDE	
POR		F	Lourenço Alice	
ROU	ROU03629	F	BOLINTIRU DARIA	
ROU	ROU03614	F	CHIRIAC ANDREEA	
ROU	ROU003859	F	ESTERA APOSTOLACHE	
SLO	SLO02695	F	IVANCIC KIARA	
SLO		F	Rocco Ilaria	
SLO	SLO003071	F	TOMAZEVIC JULIJA	
SLO		F	TRAMŠEK ALJA	
SRB		F	Rudinac Anastasija	
SRB		F	Subotić Milica	
SUI		F	WIDMER Alisha	
TUR		F	GÜRBÜZ BEYZA YAĞMUR	
TUR		F	GURBUZ TURNA	
UKR		F	Bychenkova Polina	
UKR		F	Chuprina Arina	
UKR		F	Denysenko Aryna	
UKR		F	Filatova Veronika	
UKR		F	Hnativ Anastasiia	
UKR		F	Kossak Roksolana	
UKR		F	Mezentseva Kateryna	
UKR		F	Muravska Yelyzaveta	
UKR		F	Revunova Mariia	
UKR		F	Salnyk Anita	
UKR		F	Shapovalova Mariia	
UKR		F	SOTNIKOVA IVANNA	
USA		F	Allen Presley	

U14 Kumite Female -47 kg

Karate1 Youth League - Venice 2024, PALAZZO DEL TURISMO, Piazza Brescia 11, 30016 Lido di Jesolo VE, ITA

2024-12-07

Tatami
5 17:25

Pool
1/4

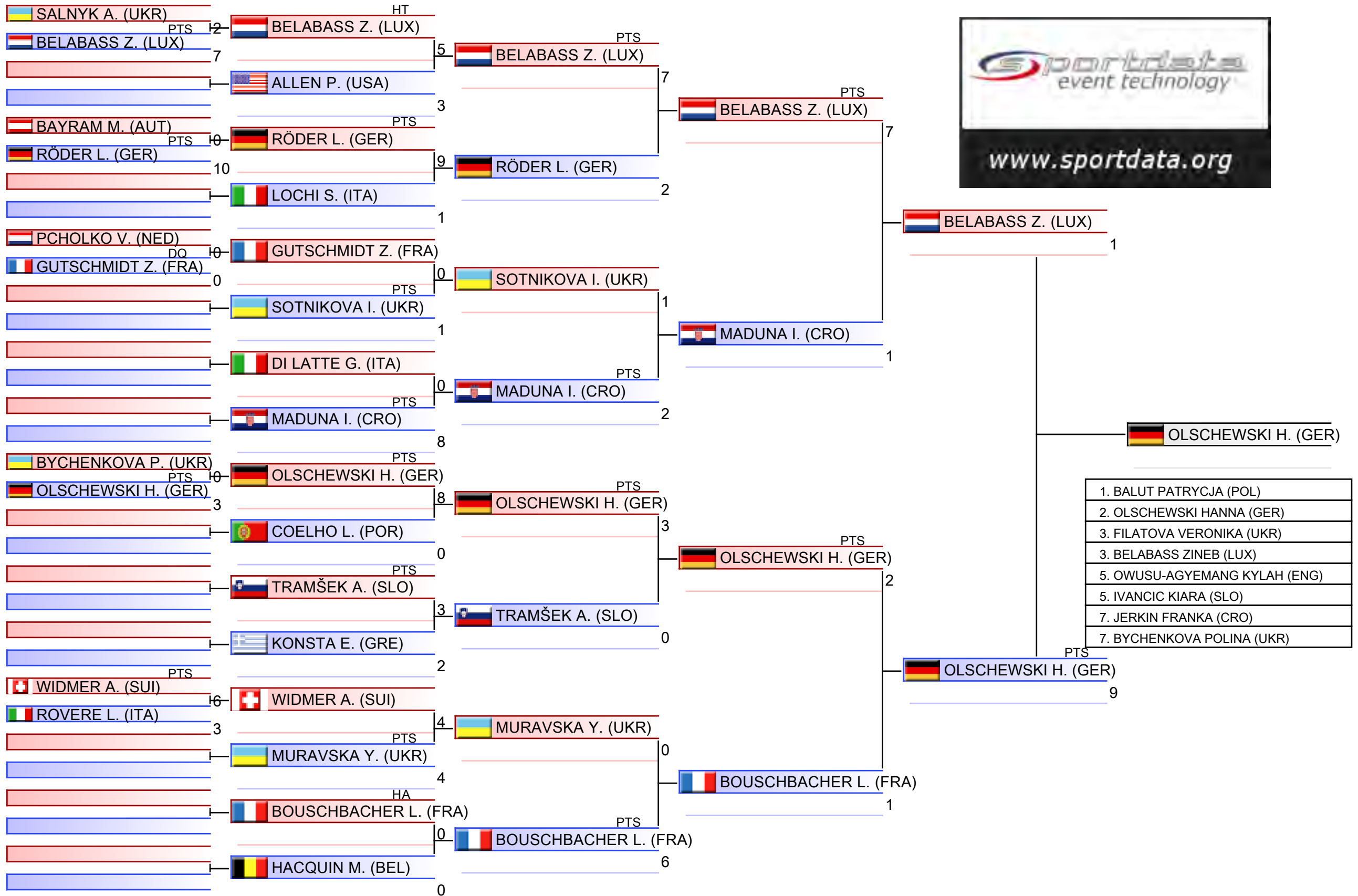

U14 Kumite Female -47 kg

Karate1 Youth League - Venice 2024, PALAZZO DEL TURISMO, Piazza Brescia 11, 30016 Lido di Jesolo VE, ITA

2024-12-07

Tatami
6 17:25

Pool
2/4

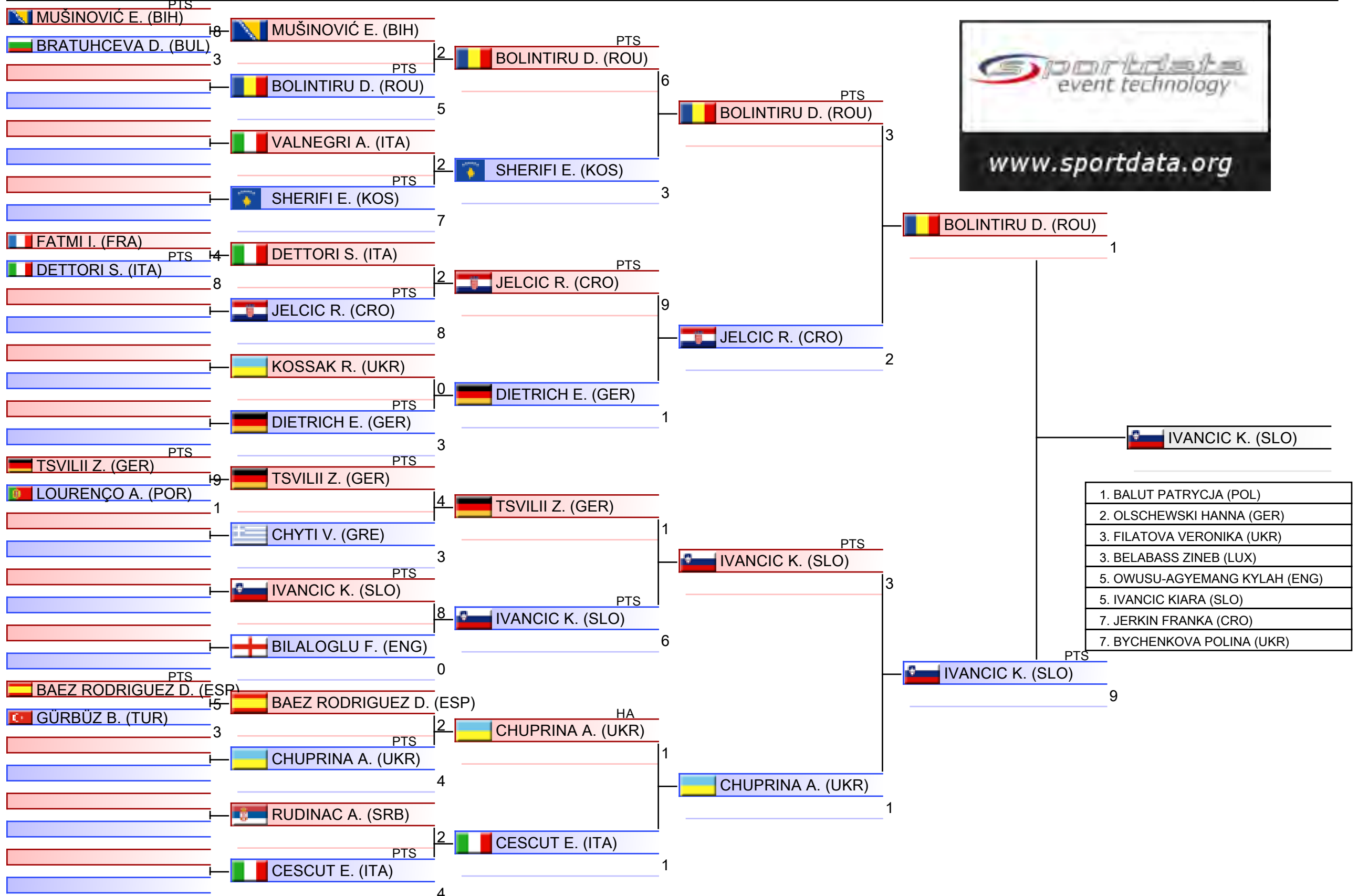

U14 Kumite Female -47 kg

Karate1 Youth League - Venice 2024, PALAZZO DEL TURISMO, Piazza Brescia 11, 30016 Lido di Jesolo VE, ITA

2024-12-07

Tatami
7 17:25

Pool
3/4

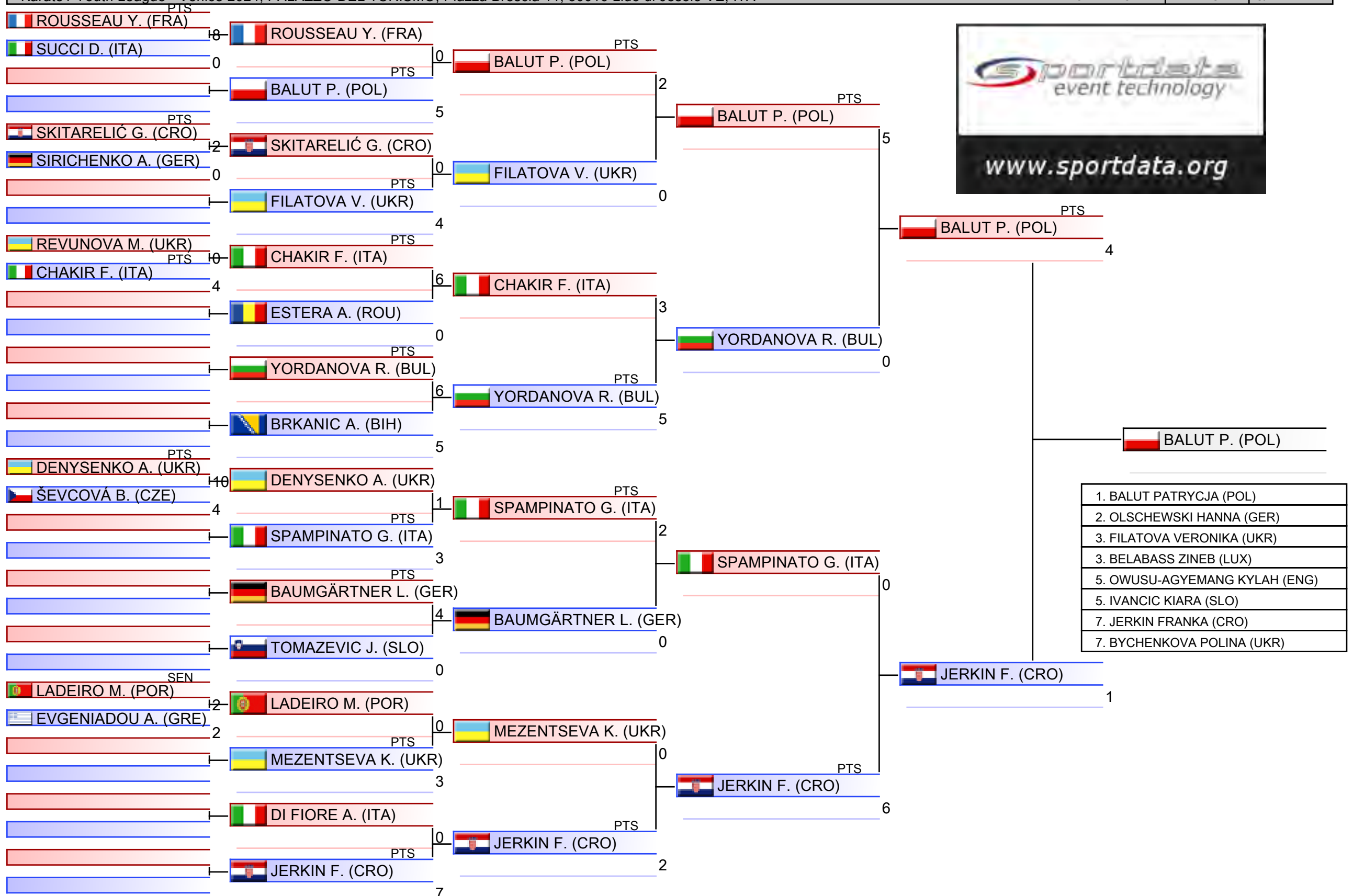

- | |
|-------------------------------|
| 1. BALUT PATRYCJA (POL) |
| 2. OLSCHEWSKI HANNA (GER) |
| 3. FILATOVA VERONIKA (UKR) |
| 3. BELABASS ZINEB (LUX) |
| 5. OWUSU-AGYEMANG KYLAH (ENG) |
| 5. IVANCIC KIARA (SLO) |
| 7. JERKIN FRANKA (CRO) |
| 7. BYCHENKOVA POLINA (UKR) |

U14 Kumite Female -47 kg

Karate1 Youth League - Venice 2024, PALAZZO DEL TURISMO, Piazza Brescia 11, 30016 Lido di Jesolo VE, ITA

2024-12-07

Tatami
8 17:25

Pool
4/4

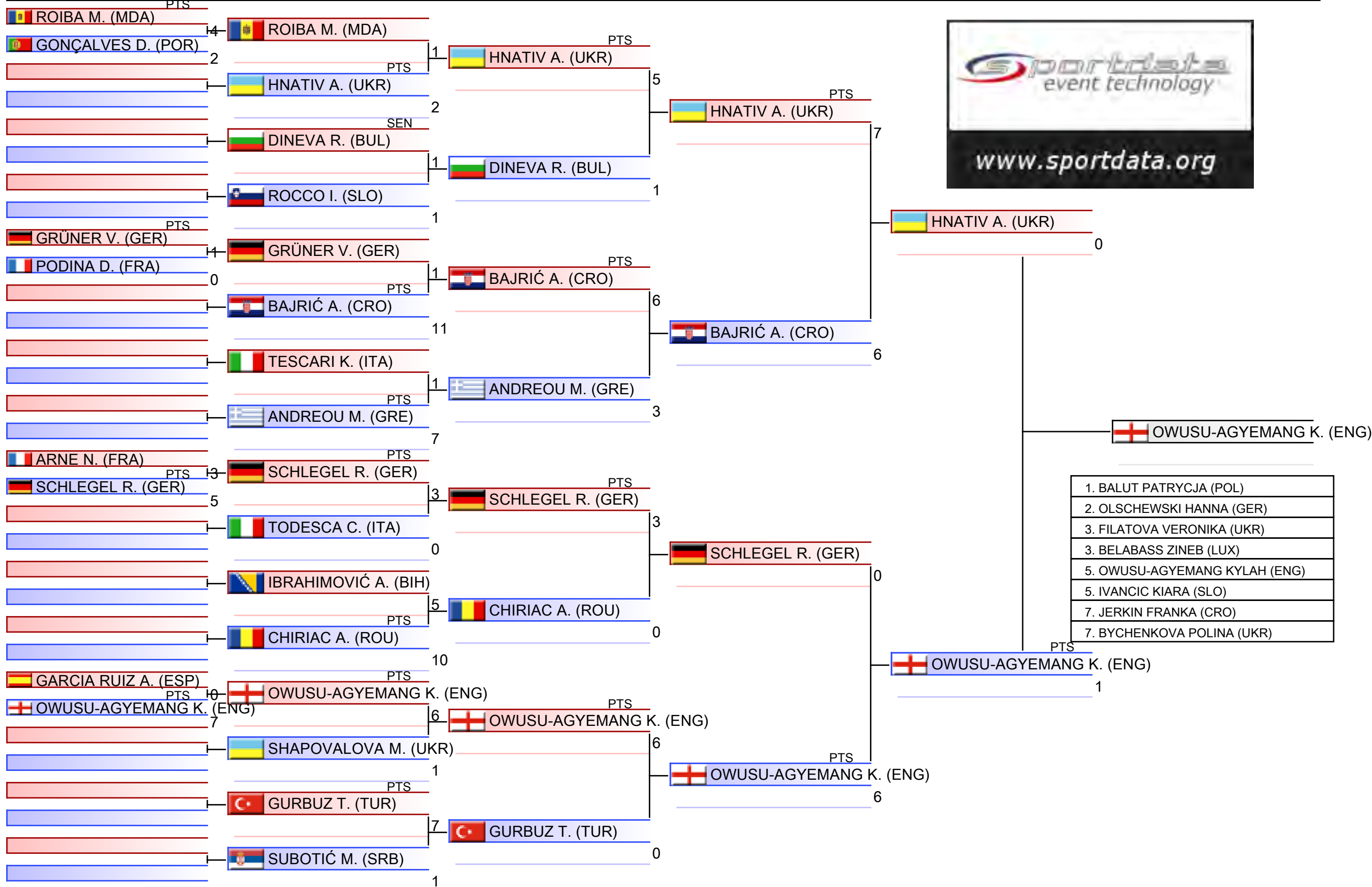

1. BALUT PATRYCJA (POL)
2. OLSCHEWSKI HANNA (GER)
3. FILATOVA VERONIKA (UKR)
3. BELABASS ZINEB (LUX)
5. OWUSU-AGYEMANG KYLAH (ENG)
5. IVANCIC KIARA (SLO)
7. JERKIN FRANKA (CRO)
7. BYCHENKOVA POLINA (UKR)

Pool winner-U14 Kumite Female -47 kg

Karate1 Youth League - Venice 2024, PALAZZO DEL TURISMO, Piazza Brescia 11, 30016 Lido di Jesolo VE, ITA

2024-12-07

Tatami
5 19:00

Pool
1/1

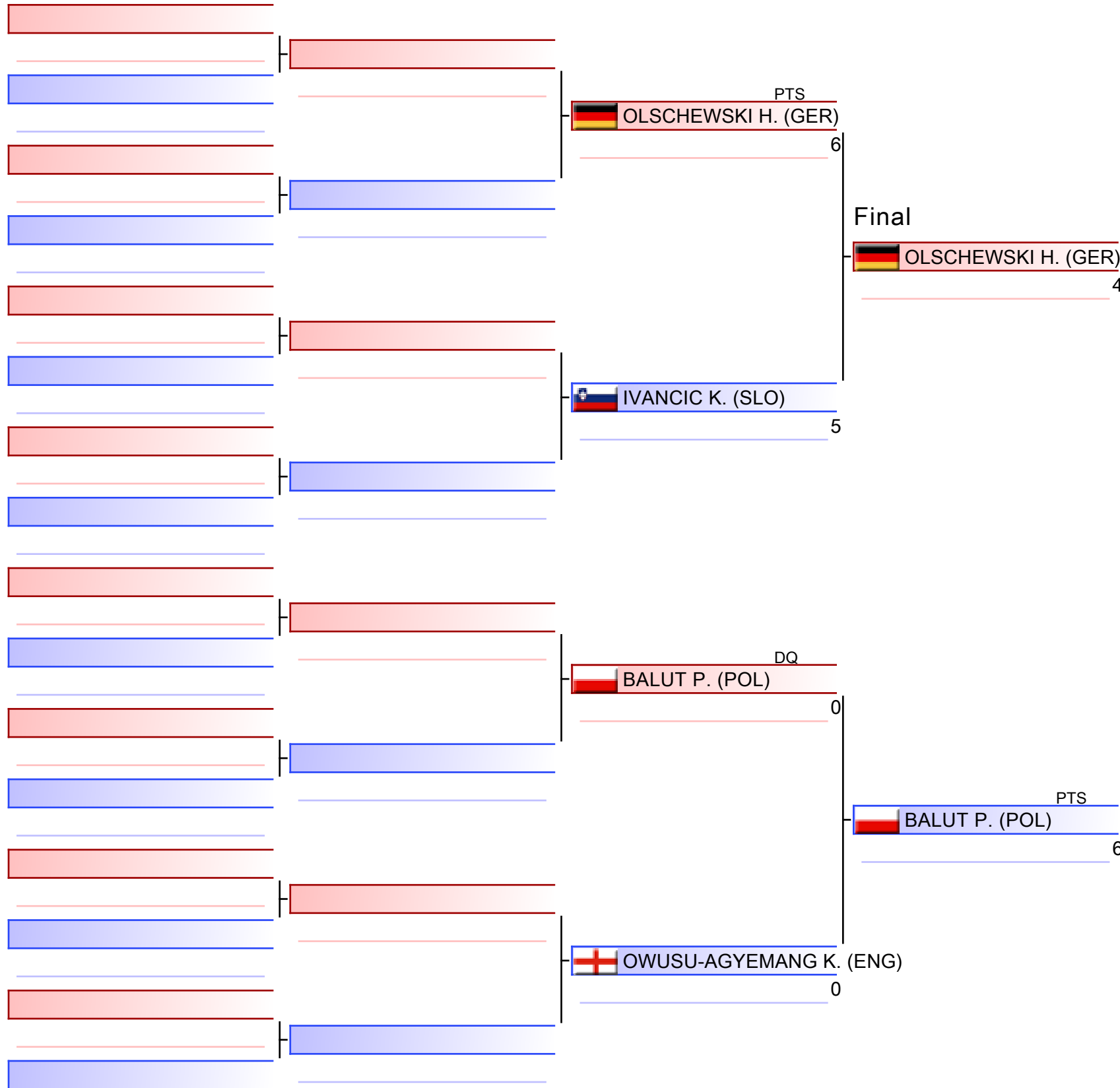

BALUT P. (POL)

1. BALUT PATRYCJA (POL)
2. OLSCHEWSKI HANNA (GER)
3. FILATOVA VERONIKA (UKR)
3. BELABASS ZINEB (LUX)
5. OWUSU-AGYEMANG KYLAH (ENG)
5. IVANCIC KIARA (SLO)
7. JERKIN FRANKA (CRO)
7. BYCHENKOVA POLINA (UKR)

U14 Kumite Female -47 kg

Karate1 Youth League - Venice 2024

2024-12-07

Tatami
2 19:50

Pool
1,2

(c)sportdata GmbH & Co KG 2000-2024 (2024-12-08 20:16) v 10.2.0 build 1 (2024-11-20 00:58 CET) License: SDIL TVG (expire 2025-01-26)

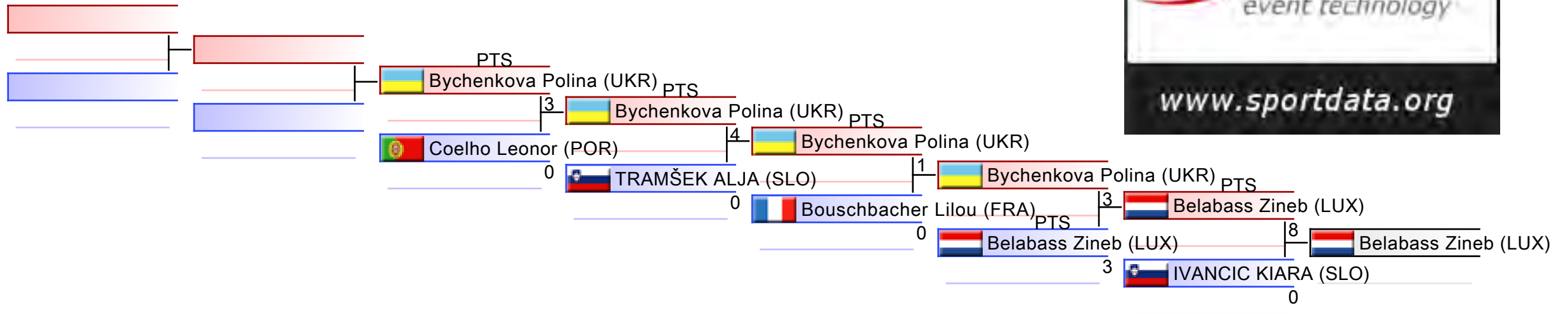

REPECHAGE: (1,2)

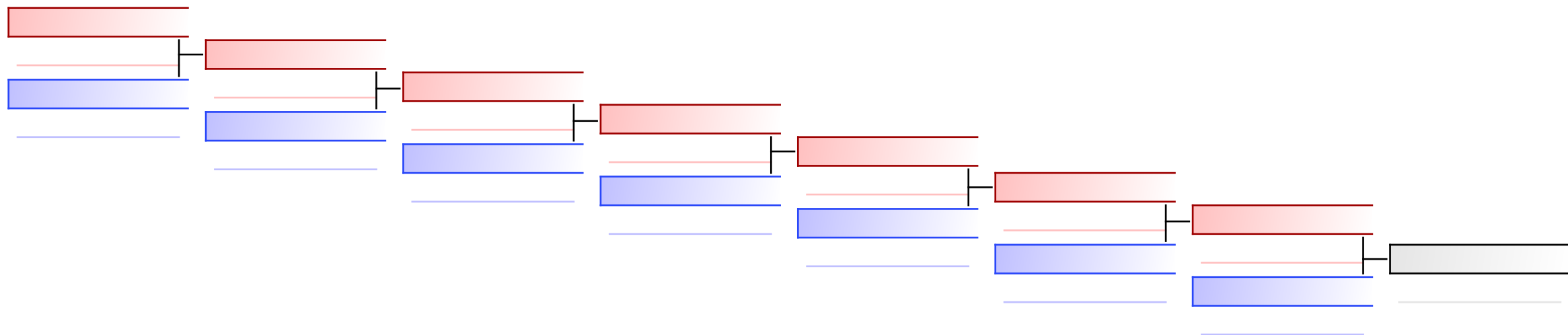

U14 Kumite Female -47 kg

Karate1 Youth League - Venice 2024

2024-12-07

Tatami
4 19:50

Pool
3,4

(c)sportdata GmbH & Co KG 2000-2024 (2024-12-08 20:16) v 10.2.0 build 1 (2024-11-20 00:58 CET) License: SDIL TVG (expire 2025-01-26)

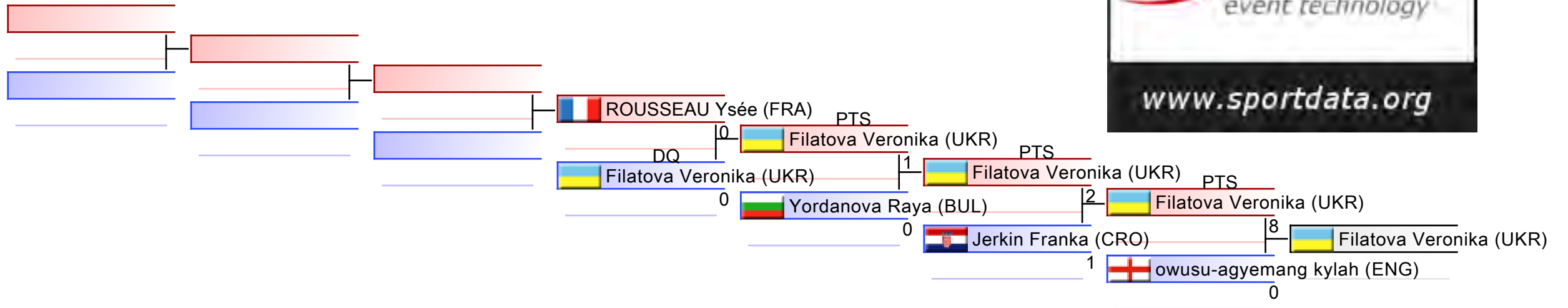

REPECHAGE: (3,4)

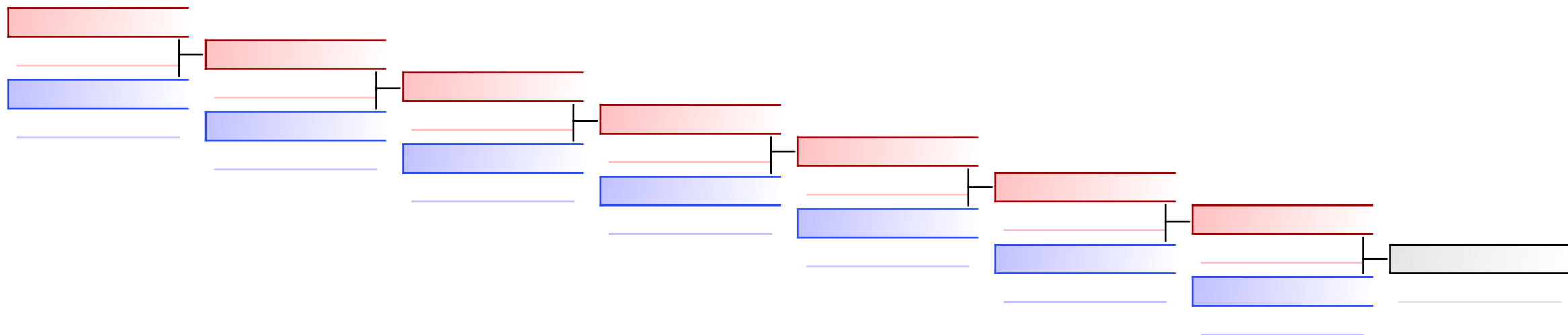



Karate1 Youth League - Venice 2024 - 2024-12-04



Official Results

U14 Kumite Female -47 kg (Entries: 82 Nations: 25)			
1	BALUT PATRYCJA		POL - POLAND
2	OLSCHEWSKI HANNA		GER - GERMANY
3	FILATOVA VERONIKA		UKR - UKRAINE
3	BELABASS ZINEB		LUX - LUXEMBOURG
5	OWUSU-AGYEMANG KYLAH		ENG - ENGLAND
5	IVANCIC KIARA		SLO - SLOVENIA
7	JERKIN FRANKA		CRO - CROATIA
7	BYCHENKOVA POLINA		UKR - UKRAINE
9	YORDANOVA RAYA		BUL - BULGARIA
9	BOUSCHBACHER LILOU		FRA - FRANCE
11	ROUSSEAU YSÉE		FRA - FRANCE
11	TRAMŠEK ALJA		SLO - SLOVENIA
13	COELHO LEONOR		POR - PORTUGAL

U14 KUMITE FEMALE -52 KG



Karate1 Youth League - Venice 2024

ENTRIES BY WEIGHT CATEGORY



U14 Kumite Female -52 kg

As of 8 DEC 2024

Country Code	ID	Gender	Name	Seeding
ARM	ARM003064	F	HARUTYUNYAN NANE	
AUT	AUT02961	F	Sopic Noemi	
BIH		F	Kurtović Edina	
BIH		F	Mičević Teona	
BIH		F	Skenderija-Rašljic Milica	
BUL		F	Kondova Elena	
BUL		F	Petkova Viktoria	
BUL		F	Todorova Albena	
CAN		F	INGALDO ROSALIA	
CHI		F	Cerpa Emilia	
CRO		F	Slišković Iva	
CZE	CZE02844	F	CIRHANOVA NICOL	
CZE		F	Petříková Nathálie	
CZE		F	Vachtová Eva	
CZE		F	Válková Laura	
ENG		F	Atkiss Gracie	
ENG		F	Gallant Rhaea	
ENG		F	Jenkins Harriet	
ENG		F	Urban Maja	
ESP		F	Folgueira González Uxia	
ESP		F	MELGAR POSTIGO JULIA MARIA	
ESP		F	Quinto Gomez Luna	
FIN		F	Stefanski Vanessa	
FRA		F	Lacourt Emie	
FRA		F	Martinez Lola	
FRA		F	Prabel-Cecchini Justine	
FRA		F	Queste Rosie	
GER		F	Förster Alexia	
GER		F	Hübinger Melina	
GER		F	Khalil Lana	
GER		F	Liedke Loreen	
GER		F	Meyen Selda	
GER		F	Podlaszewska Kirana	
GER		F	Pönitz Hayley	
GER		F	Rumpf Cilia	
GER		F	Voigt Johanna	
GRE	GRE03453	F	MOUSOULI ANNA	
ITA		F	Arena Mariachiarra	
ITA		F	Azzena Bianca	
ITA		F	Carnimeo Patrizia	
ITA		F	DE PASQUALE SILVIA	
ITA	ITA-534808	F	DI CATALDO GAIA	
ITA		F	Donati Elena	
ITA		F	Herrero Libertad	
ITA		F	Palombi Sofia	



Karate1 Youth League - Venice 2024

ENTRIES BY WEIGHT CATEGORY



U14 Kumite Female -52 kg

As of 8 DEC 2024

Country Code	ID	Gender	Name	Seeding
ITA		F	PIRRI MARIA	
ITA		F	ROSSI MICHELA	
ITA		F	Scarsi Alice	
ITA		F	STELLA FEDERICA	
KOS	KOS003633	F	REXHEPI DANINA	
LAT		F	Mickevica Estere	
LUX		F	Durrer Nahima	
LUX		F	Rosa Maelys	
MDA	MDA002541	F	RUSNAC ANASTASIA	
MNE		F	Emira Gjonoviq	
NED	SD81137	F	Keulen van Norah	
NED		F	Van bommel Ise	
PER	SD76802	F	AGUIRRE CAVERO ARANZA LUCIA	
POR		F	Costa Teresa	
ROU	ROU003853	F	LORENA GABRIELA POROF	
ROU	ROU003850	F	PATRICIA ADRIANA MURESAN	
ROU	ROU03597	F	POPESCU BIANCA	
SLO	SLO02846	F	PURIC ADRIJANA	
SRB		F	Grujić Milica	
SRB		F	Jovanovic Nina	
SRB		F	Lazovic Minja	
SRB		F	Maksović Jovana	
SVK		F	KLEMPOVÁ Laura	
SVK		F	Póšová Lucia	
SVK		F	Schneider Petra	
SVK		F	Sevcikova Natalia	
TUR		F	ERASLAN ESMANUR HÜMEYRA	
UKR		F	Gryshchenko Daria	
UKR		F	Hryk-Vlasova Rehina	
UKR		F	KOLOBANOVA SVITLANA	
UKR		F	KRUHLOVA SHARLIZ	
UKR		F	Mashyra Sofiia	
UKR		F	Mollaieva Mariam	
UKR		F	Pirkovets Mariia	
UKR		F	SHEVCHENKO KARYNA	
USA		F	Arcalean Mihaela	

U14 Kumite Female -52 kg

Karate1 Youth League - Venice 2024, PALAZZO DEL TURISMO, Piazza Brescia 11, 30016 Lido di Jesolo VE, ITA

2024-12-08

Tatami
5 16:35

Pool
1/4

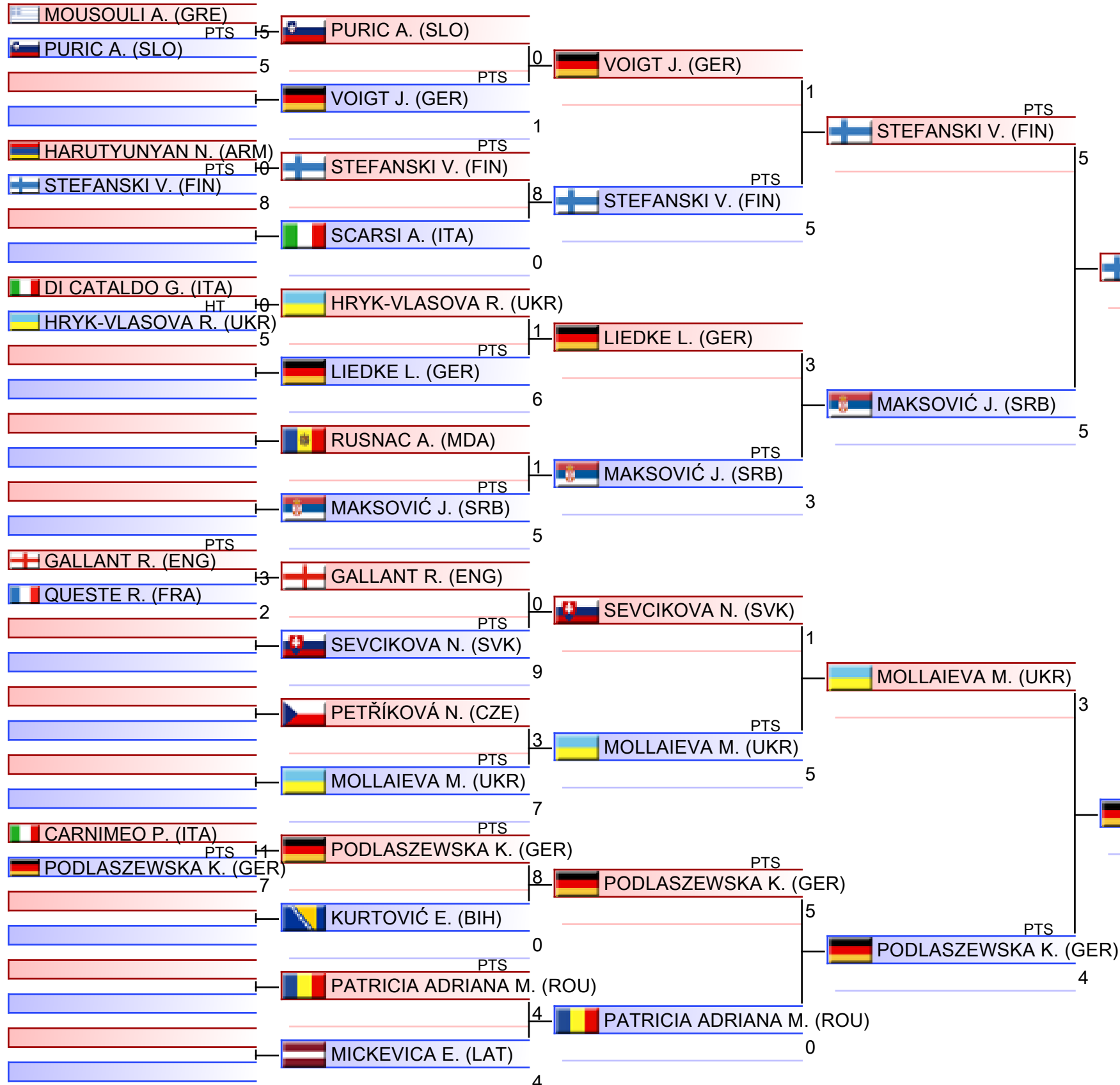

1.	ARCALEAN MIHAELA (USA)
2.	STEFANSKI VANESSA (FIN)
3.	HARUTYUNYAN NANE (ARM)
3.	MEYEN SELDA (GER)
5.	SHEVCHENKO KARYNA (UKR)
5.	KRUHLOVA SHARLIZ (UKR)
7.	PODLASZEWSKA KIRANA (GER)
7.	POPESCU BIANCA (ROU)

U14 Kumite Female -52 kg

Karate1 Youth League - Venice 2024, PALAZZO DEL TURISMO, Piazza Brescia 11, 30016 Lido di Jesolo VE, ITA

2024-12-08

Tatami
6 16:35

Pool
2/4

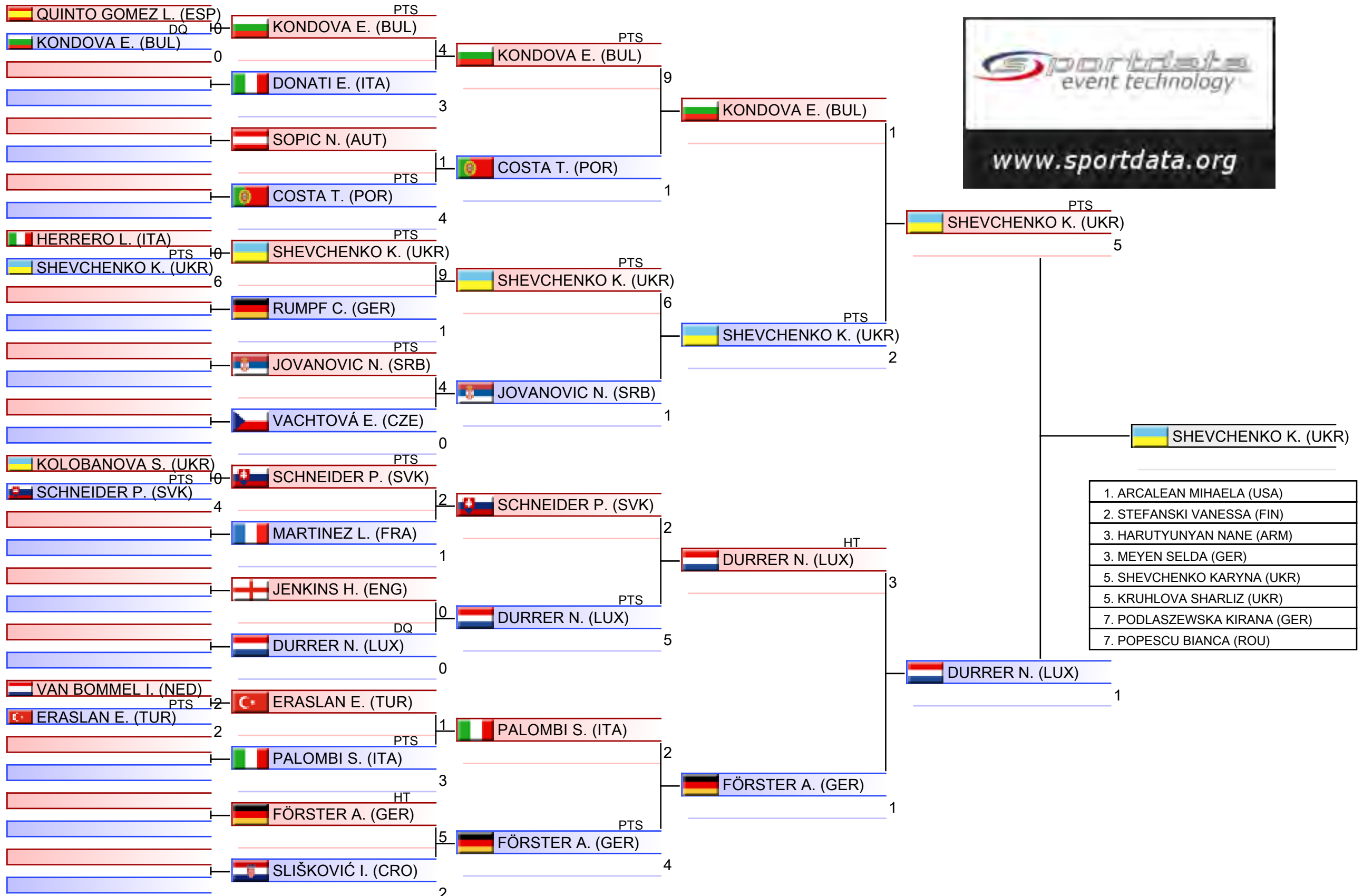

U14 Kumite Female -52 kg

Karate1 Youth League - Venice 2024, PALAZZO DEL TURISMO, Piazza Brescia 11, 30016 Lido di Jesolo VE, ITA

2024-12-08

Tatami
7 16:35

Pool
3/4

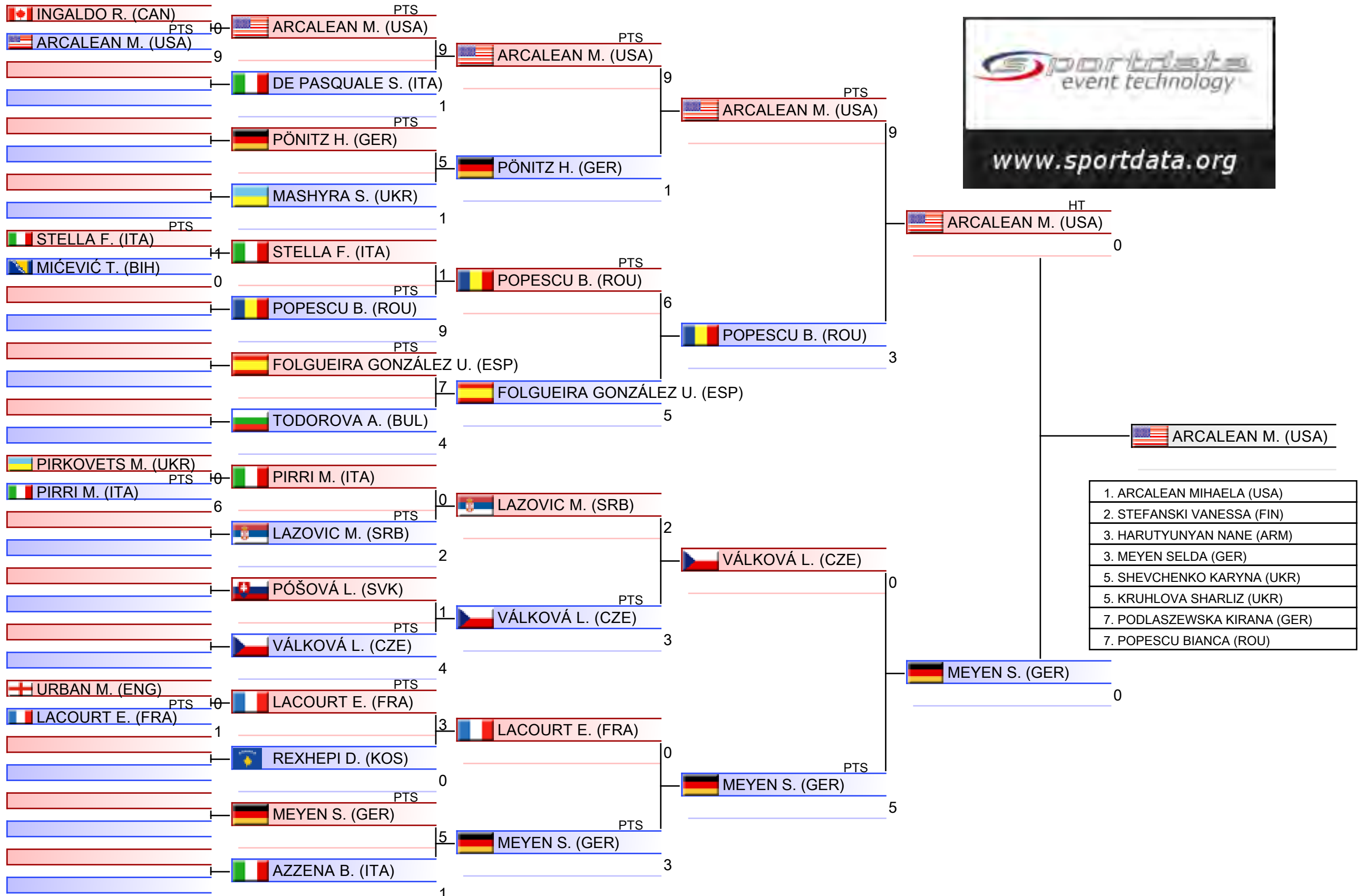

U14 Kumite Female -52 kg

Karate1 Youth League - Venice 2024, PALAZZO DEL TURISMO, Piazza Brescia 11, 30016 Lido di Jesolo VE, ITA

2024-12-08

Tatami
8 16:35

Pool
4/4

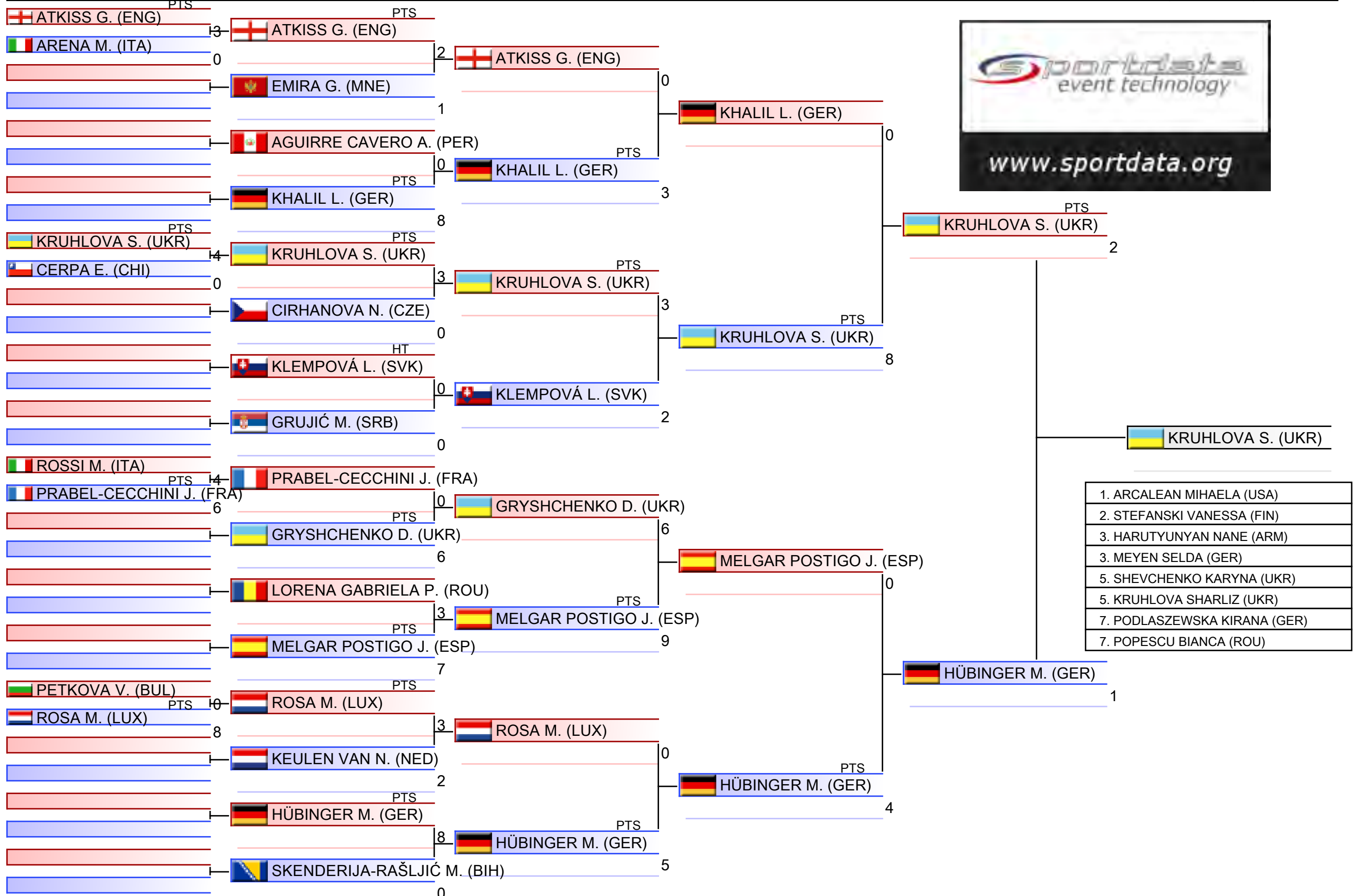

- | |
|------------------------------|
| 1. ARCALEAN MIHAELA (USA) |
| 2. STEFANSKI VANESSA (FIN) |
| 3. HARUTYUNYAN NANE (ARM) |
| 3. MEYEN SELDA (GER) |
| 5. SHEVCHENKO KARYNA (UKR) |
| 5. KRUHLOVA SHARLIZ (UKR) |
| 7. PODLASZEWSKA KIRANA (GER) |
| 7. POPESCU BIANCA (ROU) |

Pool winner-U14 Kumite Female -52 kg

Karate1 Youth League - Venice 2024, PALAZZO DEL TURISMO, Piazza Brescia 11, 30016 Lido di Jesolo VE, ITA

2024-12-08

Tatami
5 18:00

Pool
1/1

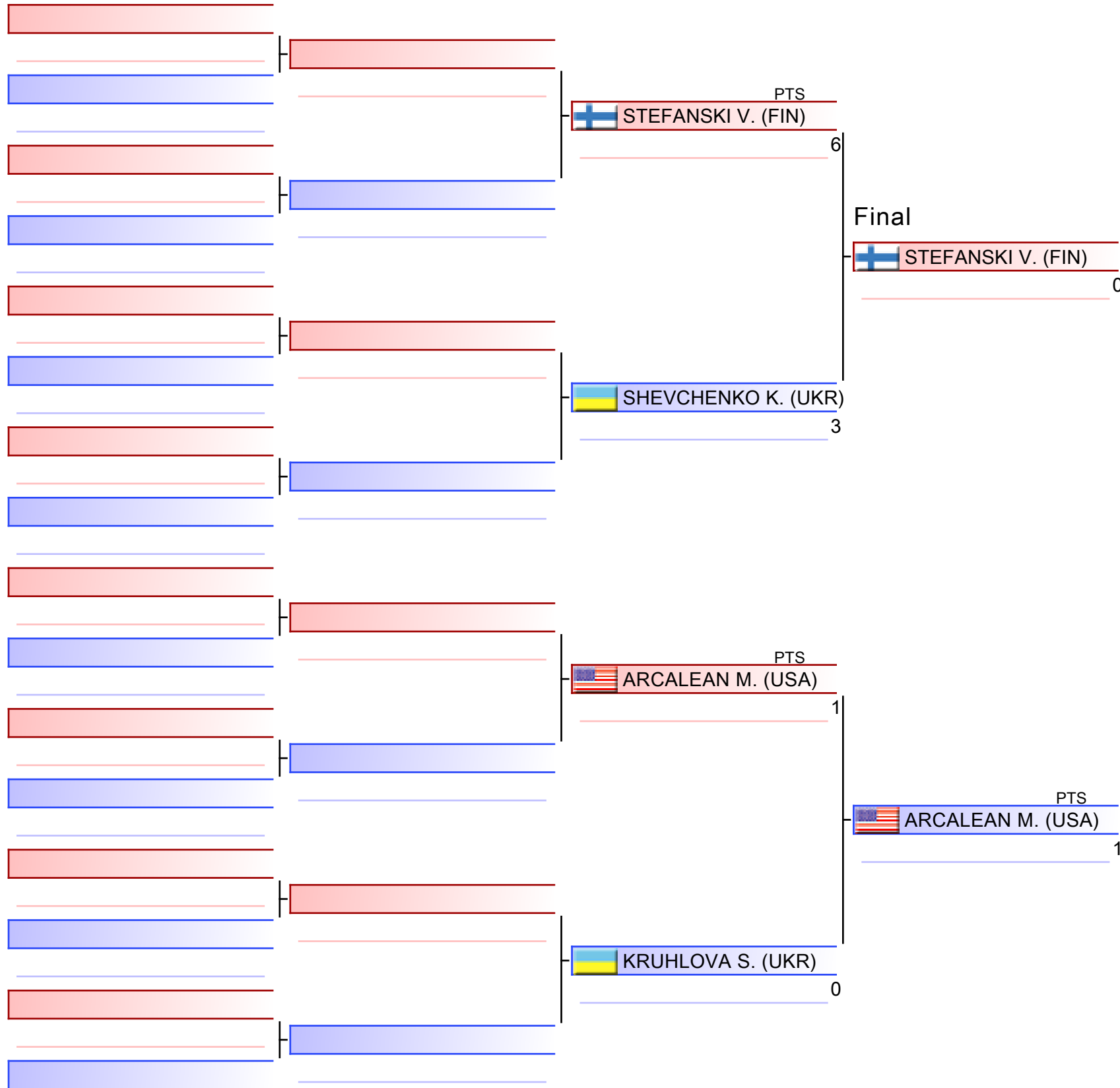

ARCALEAN M. (USA)

1. ARCALEAN MIHAELA (USA)
2. STEFANSKI VANESSA (FIN)
3. HARUTYUNYAN NANE (ARM)
3. MEYEN SELDA (GER)
5. SHEVCHENKO KARYNA (UKR)
5. KRUHLOVA SHARLIZ (UKR)
7. PODLASZEWSKA KIRANA (GER)
7. POPESCU BIANCA (ROU)

U14 Kumite Female -52 kg

Karate1 Youth League - Venice 2024

2024-12-08

Tatami
5 18:05

Pool
1,2

(c)sportdata GmbH & Co KG 2000-2024 (2024-12-08 20:16) v 10.2.0 build 1 (2024-11-20 00:58 CET) License: SDIL TVG (expire 2025-01-26)

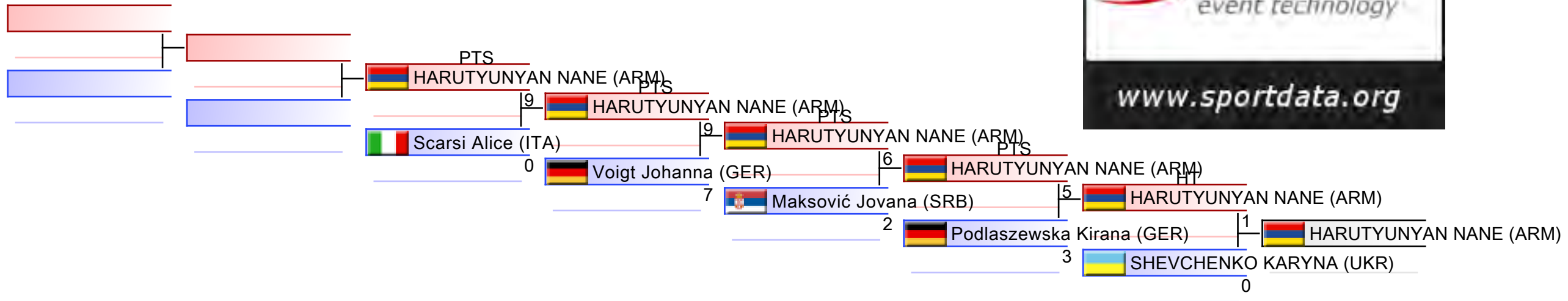

REPECHAGE: (1,2)

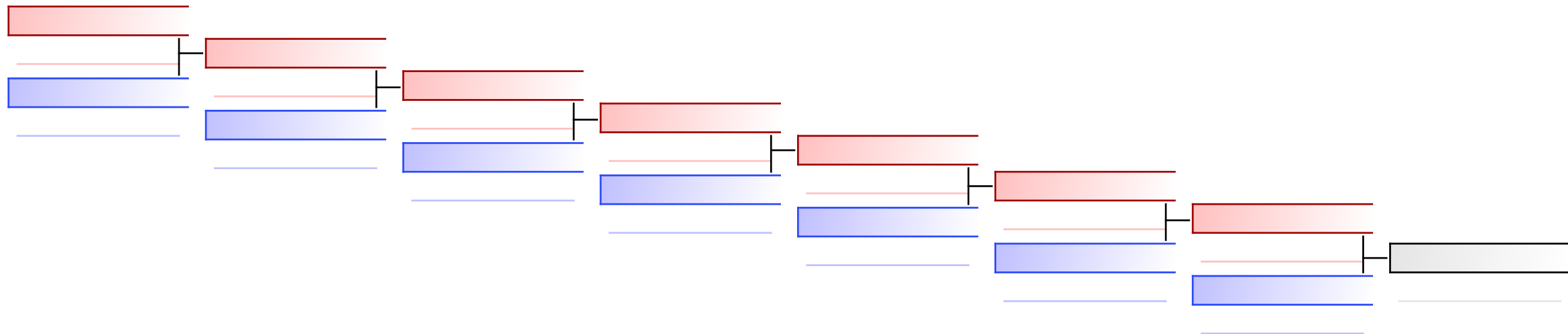

U14 Kumite Female -52 kg

Karate1 Youth League - Venice 2024

2024-12-08

Tatami
8 18:05

Pool
4,3

(c)sportdata GmbH & Co KG 2000-2024 (2024-12-08 20:16) v 10.2.0 build 1 (2024-11-20 00:58 CET) License: SDIL TVG (expire 2025-01-26)

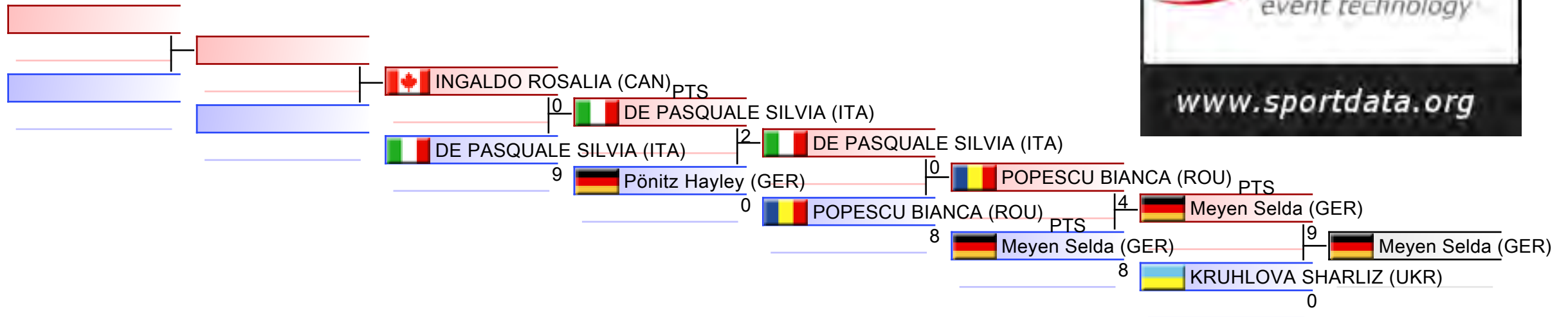

REPECHAGE: (4,3)

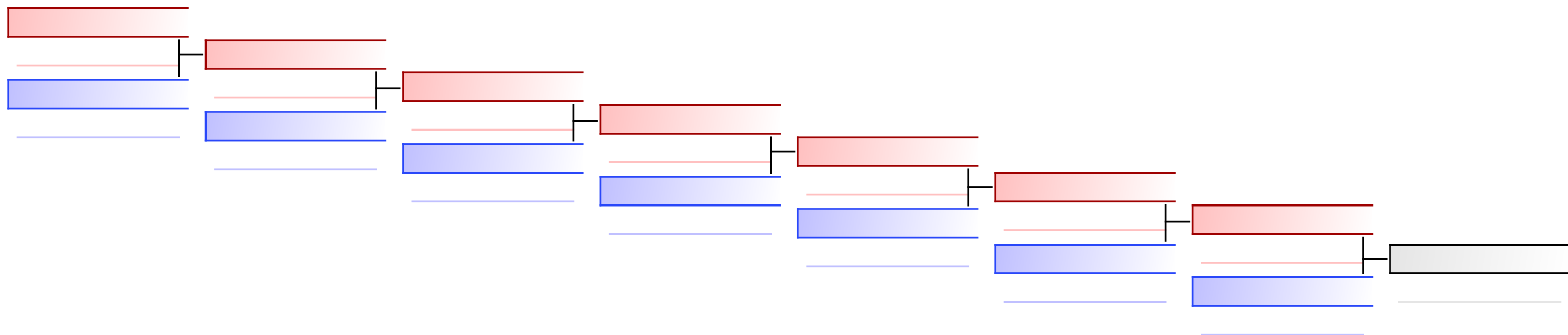



Karate1 Youth League - Venice 2024 - 2024-12-04



Official Results

U14 Kumite Female -52 kg (Entries: 81 Nations: 30)			
1	ARCALEAN MIHAELA		USA - UNITED STATES
2	STEFANSKI VANESSA		FIN - FINLAND
3	HARUTYUNYAN NANE		ARM - ARMENIA
3	MEYEN SELDA		GER - GERMANY
5	SHEVCHENKO KARYNA		UKR - UKRAINE
5	KRUHLOVA SHARLIZ		UKR - UKRAINE
7	PODLASZEWSKA KIRANA		GER - GERMANY
7	POPESCU BIANCA		ROU - ROMANIA
9	MAKSOVIĆ JOVANA		SRB - SERBIA
9	DE PASQUALE SILVIA		ITA - ITALY
11	VOIGT JOHANNA		GER - GERMANY
11	PÖNITZ HAYLEY		GER - GERMANY
13	SCARSI ALICE		ITA - ITALY
13	INGALDO ROSALIA		CAN - CANADA

U14 KUMITE FEMALE 52+ KG



Karate1 Youth League - Venice 2024

ENTRIES BY WEIGHT CATEGORY



U14 Kumite Female 52+ kg

As of 8 DEC 2024

Country Code	ID	Gender	Name	Seeding
AUT	AUT02960	F	Sandholzer Maya	
BIH		F	Alikadić Sajra	
BIH		F	Balić Berina	
BIH		F	BRKOVIC BERINA	
BIH		F	Bukva Ajsa	
BIH		F	Goran Hana	
BIH		F	Neziric Sajra	
BIH		F	Omanović Henna	
BIH		F	Omanović Lamija	
BIH		F	Raščić Zara	
BIH		F	Sarvan Ilma	
BIH		F	Šikanjić Jovana	
BUL		F	Georgieva Stefani	
CRO		F	Pejnović Alessia	
CZE		F	Horáková Klára	
CZE		F	Simpson Liliana	
CZE	CZE003001	F	SVOBODOVA ELISKA	
ENG		F	HANDLEY SKYLA	
ENG		F	Kumedzina Myla	
ENG		F	Simpson Codi	
ESP		F	GINÉS CHAVARRY PAULA	
ESP		F	VAZQUEZ GARCIA CECILIA	
FRA		F	LFAKIRI IKRAM	
GER		F	Becker Céline	
GER		F	Paulus Chayenne	
GER		F	Wybraniec Dana Ellen	
GRE	GRE003489	F	GEORGILA STYLIANI	
GRE		F	KOCHYLA DIMITRA VARVARA	
GRE	GRE003929	F	KOUROUVAKALI STYLIANI	
GRE	GRE003928	F	PAPADAKI MELINA	
GRE		F	Pergalia Agathi Agapi	
GRE		F	Pergalia Anastasia Eirini	
GRE	GRE003812	F	POLYKANDRIOTI ERIFYLI NIKOLETTA	
GRE	GRE03474	F	POLYKRETI ANASTASIA	
ITA		F	Addesa MariaLuisa	
ITA		F	Anderlini Anna Clara	
ITA		F	ARCILESI VIRGINIA	
ITA		F	BALLARIN GINEVRA	
ITA		F	BERTOLDO VERA	
ITA		F	Caridei Carola	
ITA		F	GAVIOLI MELISSA	
ITA		F	Genocchio Isabel	
ITA		F	MARINELLI GIULIA	
ITA		F	Ortuso Alessia Maria	
ITA		F	Passuello Caterina	



Karate1 Youth League - Venice 2024

ENTRIES BY WEIGHT CATEGORY



U14 Kumite Female 52+ kg

As of 8 DEC 2024

Country Code	ID	Gender	Name	Seeding
ITA		F	PEDRETTI ASIA	
ITA		F	PEZZOTTI ALESSIA	
ITA		F	Piantini Lara	
ITA		F	Rizzo Martina	
ITA		F	Stoppa Ginevra	
ITA		F	Zamberlan EMMA	
KOS	KOS03299	F	BEKOLLI OLTA	
KOS	KOS03363	F	KELMENDI ALEA	
KOS	KOS03298	F	SEJDIU REA	
LAT		F	Avruskina Jelizaveta	
LAT		F	Cernikova Darina	
LAT		F	Sevcika Vlada	
MDA	MDA002524	F	BIRIUC EVA	
MDA	MDA002540	F	SIRBU ALEXA	
NED	SD81138	F	Leurs Lily	
PER		F	Arias Polanco Ana Belén	
POL	POL07927	F	SARBA MALGORZATA	
POR		F	Pinto Matilde	
ROU	ROU03727	F	ANCUTA DOMINIQUE MARIA	
ROU	ROU03595	F	PRITA IANA IRINA	
SLO		F	MASTNAK MIA	
SRB		F	Djeric Maja	
SRB		F	Grujic Sofija	
SRB		F	Jovičić Anja	
SRB		F	Macura Nina	
SRB		F	Mirosavić Lena	
SUI		F	Marano Leonia Mya	
SVK		F	Cabanová Hanka	
SVK		F	KLEMPOVÁ Linda	
SVK		F	Šatalová Soňa	
TUR		F	ÇÜMEN ECE	
TUR		F	GUNDOGDU ECRİN	
TUR		F	OKUMUS CEYDA SU	
TUR		F	SARIKAYA YAREN ELİF	
UKR		F	Derevianko Anastasiia	
UKR		F	Ksondz Amieliia	
UKR		F	Malikova Karolina	
UKR		F	Malko Nadiia	
UKR		F	Mamalyha Marichka	
UKR		F	Nabok YEVA	
UKR		F	POPOVA DIANA	
UKR		F	Rudnikova Anastasiia	
UKR		F	Sheptiy Polina	
UKR		F	Trandasir AppolinariiA	
VEN		F	Angel Cote Deilimar Gabriela	



Karate1 Youth League - Venice 2024
ENTRIES BY WEIGHT CATEGORY



U14 Kumite Female 52+ kg

Karate1 Youth League - Venice 2024, PALAZZO DEL TURISMO, Piazza Brescia 11, 30016 Lido di Jesolo VE, ITA

2024-12-08

Tatami
1 16:30

Pool
1/4

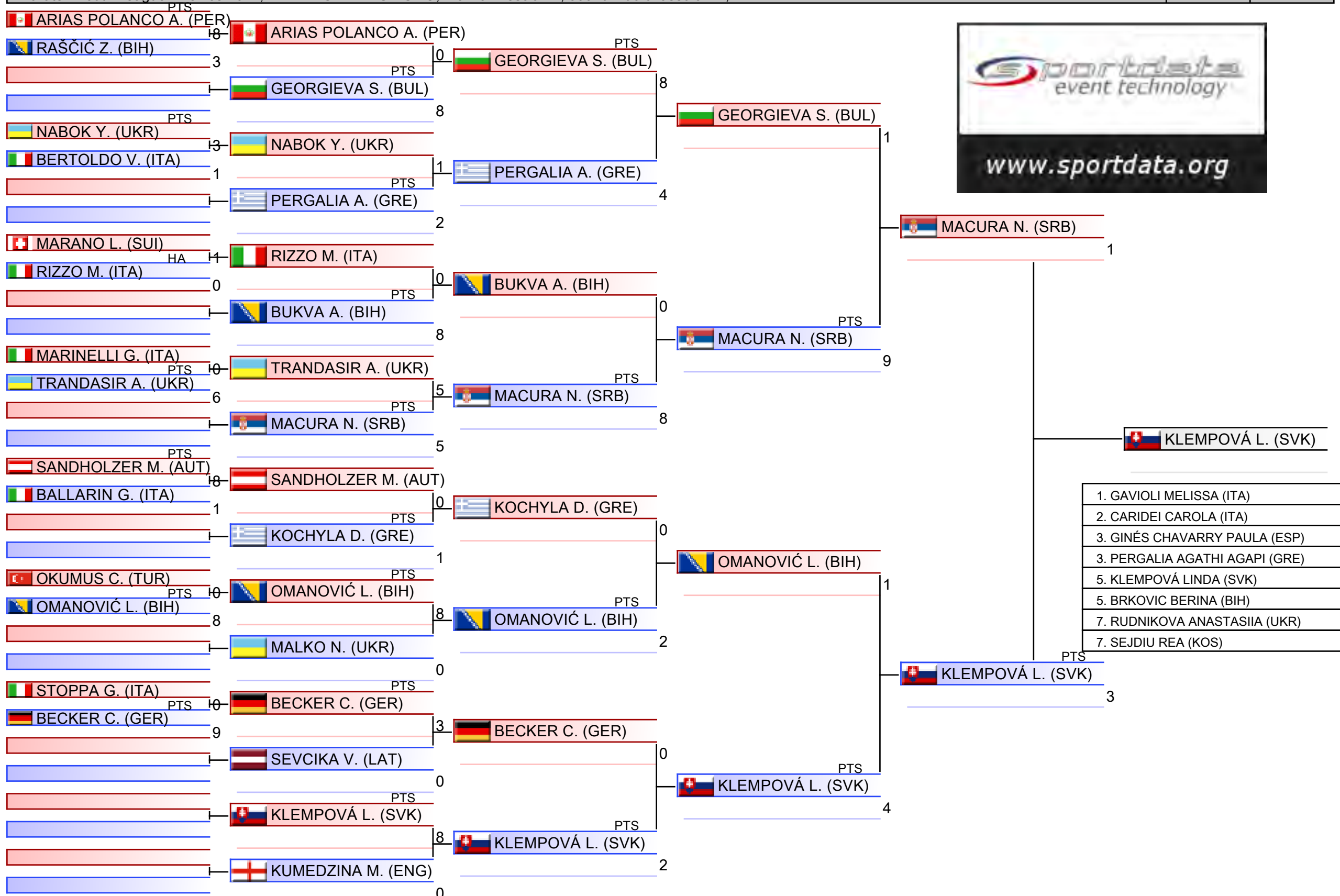

1. GAVIOLI MELISSA (ITA)
2. CARIDEI CAROLA (ITA)
3. GINÉS CHAVARRY PAULA (ESP)
3. PERGALIA AGATHI AGAPI (GRE)
5. KLEMPOVÁ LINDA (SVK)
5. BRKOVIC BERINA (BIH)
7. RUDNIKOVA ANASTASIIA (UKR)
7. SEJDIU REA (KOS)

U14 Kumite Female 52+ kg

Karate1 Youth League - Venice 2024, PALAZZO DEL TURISMO, Piazza Brescia 11, 30016 Lido di Jesolo VE, ITA

2024-12-08

Tatami
2 16:30

Pool
2/4

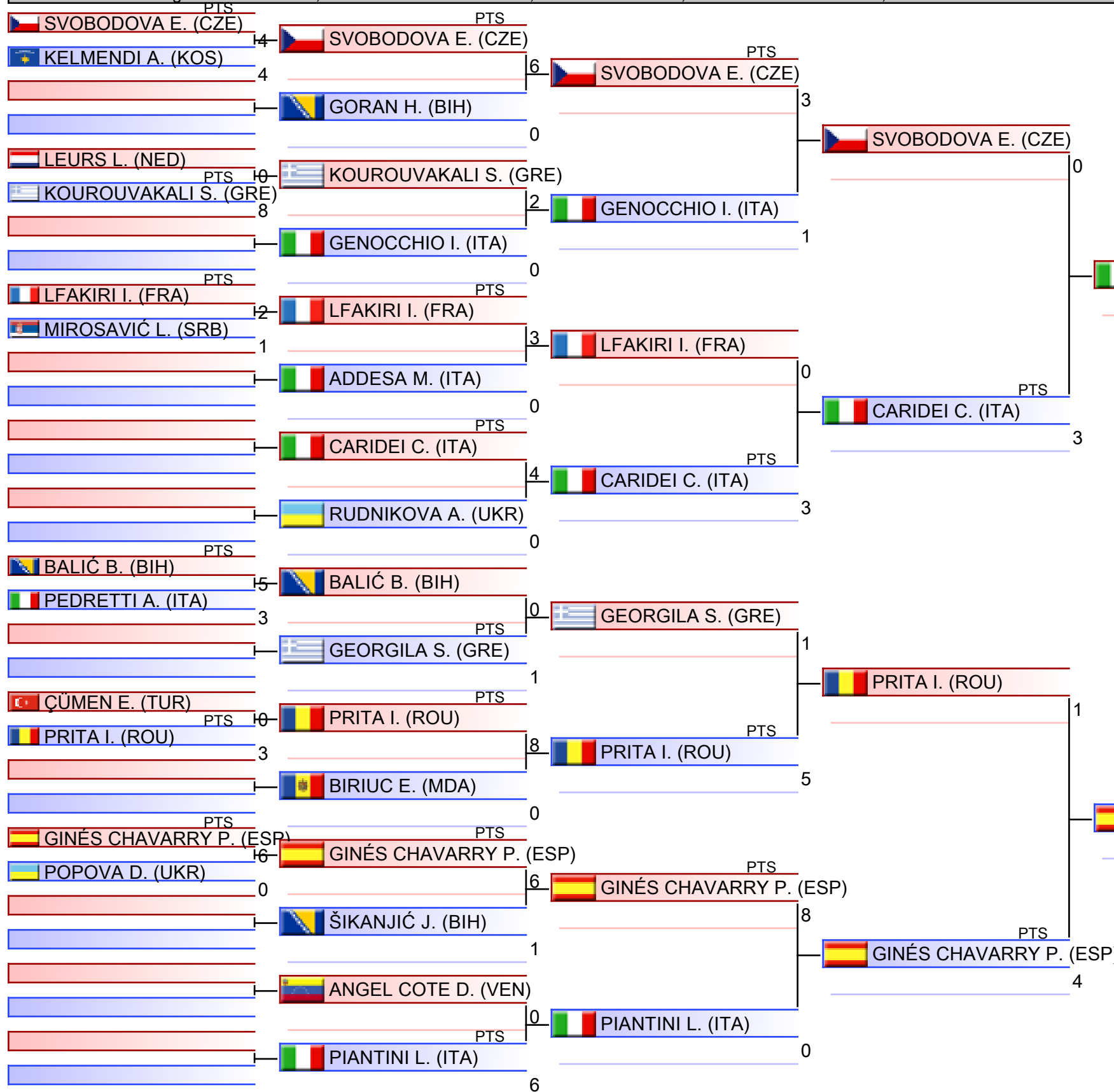

1. GAVIOLI MELISSA (ITA)
2. CARIDEI CAROLA (ITA)
3. GINÉS CHAVARRY PAULA (ESP)
3. PERGALIA AGATHI AGAPI (GRE)
5. KLEMPOVÁ LINDA (SVK)
5. BRKOVIC BERINA (BIH)
7. RUDNIKOVA ANASTASIIA (UKR)
7. SEJDIU REA (KOS)

U14 Kumite Female 52+ kg

Karate1 Youth League - Venice 2024, PALAZZO DEL TURISMO, Piazza Brescia 11, 30016 Lido di Jesolo VE, ITA

2024-12-08

Tatami
3 16:30

Pool
3/4

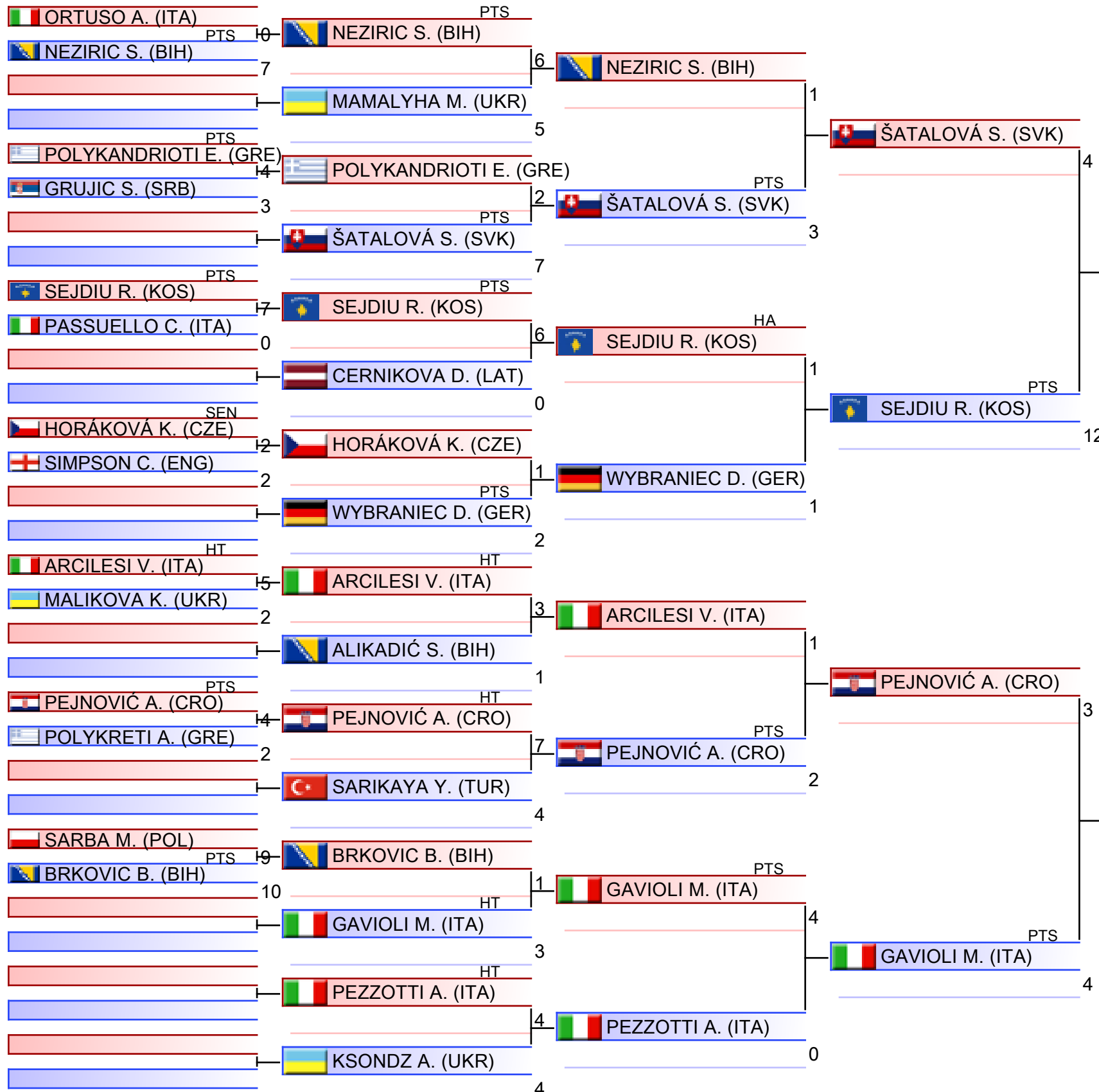

- | |
|--------------------------------|
| 1. GAVIOLI MELISSA (ITA) |
| 2. CARIDEI CAROLA (ITA) |
| 3. GINÉS CHAVARRY PAULA (ESP) |
| 3. PERGALIA AGATHI AGAPI (GRE) |
| 5. KLEMPOVÁ LINDA (SVK) |
| 5. BRKOVIC BERINA (BIH) |
| 7. RUDNIKOVA ANASTASIIA (UKR) |
| 7. SEJDIU REA (KOS) |

U14 Kumite Female 52+ kg

Karate1 Youth League - Venice 2024, PALAZZO DEL TURISMO, Piazza Brescia 11, 30016 Lido di Jesolo VE, ITA

2024-12-08

Tatami
4 16:30

Pool
4/4

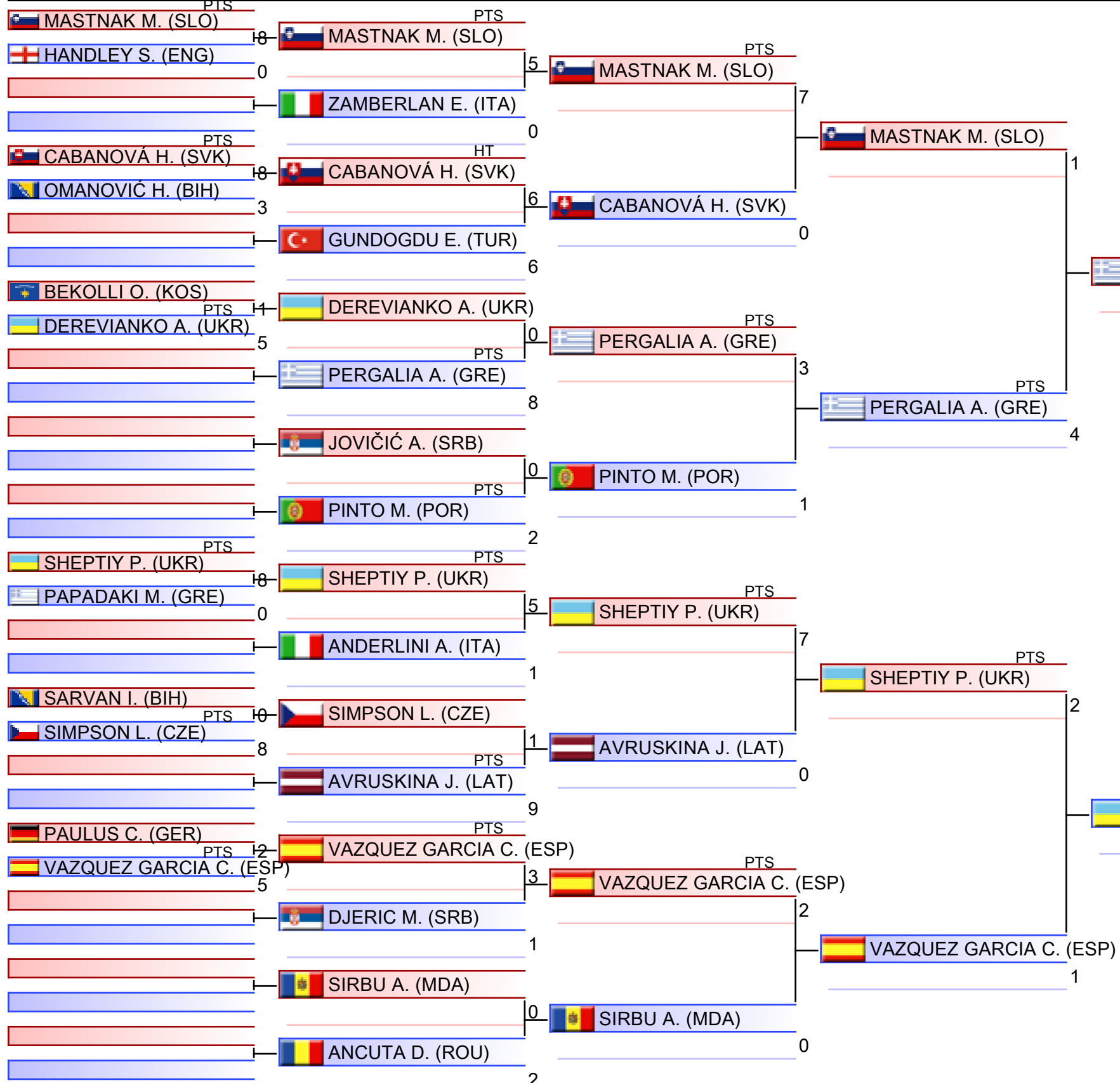

- | |
|--------------------------------|
| 1. GAVIOLI MELISSA (ITA) |
| 2. CARIDEI CAROLA (ITA) |
| 3. GINÉS CHAVARRY PAULA (ESP) |
| 3. PERGALIA AGATHI AGAPI (GRE) |
| 5. KLEMPOVÁ LINDA (SVK) |
| 5. BRKOVIC BERINA (BIH) |
| 7. RUDNIKOVA ANASTASIIA (UKR) |
| 7. SEJDIU REA (KOS) |

Pool winner-U14 Kumite Female 52+ kg

Karate1 Youth League - Venice 2024, PALAZZO DEL TURISMO, Piazza Brescia 11, 30016 Lido di Jesolo VE, ITA

2024-12-08

Tatami
1 18:10

Pool
1/1

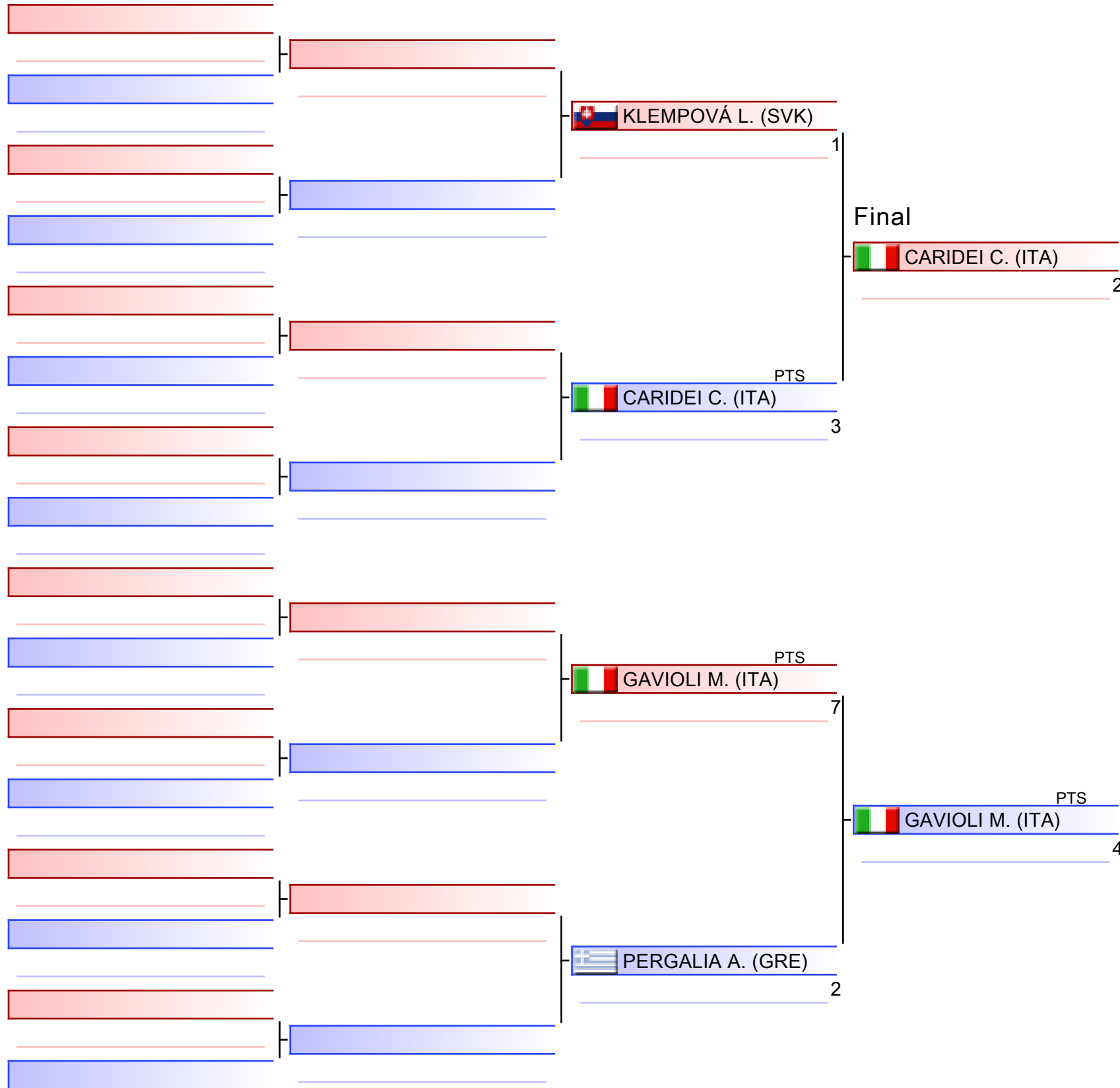

GAVIOLI M. (ITA)

1. GAVIOLI MELISSA (ITA)
2. CARIDEI CAROLA (ITA)
3. GINÉS CHAVARRY PAULA (ESP)
3. PERGALIA AGATHI AGAPI (GRE)
5. KLEMPOVÁ LINDA (SVK)
5. BRKOVIC BERINA (BIH)
7. RUDNIKOVA ANASTASIIA (UKR)
7. SEJDIU REA (KOS)

U14 Kumite Female 52+ kg

Karate1 Youth League - Venice 2024

2024-12-08

Tatami

1 18:15

Pool

1,2

(c)sportdata GmbH & Co KG 2000-2024 (2024-12-08 20:16) v 10.2.0 build 1 (2024-11-20 00:58 CET) License: SDIL TVG (expire 2025-01-26)

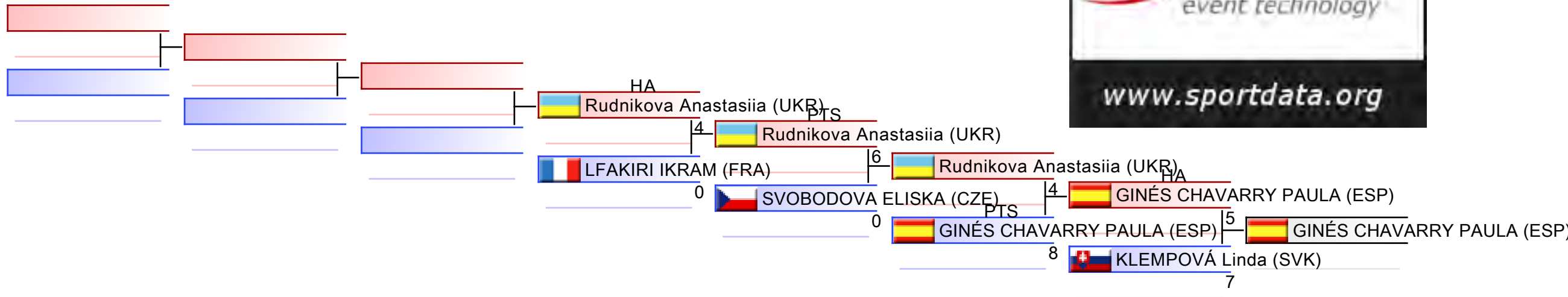

REPECHAGE: (1,2)

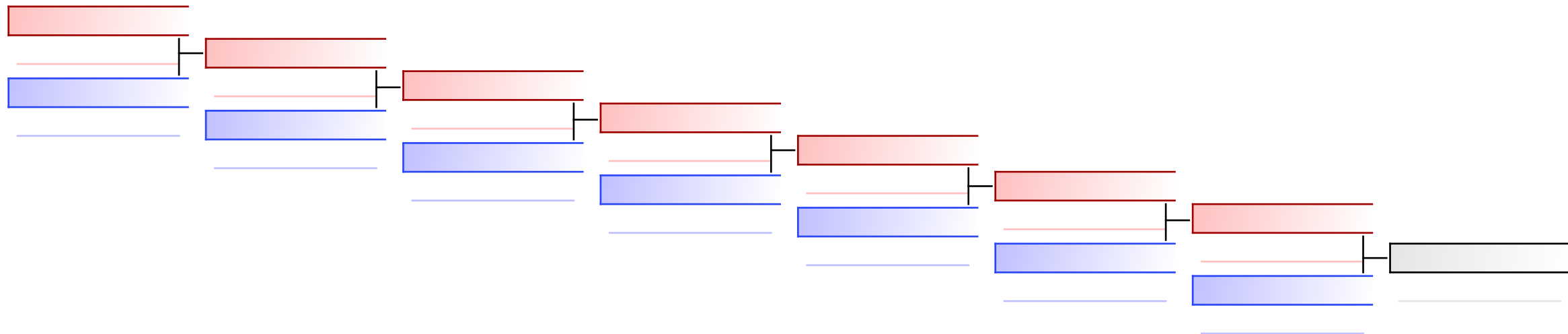

U14 Kumite Female 52+ kg

Karate1 Youth League - Venice 2024

2024-12-08

Tatami
2 18:15

Pool
3,4

(c)sportdata GmbH & Co KG 2000-2024 (2024-12-08 20:16) v 10.2.0 build 1 (2024-11-20 00:58 CET) License: SDIL TVG (expire 2025-01-26)

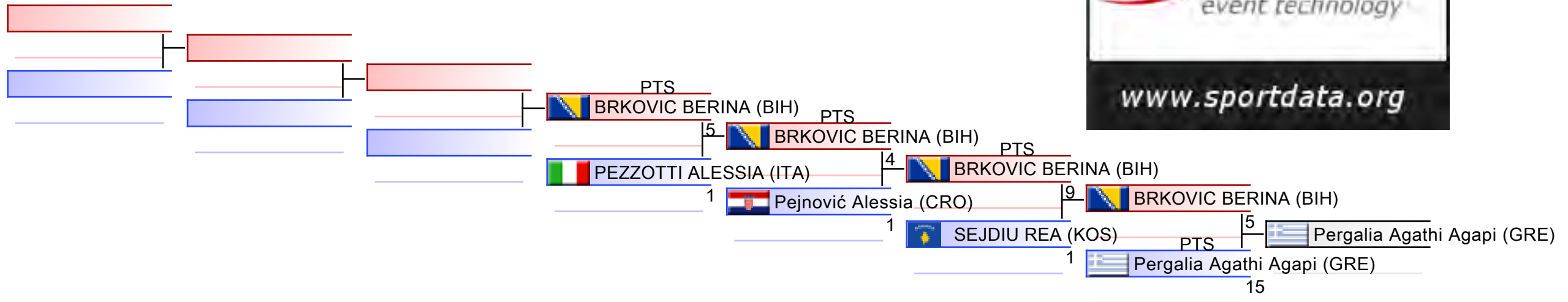

REPECHAGE: (3,4)

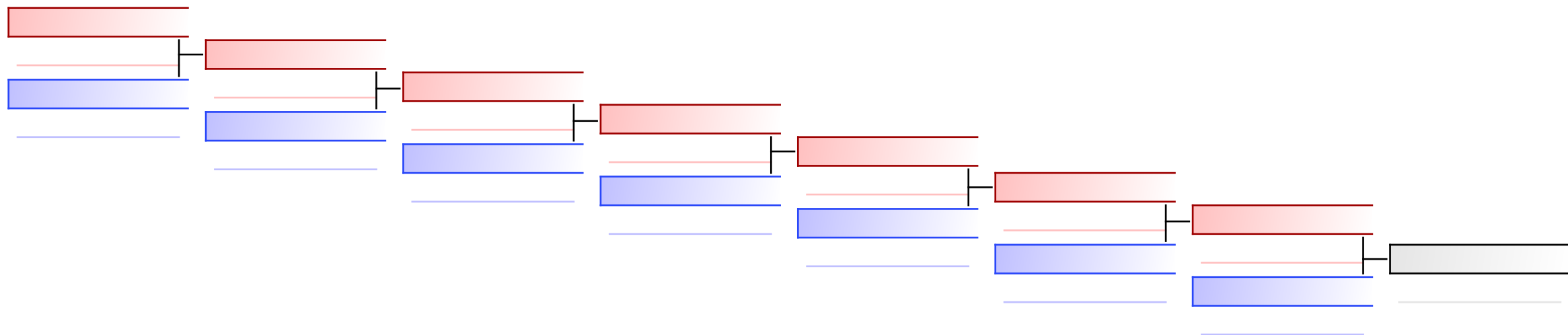



Karate1 Youth League - Venice 2024 - 2024-12-04



Official Results

U14 Kumite Female 52+ kg (Entries: 90 Nations: 26)			
1	GAVIOLI MELISSA		ITA - ITALY
2	CARIDEI CAROLA		ITA - ITALY
3	GINÉS CHAVARRY PAULA		ESP - SPAIN
3	PERGALIA AGATHI AGAPI		GRE - GREECE
5	KLEMPOVÁ LINDA		SVK - SLOVAKIA
5	BRKOVIC BERINA		BIH - BOSNIA AND HERZEGOVINA
7	RUDNIKOVA ANASTASIIA		UKR - UKRAINE
7	SEJDIU REA		KOS - KOSOVO
9	SVOBODOVA ELISKA		CZE - CZECH REPUBLIC
9	PEJNOVIĆ ALESSIA		CRO - CROATIA
11	LFAKIRI IKRAM		FRA - FRANCE
11	PEZZOTTI ALESSIA		ITA - ITALY

U14 KUMITE MALE +55 KG



Karate1 Youth League - Venice 2024

ENTRIES BY WEIGHT CATEGORY



U14 Kumite Male +55 kg

As of 8 DEC 2024

Country Code	ID	Gender	Name	Seeding
AUS	AUS02740	M	JAHIU DARDAN	
AZE	AZE02600	M	SEMIKHOV MARAT	
BEL		M	Chakhter Amin	
BIH		M	Hercegovac Tarik	
BIH		M	Hodžić Adin	
BIH		M	Šakinović Adnan	
BIH		M	Selava Ferid	
BIH		M	Serdar Filip	
BIH		M	Vuksan David	
BIH		M	Zundja Amir	
BIH		M	Zundja Emir	
BUL		M	Kateliiev Bozhidar	
BUL		M	KOKONOV ROSTISLAV	
CAN		M	Oldford Grayson	
CRO	CRO03966	M	VUCAK DAVID	
CYP		M	ROUSSOS KYRIACOS	
CZE	CZE02723	M	MALY MARCEL	
CZE		M	Škoudlil David	
CZE		M	Větr Samuel	
ENG		M	Breeds Henry	
GER		M	Azadi Bijan	
GER		M	Gräfe Lukas	
GRE	GRE003935	M	GEORGILAS ZACHARIAS	
HUN		M	Bali Tibor	
HUN		M	Kis Mátyás	
IRL	IRL003055	M	MCGLYNN MICHAEL	
ITA		M	BUONDONNO MANUEL	
ITA		M	Caiata Antonio	
ITA		M	Capizzi Michele	
ITA		M	Castellazzi Simone	
ITA		M	CUPCEA NIKITA	
ITA		M	Di ciommo Luca	
ITA		M	FILIPPI GABRIELE	
ITA		M	FOTINO SAMUELE	
ITA		M	Guderzo Francesco	
ITA		M	Iacob Alessio	
ITA		M	Marino Antonio	
ITA		M	Moretti Leonardo	
ITA		M	Mungiguerra Giuseppe	
ITA		M	Naglein Giorgio	
ITA		M	NICCHI SAMUELE	
ITA		M	PAGANO CARMINE	
ITA		M	Pascale Bruno	
ITA		M	Piccinini Giulio	
ITA		M	Pinna Maurizio	



Karate1 Youth League - Venice 2024

ENTRIES BY WEIGHT CATEGORY



U14 Kumite Male +55 kg

As of 8 DEC 2024

Country Code	ID	Gender	Name	Seeding
ITA		M	QUARANTA ANDREA	
ITA		M	QUINTAVALLE GABRIELE	
ITA		M	ROSSANO ANTONIO CLAUDIO	
ITA		M	SCARICO MARIO	
ITA		M	SCUGLIA MASSIMO	
ITA		M	Spartà Alessio	
ITA		M	STORNAIUOLO GAETANO	
ITA		M	TASSONE CALDIN ALVISE	
ITA		M	Uccellari Ludovico	
ITA		M	Vampa Gabriel	
ITA		M	Venosta Fabio	
LAT		M	Milovs Deniss	
MDA	MDA002529	M	COLOSIUC PROHOR	
MLT	MLT002362	M	GRECH JADEN	
NED		M	van de Nes Dinand	
PER	PER002830	M	BORJAS SILVA MATHIAS MIGUEL	
POL	POL08785	M	DABEK MACIEJ	
POL	POL10793	M	Kołata Borys	
ROU	ROU003863	M	EDUARD MARIAN RADU	
ROU	ROU03620	M	OSTAFIE MANDRES CRISTIAN ANDREI	
SRB		M	Jevremovic Svetislav	
SRB		M	Jovanovic Ognjen	
SRB		M	Vasiljević Strahinja	
SRB		M	Vujičić Jug	
SRB		M	Zivkovic Ilija	
SUI		M	Kühl Bjärne	
SVK		M	Cimerman Samuel	
SVK		M	Leštinský Michal	
SVK		M	Lopatka Martin	
SWE		M	Andersson Jöhnk Emil	
TUR		M	Kılıç Kaan Emre	
TUR		M	ÖZDEN ÖMER ALPEREN	
TUR		M	TAŞ ILGAZ	
UKR		M	Baiol Mykola	
UKR		M	Barbadyn Roman	
UKR		M	GRES PLATON	
UKR		M	Hromovyi Ruslan	
UKR		M	Leshchuk Yehor	
UKR		M	Lypivskyi Daniil	
UKR		M	MUZYCHKA USTYM	
UKR		M	Osadchyi Semen	
UKR		M	Pomeranets Ihor	
UKR		M	POTAPOV ARTEM	
UKR		M	Tahiev Yevhen	

U14 Kumite Male +55 kg

Karate1 Youth League - Venice 2024, PALAZZO DEL TURISMO, Piazza Brescia 11, 30016 Lido di Jesolo VE, ITA

2024-12-08

Tatami
5 11:30

Pool
1/4

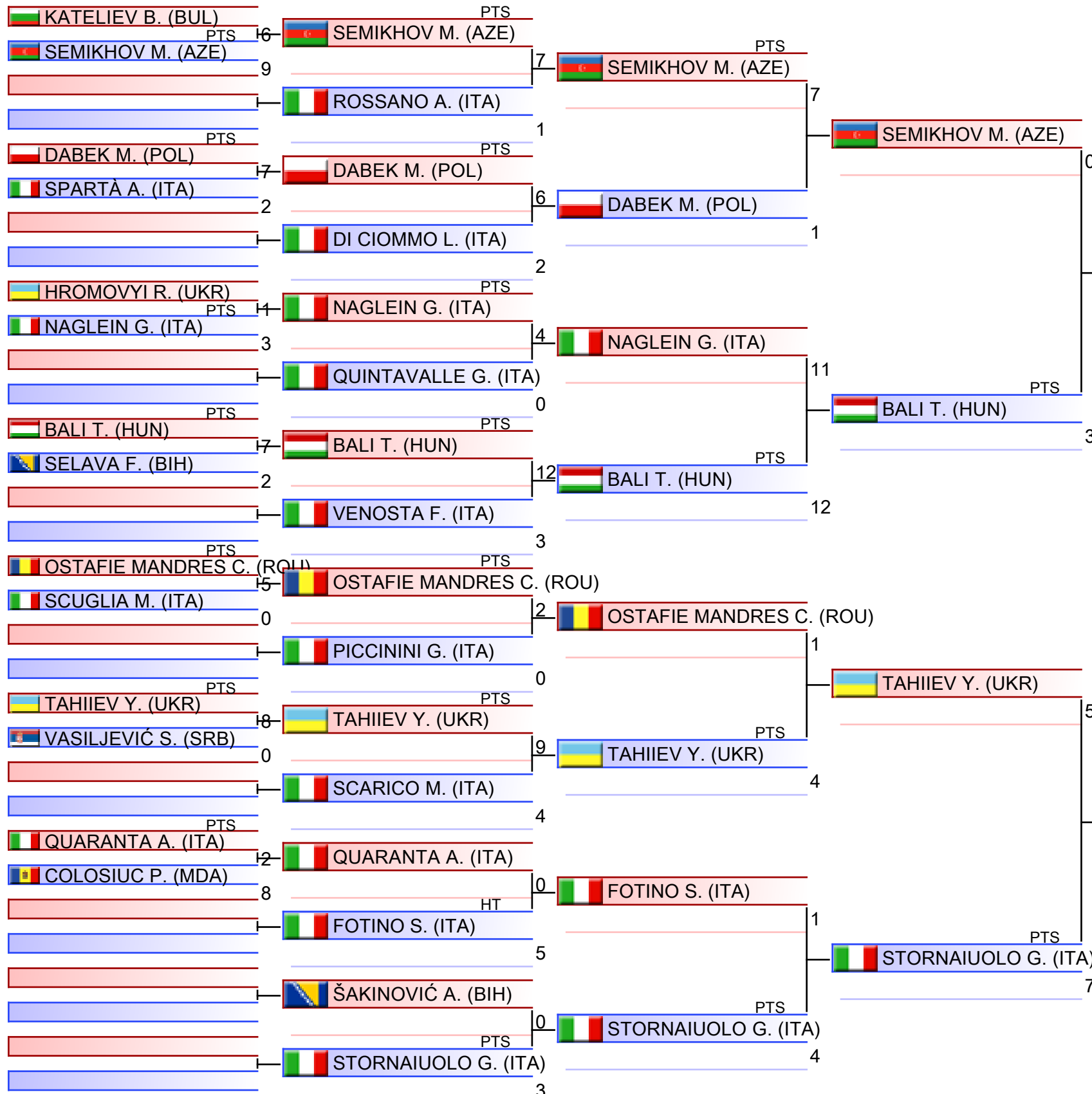

1. AZADI BIJAN (GER)
2. LYPIVSKYI DANIIEV (UKR)
3. STORNAIUOLO GAETANO (ITA)
3. MCGLYNN MICHAEL (IRL)
5. CHAKHTER AMIN (BEL)
5. CAPIZZI MICHELE (ITA)
7. BORJAS SILVA MATHIAS MIGUEL (PER)
7. TAŞ ILGAZ (TUR)

U14 Kumite Male +55 kg

Karate1 Youth League - Venice 2024, PALAZZO DEL TURISMO, Piazza Brescia 11, 30016 Lido di Jesolo VE, ITA

2024-12-08

Tatami
6 11:30

Pool
2/4

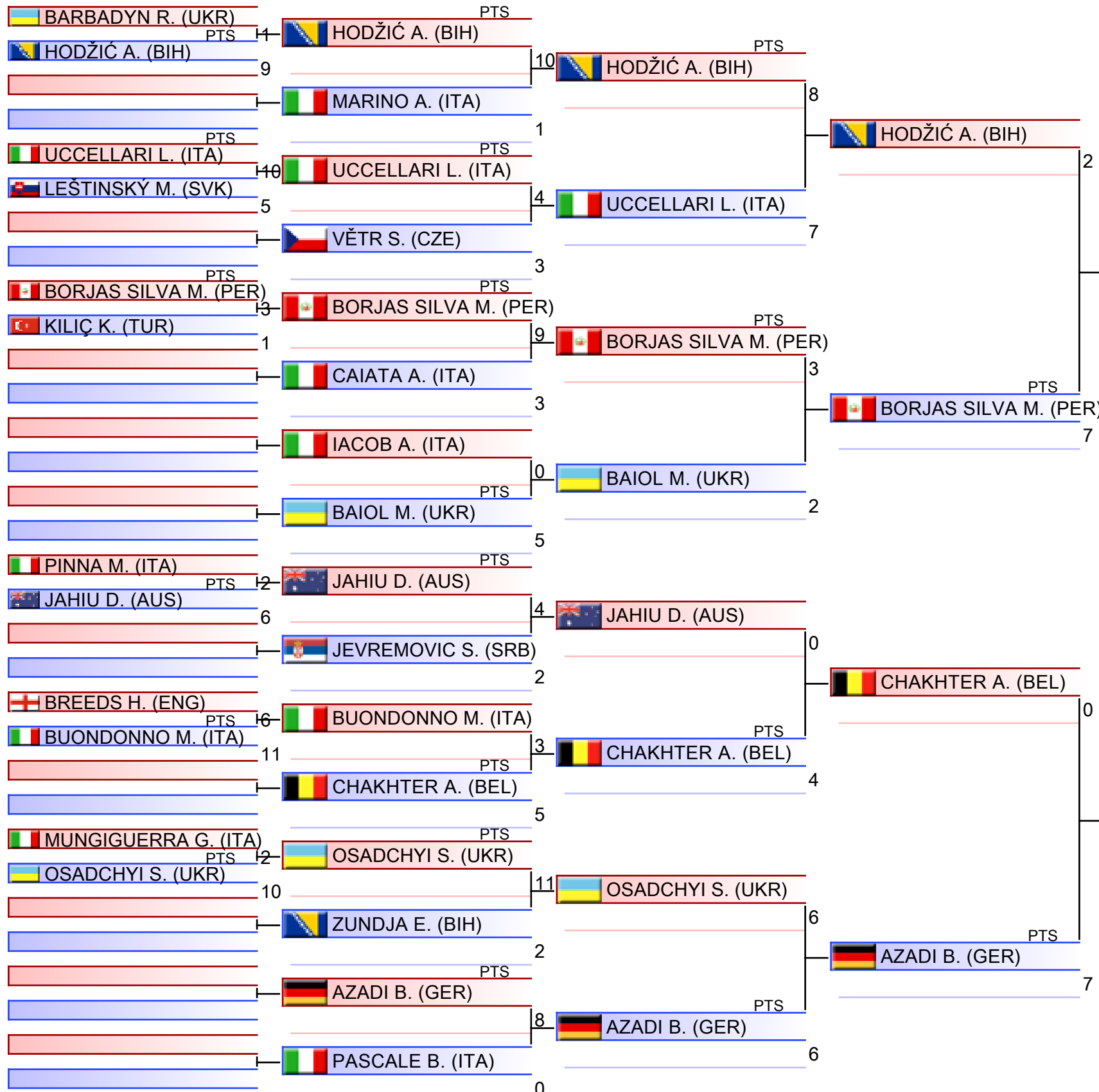

1. AZADI BIJAN (GER)
2. LYPIVSKYI DANIEL (UKR)
3. STORNAIUOLO GAETANO (ITA)
3. MCGLYNN MICHAEL (IRL)
5. CHAKHTER AMIN (BEL)
5. CAPIZZI MICHELE (ITA)
7. BORJAS SILVA MATHIAS MIGUEL (PER)
7. TAŞ ILGAZ (TUR)

U14 Kumite Male +55 kg

Karate1 Youth League - Venice 2024, PALAZZO DEL TURISMO, Piazza Brescia 11, 30016 Lido di Jesolo VE, ITA

2024-12-08

Tatami
7 11:30

Pool
3/4

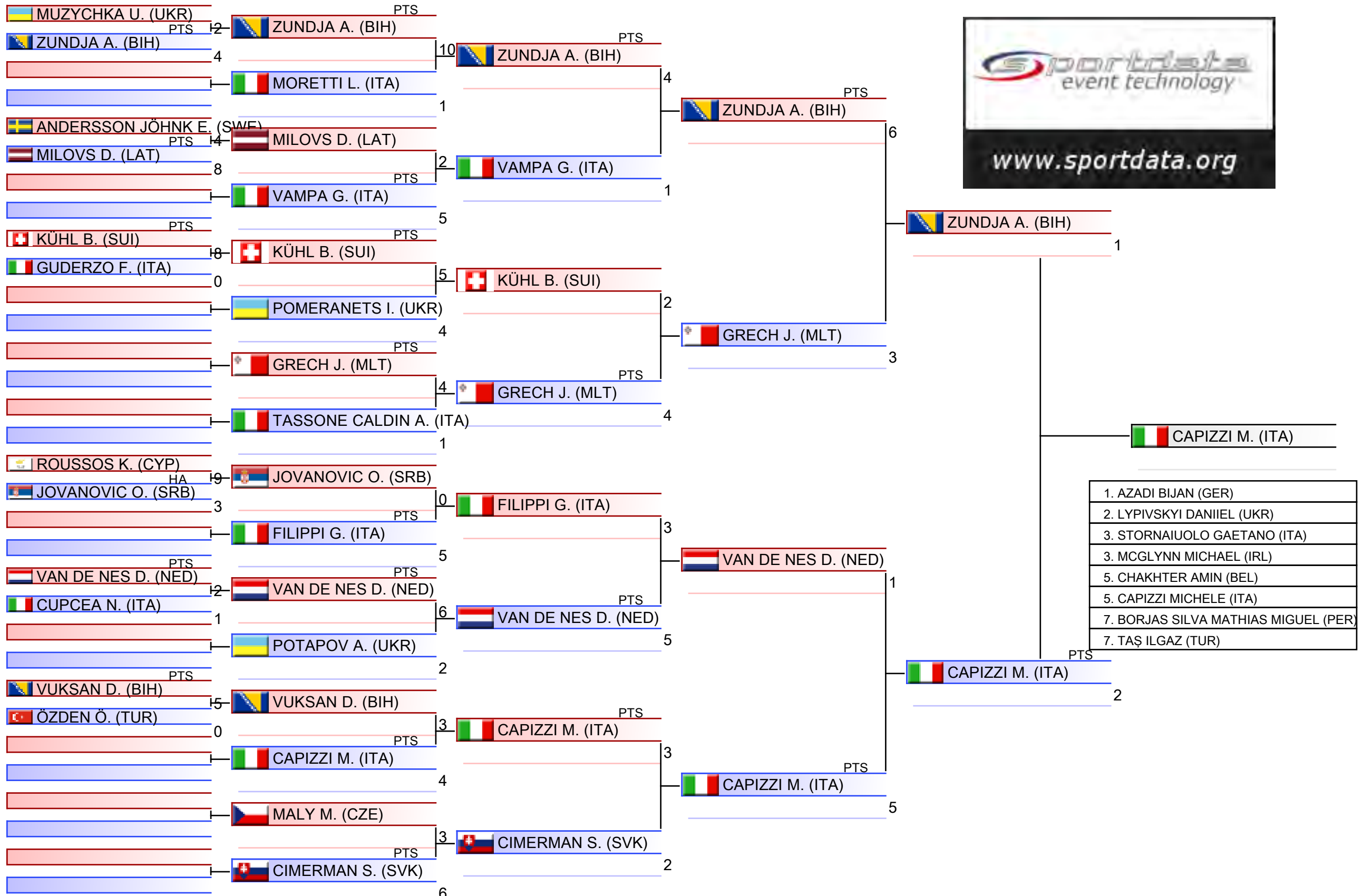

U14 Kumite Male +55 kg

Karate1 Youth League - Venice 2024, PALAZZO DEL TURISMO, Piazza Brescia 11, 30016 Lido di Jesolo VE, ITA

2024-12-08

Tatami
8 11:30

Pool
4/4

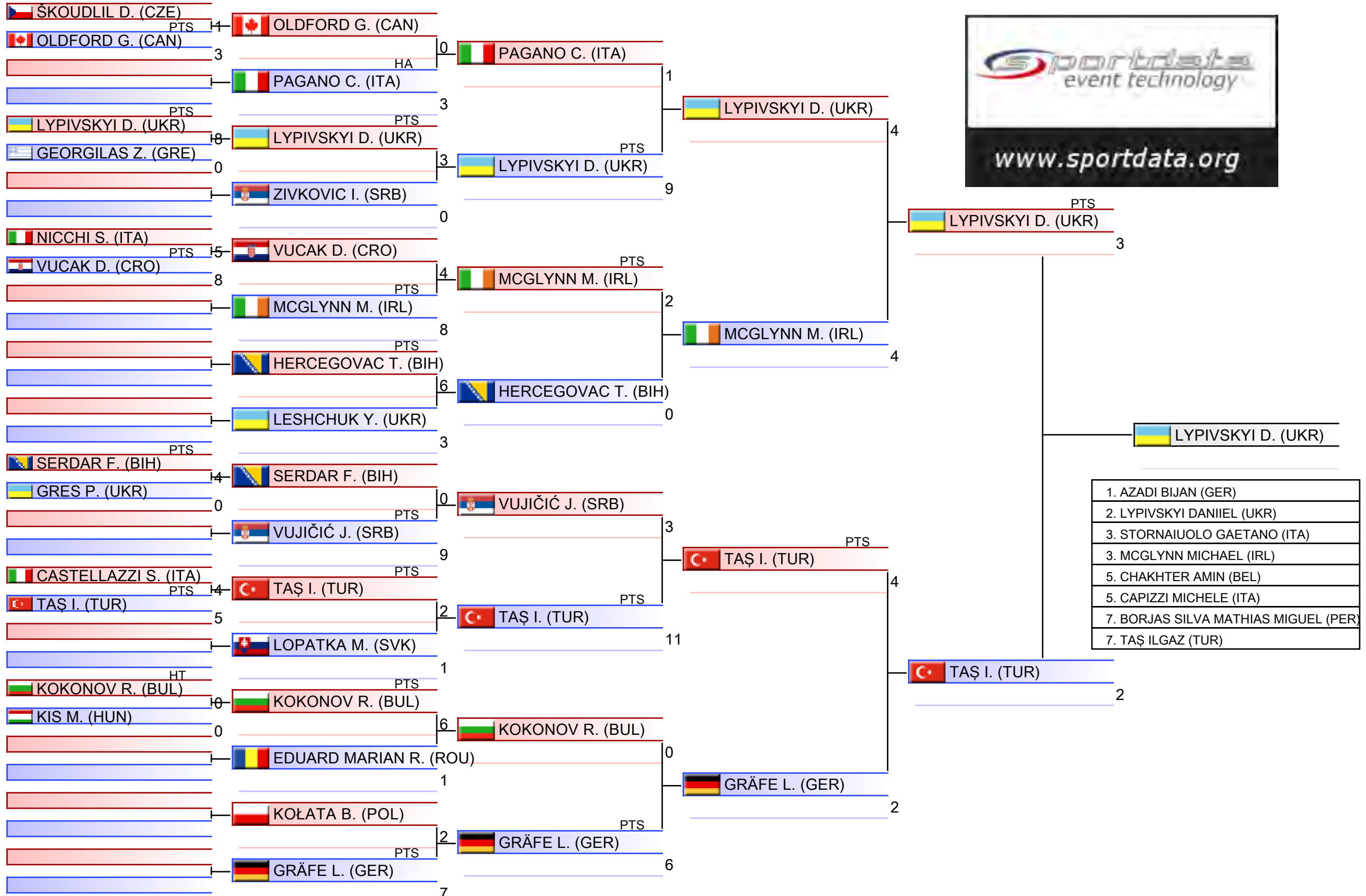

- | |
|--------------------------------------|
| 1. AZADI BIJAN (GER) |
| 2. LYPIVSKYI DANIEL (UKR) |
| 3. STORNAIUOLO GAETANO (ITA) |
| 3. MCGLYNN MICHAEL (IRL) |
| 5. CHAKHTER AMIN (BEL) |
| 5. CAPIZZI MICHELE (ITA) |
| 7. BORJAS SILVA MATHIAS MIGUEL (PER) |
| 7. TAŞ ILGAZ (TUR) |

Pool winner-U14 Kumite Male +55 kg

Karate1 Youth League - Venice 2024, PALAZZO DEL TURISMO, Piazza Brescia 11, 30016 Lido di Jesolo VE, ITA

2024-12-08

Tatami

5 13:05

Pool

1/1

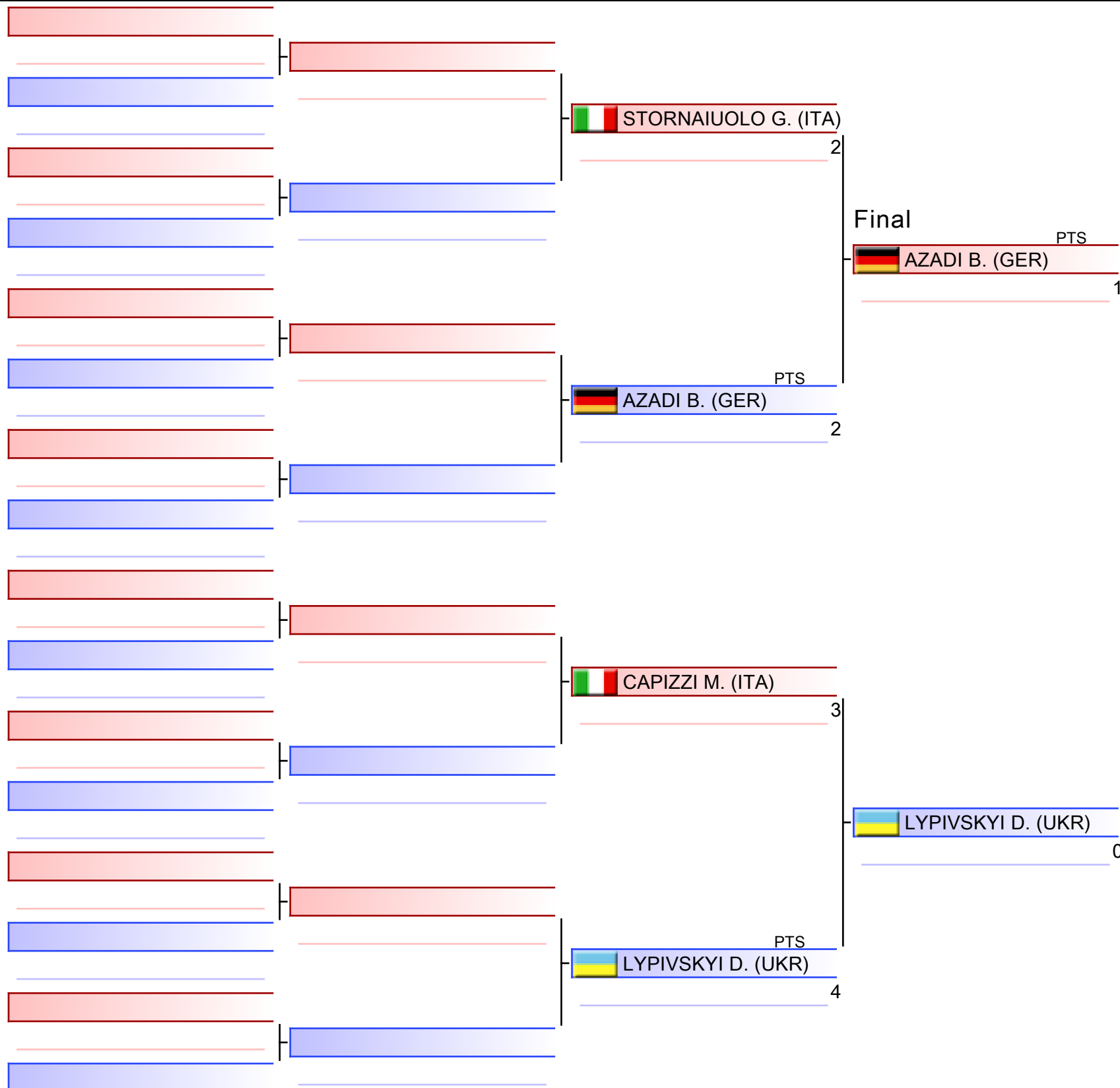

AZADI B. (GER)

1. AZADI BIJAN (GER)
2. LYPIVSKYI DANIEL (UKR)
3. STORNAIUOLO GAETANO (ITA)
3. MCGLYNN MICHAEL (IRL)
5. CHAKHTER AMIN (BEL)
5. CAPIZZI MICHELE (ITA)
7. BORJAS SILVA MATHIAS MIGUEL (PER)
7. TAŞ ILGAZ (TUR)

U14 Kumite Male +55 kg

Karate1 Youth League - Venice 2024

2024-12-08

Tatami

2 15:45

Pool

1,2,3,4

(c)sportdata GmbH & Co KG 2000-2024 (2024-12-08 20:16) v 10.2.0 build 1 (2024-11-20 00:58 CET) License: SDIL TVG (expire 2025-01-26)

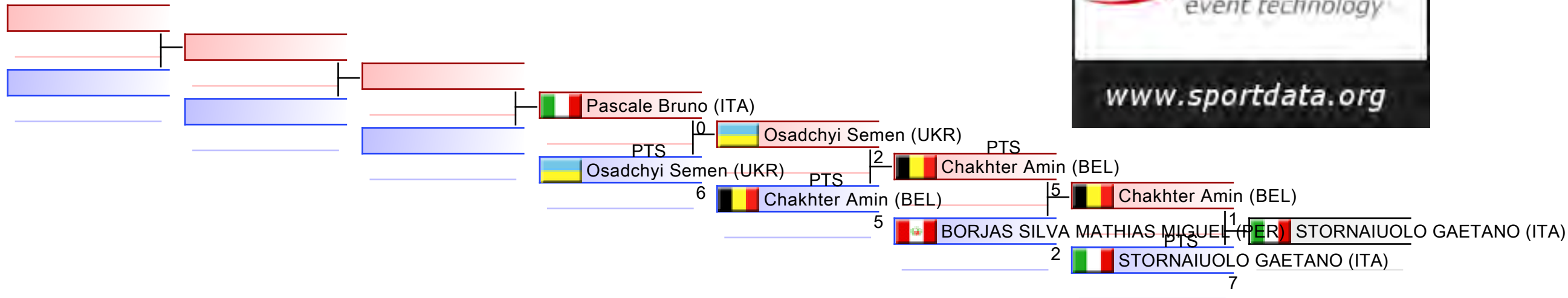

REPECHAGE: (1,2,3,4)

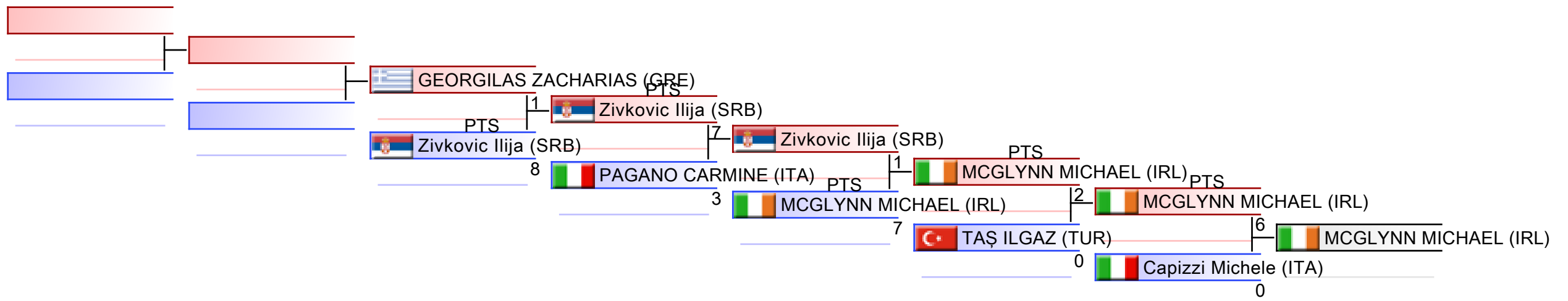



Karate1 Youth League - Venice 2024 - 2024-12-04



Official Results

U14 Kumite Male +55 kg (Entries: 89 Nations: 28)			
1	AZADI BIJAN		GER - GERMANY
2	LYPIVSKYI DANIIL		UKR - UKRAINE
3	STORNAIUOLO GAETANO		ITA - ITALY
3	MCGLYNN MICHAEL		IRL - IRELAND
5	CHAKHTER AMIN		BEL - BELGIUM
5	CAPIZZI MICHELE		ITA - ITALY
7	BORJAS SILVA MATHIAS MIGUEL		PER - PERU
7	TAŞ ILGAZ		TUR - TURKIYE
9	OSADCHYI SEMEN		UKR - UKRAINE
9	ZIVKOVIC ILIJA		SRB - SERBIA
11	PASCALE BRUNO		ITA - ITALY
11	PAGANO CARMINE		ITA - ITALY
13	GEORGILAS ZACHARIAS		GRE - GREECE

U14 KUMITE MALE -40 KG



Karate1 Youth League - Venice 2024

ENTRIES BY WEIGHT CATEGORY



U14 Kumite Male -40 kg

As of 8 DEC 2024

Country Code	ID	Gender	Name	Seeding
ARM	ARM003057	M	GOR SHAMIRYAN	
ARM	ARM02961	M	KIRAKOSYAN ARSEN	
AUT		M	Ebner Fabio	
BEL		M	Degée Louis	
BEL		M	Dernoncourt Sofiane	
BEL		M	GRANDJEAN HUGO	
BEL		M	Palm Lucas	
BEL		M	PETRY HUGO	
BEL		M	Zakhnini Imrane	
BIH		M	Fazlić Nedim	
BIH		M	Gradinčić Vedad	
BIH		M	Palić Kenan	
BIH		M	Šečić Hasan	
BIH		M	Zolota Ibrahim	
BUL		M	Kolev Denislav	
CHI		M	Sotomayor Villaroel Benjamin	
CRO		M	Nekić Stjepan	
CYP		M	CHALOFTIS CHRISTOS	
CYP		M	POUMPOURIDIS VALERIOS	
CZE	CZE003000	M	SVOBODA SIMON	
CZE		M	Tojšl Filip	
ENG		M	HOWARD LONDON-JAMES	
ENG		M	StClair Malachi	
ESP		M	escutia manchola Salvador	
FRA		M	BELFILALI OTMANE MOHAMED	
FRA		M	METENIER ROMAIN	
GEO	GEO02812	M	GABRAVA ILIA	
GER		M	Damiani Danilo	
GER		M	Eckerdt Daniel	
GER		M	Karaca Ilyas	
GRE		M	BOUSIKAS KYRIAKAKIS ELEFThERIOS	
GRE	GRE03073	M	STAVROULAKIS ILIAS	
HUN		M	Pap Dominik	
ITA		M	Bergna Lorenzo	
ITA		M	Berton Simone	
ITA		M	Biggiogero Matteo	
ITA	ITA506861	M	COERO ANDREA	
ITA		M	COSTANZO ANDREA	
ITA		M	Dignoti Sebastiano	
ITA		M	Di Naro Gabriele	
ITA		M	Gullo Giuseppe Gianmatteo	
ITA		M	Moffa Antonio	
ITA		M	MORESCO Andrea	
ITA		M	SCRIMIERI ANTONIO	
ITA	SD66418	M	Somaschini Filippo	



Karate1 Youth League - Venice 2024

ENTRIES BY WEIGHT CATEGORY



U14 Kumite Male -40 kg
As of 8 DEC 2024

Country Code	ID	Gender	Name	Seeding
ITA		M	Sportella Raffaele	
ITA		M	Todesca Alfonso	
KOS	KOS03355	M	DAKU AMAR	
KOS	KOS03304	M	DALIPI MEVLAN	
KOS	KOS02928	M	KRASNIQI ANUAR	
LAT		M	Marimpolskyi Bohdan	
LAT		M	Mētra Rūdofls	
LAT		M	Stilba Mihails	
MDA	MDA02303	M	URSAC PETRU	
MDA	MDA002538	M	YAKOVENIUK YAROMYR	
POL	POL09385	M	CUPRYJAK DANIEL	
POL	POL06140	M	FALKOWSKI PATRYK	
POL	POL06812	M	KRAWIEC KRZYSZTOF	
POL	POL10839	M	LEBEDIANSKYI DMITRO	
POR		M	Rebelo Tiago	
ROU	ROU03703	M	ANDREI EDUARD MIHAI	
ROU	ROU03624	M	BURLACU DRAGOS	
ROU	ROU003978	M	PETRU STAICU CALINESCU	
ROU	ROU003977	M	RADU ANDREI RUSU	
SUI		M	Häusermann Aaron	
SUI		M	Meier Nikita	
SVK		M	Maňúr Jakub	
SVK		M	Rumanovsky Lukáš	
SWE		M	Mustafa Hassan	
TKM	TKM02328	M	SAPADURDYEV OVEZMYRAT	
TUR		M	BEKTAŞ KAĞAN BERK	
TUR		M	Coşkun Fevzi Emir	
TUR		M	TÜKEN İBRAHİM HALİL	
UKR		M	BONDUR VLADYSLAV	
UKR		M	Chubun Nazar	
UKR		M	Fedorchak Maksym	
UKR		M	Hlushku Nikita	
UKR		M	Hrebenozhko Danylo	
UKR		M	KHODAKOVSKYI YEVSEVII	
UKR		M	Kunitskyi Oleh	
UKR		M	LIESKOVSYI ILLIA	
UKR		M	Malchenko Heorhii	
UKR		M	Melnyk Yevhenii	
UKR		M	MIKHNO MARK	
UKR		M	Moroz Borys	
UKR		M	RUDENKO KLYMENTII	
UKR		M	SEIKO VOLODYMYR	
UKR		M	Shulha Vadym	
UKR		M	Stepanov Tymur	
UKR		M	VASYLENKO VLADYSLAV	



Karate1 Youth League - Venice 2024
ENTRIES BY WEIGHT CATEGORY



U14 Kumite Male -40 kg
As of 8 DEC 2024

Country Code	ID	Gender	Name	Seeding
UKR		M	Zhmurenko Ivan	
USA		M	Levin Alexander	
VEN		M	Pinto Diego	

U14 Kumite Male -40 kg

Karate1 Youth League - Venice 2024, PALAZZO DEL TURISMO, Piazza Brescia 11, 30016 Lido di Jesolo VE, ITA

2024-12-08

Tatami
1 12:15

Pool
1/4

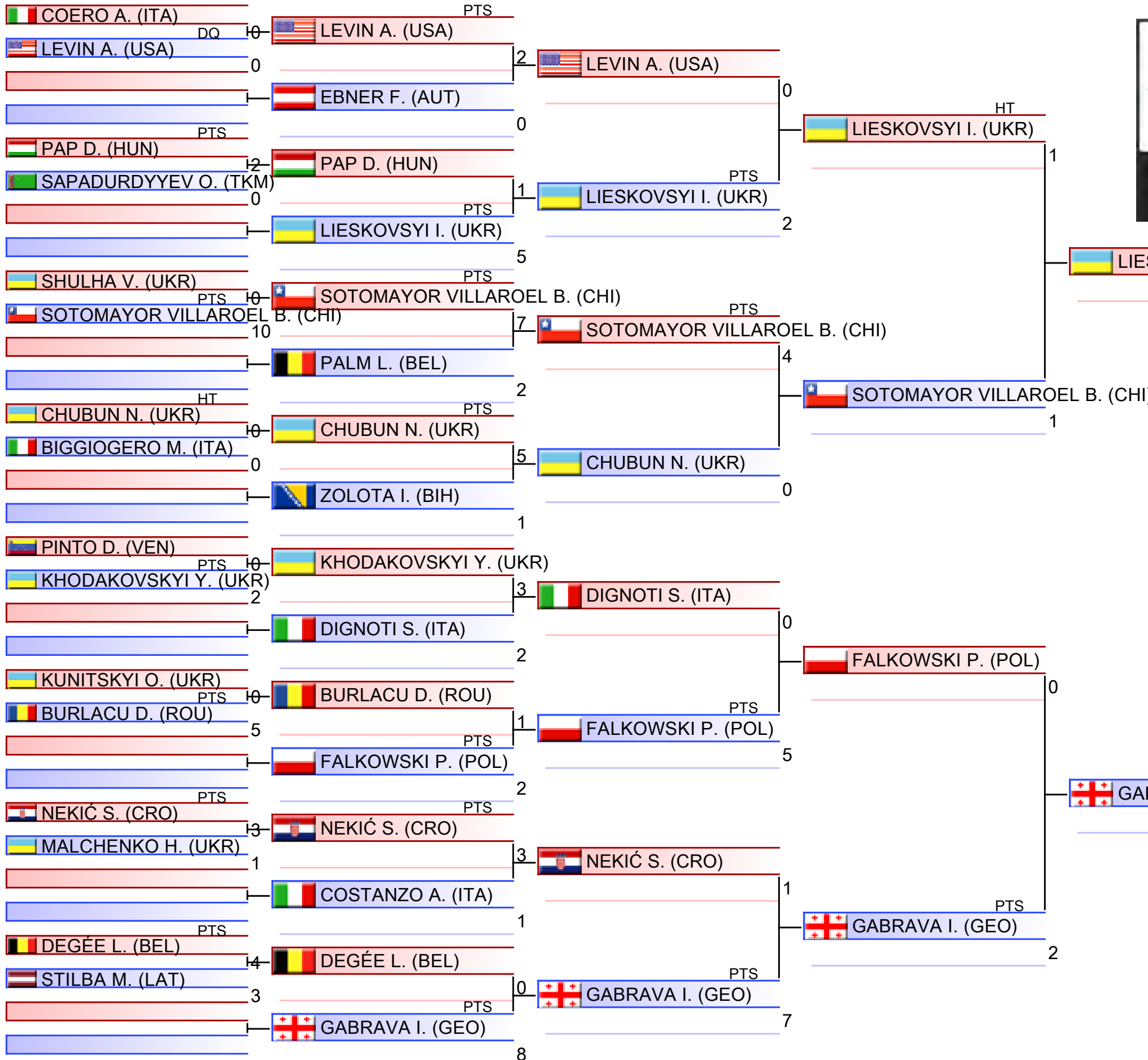

1. DALIPI MEVLAN (KOS)
2. GABRAVA ILIA (GEO)
3. BERGNA LORENZO (ITA)
3. KRASNIQI ANUAR (KOS)
5. LIESKOVSYI ILLIA (UKR)
5. SOMASCHINI FILIPPO (ITA)
7. FALKOWSKI PATRYK (POL)
7. MARIMPOLSKIY BOHDAN (LAT)

U14 Kumite Male -40 kg

Karate1 Youth League - Venice 2024, PALAZZO DEL TURISMO, Piazza Brescia 11, 30016 Lido di Jesolo VE, ITA

2024-12-08

Tatami
2 12:15

Pool
2/4

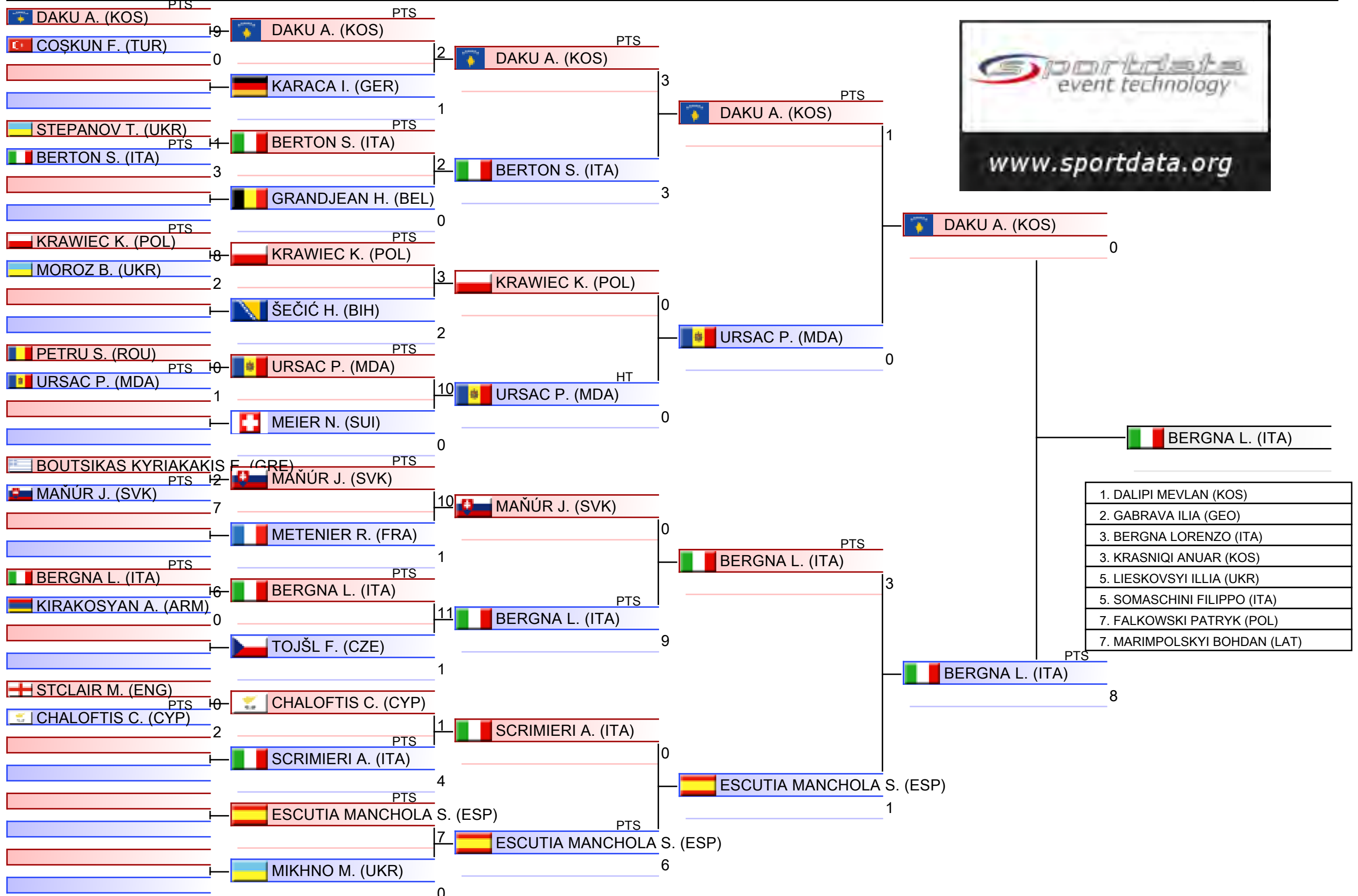

1. DALIPI MEVLAN (KOS)
2. GABRAVA ILIA (GEO)
3. BERGNA LORENZO (ITA)
3. KRASNIQI ANUAR (KOS)
5. LIESKOVSYI ILLIA (UKR)
5. SOMASCHINI FILIPPO (ITA)
7. FALKOWSKI PATRYK (POL)
7. MARIMPOLSKYI BOHDAN (LAT)

U14 Kumite Male -40 kg

Karate1 Youth League - Venice 2024, PALAZZO DEL TURISMO, Piazza Brescia 11, 30016 Lido di Jesolo VE, ITA

2024-12-08

Tatami
3 12:15

Pool
3/4

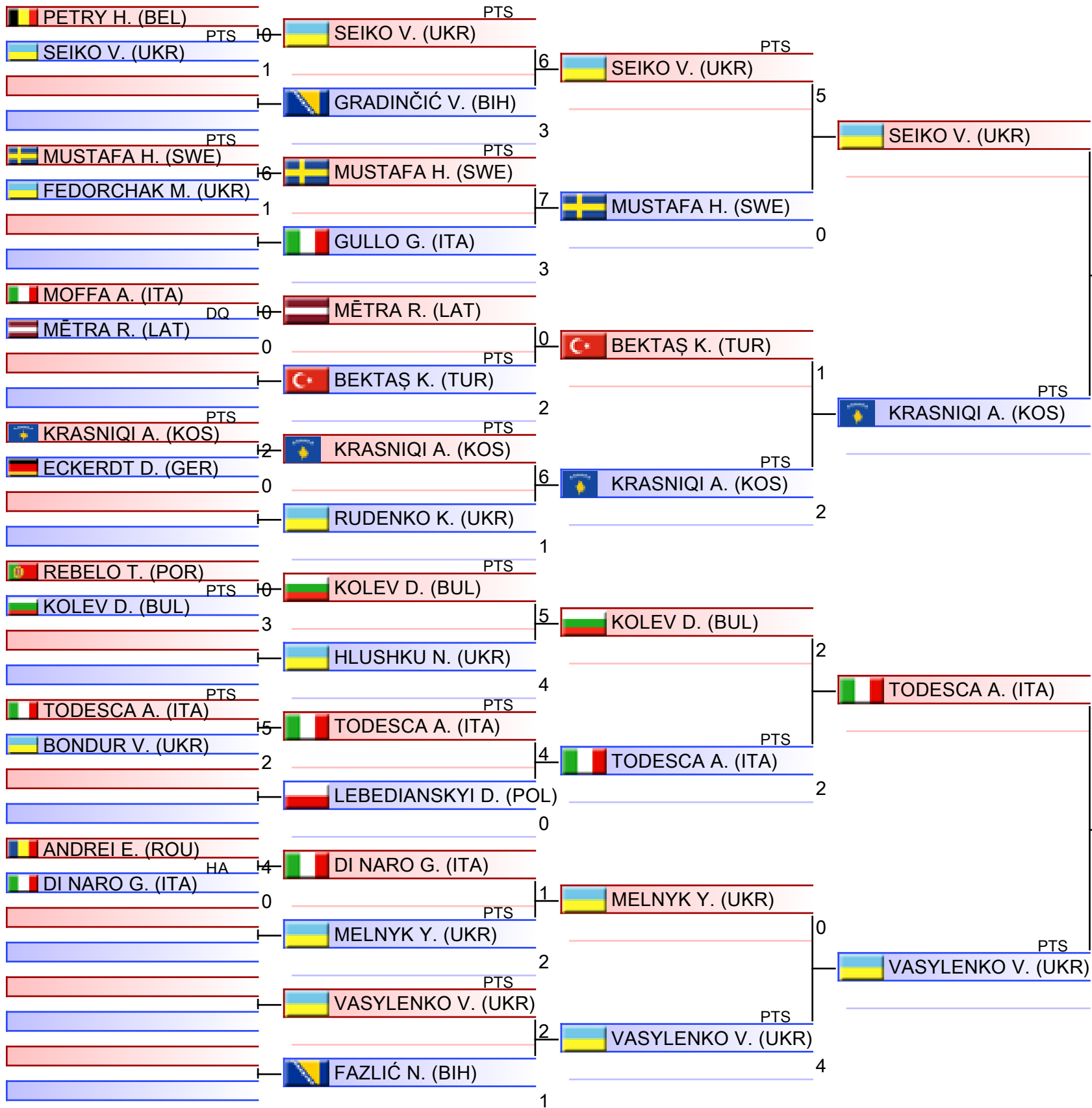

1. DALIPI MEVLAN (KOS)
2. GABRAVA ILIA (GEO)
3. BERGNA LORENZO (ITA)
3. KRASNIQI ANUAR (KOS)
5. LIESKOVSYI ILLIA (UKR)
5. SOMASCHINI FILIPPO (ITA)
7. FALKOWSKI PATRYK (POL)
7. MARIMPOLSKYI BOHDAN (LAT)

U14 Kumite Male -40 kg

Karate1 Youth League - Venice 2024, PALAZZO DEL TURISMO, Piazza Brescia 11, 30016 Lido di Jesolo VE, ITA

2024-12-08

Tatami
4 12:15

Pool
4/4

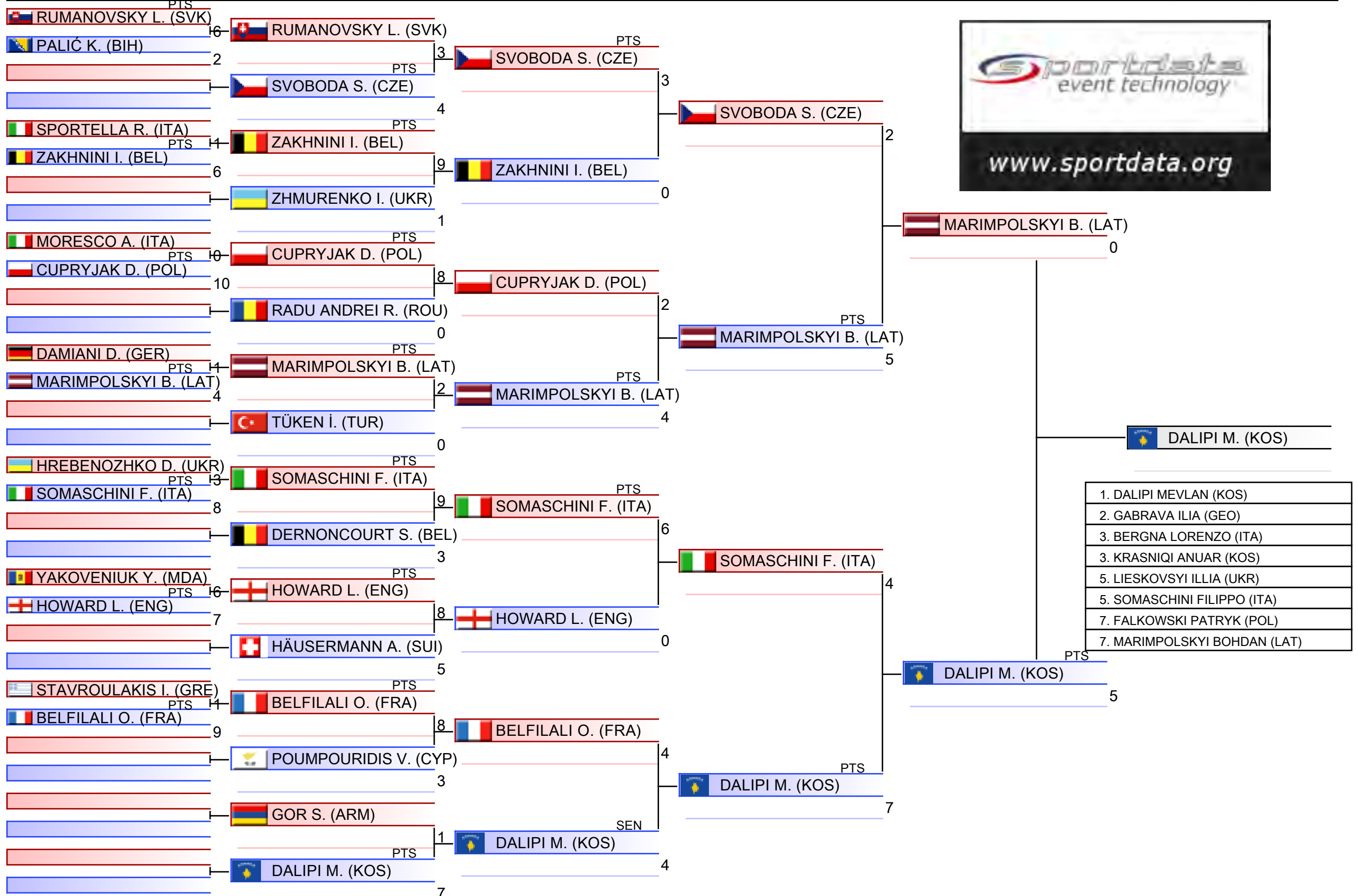

- | |
|------------------------------|
| 1. DALIPI MEVLAN (KOS) |
| 2. GABRAVA ILIA (GEO) |
| 3. BERGNA LORENZO (ITA) |
| 3. KRASNIQI ANUAR (KOS) |
| 5. LIESKOVSYI ILLIA (UKR) |
| 5. SOMASCHINI FILIPPO (ITA) |
| 7. FALKOWSKI PATRYK (POL) |
| 7. MARIMPOLSKYI BOHDAN (LAT) |

Pool winner-U14 Kumite Male -40 kg

Karate1 Youth League - Venice 2024, PALAZZO DEL TURISMO, Piazza Brescia 11, 30016 Lido di Jesolo VE, ITA

2024-12-08

Tatami
3 13:55

Pool
1/1

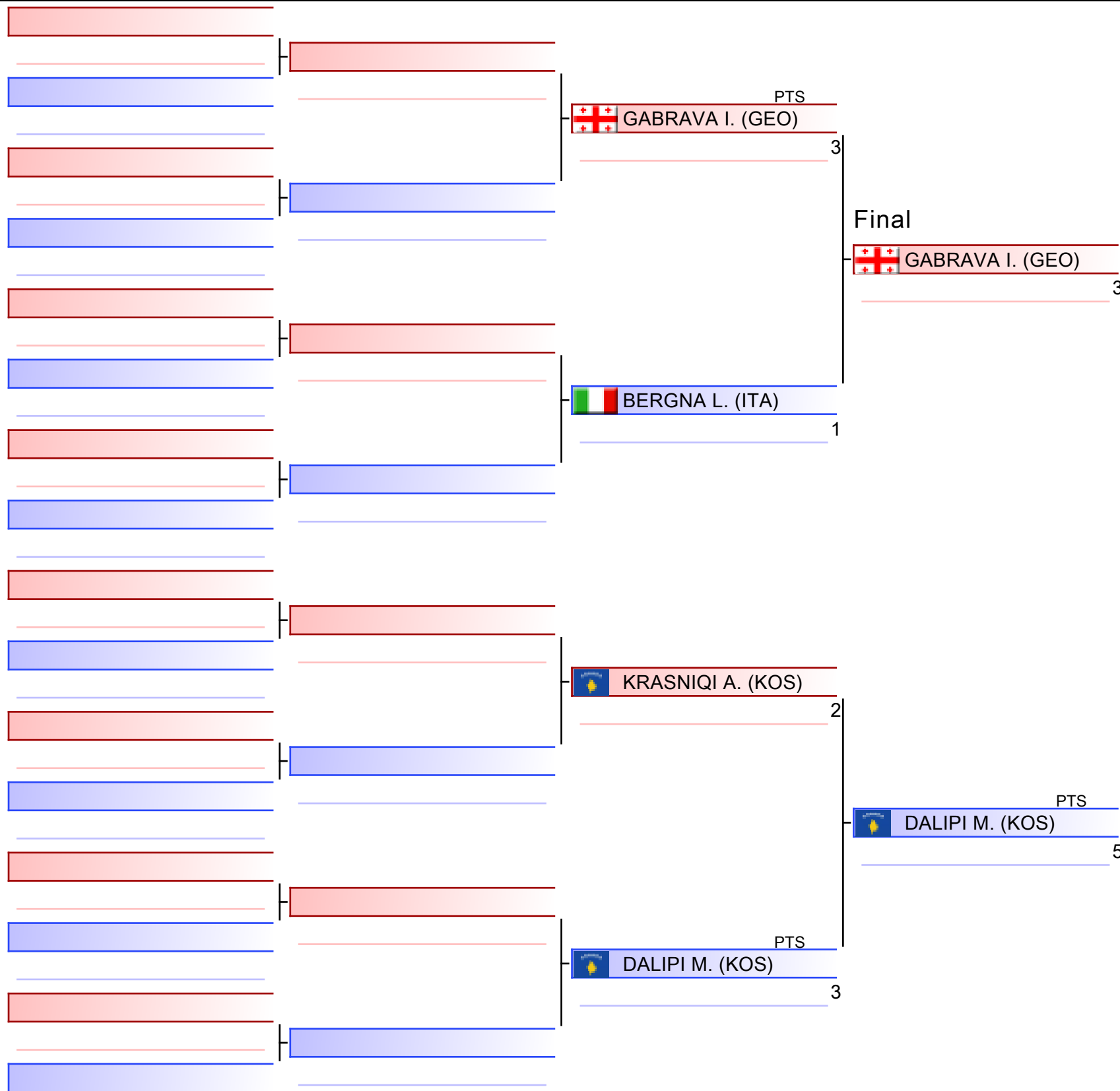

DALIPI M. (KOS)

1. DALIPI MEVLAN (KOS)
2. GABRAVA ILIA (GEO)
3. BERGNA LORENZO (ITA)
3. KRASNIQI ANUAR (KOS)
5. LIESKOVSYI ILLIA (UKR)
5. SOMASCHINI FILIPPO (ITA)
7. FALKOWSKI PATRYK (POL)
7. MARIMPOLSKYI BOHDAN (LAT)

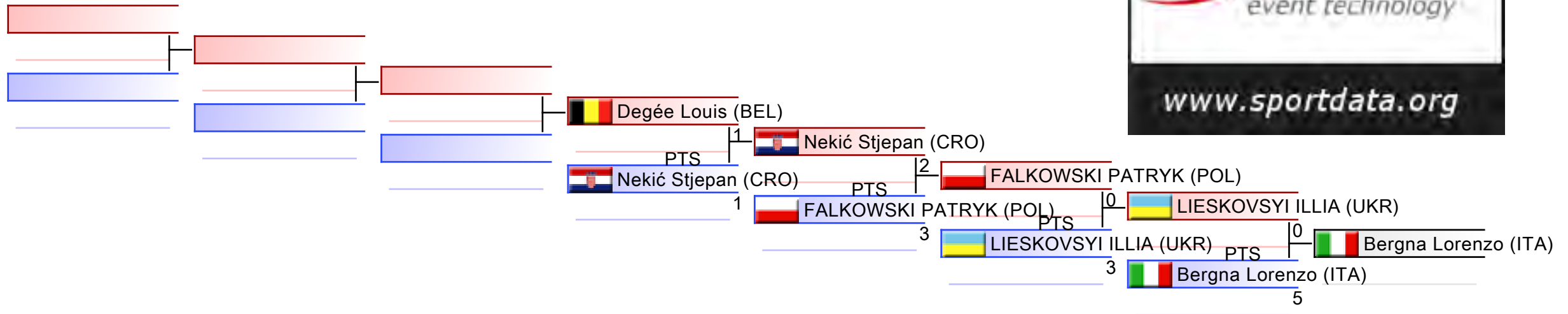

REPECHAGE: (4,2,1,3)

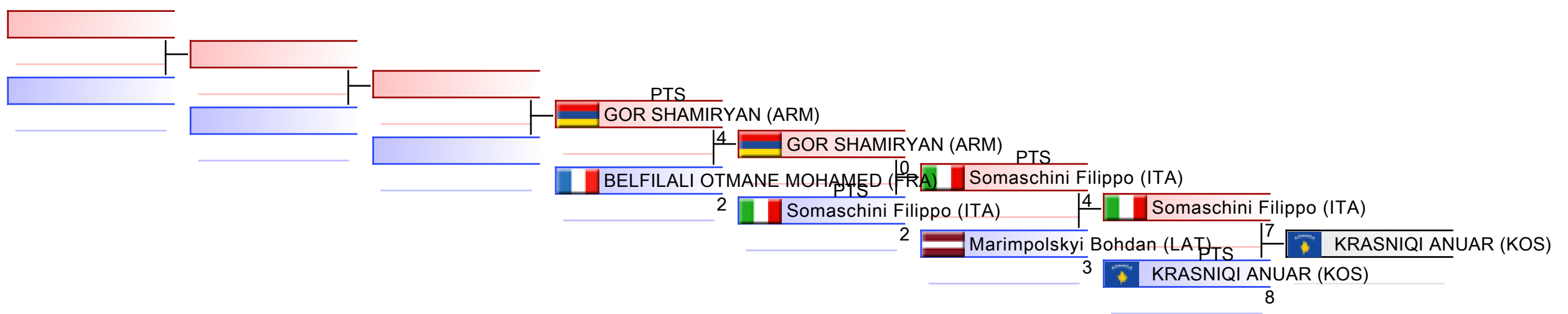



Karate1 Youth League - Venice 2024 - 2024-12-04



Official Results

U14 Kumite Male -40 kg (Entries: 93 Nations: 31)			
1	DALIPI MEVLAN		KOS - KOSOVO
2	GABRAVA ILIA		GEO - GEORGIA
3	BERGNA LORENZO		ITA - ITALY
3	KRASNIQI ANUAR		KOS - KOSOVO
5	LIESKOVSYI ILLIA		UKR - UKRAINE
5	SOMASCHINI FILIPPO		ITA - ITALY
7	FALKOWSKI PATRYK		POL - POLAND
7	MARIMPOLSKYI BOHDAN		LAT - LATVIA
9	NEKIĆ STJEPAN		CRO - CROATIA
9	GOR SHAMIRYAN		ARM - ARMENIA
11	DEGÉE LOUIS		BEL - BELGIUM
11	BELFILALI OTMANE MOHAMED		FRA - FRANCE

U14 KUMITE MALE -45 KG



Karate1 Youth League - Venice 2024

ENTRIES BY WEIGHT CATEGORY



U14 Kumite Male -45 kg

As of 8 DEC 2024

Country Code	ID	Gender	Name	Seeding
AUT		M	BLAGA ALEXANDRU	
AZE	AZE03311	M	SALIMLI ELMADDIN	
BEL		M	Es-Salehy Ismail	
BEL		M	Ghazouani Adam	
BEL		M	Van Den Nieuwenhuijzen Vince	
BIH		M	Muhović Davud	
BUL		M	Georgiev Radoslav	
BUL		M	Stefanov Aleksandar	
CAN	CAN003939	M	PALANISAMY ARUN ADIT	
CRO		M	Brozović Arian	
CRO		M	Kurti Niko	
CRO		M	Pinjuh Bruno	
CZE	CZE003002	M	DOUBEK JACHYM	
CZE		M	Hoffmann Filip	
CZE	CZE002930	M	KOUPAL MARTIN	
CZE		M	Sladký Alexej	
ENG		M	Chandler Keelen John	
ENG	SD76794	M	Pearce George	
ESP		M	Apellaniz Unai	
ESP		M	PEREZ MATA DANIEL	
FRA		M	LE CHEVILLER Gaspard	
GER		M	Dahm Aurelius	
GER		M	Grillinger Jonah	
GER		M	Krause Johannes	
GER		M	Pieper Maximilian	
GRE	GRE003927	M	NTINTEMPASVILI DAVID	
HUN		M	Peres Makszim	
ITA		M	AGOSTINELLI ALESSANDRO	
ITA		M	ALLEGRI MATTEO	
ITA		M	Besutti Luca	
ITA		M	Bon Edoardo	
ITA		M	Bozzi EMANUELE	
ITA	SD66419	M	CAFISO EDOARDO	
ITA		M	CALDARESE GENNARO	
ITA		M	Careglio Niccolò	
ITA		M	Casanova Francesco Pio	
ITA		M	Cortese Erik	
ITA		M	Debenedetti ANDREA	
ITA		M	Del Moro Diego	
ITA		M	Durante Christian Ugo	
ITA		M	Guglielmino Riccardo	
ITA		M	Luciani Federico	
ITA		M	megale antonino	
ITA		M	Nieddu Jacopo	
ITA		M	PRAVATO ALESSANDRO	



Karate1 Youth League - Venice 2024

ENTRIES BY WEIGHT CATEGORY



U14 Kumite Male -45 kg

As of 8 DEC 2024

Country Code	ID	Gender	Name	Seeding
ITA		M	RAGONE MATTIA	
ITA		M	SAPONARO GABRIELE	
ITA		M	STARACE ANDREA	
ITA		M	Talarico Maurizio	
ITA		M	TREVISAN MATTIA	
ITA		M	VARRICCHIO LUCA	
KOS	KOS03322	M	ILIJAZI XHAN	
MDA	MDA002526	M	BOGOMAZ MAXIM	
MDA	MDA002532	M	STANU STANISLAV	
MDA	MDA002539	M	TAMPEI VLADISLAV	
MDA	MDA02379	M	VOLEANSCHI ARSENII	
POL	POL06805	M	BARTNICKI KORNEL	
POL	POL07212	M	KACZMAREK HUBERT	
POL	POL10316	M	Ostrowski Mateusz	
POL	POL05661	M	PUDZIANOWSKI MICHAL	
POL	POL06814	M	SCIBISZ ANTONI	
POL	POL06139	M	ZALESKI ANTONI	
POR		M	Saraiva Martim	
ROU	ROU03240	M	ALIXANDROIU SEBASTIAN	
ROU	ROU03230	M	BAHNARU DAVID	
SCO		M	Wood Lewis	
SLO	SLO02842	M	MILEV MATEJ	
SLO		M	TRAMŠEK ALEKS	
SRB		M	Petrović Petar	
SRB		M	Stojković Petar	
SVK		M	Černo Tomas	
SVK		M	Figa Martin	
SVK		M	Holub Jan Peter	
SWE		M	Durling Charlie	
SWE		M	Mahmic Elvin	
UKR		M	Davyd Hasanov	
UKR		M	Dorosh Mark	
UKR		M	Drahun Rodion	
UKR		M	Ivankov Oleh	
UKR		M	Krylovskiy Yurii	
UKR		M	Manzaruk Arystarkh	
UKR		M	Matveiev Artur	
UKR		M	MOLCHANOV NIKITA	
UKR		M	Odynets Oleksandr	
UKR		M	Rudniev Kyril	
UKR		M	SEMENCHENKO DENYS	
UKR		M	Shchemelov Tymofii	
UKR		M	Verbitskyi Filip	

U14 Kumite Male -45 kg

Karate1 Youth League - Venice 2024, PALAZZO DEL TURISMO, Piazza Brescia 11, 30016 Lido di Jesolo VE, ITA

2024-12-08

Tatami
5 13:15

Pool
1/4

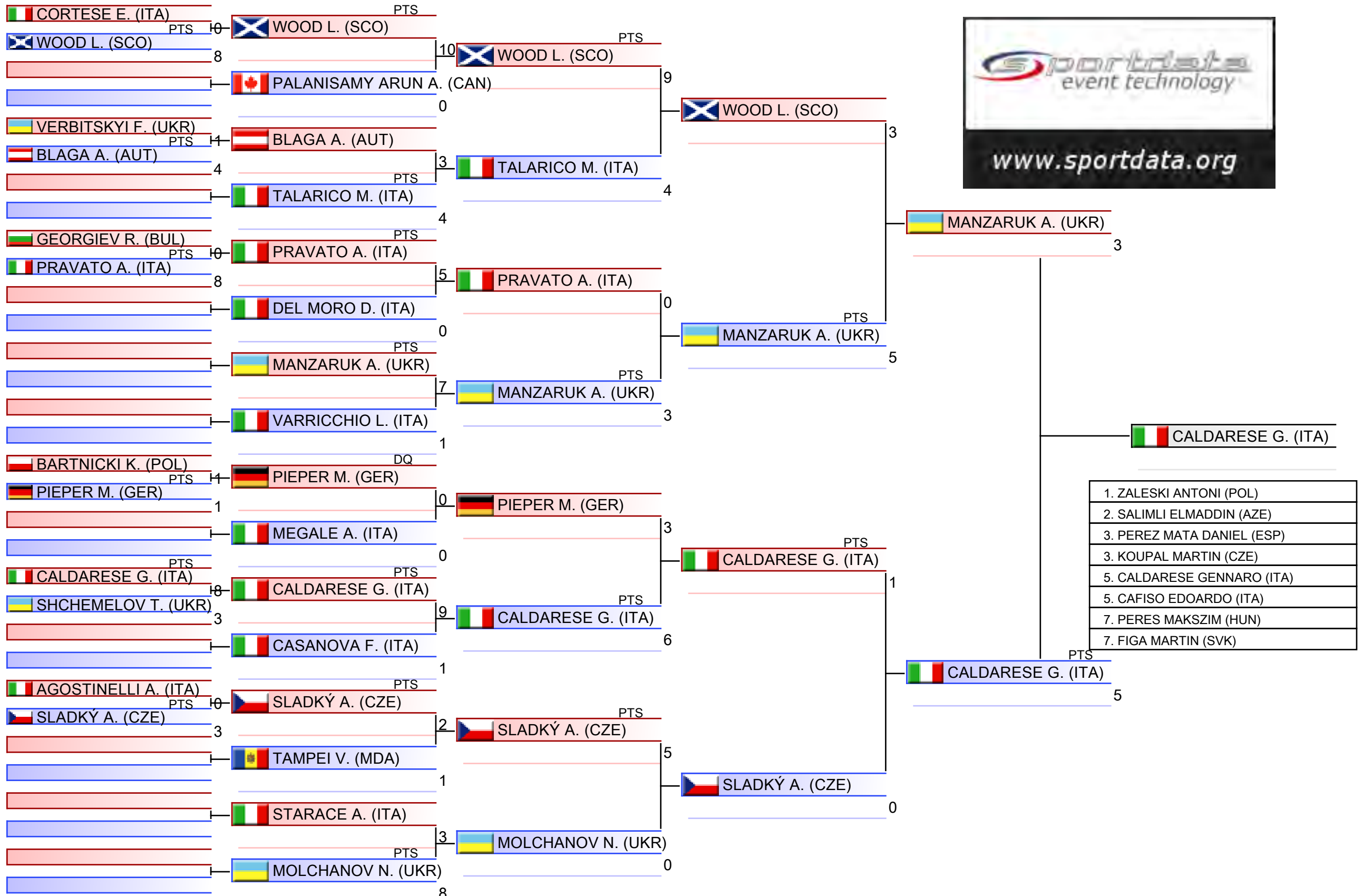

U14 Kumite Male -45 kg

Karate1 Youth League - Venice 2024, PALAZZO DEL TURISMO, Piazza Brescia 11, 30016 Lido di Jesolo VE, ITA

2024-12-08

Tatami
6 13:15

Pool
2/4

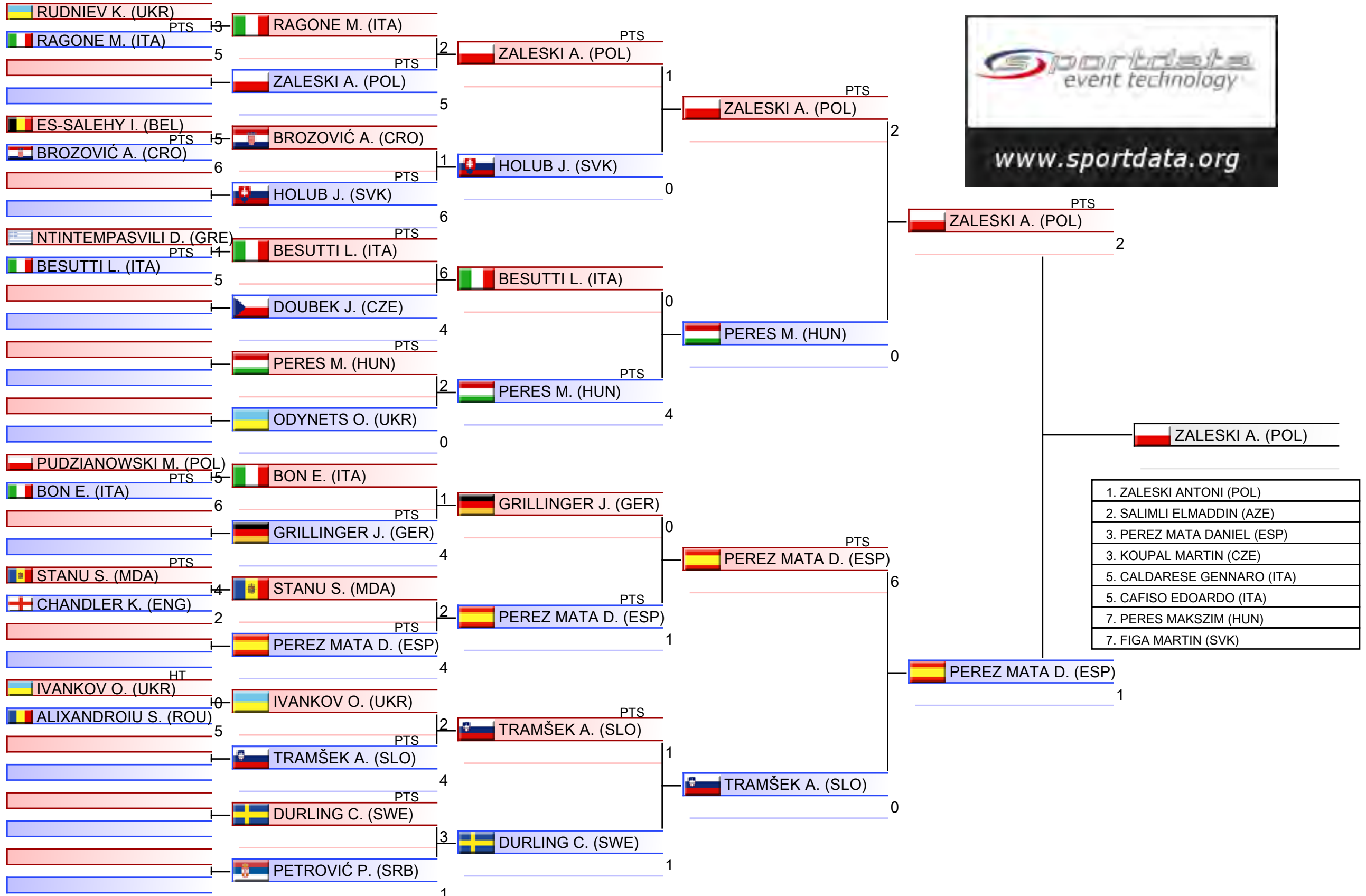

1. ZALESKI ANTONI (POL)
2. SALIMLI ELMADDIN (AZE)
3. PEREZ MATA DANIEL (ESP)
3. KOUPAL MARTIN (CZE)
5. CALDARESE GENNARO (ITA)
5. CAFISO EDOARDO (ITA)
7. PERES MAKSZIM (HUN)
7. FIGA MARTIN (SVK)

U14 Kumite Male -45 kg

Karate1 Youth League - Venice 2024, PALAZZO DEL TURISMO, Piazza Brescia 11, 30016 Lido di Jesolo VE, ITA

2024-12-08

Tatami
7 13:15

Pool
3/4

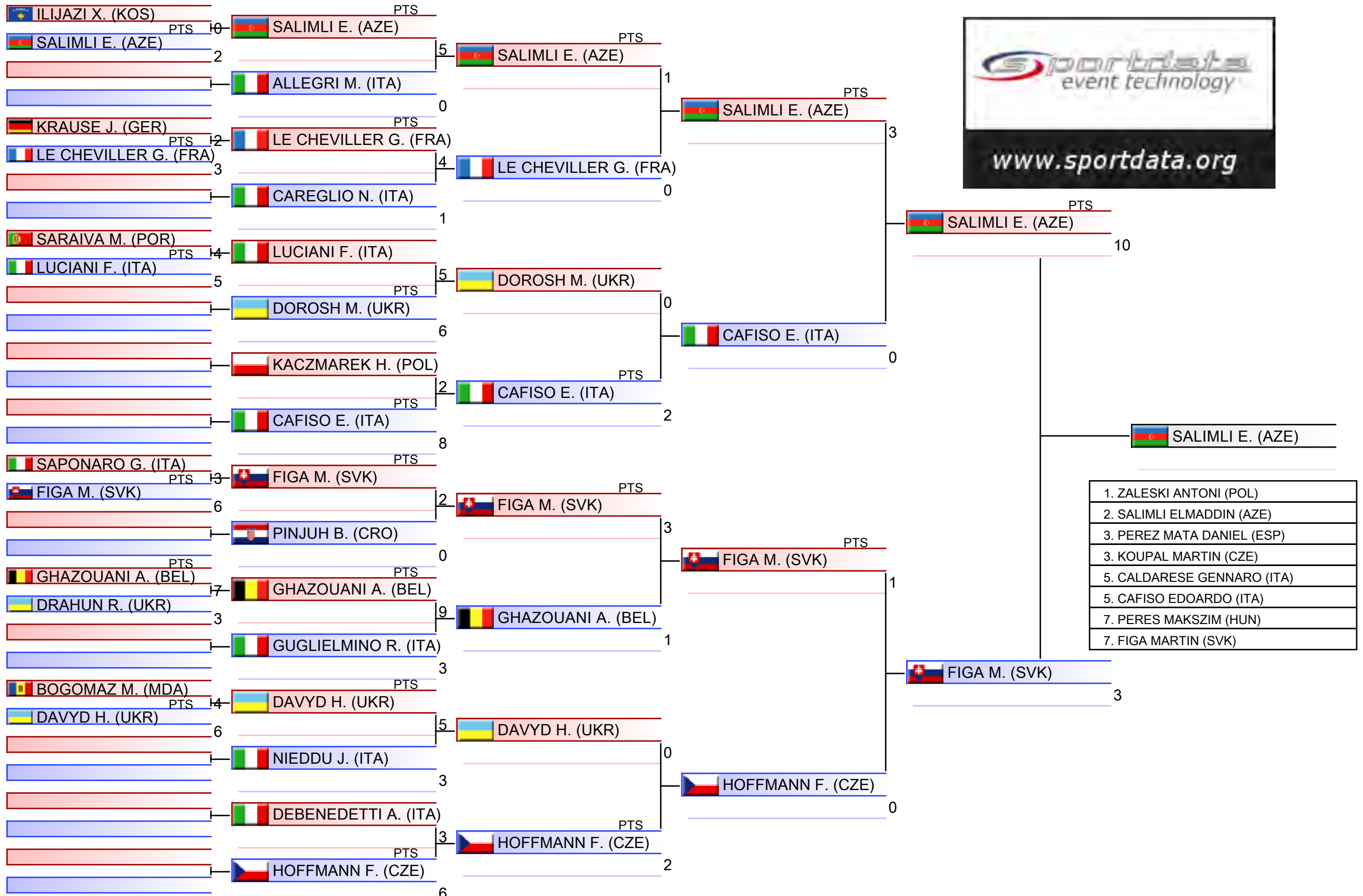

U14 Kumite Male -45 kg

Karate1 Youth League - Venice 2024, PALAZZO DEL TURISMO, Piazza Brescia 11, 30016 Lido di Jesolo VE, ITA

2024-12-08

Tatami
8 13:10

Pool
4/4

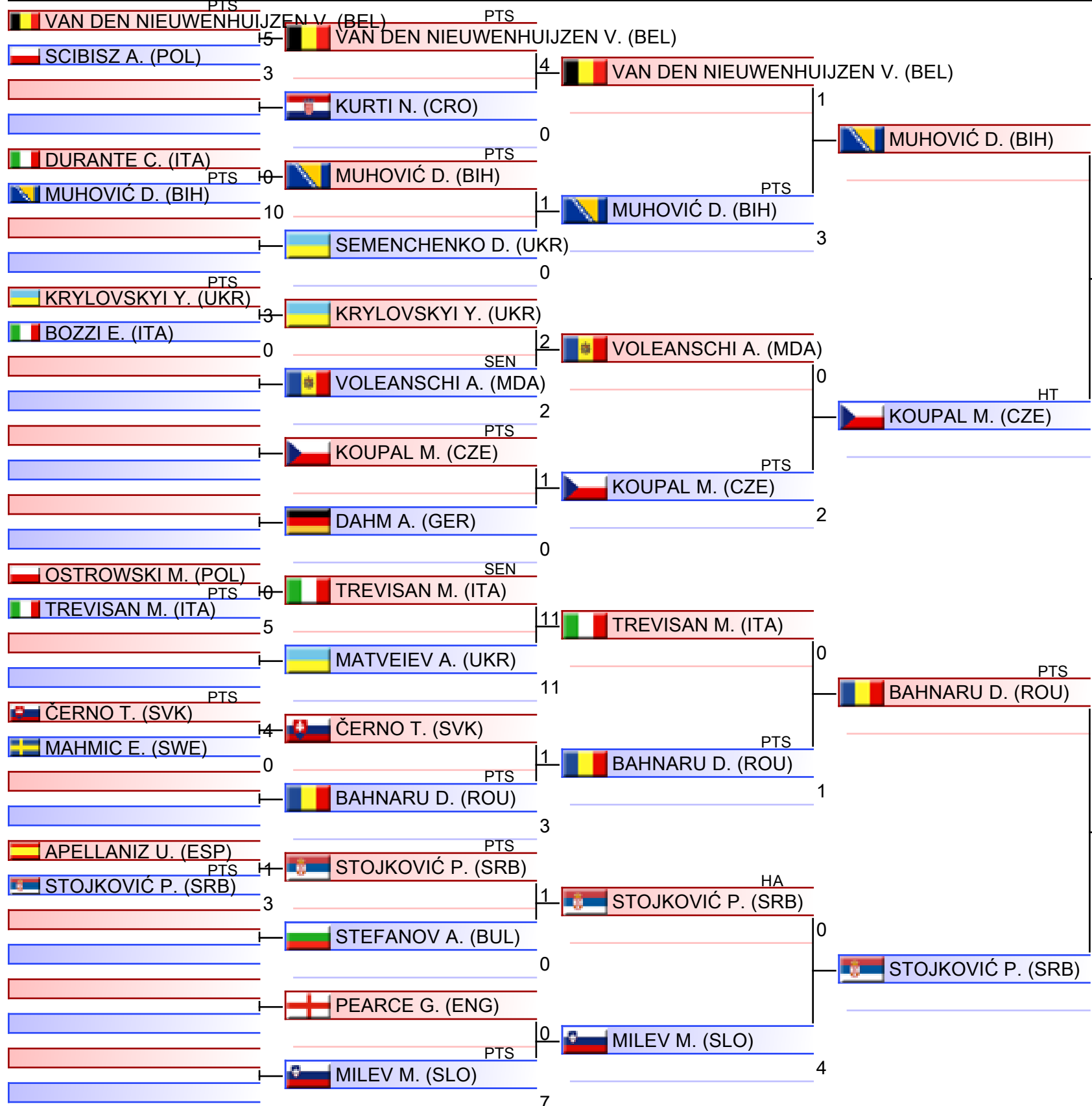

1. ZALESKI ANTONI (POL)
2. SALIMLI ELMADDIN (AZE)
3. PEREZ MATA DANIEL (ESP)
3. KOUPAL MARTIN (CZE)
5. CALDARESE GENNARO (ITA)
5. CAFISO EDOARDO (ITA)
7. PERES MAKSZIM (HUN)
7. FIGA MARTIN (SVK)

Pool winner-U14 Kumite Male -45 kg

Karate1 Youth League - Venice 2024, PALAZZO DEL TURISMO, Piazza Brescia 11, 30016 Lido di Jesolo VE, ITA

2024-12-08

Tatami

5 14:50

Pool

1/1

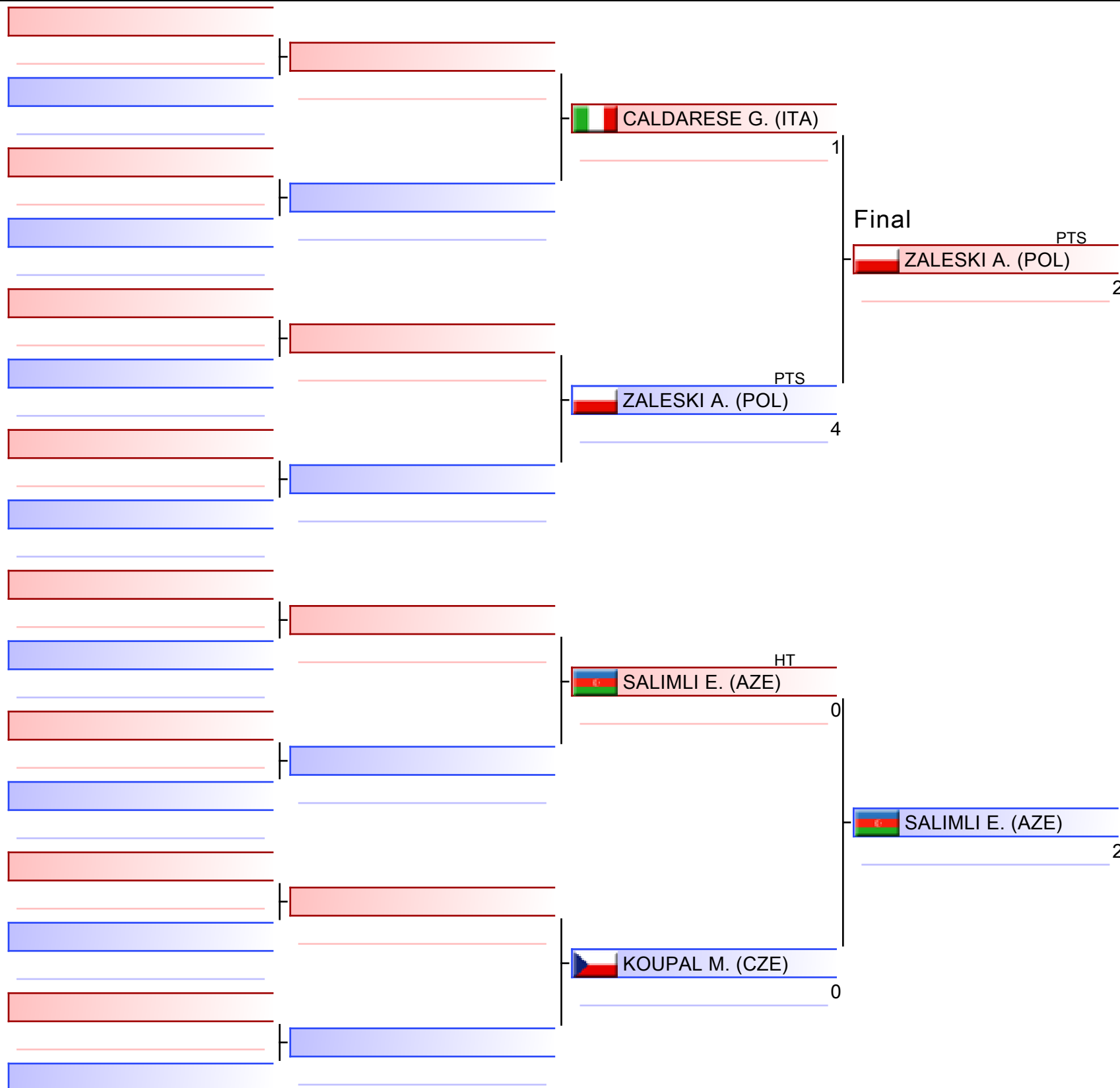

ZALESKI A. (POL)

1. ZALESKI ANTONI (POL)
2. SALIMLI ELMADDIN (AZE)
3. PEREZ MATA DANIEL (ESP)
3. KOUPAL MARTIN (CZE)
5. CALDARESE GENNARO (ITA)
5. CAFISO EDOARDO (ITA)
7. PERES MAKSZIM (HUN)
7. FIGA MARTIN (SVK)

U14 Kumite Male -45 kg

Karate1 Youth League - Venice 2024

2024-12-08

Tatami
3 15:45

Pool
1,2,3,4

(c)sportdata GmbH & Co KG 2000-2024 (2024-12-08 20:16) v 10.2.0 build 1 (2024-11-20 00:58 CET) License: SDIL TVG (expire 2025-01-26)

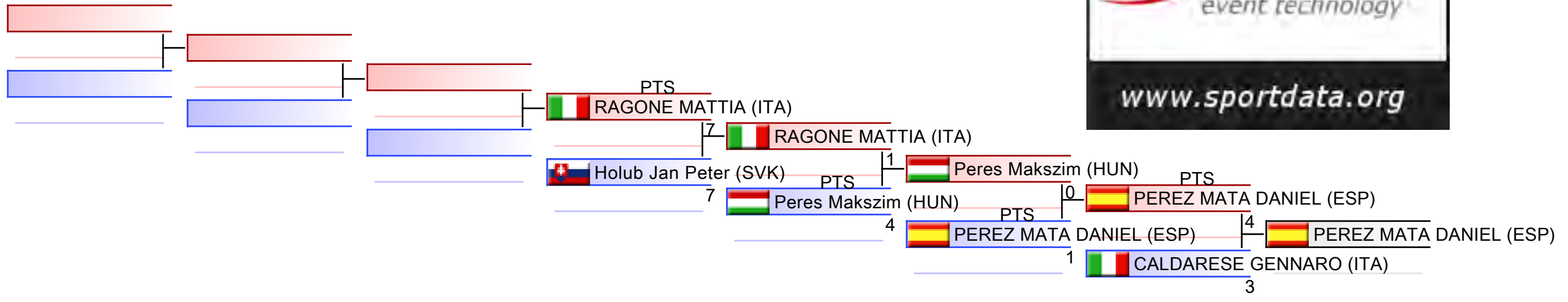

REPECHAGE: (1,2,3,4)

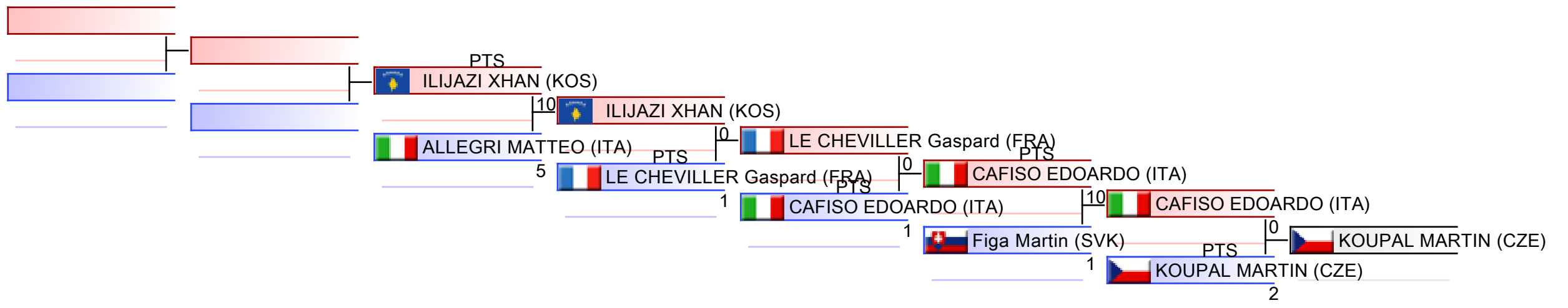



Karate1 Youth League - Venice 2024 - 2024-12-04



Official Results

U14 Kumite Male -45 kg (Entries: 88 Nations: 26)			
1	ZALESKI ANTONI		POL - POLAND
2	SALIMLI ELMADDIN		AZE - AZERBAIJAN
3	PEREZ MATA DANIEL		ESP - SPAIN
3	KOUPAL MARTIN		CZE - CZECH REPUBLIC
5	CALDARESE GENNARO		ITA - ITALY
5	CAFISO EDOARDO		ITA - ITALY
7	PERES MAKSZIM		HUN - HUNGARY
7	FIGA MARTIN		SVK - SLOVAKIA
9	RAGONE MATTIA		ITA - ITALY
9	LE CHEVILLER GASPARD		FRA - FRANCE
11	HOLUB JAN PETER		SVK - SLOVAKIA
11	ILIJAZI KHAN		KOS - KOSOVO
13	ALLEGRI MATTEO		ITA - ITALY

U14 KUMITE MALE -50 KG



Karate1 Youth League - Venice 2024

ENTRIES BY WEIGHT CATEGORY



U14 Kumite Male -50 kg

As of 8 DEC 2024

Country Code	ID	Gender	Name	Seeding
ARM		M	Danielyan Edmond	
AUT	AUT003121	M	Schnetzer Eric	
BIH		M	Tadić Miloš	
BRA		M	Tsoy Victor	
BUL		M	MARKOV GEORGI	
BUL		M	Nikolov Nikola	
BUL		M	Stefanov Aleksandar	
BUL		M	Stoyanov Andrey	
CRO		M	Delić Toni	
CRO		M	Karačić Ivan	
CRO		M	Laginja Ivan	
CZE		M	Tetour Jan	
ENG		M	Gauci Charlie	
ESP		M	Olmos David	
GEO	GEO002910	M	ZAKARAIA GIORGI	
GER		M	Braunroth Florian	
GER		M	Linke Florian	
GER		M	Ruhmann Benjamin	
GER		M	von Treschkow Nepomuk	
GRE	GRE02961	M	ANGELIS GEORGIOS	
GRE	GRE003946	M	CHARALAMPIDIS NIKOLAOS TAXIARCHIS	
GRE		M	TSAGARAKIS MILTIADIS	
HUN		M	Bagi Ádám	
HUN		M	Hercz Bence	
HUN		M	Kürk Zétény	
ITA		M	Baldassarre Samuel Vincenzo	
ITA		M	Basoni Francesco Pio	
ITA		M	COMENDULLI LEONARDO	
ITA		M	DEL GRECO JACOPO	
ITA		M	DE PETRIS ALESSIO	
ITA		M	DIDONI LORENZO	
ITA		M	FRATTINA ANDREA DARIO	
ITA		M	GENOCCHIO ALEX	
ITA		M	Lambro Luigi	
ITA		M	LIOI ANDREA	
ITA		M	MAGNELLI LEONARDO	
ITA		M	Marrucci Filippo	
ITA		M	NOBILE SIMONE	
ITA		M	PAGLIONICO VITTORIO	
ITA		M	PEZZOTTI FRANCESCO	
ITA		M	PINCIO NICHOLAS	
ITA		M	Pontil Scala Lorenzo	
ITA		M	Rossi Francesco Alberto	
ITA		M	Scanacapra Leonardo	
ITA		M	TASSAN GURLE MICHELE	



Karate1 Youth League - Venice 2024

ENTRIES BY WEIGHT CATEGORY



U14 Kumite Male -50 kg

As of 8 DEC 2024

Country Code	ID	Gender	Name	Seeding
KOS	KOS03315	M	ADEMI LEART	
KOS	KOS03335	M	MALOKAJ SHKEMB	
KOS	KOS03333	M	MALOKAJ YLLI	
KOS	KOS003629	M	MUHAXHERI ERENİK	
KUW	KUW02901	M	ALOTAIBI ABDULWAHAB	
KUW	KUW003017	M	ALTUWAIJRI BADER	
LAT		M	Kisiks Zahars	
LAT		M	Ozerovs Artjoms	
MDA	MDA02382	M	VOLEANSCHI AKIM	
MNE		M	ALJOŠEVIĆ ARIJAN	
NED	SD81135	M	Enthoven Scott	
POL	POL06709	M	BARANOWSKI DOMINIK	
POL	POL2804	M	BUDNY SZYMON	
POR		M	Garcia António Gonçalo	
POR		M	Oliveira Diogo	
ROU	ROU03605	M	DUMITRU MIRCEA ANDREI	
ROU	ROU03630	M	TUDORACHE STEFAN ALEXANDRU	
SRB		M	Laušević Danilo	
SRB		M	Tasić Nikola	
SUI		M	Iseppi Nevio	
SVK		M	KOVÁČIK Šimon	
SVK		M	Marcinek Maxim	
SVK		M	Meňhert Michal	
TUR		M	AYDIN AHMET SAİT	
TUR		M	Felhan Salih	
TUR		M	OZER EGE	
UKR		M	Avramenko Roman	
UKR		M	BEKESHKO IVAN	
UKR		M	HLUSHKO TYMOFII	
UKR		M	Kurinov Daniil	
UKR		M	MARCHENKO OLEKSII	
UKR		M	MARYSENKO BOHDAN	
UKR		M	MATSENKO IVAN	
UKR		M	Pryima Roman	
UKR		M	RADKOVSKYI ANDRIY	
UKR		M	Sagrunov Oleksandr	
UKR		M	Savytskyi Mykhailo	
UKR		M	TARNAVSKYI MAKSYM	
UKR		M	Tykhovetskyi Artem	
UKR		M	Ustiantsev Mark	
UKR		M	Vedmid Illia	

U14 Kumite Male -50 kg

Karate1 Youth League - Venice 2024, PALAZZO DEL TURISMO, Piazza Brescia 11, 30016 Lido di Jesolo VE, ITA

2024-12-08

Tatami
1 14:05

Pool
1/4

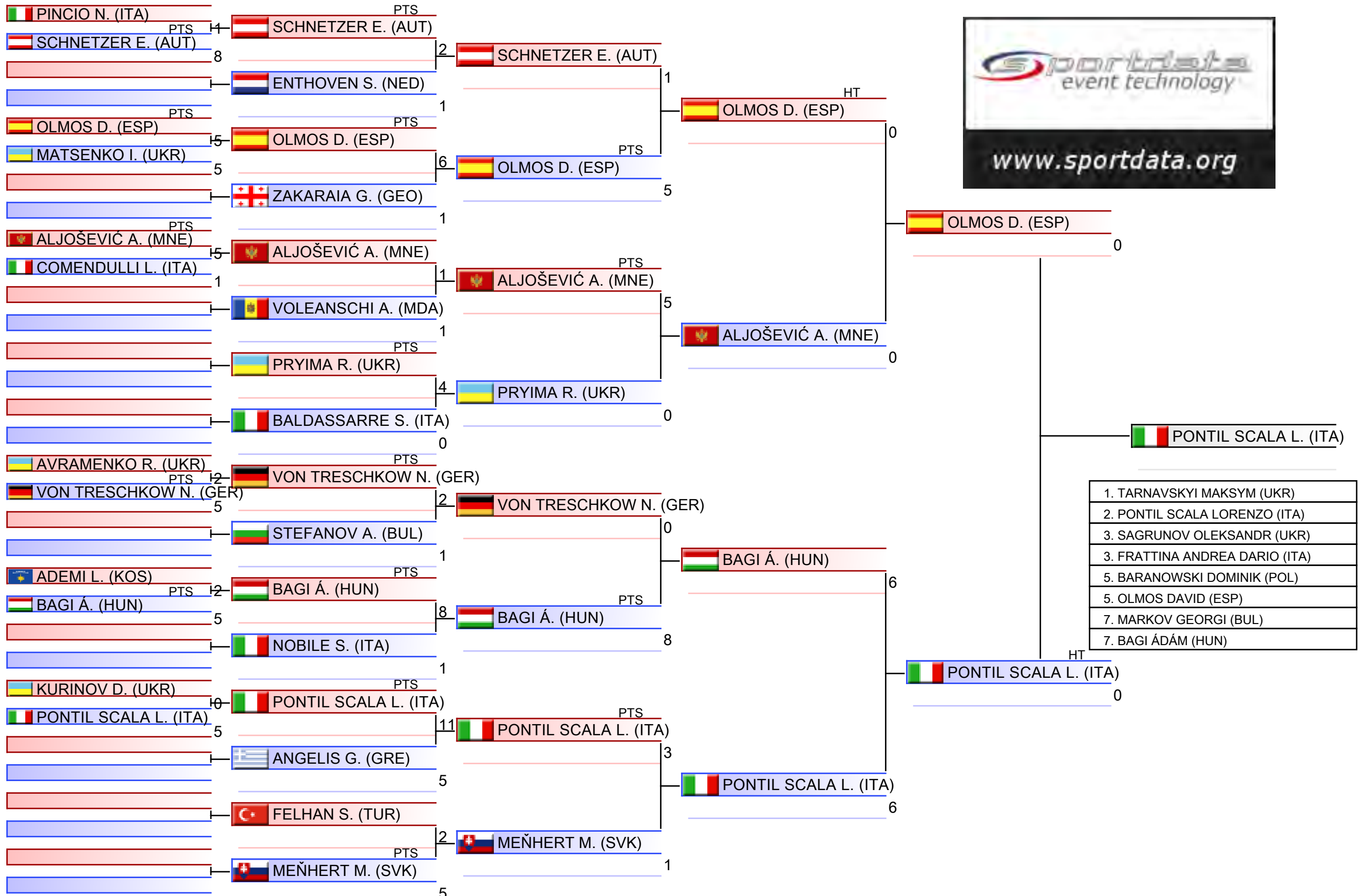

U14 Kumite Male -50 kg

Karate1 Youth League - Venice 2024, PALAZZO DEL TURISMO, Piazza Brescia 11, 30016 Lido di Jesolo VE, ITA

2024-12-08

Tatami
2 14:05

Pool
2/4

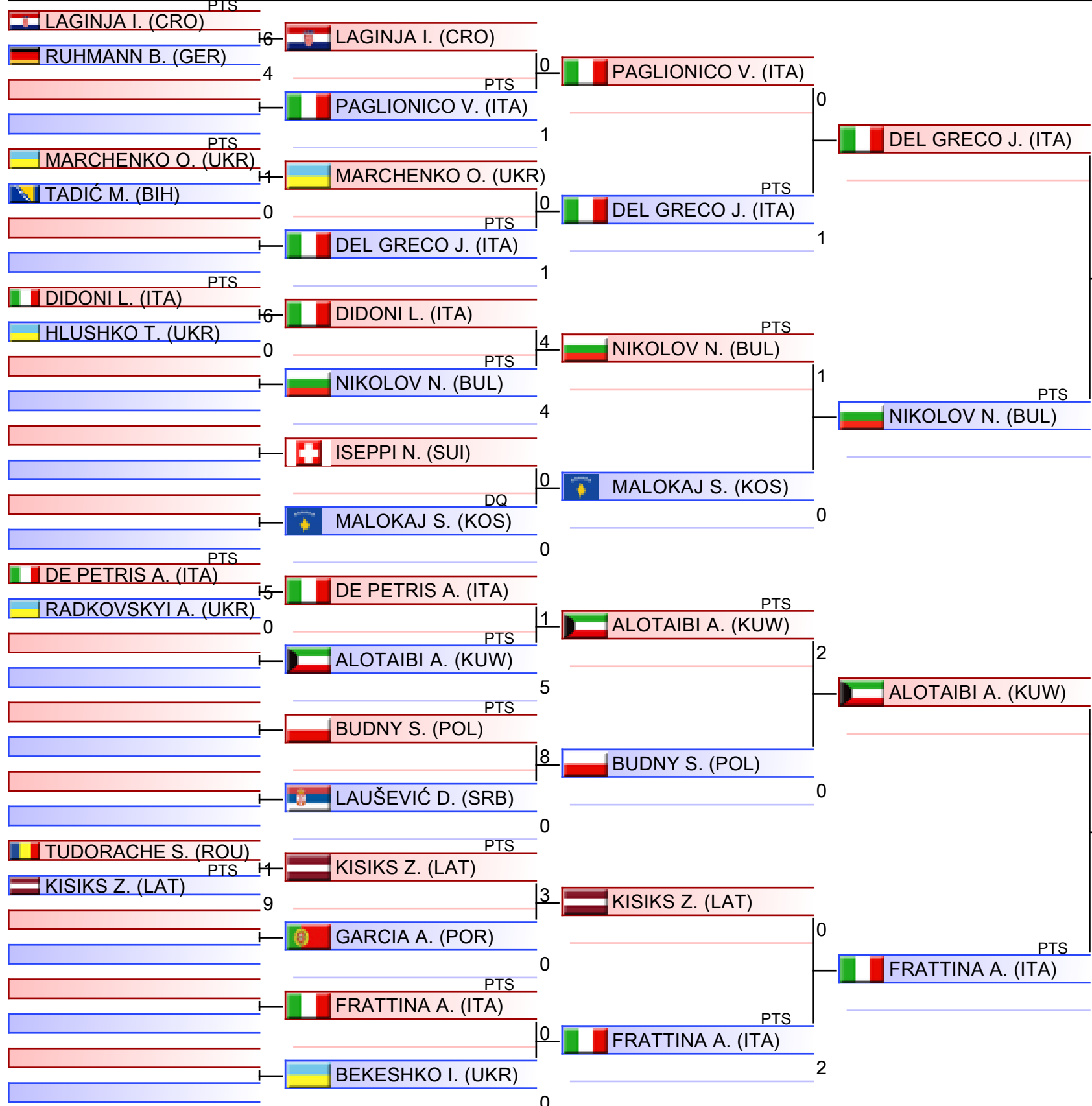

- | |
|--------------------------------|
| 1. TARNAVSKYI MAKSYM (UKR) |
| 2. PONTIL SCALA LORENZO (ITA) |
| 3. SAGRUNOV OLEKSANDR (UKR) |
| 3. FRATTINA ANDREA DARIO (ITA) |
| 5. BARANOWSKI DOMINIK (POL) |
| 5. OLMOS DAVID (ESP) |
| 7. MARKOV GEORGI (BUL) |
| 7. BAGI ÁDÁM (HUN) |

U14 Kumite Male -50 kg

Karate1 Youth League - Venice 2024, PALAZZO DEL TURISMO, Piazza Brescia 11, 30016 Lido di Jesolo VE, ITA

2024-12-08

Tatami
4 14:05

Pool
4/4

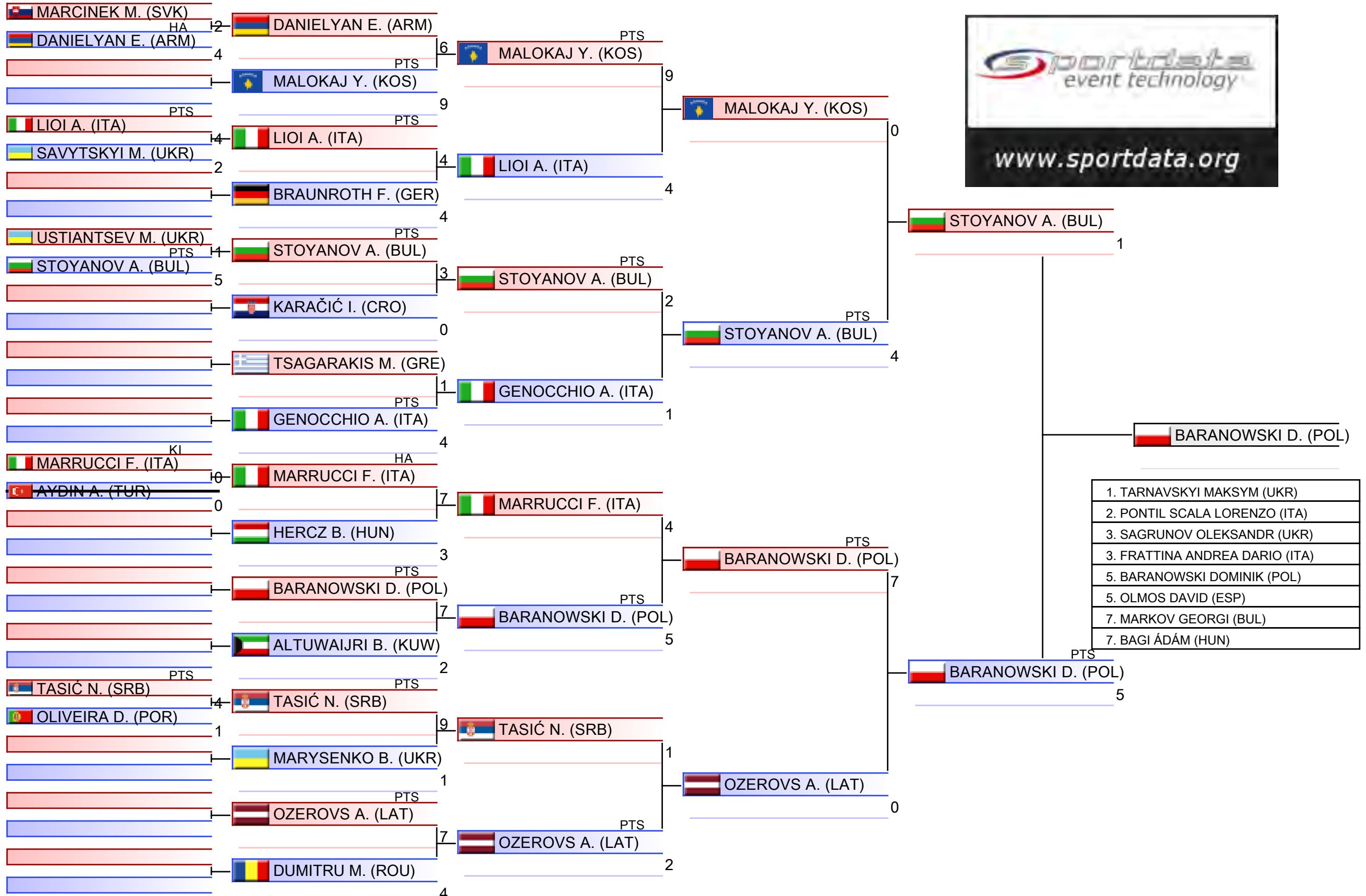

- | | |
|----|-----------------------------|
| 1. | TARNAVSKYI MAKSYM (UKR) |
| 2. | PONTIL SCALA LORENZO (ITA) |
| 3. | SAGRUNOV OLEKSANDR (UKR) |
| 3. | FRATTINA ANDREA DARIO (ITA) |
| 5. | BARANOWSKI DOMINIK (POL) |
| 5. | OLMOS DAVID (ESP) |
| 7. | MARKOV GEORGI (BUL) |
| 7. | BAGI ÁDÁM (HUN) |

Pool winner-U14 Kumite Male -50 kg

Karate1 Youth League - Venice 2024, PALAZZO DEL TURISMO, Piazza Brescia 11, 30016 Lido di Jesolo VE, ITA

2024-12-08

Tatami
1 15:35

Pool
1/1

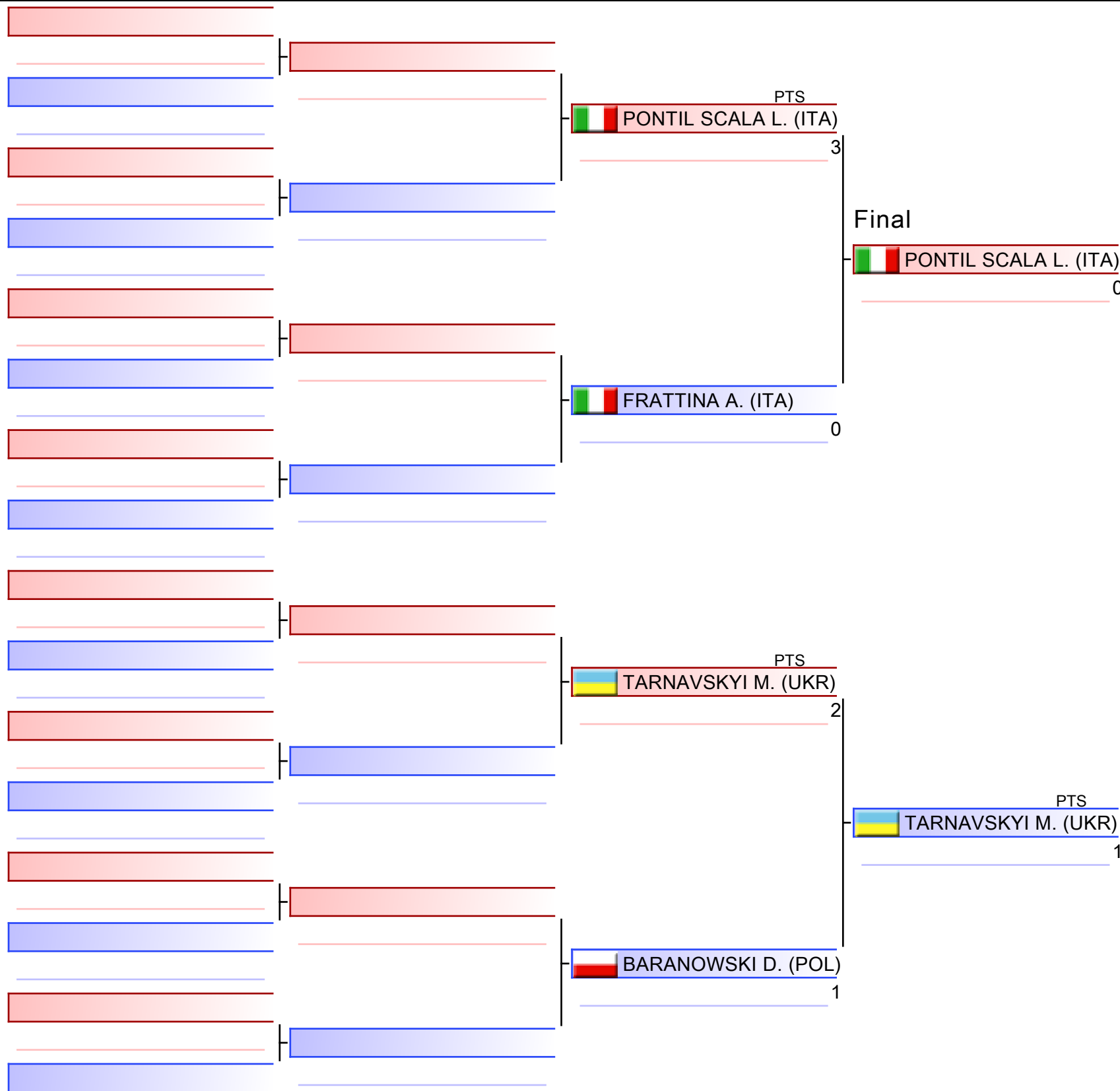

TARNAVSKYI M. (UKR)

1. TARNAVSKYI MAKSYM (UKR)
2. PONTIL SCALA LORENZO (ITA)
3. SAGRUNOV OLEKSANDR (UKR)
3. FRATTINA ANDREA DARIO (ITA)
5. BARANOWSKI DOMINIK (POL)
5. OLMOS DAVID (ESP)
7. MARKOV GEORGI (BUL)
7. BAGI ÁDÁM (HUN)

U14 Kumite Male -50 kg

Karate1 Youth League - Venice 2024

2024-12-08

Tatami
4 15:45

Pool
1,2,3,4

(c)sportdata GmbH & Co KG 2000-2024 (2024-12-08 20:16) v 10.2.0 build 1 (2024-11-20 00:58 CET) License: SDIL TVG (expire 2025-01-26)

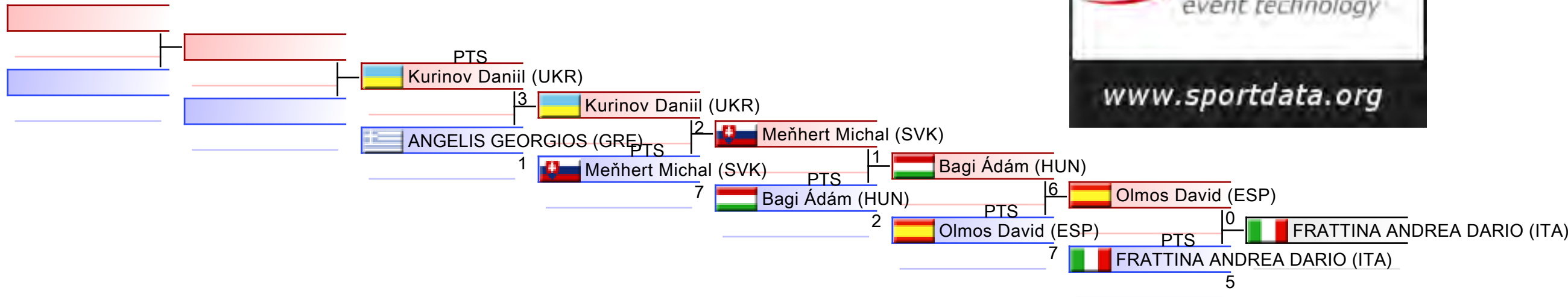

REPECHAGE: (1,2,3,4)

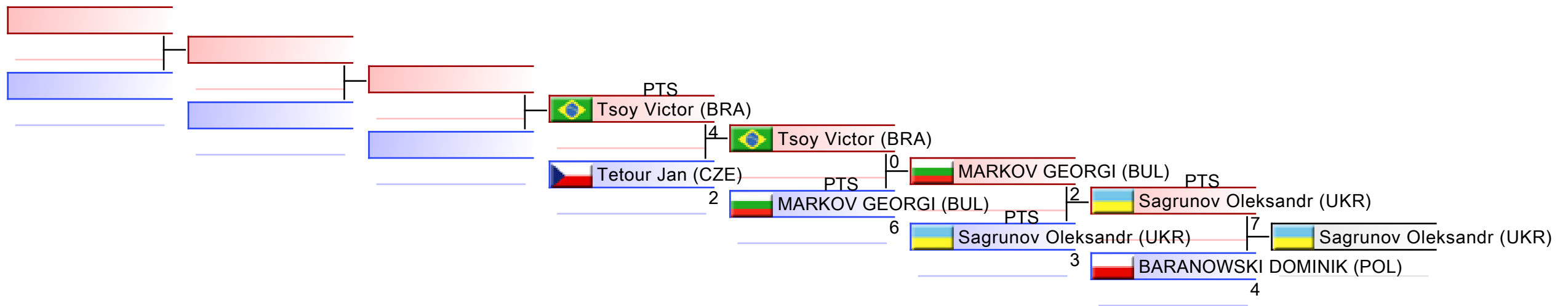



Karate1 Youth League - Venice 2024 - 2024-12-04



Official Results

U14 Kumite Male -50 kg (Entries: 86 Nations: 28)			
1	TARNAVSKYI MAKSYM		UKR - UKRAINE
2	PONTIL SCALA LORENZO		ITA - ITALY
3	SAGRUNOV OLEKSANDR		UKR - UKRAINE
3	FRATTINA ANDREA DARIO		ITA - ITALY
5	BARANOWSKI DOMINIK		POL - POLAND
5	OLMOS DAVID		ESP - SPAIN
7	MARKOV GEORGI		BUL - BULGARIA
7	BAGI ÁDÁM		HUN - HUNGARY
9	TSOY VICTOR		BRA - BRAZIL
9	MENHERT MICHAL		SVK - SLOVAKIA
11	TETOUR JAN		CZE - CZECH REPUBLIC
11	KURINOV DANIIL		UKR - UKRAINE
13	ANGELIS GEORGIOS		GRE - GREECE

U14 KUMITE MALE -55 KG



Karate1 Youth League - Venice 2024

ENTRIES BY WEIGHT CATEGORY



U14 Kumite Male -55 kg

As of 8 DEC 2024

Country Code	ID	Gender	Name	Seeding
AIN-1		M	Grishkin Egor	
ARM	ARM003060	M	SARGSYAN BAGRAT	
AZE	AZE003416	M	AHMADZADA YUSIF	
BEL		M	Mehadhebi Amir	
BIH		M	Gracic Dan	
BIH		M	MiskiĆ Elmin	
BUL		M	Ignatov Samuil	
CAN		M	Ben Tekaya Ahmed	
CRO		M	Dobre Lukas	
CRO		M	Kvesić Viktor	
CYP		M	KIOURTZIDIS DIMITRIS	
CZE		M	Nedbal Vít	
ENG		M	Bowron Jaden	
ENG		M	McNaughton Cameron	
ESP		M	Lopez Milan Mario	
ESP		M	RODRIGUEZ FUENTES ENRIQUE	
FRA		M	le clech malagrida owen	
FRA		M	Nguyen Théodore	
GER		M	Beckmann Max	
GRE	GRE03454	M	ANTONIOU VASILEIOS	
ITA		M	ADOLINI DIEGO	
ITA		M	ANNUNZIATA DAVIDE	
ITA		M	BERGANTINO DAVIDE	
ITA	ITA483230	M	CERSOSIMO ALESSANDRO	
ITA		M	Conversini Simone	
ITA		M	Corradi Matteo	
ITA		M	Coviello Simone	
ITA		M	Giuliani Achille	
ITA		M	Gotti Thomas	
ITA		M	LABIB RAMZY REZK ALVIN	
ITA		M	Licata Andrea	
ITA		M	Macchion Alessandro	
ITA		M	Marinelli Alessandro	
ITA		M	MATTEOTTI MARCO	
ITA		M	Nasser Diego	
ITA		M	Pappalardo Simone	
ITA		M	Parretta Filippo	
ITA		M	Passeri Salvatore	
ITA		M	Poenaru Alessio	
ITA		M	Privitera Victor	
ITA		M	TRIDENTE GIANLUIGI	
ITA		M	VILLANI MARIO	
KOS	KOS03294	M	SELIMI YLL	
KUW	KUW02905	M	ALQATAMI ABDULLAH	
LAT		M	Kryzhevskiy Yan	



Karate1 Youth League - Venice 2024

ENTRIES BY WEIGHT CATEGORY



U14 Kumite Male -55 kg

As of 8 DEC 2024

Country Code	ID	Gender	Name	Seeding
LAT		M	Pumpurs Andrejs	
MNE		M	ĐONBALJAJ ARDIT	
NED	SD81134	M	Castricum Ian	
NED	SD81133	M	Snoodijk Tigo	
PER		M	Medrano Uribe Flavio Gael	
POL	POL10974	M	BUBNOWSKI KAROL	
POL	POL05436	M	GAJDUS SZYMON	
POR		M	Figueiras Diogo	
POR		M	Pinto André	
ROU	ROU03613	M	BUICA MATEI	
SLO		M	Oblak David Kerim	
SLO		M	STERN TILEN	
SRB		M	Kosanovic Mateja	
SRB		M	Lazic Ilija	
SRB		M	Milić Todor	
SRB	SRB03733	M	POPOVIC JOVAN	
SUI		M	Gloor Leon	
SVK		M	Buda Michal	
SVK		M	Kubanka Dominik	
SVK		M	Kutlák Kamil	
SVK		M	Mrlian Adam Ján	
TUN	TUN003472	M	CHARABI MOHAMED YASINE	
TUR		M	Demirci Kayra Nejan	
UKR		M	Bilenkyi Oleksandr	
UKR		M	BILOKON BOHDAN	
UKR		M	Boiko Dmitrii	
UKR		M	Kononov Maksym	
UKR		M	PANKRATOV ROSTYSLAV	
UKR		M	Petrov Serhii	
UKR		M	Protasenko Andrii	
UKR		M	Pryndiuk Artem	
UKR		M	Ryha Andrii	
UKR		M	TADA KYRYLO	
UKR		M	Yatsko Kyryll	
VEN		M	Henriquez Manuel	

U14 Kumite Male -55 kg

Karate1 Youth League - Venice 2024, PALAZZO DEL TURISMO, Piazza Brescia 11, 30016 Lido di Jesolo VE, ITA

2024-12-08

Tatami
5 15:00

Pool
1/4

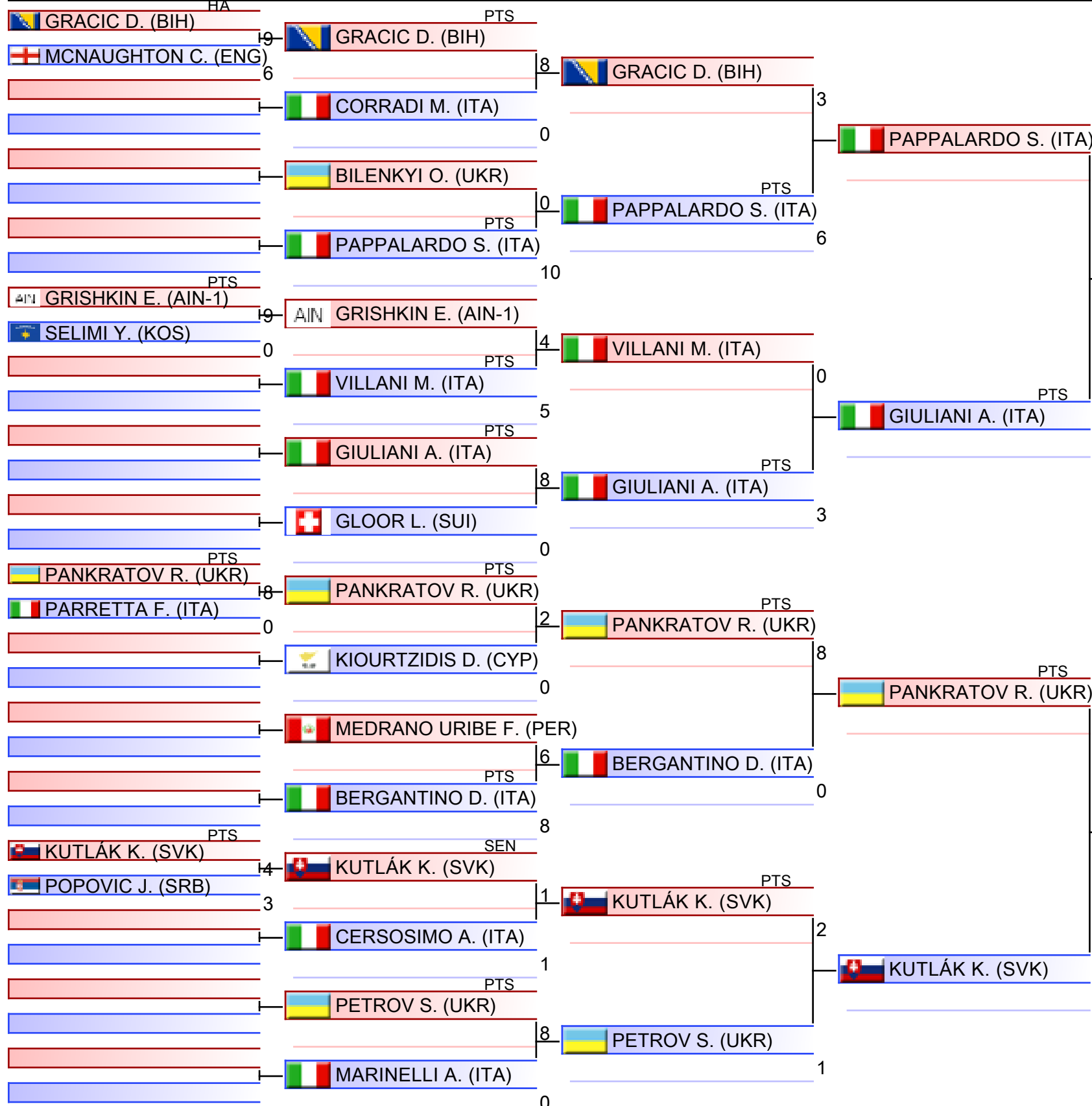

1. GIULIANI ACHILLE (ITA)
2. NASSER DIEGO (ITA)
3. MRLIAN ADAM JÁN (SVK)
3. ALQATAMI ABDULLAH (KUW)
5. PAPPALARDO SIMONE (ITA)
5. PRYNDIUK ARTEM (UKR)
7. PANKRATOV ROSTYSLAV (UKR)
7. BECKMANN MAX (GER)

U14 Kumite Male -55 kg

Karate1 Youth League - Venice 2024, PALAZZO DEL TURISMO, Piazza Brescia 11, 30016 Lido di Jesolo VE, ITA

2024-12-08

Tatami
6 15:00

Pool
2/4

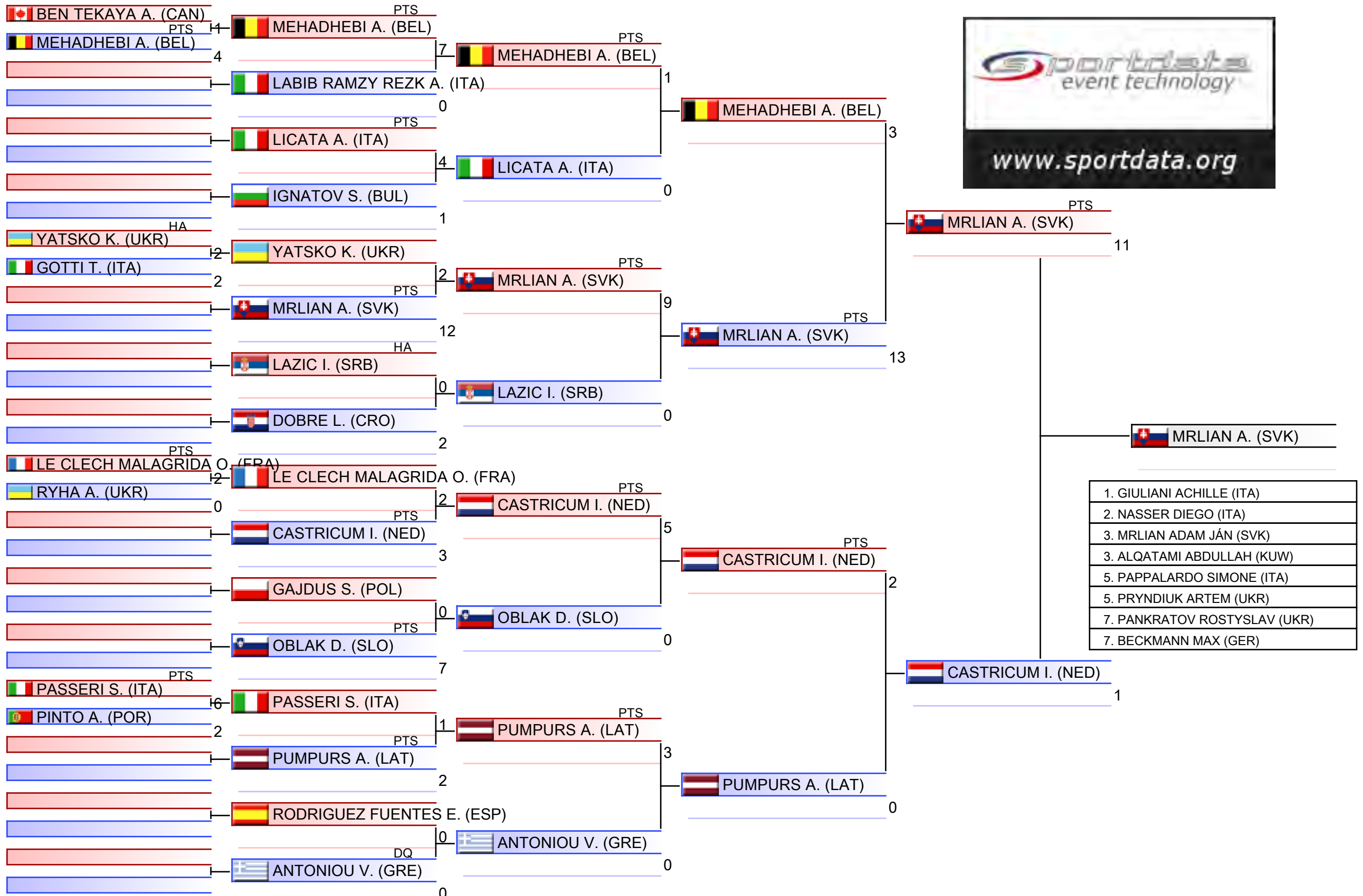

1.	GIULIANI ACHILLE (ITA)
2.	NASSER DIEGO (ITA)
3.	MRLIAN ADAM JÁN (SVK)
3.	ALQATAMI ABDULLAH (KUW)
5.	PAPPALARDO SIMONE (ITA)
5.	PRYNDIUK ARTEM (UKR)
7.	PANKRATOV ROSTYSLAV (UKR)
7.	BECKMANN MAX (GER)

U14 Kumite Male -55 kg

Karate1 Youth League - Venice 2024, PALAZZO DEL TURISMO, Piazza Brescia 11, 30016 Lido di Jesolo VE, ITA

2024-12-08

Tatami
7 15:00

Pool
3/4

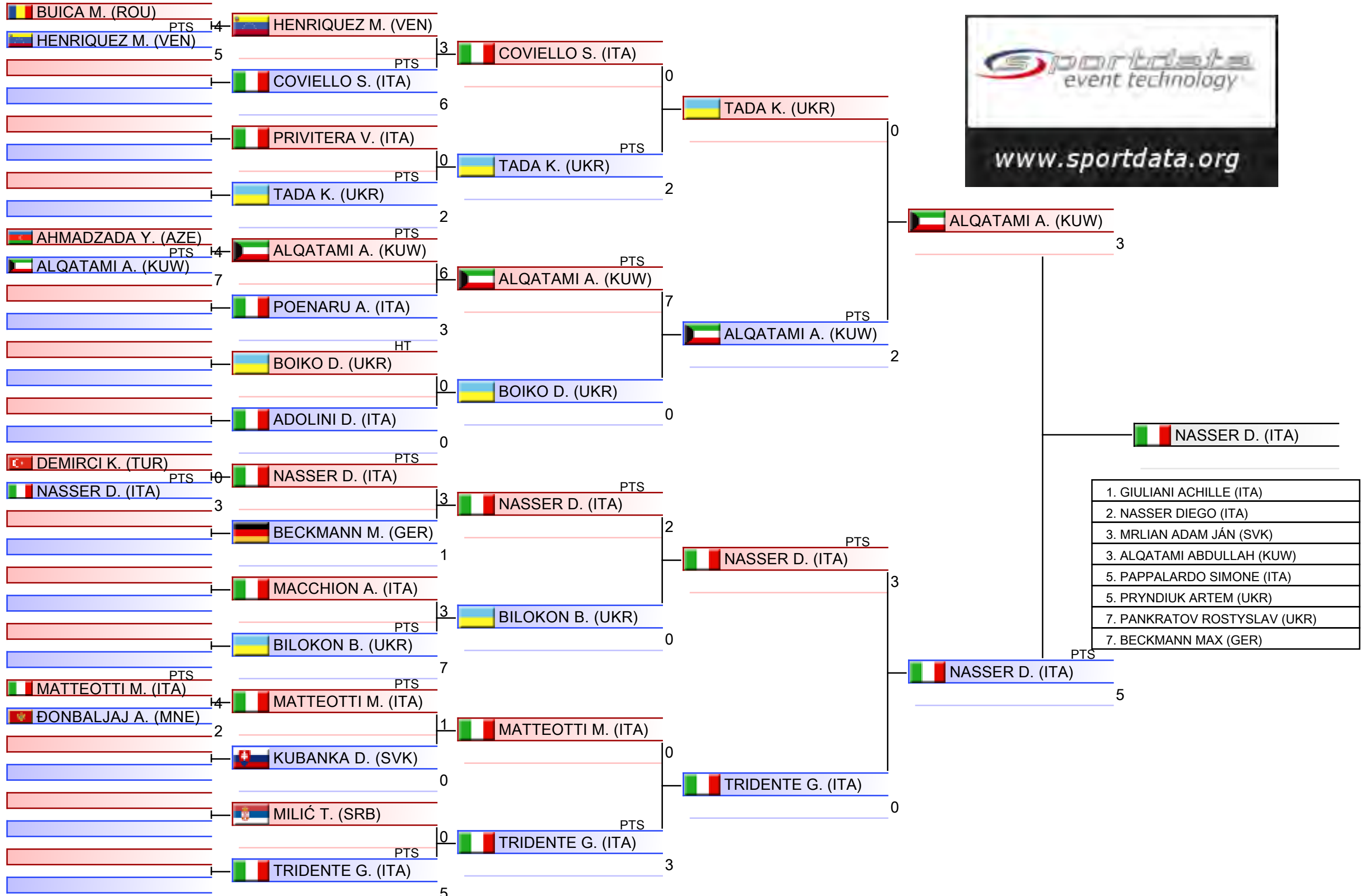

U14 Kumite Male -55 kg

Karate1 Youth League - Venice 2024, PALAZZO DEL TURISMO, Piazza Brescia 11, 30016 Lido di Jesolo VE, ITA

2024-12-08

Tatami
8 15:00

Pool
4/4

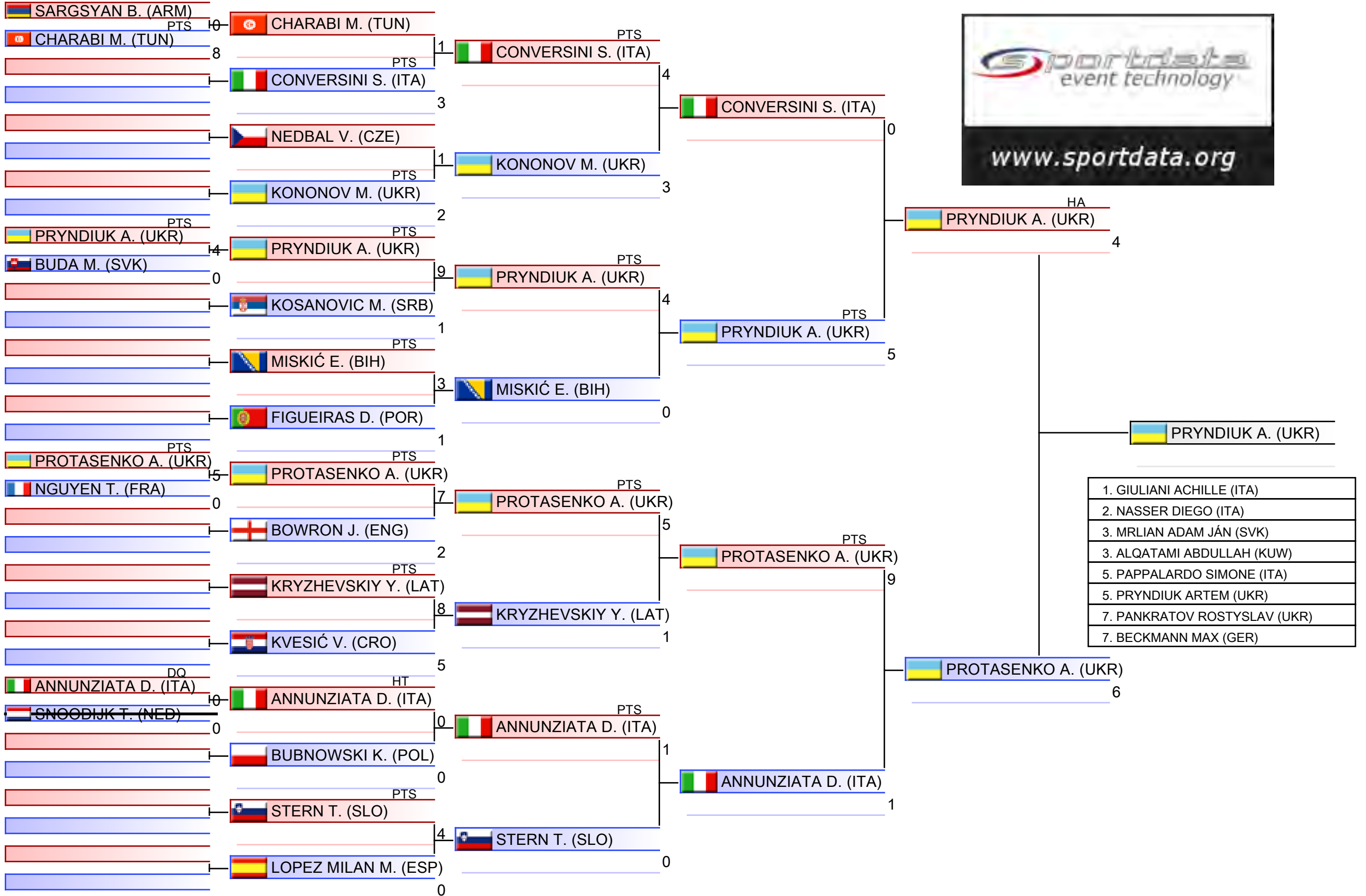

Pool winner-U14 Kumite Male -55 kg

Karate1 Youth League - Venice 2024, PALAZZO DEL TURISMO, Piazza Brescia 11, 30016 Lido di Jesolo VE, ITA

2024-12-08

Tatami
5 16:25

Pool
1/1

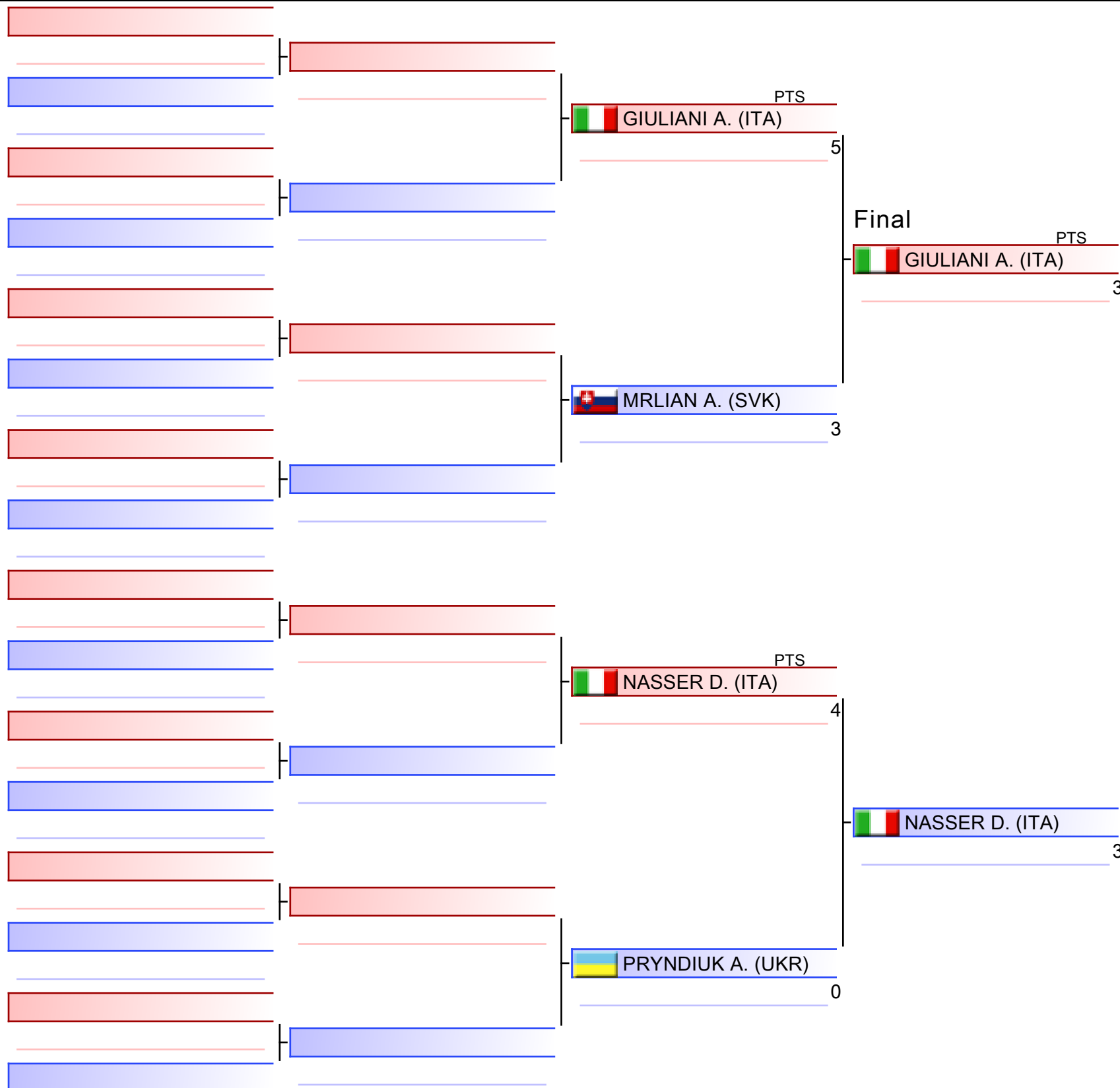

1. GIULIANI ACHILLE (ITA)
2. NASSER DIEGO (ITA)
3. MRLIAN ADAM JÁN (SVK)
3. ALQATAMI ABDULLAH (KUW)
5. PAPPALARDO SIMONE (ITA)
5. PRYNDIUK ARTEM (UKR)
7. PANKRATOV ROSTYSLAV (UKR)
7. BECKMANN MAX (GER)

U14 Kumite Male -55 kg

Karate1 Youth League - Venice 2024

2024-12-08

Tatami
6 18:05

Pool
2,1,3,4

(c)sportdata GmbH & Co KG 2000-2024 (2024-12-08 20:16) v 10.2.0 build 1 (2024-11-20 00:58 CET) License: SDIL TVG (expire 2025-01-26)

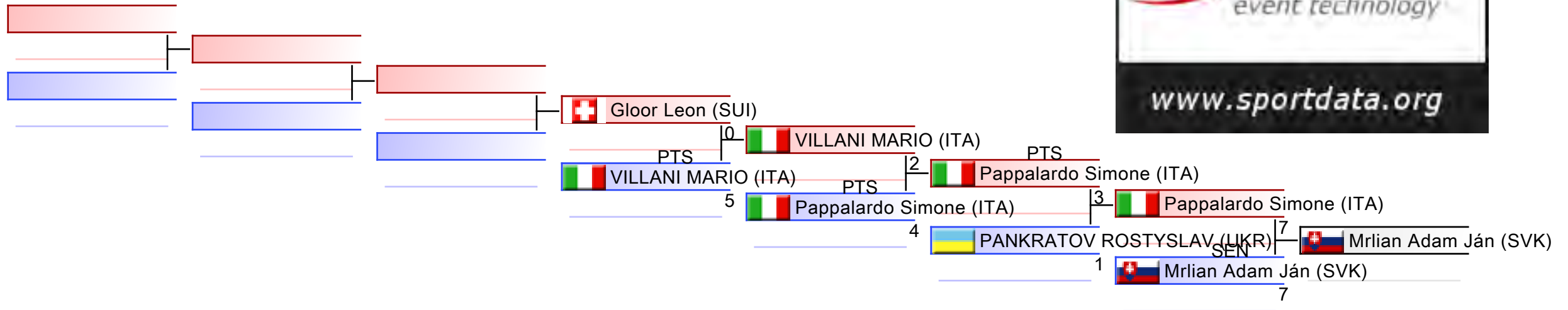

REPECHAGE: (2,1,3,4)

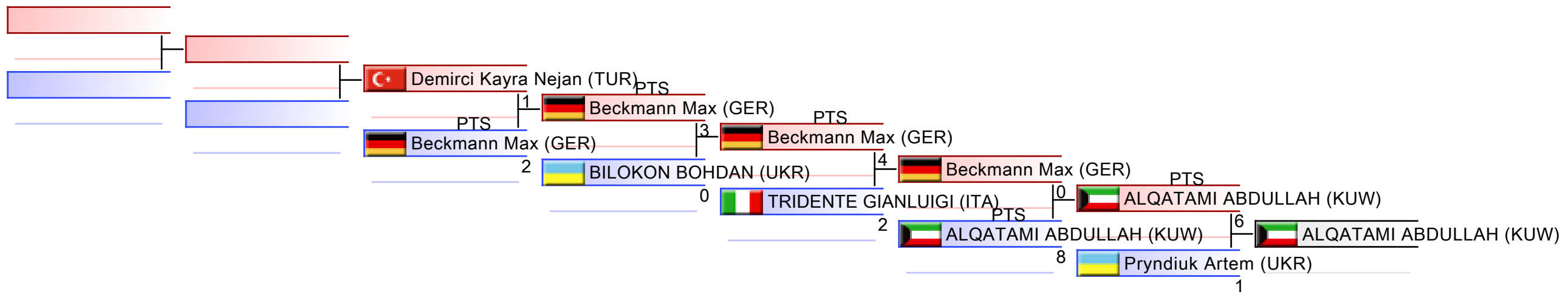



Karate1 Youth League - Venice 2024 - 2024-12-04



Official Results

U14 Kumite Male -55 kg (Entries: 80 Nations: 33)			
1	GIULIANI ACHILLE		ITA - ITALY
2	NASSER DIEGO		ITA - ITALY
3	MRLIAN ADAM JÁN		SVK - SLOVAKIA
3	ALQATAMI ABDULLAH		KUW - KUWAIT
5	PAPPALARDO SIMONE		ITA - ITALY
5	PRYNDIUK ARTEM		UKR - UKRAINE
7	PANKRATOV ROSTYSLAV		UKR - UKRAINE
7	BECKMANN MAX		GER - GERMANY
9	VILLANI MARIO		ITA - ITALY
9	TRIDENTE GIANLUIGI		ITA - ITALY
11	GLOOR LEON		SUI - SWITZERLAND
11	BILOKON BOHDAN		UKR - UKRAINE
13	DEMIRCI KAYRA NEJAN		TUR - TURKIYE

U21 KATA FEMALE



Karate1 Youth League - Venice 2024

ENTRIES BY WEIGHT CATEGORY



U21 Kata Female

As of 8 DEC 2024

Country Code	ID	Gender	Name	Seeding
BEL	BEL02370	F	MANCA CHIARA	
BIH		F	Pestalić Merjema	
BIH		F	Reiz Jasmina	
BIH		F	Stanojević Kristina	
CAN	CAN02675	F	CARTER BROOKLYN	
CRO		F	Burko Hannan	
CRO	CRO2281	F	GRGIC INGA	
CZE		F	Jůnová Adéla	
CZE	CZE02423	F	KIRSCHNEROVA ALICE-JANA	
CZE	CZE02247	F	ONDROUSKOVA AMALIE	
CZE	CZE02421	F	Šťastná Barbora	
CZE	CZE2171	F	TRTIKOVA MAGDALENA	
CZE	CZE02250	F	VACHOUTOVA BARBORA	
DEN		F	Nilsson Sara Lønbæk	
DEN	DEN02461	F	Spiegelhauer Chia	
ENG	ENG02772	F	Clow Amelia	
ENG	ENG02473	F	Holdsworth Eve	
ENG		F	Rees Ruby	
ENG	ENG02463	F	Reid Olivia	
ENG		F	Young Rebecca	
ESP		F	Guardeño Leon Carla	
ESP		F	MARTIN ALBA	
ESP		F	VICENTE MATEO EVA	
FRA	FRA02791	F	BUI Maï-Linh	
FRA		F	Locoge Maelle	
FRA		F	mous Sajia	
FRA	FRA02793	F	VINCENT KETHLEEN	
GER	GER03296	F	Bobbert Isabella	
GER	GER02952	F	Braun Anna	
GER	GER03273	F	Griessel Carolina	
GER		F	Hebbel Patricia	
GER	GER02850	F	Siebert Rita	
GER		F	Stevens Julie	
GER	GER02745	F	VLAJ JESSICA	
HKG	HKG002856	F	CHEUNG WING YI	
HKG	HKG02676	F	TAM CHEUK YI	
HUN		F	Hógenburg Luca	
IRI		F	Zeinali Helya	
IRL	IRL003051	F	OREILLY REBECCA	
ITA		F	Brambilla Chiara	
ITA	ITA03632	F	DE GREGORIO GABRIELLA	
ITA		F	Di Lelio Elena	
ITA		F	DOMINIJANNI ELISA	
ITA	ITA2111	F	D Onofrio Orsola	
ITA	ITA04221	F	ederar miriam	



Karate1 Youth League - Venice 2024

ENTRIES BY WEIGHT CATEGORY



U21 Kata Female

As of 8 DEC 2024

Country Code	ID	Gender	Name	Seeding
ITA		F	Gabba Giada	
ITA	ITA04185	F	GRUPPIONI ASIA	
ITA		F	La Macchia Cristina	
ITA	ITA03537	F	MARCELLI ANNA	
ITA	ITA03539	F	Marchetti Giulia	
ITA		F	MESAGLIO MARTINA	
ITA	ITA03808	F	MUGNANI MIRIAM	
ITA		F	Pagliari Martina	
ITA		F	rigoni clelia	
ITA		F	ROSSI Giulia	
ITA	ITA04249	F	SERINELLI AURORA	
ITA	ITA04275	F	Stangherlin Sofia	
ITA	ITA02872	F	Tagliaferro Chiara	
ITA	ITA04222	F	VIELMI ELISA	
ITA	ITA04518	F	ZORI ANNA	
KOS	KOS2125	F	LOKI ALMA	
MDA	MDA02342	F	BEREZOVSCAIA ELENA	
MLT	MLT02319	F	CONTI ELEONORA	
MLT	MLT2116	F	VELLA JESSICA	
NED	NED03278	F	van Rest Merah	
PER	PER02563	F	Valdivia Monzon Alexandra Sofia	
POL	POL3271	F	Dmytruszyńska Monika	
POL	POL2567	F	Toś Wiktoria	
POL	POL06216	F	WIECZORKIEWICZ WIKTORIA	
POR	POR02715	F	Cardoso Maria	
POR	POR02712	F	Martins Rita	
POR	POR02716	F	Ribeiro Barbara	
POR	POR02713	F	Santos Rita	
POR	SD75079	F	Teixeira Lara	
ROU	ROU02981	F	BANEASU MICHELLE	
SRB	SRB03266	F	Nikolic Mina	
SUI	SUI02270	F	Buchser Anel	
SUI	SUI02684	F	Gallimore Kim	
SUI	SUI02567	F	Pelladoni Gina	
SUI	SUI02277	F	Tschanz Olivia	
SVK		F	GAMOVA Natasa	
SVK	SD12132	F	Glatzová Barbora	
SVK		F	Hrnčáriková Marika	
SWE	SWE	F	Lyngbäck Agnes	
TTO	TRI02132	F	LUE FATT MICHELLE	

U21 Kata Female

Karate1 Youth League - Venice 2024, PALAZZO DEL TURISMO, Piazza Brescia 11, 30016 Lido di Jesolo VE, ITA

2024-12-04

Tatami
5 09:00

Pool
1/4

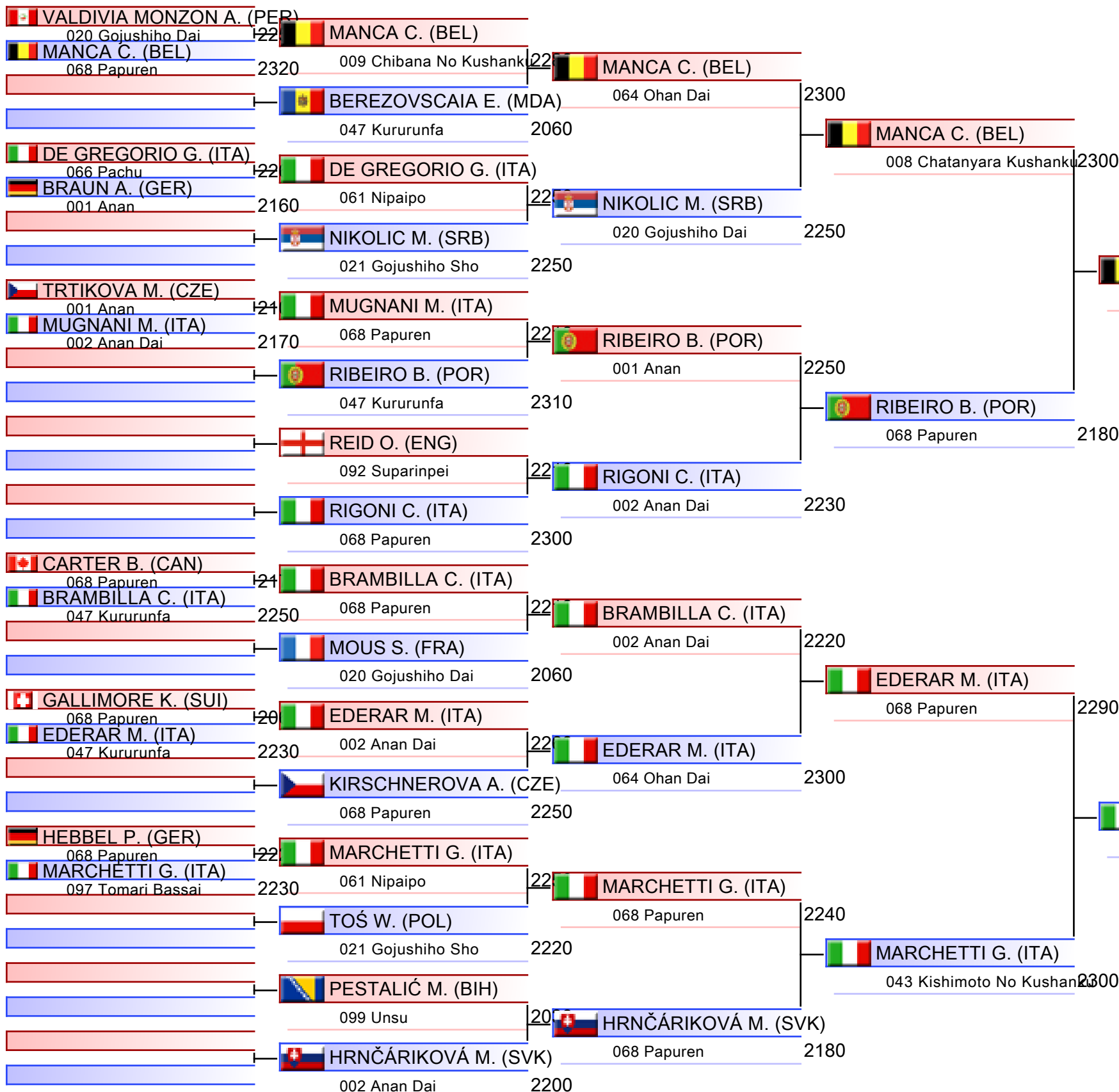

- | |
|---------------------------|
| 1. MANCA CHIARA (BEL) |
| 2. BUI MAÏ-LINH (FRA) |
| 3. MARTIN ALBA (ESP) |
| 3. MARCHETTI GIULIA (ITA) |
| 5. GAMOVA NATASA (SVK) |
| 5. VLAI JESSICA (GER) |
| 7. TEIXEIRA LARA (POR) |
| 7. RIBEIRO BARBARA (POR) |

U21 Kata Female

Karate1 Youth League - Venice 2024, PALAZZO DEL TURISMO, Piazza Brescia 11, 30016 Lido di Jesolo VE, ITA

2024-12-04

Tatami
6 09:00

Pool
2/4

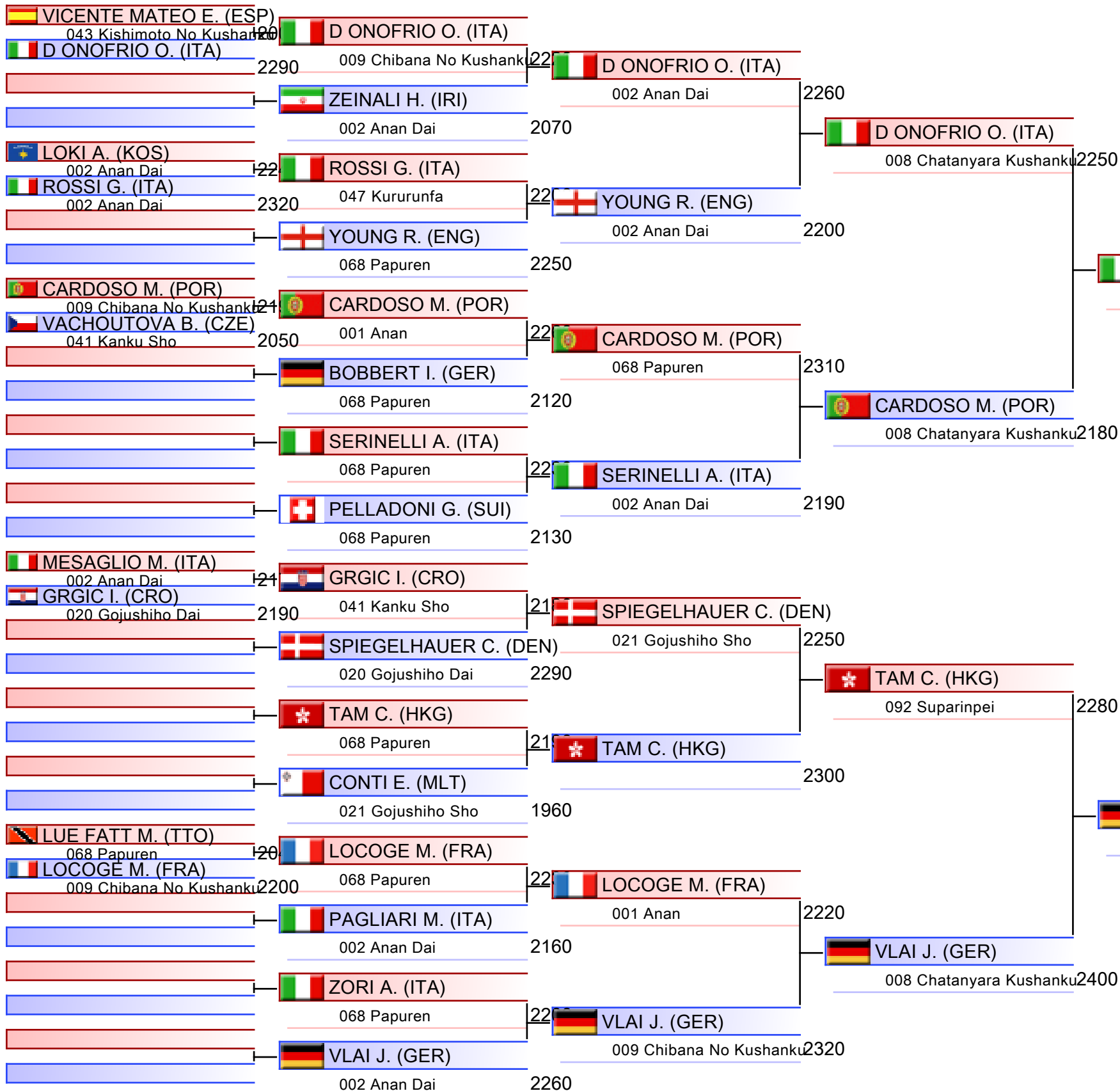

- | |
|---------------------------|
| 1. MANCA CHIARA (BEL) |
| 2. BUI MAÏ-LINH (FRA) |
| 3. MARTIN ALBA (ESP) |
| 3. MARCHETTI GIULIA (ITA) |
| 5. GAMOVA NATASA (SVK) |
| 5. VLAI JESSICA (GER) |
| 7. TEIXEIRA LARA (POR) |
| 7. RIBEIRO BARBARA (POR) |

U21 Kata Female

Karate1 Youth League - Venice 2024, PALAZZO DEL TURISMO, Piazza Brescia 11, 30016 Lido di Jesolo VE, ITA

2024-12-04

Tatami
8 09:00

Pool
4/4

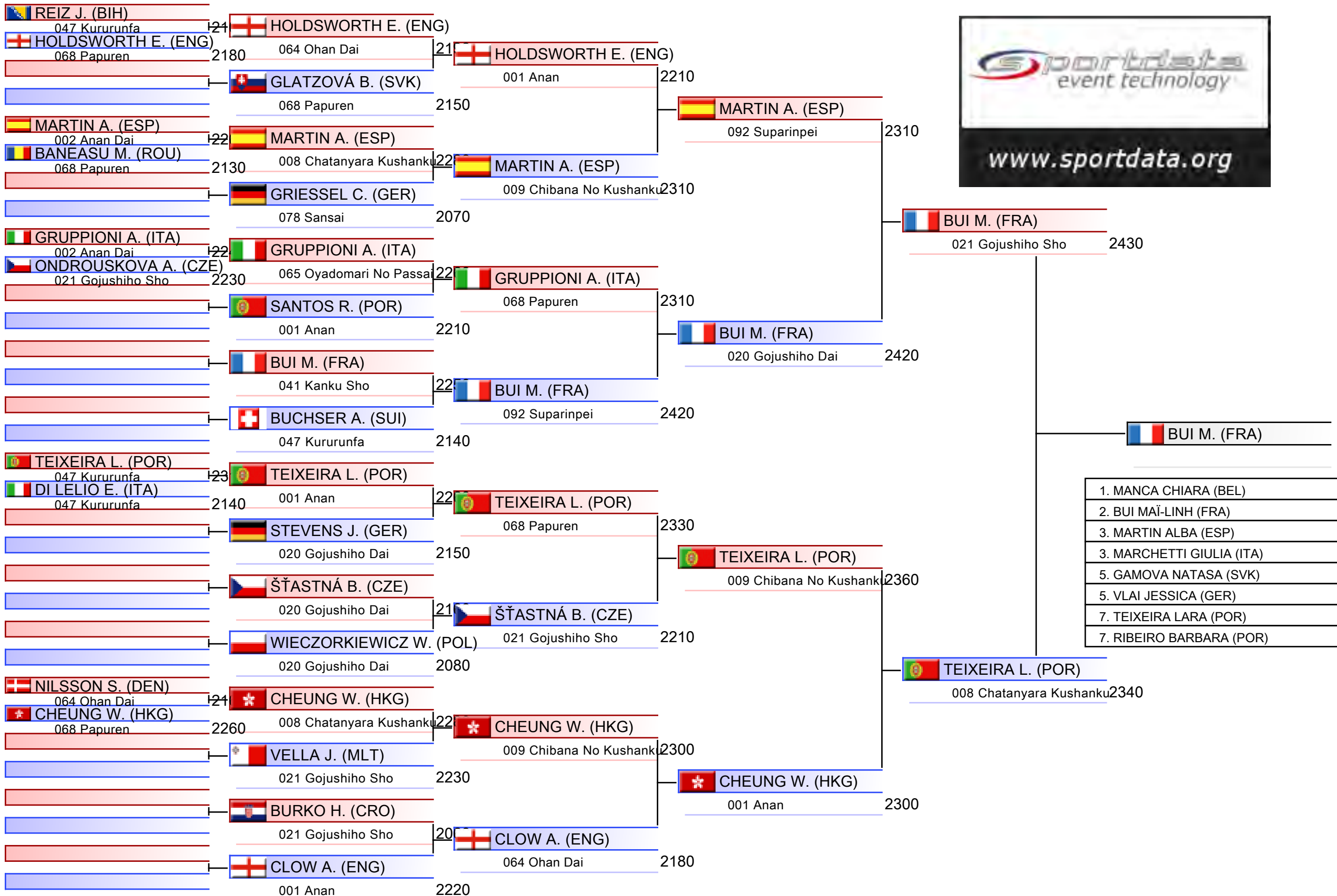

1.	MANCA CHIARA (BEL)
2.	BUI MAÏ-LINH (FRA)
3.	MARTIN ALBA (ESP)
3.	MARCHETTI GIULIA (ITA)
5.	GAMOVA NATASA (SVK)
5.	VLAI JESSICA (GER)
7.	TEIXEIRA LARA (POR)
7.	RIBEIRO BARBARA (POR)

Pool winner-U21 Kata Female

Karate1 Youth League - Venice 2024, PALAZZO DEL TURISMO, Piazza Brescia 11, 30016 Lido di Jesolo VE, ITA

2024-12-04

Tatami

7 11:20

Pool

1/1

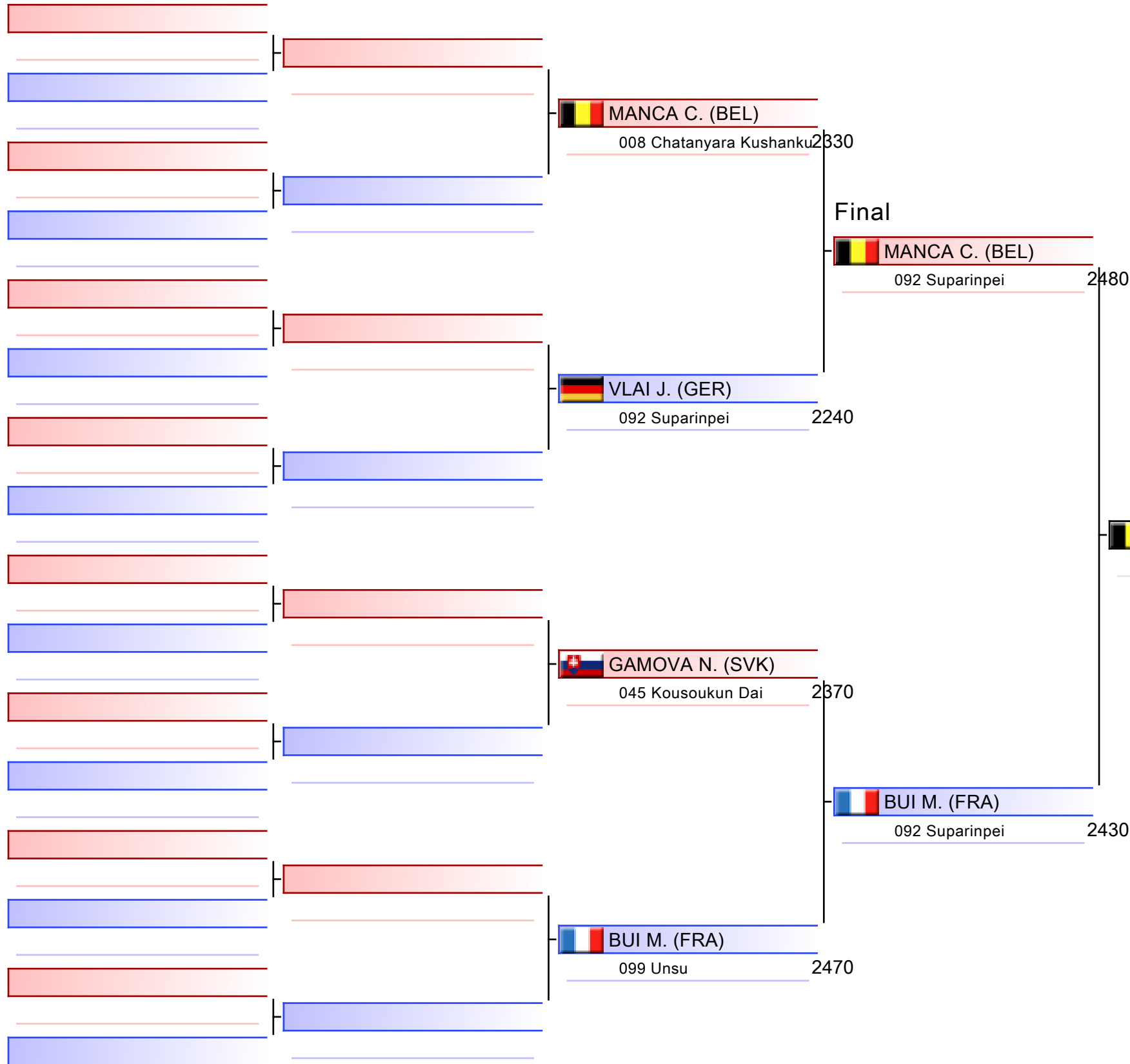

1. MANCA CHIARA (BEL)
2. BUI MAÏ-LINH (FRA)
3. MARTIN ALBA (ESP)
3. MARCHETTI GIULIA (ITA)
5. GAMOVA NATASA (SVK)
5. VLAI JESSICA (GER)
7. TEIXEIRA LARA (POR)
7. RIBEIRO BARBARA (POR)

U21 Kata Female

Karate1 Youth League - Venice 2024

2024-12-04

Tatami

3 11:50

Pool

1,2

(c)sportdata GmbH & Co KG 2000-2024 (2024-12-08 20:16) v 10.2.0 build 1 (2024-11-20 00:58 CET) License: SDIL TVG (expire 2025-01-26)

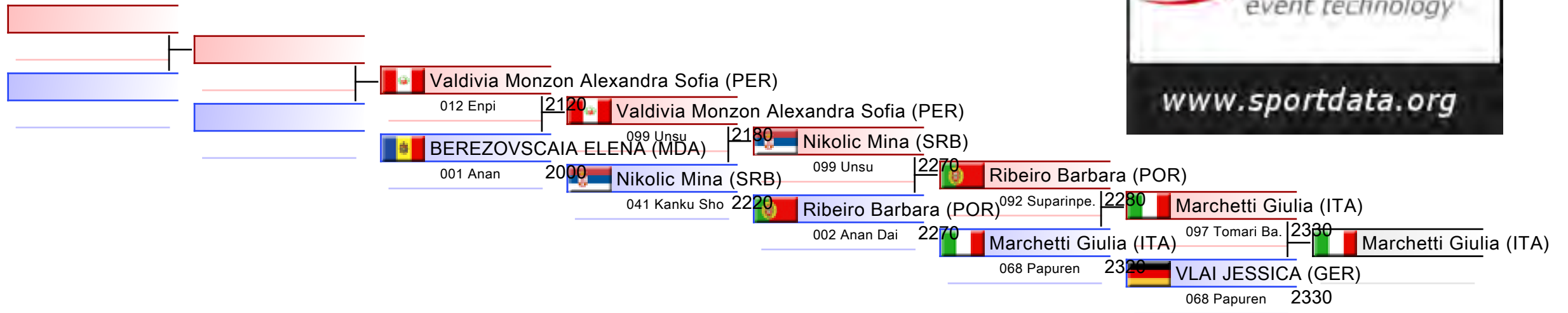

REPECHAGE: (1,2)

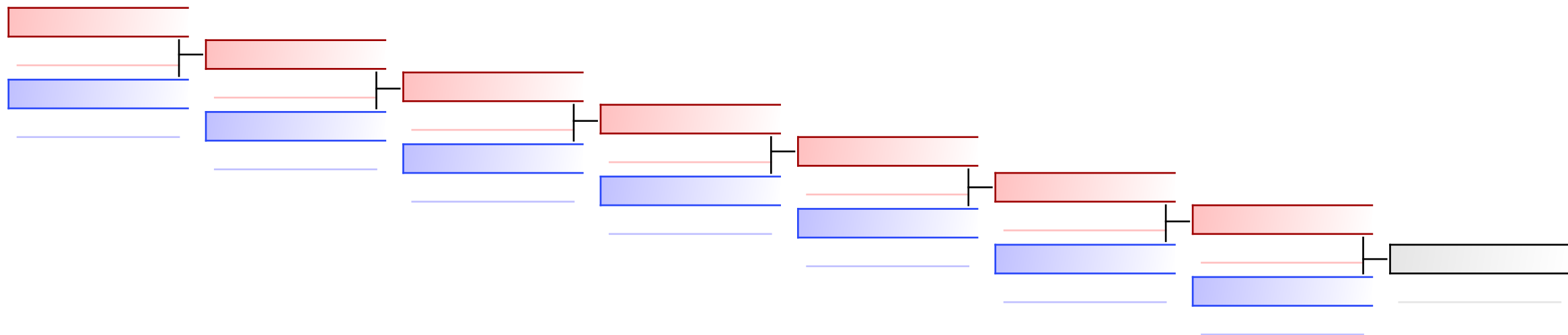

U21 Kata Female

Karate1 Youth League - Venice 2024

2024-12-04

Tatami

4 11:50

Pool

3,4

(c)sportdata GmbH & Co KG 2000-2024 (2024-12-08 20:16) v 10.2.0 build 1 (2024-11-20 00:58 CET) License: SDIL TVG (expire 2025-01-26)

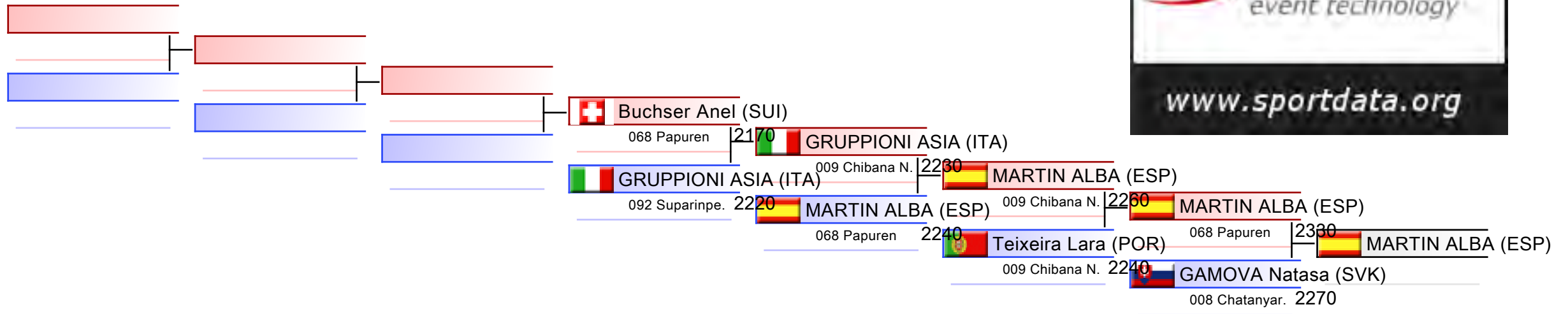

REPECHAGE: (3,4)

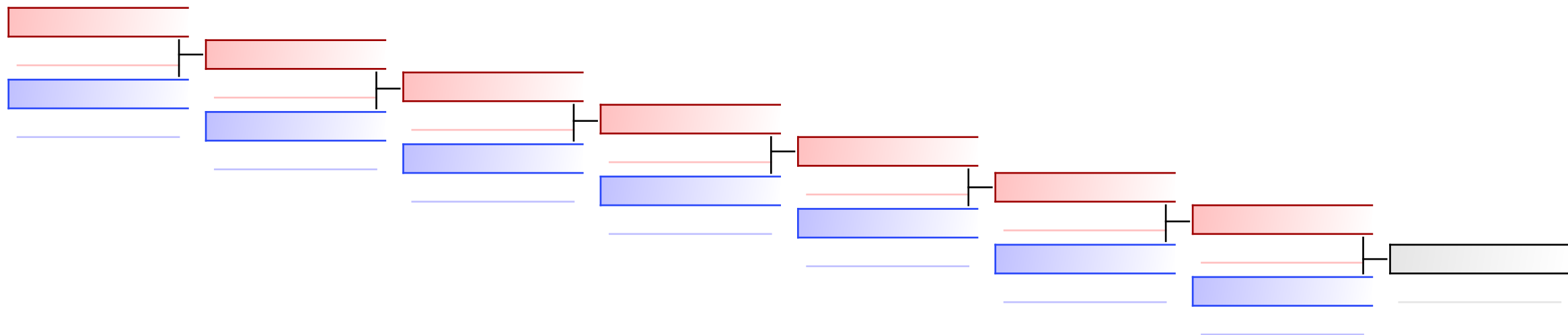



Karate1 Youth League - Venice 2024 - 2024-12-04



Official Results

U21 Kata Female (Entries: 85 Nations: 28)			
1	MANCA CHIARA		BEL - BELGIUM
2	BUI MAI-LINH		FRA - FRANCE
3	MARTIN ALBA		ESP - SPAIN
3	MARCHETTI GIULIA		ITA - ITALY
5	GAMOVA NATASA		SVK - SLOVAKIA
5	VLAI JESSICA		GER - GERMANY
7	TEIXEIRA LARA		POR - PORTUGAL
7	RIBEIRO BARBARA		POR - PORTUGAL
9	GRUPPIONI ASIA		ITA - ITALY
9	NIKOLIC MINA		SRB - SERBIA
11	BUCHSER ANEL		SUI - SWITZERLAND
11	VALDIVIA MONZON ALEXANDRA SOFIA		PER - PERU
13	BEREZOVSCAIA ELENA		MDA - MOLDOVA, REPUBLIC OF

U21 KATA MALE



Karate1 Youth League - Venice 2024

ENTRIES BY WEIGHT CATEGORY



U21 Kata Male

As of 8 DEC 2024

Country Code	ID	Gender	Name	Seeding
AUT	AUT02673	M	Wagner Felix	
AUT	AUT02600	M	ZOECHLING FLORIAN	
BIH	BIH004859	M	SERDAREVIC NEDIM	
BIH	BIH2218	M	Veladžić Senaid	
BUL	BUL2139	M	Matuski Georgi	
COL	COL02635	M	LOPEZ GABRIEL	
CRO	CRO03015	M	HUIC DINO	
CZE	CZE02212	M	POHL FILIP	
CZE	CZE02474	M	STAHLAVSKY ONDREJ	
CZE	CZE02422	M	Stránský Jan	
CZE	CZE2169	M	SUKAL VOJTECH	
CZE		M	Vrátný Vojtěch	
DEN		M	Mikkelsen Nicolas	
ENG		M	Barnes Dylan	
ENG		M	Panday Cameron	
ENG		M	Pratley Jaime	
ENG		M	Rowe Brandon	
ESP		M	Alonso Céspedes Héctor	
ESP		M	CONTRERAS CABRERA DIEGO ANDRÉS	
ESP		M	IGLESIAS GARCÍA MANUEL	
FIN		M	Takala Akseli	
FRA	FRA03515	M	BITOUN Matthieu	
FRA		M	BOMPAS JANHAEL	
FRA	SD77904	M	Casas Nathan	
FRA	FRA03460	M	GREGOIRE Liam	
FRA	FRA02808	M	HOFFMANN LUCAS	
FRA	FRA02789	M	NOUR MAURIS Lorick	
FRA	FRA03296	M	PELTIER Tom	
GER		M	Aleksiev Antonov Aleks	
GER	GER02852	M	LUECK AARIC LAM	
GER		M	Reiter Patrick	
GER		M	Ziza Rayan	
HKG	HKG02474	M	CHIU CHUN YIN	
HKG	HKG02383	M	KWOK HO HIM	
HUN		M	Bárdos Ádám	
HUN	HUN02535	M	Berczes Botond	
HUN	HUN02536	M	Elekes Máté	
IRI		M	Naghdi Mohammad Mahdi	
IRL	IRL02652	M	HOLOHAN CONOR	
ITA	ITA04212	M	BOMBARDI LEONARDO	
ITA	ITA04499	M	Calabrese Luca	
ITA		M	Corvaglia Samuele	
ITA	ITA04186	M	COSCI GIUSEPPE	
ITA	ITA04223	M	ederar karim	
ITA	ITA04238	M	Fuscagni Alex	



Karate1 Youth League - Venice 2024

ENTRIES BY WEIGHT CATEGORY



U21 Kata Male

As of 8 DEC 2024

Country Code	ID	Gender	Name	Seeding
ITA		M	Galeotti Thomas	
ITA		M	Giovagnoni Gioele	
ITA	ITA03014	M	JIGAU MARCO LEONARDO	
ITA	ITA04187	M	MATACCHIONI LUIGI	
ITA	ITA02987	M	Mazzarello Andrea	
ITA		M	MIRTO ALESSANDRO	
ITA		M	Monza Andrea	
ITA	ITA02968	M	MOSCATELLI SAMUELE	
ITA	ITA03831	M	Pappalardo Vincenzo	
ITA	ITA03045	M	Polsinelli Guido	
ITA		M	ROSIELLO GIUSEPPE	
ITA	ITA04278	M	Rossi Francesco	
ITA	ITA04226	M	SERGI FRANCESCO	
ITA		M	Vacca Thomas	
ITA	ITA03067	M	Villano Cristian	
ITA	ITA04500	M	Zanirato Francesco	
ITA	ITA03062	M	Zelante Nunzio	
LUX	LUX02431	M	Chaffort Lucas	
MNE		M	MILIĆ NIKOLA	
POL	POL2937	M	IWASZKIEWICZ PIOTR	
POL		M	Małcki Michał	
POL	POL2951	M	NIEDZIELA WOJCIECH	
POR	POR02702	M	Proença Ruben	
ROU	ROU2480	M	COMANESCU PETRU	
SCO		M	Salehi Shakar	
SLO	SLO02797	M	MESANOVIC BENJAMIN	
SLO	SLO003084	M	PIVIC EVELIN	
SLO	SLO2458	M	SLUGA JURE	
SRB	SRB2536	M	Boškov Aleksandar	
SUI	SUI003155	M	PETRONE Leandro	
SUI	SUI02236	M	Schedel Keni	
SUI	SUI02274	M	Schertenleib Janik Timo	
SVK	SVK02799	M	Filip Denis	
SVK	SVK2210	M	Kodaj Simon	
SVK	SVK02689	M	Miklovics Damian	
SVK		M	WEINREB Dominik	
SWE	SWE02388	M	TRAN WILLIAM	
TKM	TKM02034	M	ATAJANOV RASUL	
TUR		M	Parlak Ozan	
TUR		M	YILDIRIM ATEŞ EFE	
UKR	UKR2366	M	Fedorov Yaroslav	
UKR	UKR02541	M	Skrypnyk Artem	
UKR	UKR02919	M	SOKOLOV HLIB	

U21 Kata Male

Karate1 Youth League - Venice 2024, PALAZZO DEL TURISMO, Piazza Brescia 11, 30016 Lido di Jesolo VE, ITA

2024-12-04

Tatami
1 09:00

Pool
1/4

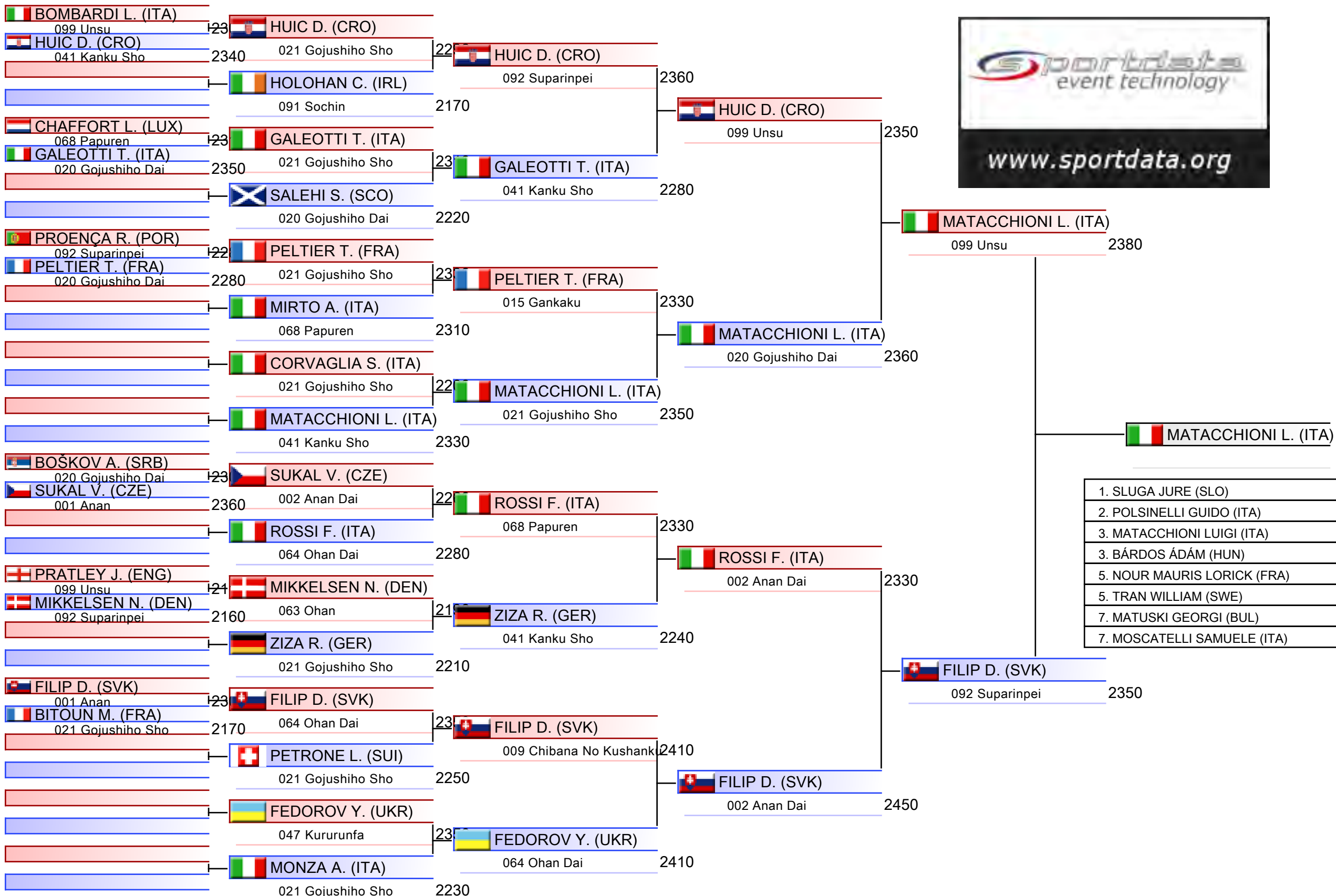

U21 Kata Male

Karate1 Youth League - Venice 2024, PALAZZO DEL TURISMO, Piazza Brescia 11, 30016 Lido di Jesolo VE, ITA

2024-12-04

Tatami
2 09:00

Pool
2/4

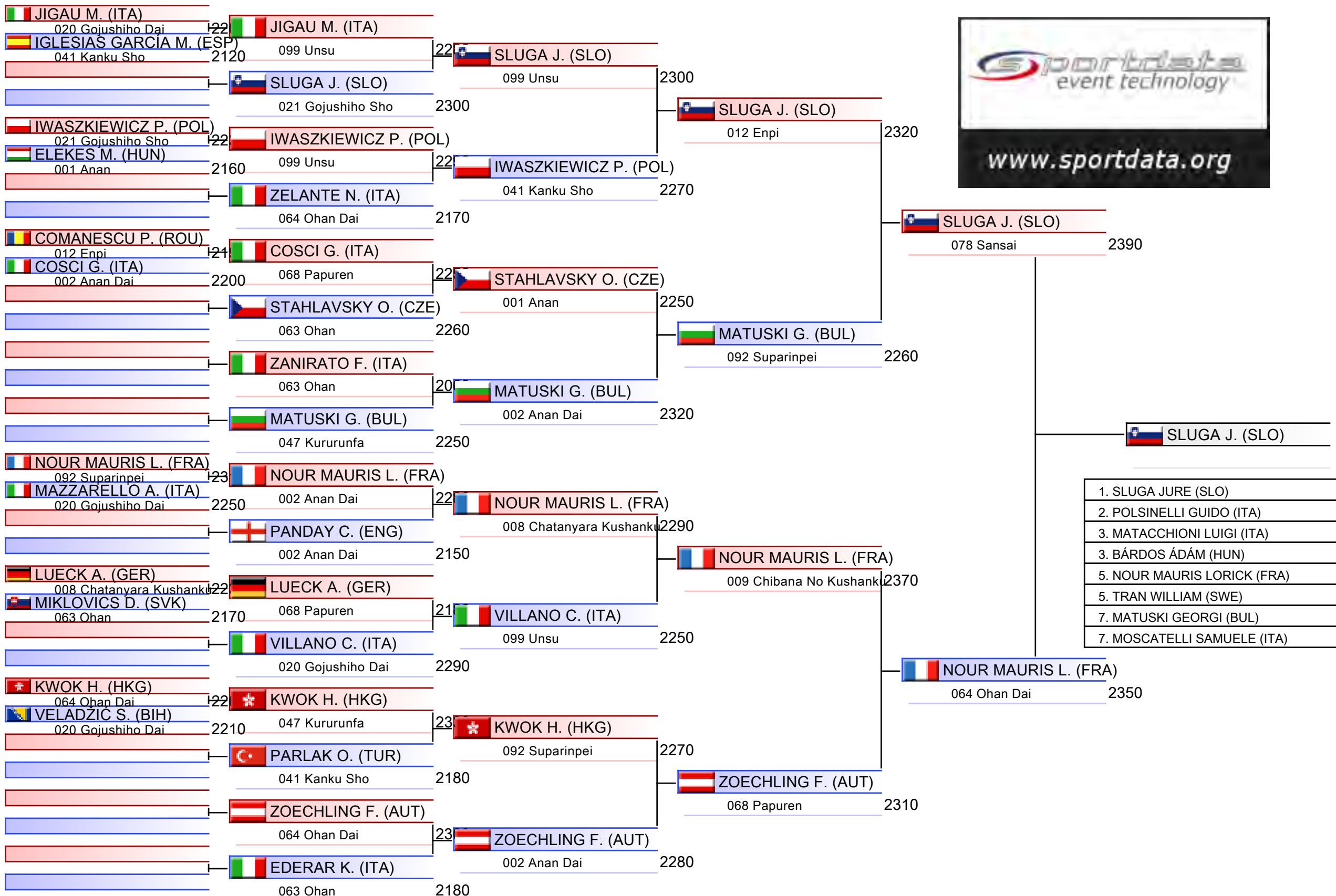

1. SLUGA JURE (SLO)
2. POLSINELLI GUIDO (ITA)
3. MATAACCHIONI LUIGI (ITA)
3. BÁRDOS ÁDÁM (HUN)
5. NOUR MAURIS LORICK (FRA)
5. TRAN WILLIAM (SWE)
7. MATUSKI GEORGI (BUL)
7. MOSCATELLI SAMUELE (ITA)

U21 Kata Male

Karate1 Youth League - Venice 2024, PALAZZO DEL TURISMO, Piazza Brescia 11, 30016 Lido di Jesolo VE, ITA

2024-12-04

Tatami
3 09:00

Pool
3/4

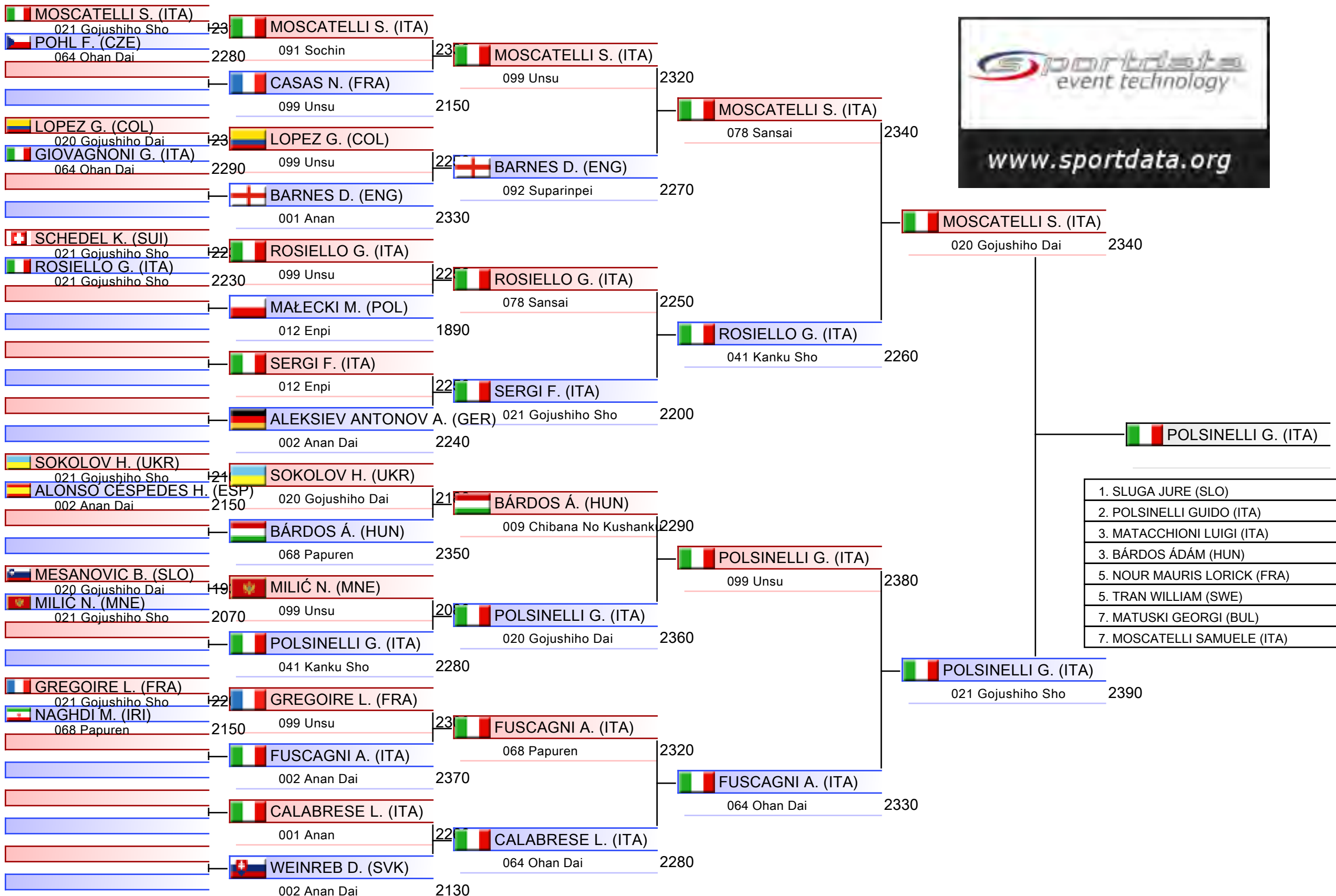

U21 Kata Male

Karate1 Youth League - Venice 2024, PALAZZO DEL TURISMO, Piazza Brescia 11, 30016 Lido di Jesolo VE, ITA

2024-12-04

Tatami
4 09:00

Pool
4/4

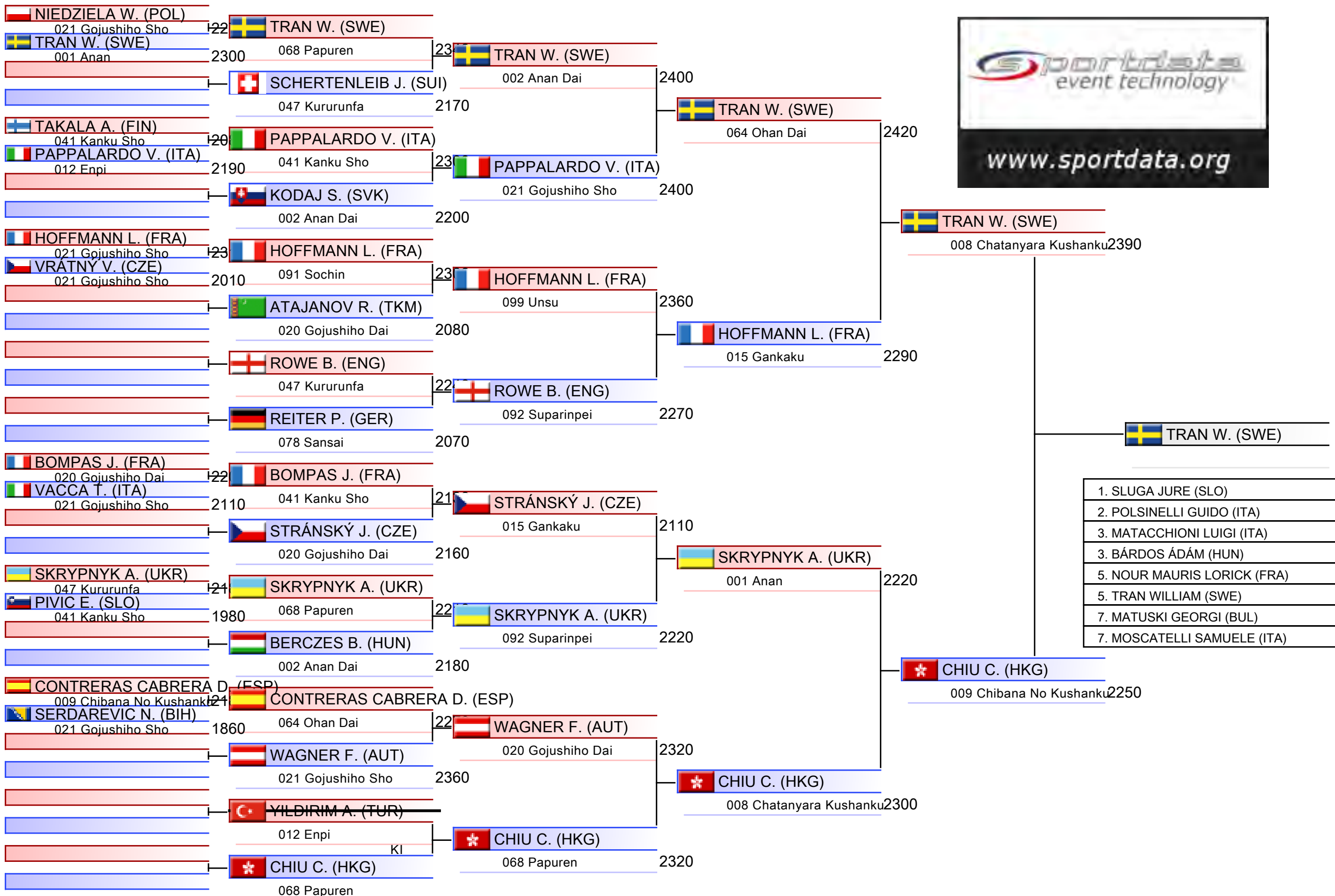

Pool winner-U21 Kata Male

Karate1 Youth League - Venice 2024, PALAZZO DEL TURISMO, Piazza Brescia 11, 30016 Lido di Jesolo VE, ITA

2024-12-04

Tatami

1 11:30

Pool

1/1

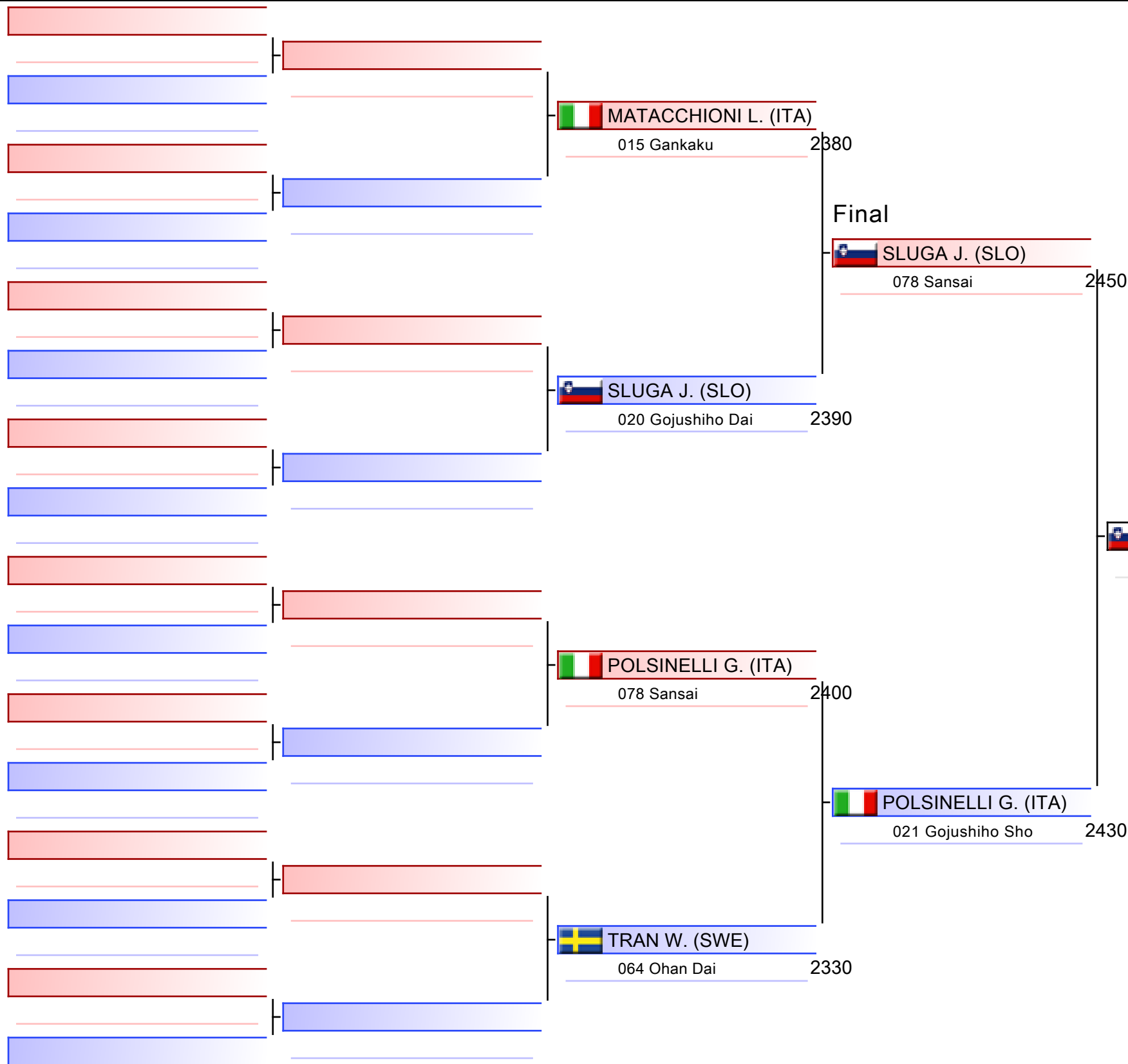

1. SLUGA JURE (SLO)
2. POLSINELLI GUIDO (ITA)
3. MATAACCHIONI LUIGI (ITA)
3. BÁRDOS ÁDÁM (HUN)
5. NOUR MAURIS LORICK (FRA)
5. TRAN WILLIAM (SWE)
7. MATUSKI GEORGI (BUL)
7. MOSCATELLI SAMUELE (ITA)

U21 Kata Male

Karate1 Youth League - Venice 2024

2024-12-04

Tatami

1 11:50

Pool

1,2

(c)sportdata GmbH & Co KG 2000-2024 (2024-12-08 20:16) v 10.2.0 build 1 (2024-11-20 00:58 CET) License: SDIL TVG (expire 2025-01-26)

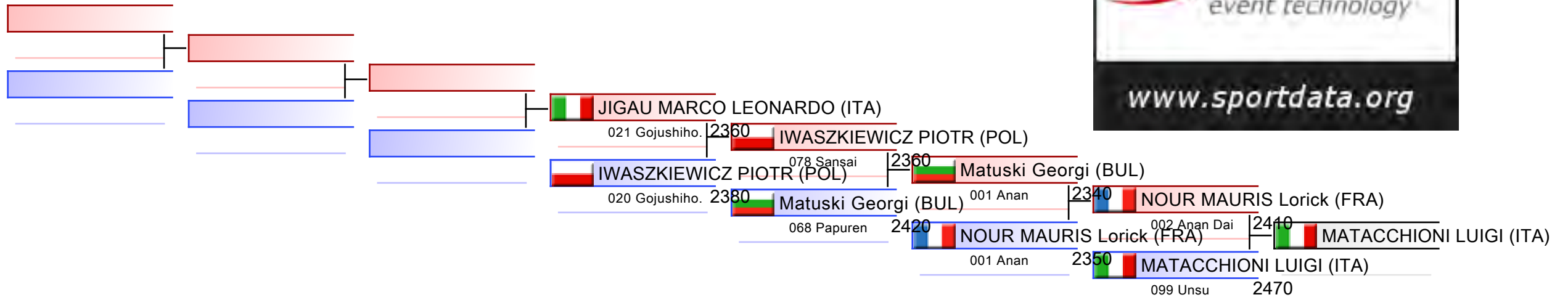

REPECHAGE: (1,2)

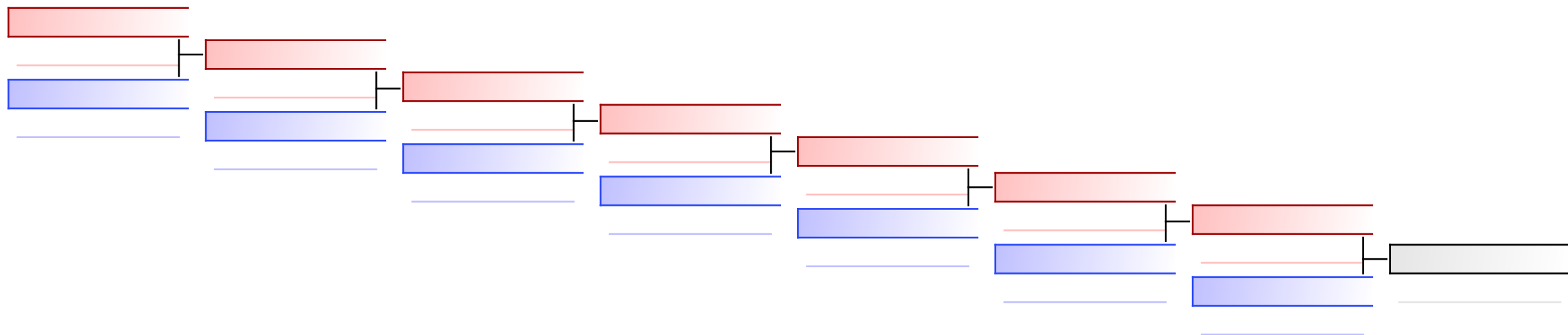

U21 Kata Male

Karate1 Youth League - Venice 2024

2024-12-04

Tatami
2 11:50

Pool
3,4

(c)sportdata GmbH & Co KG 2000-2024 (2024-12-08 20:16) v 10.2.0 build 1 (2024-11-20 00:58 CET) License: SDIL TVG (expire 2025-01-26)

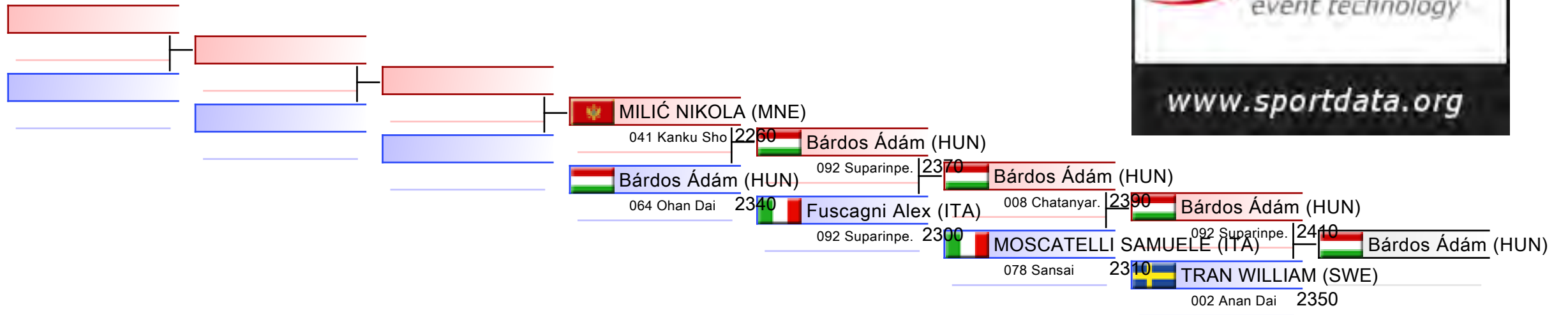

REPECHAGE: (3,4)

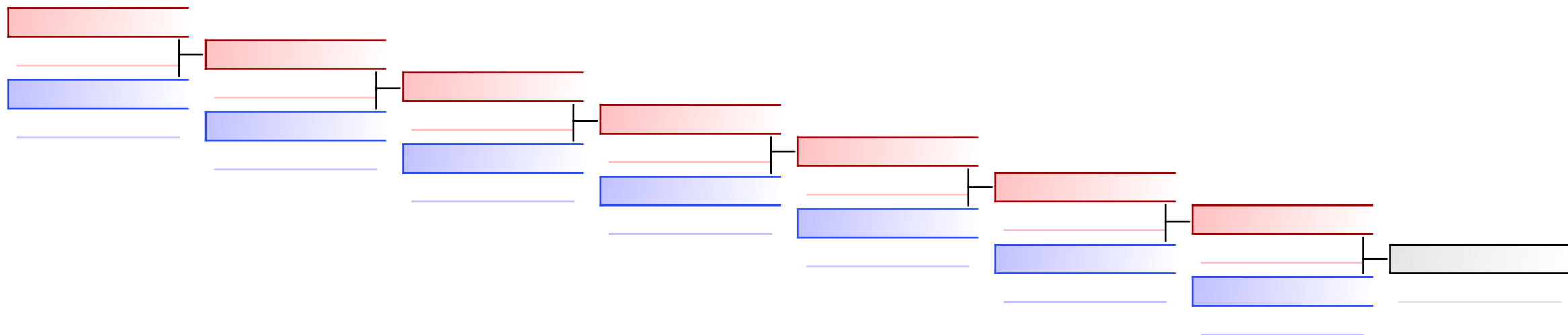



Karate1 Youth League - Venice 2024 - 2024-12-04



Official Results

U21 Kata Male (Entries: 88 Nations: 31)			
1	SLUGA JURE		SLO - SLOVENIA
2	POLSINELLI GUIDO		ITA - ITALY
3	MATACCHIONI LUIGI		ITA - ITALY
3	BÁRDOS ÁDÁM		HUN - HUNGARY
5	NOUR MAURIS LORICK		FRA - FRANCE
5	TRAN WILLIAM		SWE - SWEDEN
7	MATUSKI GEORGI		BUL - BULGARIA
7	MOSCATELLI SAMUELE		ITA - ITALY
9	IWASZKIEWICZ PIOTR		POL - POLAND
9	FUSCAGNI ALEX		ITA - ITALY
11	JIGAU MARCO LEONARDO		ITA - ITALY
11	MILIĆ NIKOLA		MNE - MONTENEGRO

U21 KUMITE FEMALE -50 KG



Karate1 Youth League - Venice 2024

ENTRIES BY WEIGHT CATEGORY



U21 Kumite Female -50 kg

As of 8 DEC 2024

Country Code	ID	Gender	Name	Seeding
AIN-2		F	MARKAVA ULYANA	
BEL	BEL02286	F	Dehaes Lena	
BIH	BIH2596	F	Hodzic Sara	
BIH	BIH03852	F	Hrbat Elmedina	
BUL	BUL2210	F	Tsaneva Teodora	
CAN	CAN02672	F	MOKDAD MAROUA	
CHI	CHI2250	F	GODOY MAGDALENA	
CRO	CRO03812	F	BERIŠA TONKA	
CRO	CRO03382	F	Kirinić Lucija	
CRO	CRO2209	F	SGARDELLI EMA	
ENG	ENG02822	F	Gramaticu Denisa A	
ENG	SD62197	F	SLADE MILLIE	
ESA	ESA02177	F	ORANTES MAGANA SOFIA ALEJANDRA	
ESP		F	Guardesño Leon Carla	
ESP	ESP02675	F	VIZUETE MIREIA	
FRA	FRA03276	F	COCHARD Marylou	
GER	GER02725	F	Ott Sidney-Michelle	
HUN	HUN2389	F	Hecker Bojana	
ITA	ITA04240	F	Bifulco Asia	
ITA		F	BOSIO MATILDE	
ITA	ITA04569	F	Brandimarte Gioia	
ITA	ITA04298	F	COLLETTI EMMA	
ITA	ITA03065	F	DE ANGELIS MARTINA	
ITA		F	Federici Carola	
ITA	ITA04260	F	GENTA MICOL	
ITA	ITA04520	F	Masoch Mariachiara	
ITA		F	PERINA CAMILLA	
ITA		F	Sbabo Angelica	
KOS	KOS2368	F	METOLLI EDINA	
KUW	KUW02220	F	ALSULTAN SALAMH	
NED	NED02464	F	YALCIN Samina	
PER	PER02703	F	Avila Anticona Johana Althea	
POL		F	Brzostowska Julia	
ROU	ROU2569	F	NASTAS PATRICIA	
SRB		F	Coso Anja	
SUI	SD59759	F	BOUTRACIT AÏCHA	
SVK	SVK2289	F	MRÁZOVÁ LUCIA	
TPE	TPE02416	F	CHAN HSIN-YU	
TPE	TPE02741	F	HSIAO YUN-CHEN	
TTO	TRI02131	F	LUE FATT ROSHELLE	
TUR	TUR03745	F	AKKAYA ZEYNEP	
TUR		F	Karadeniz Mihrap	
UKR		F	Pylypiuk Daria	

U21 Kumite Female -50 kg

Karate1 Youth League - Venice 2024, PALAZZO DEL TURISMO, Piazza Brescia 11, 30016 Lido di Jesolo VE, ITA

2024-12-04

Tatami
5 14:05

Pool
1/2

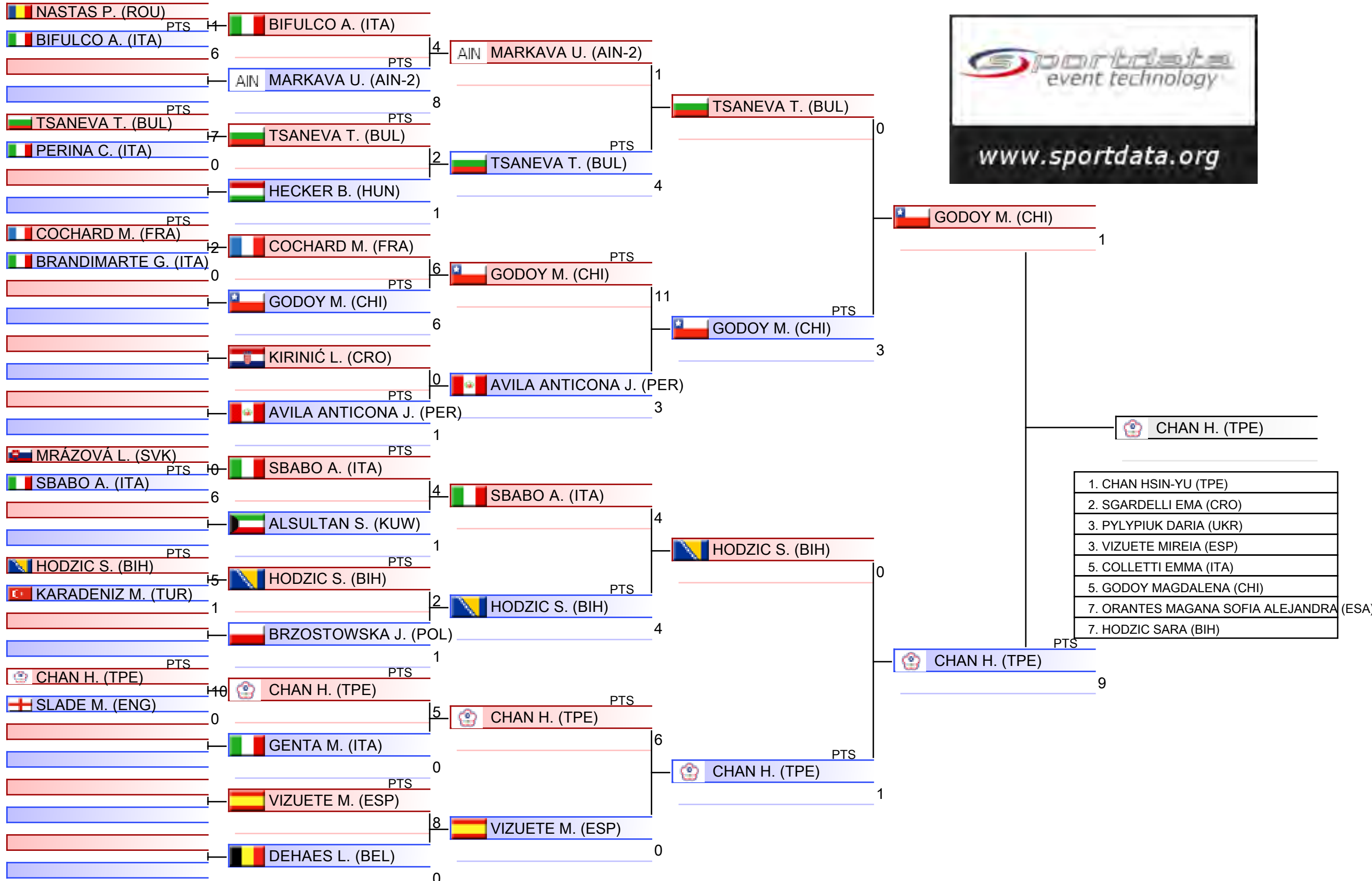

1.	CHAN HSIN-YU (TPE)
2.	SGARDELLI EMA (CRO)
3.	PYLYPIUK DARIA (UKR)
3.	VIZUETE MIREIA (ESP)
5.	COLLETTI EMMA (ITA)
5.	GODOY MAGDALENA (CHI)
7.	ORANTES MAGANA SOFIA ALEJANDRA (ESA)
7.	HODZIC SARA (BIH)

Pool winner-U21 Kumite Female -50 kg

Karate1 Youth League - Venice 2024, PALAZZO DEL TURISMO, Piazza Brescia 11, 30016 Lido di Jesolo VE, ITA

Tatami

Pool
1/1

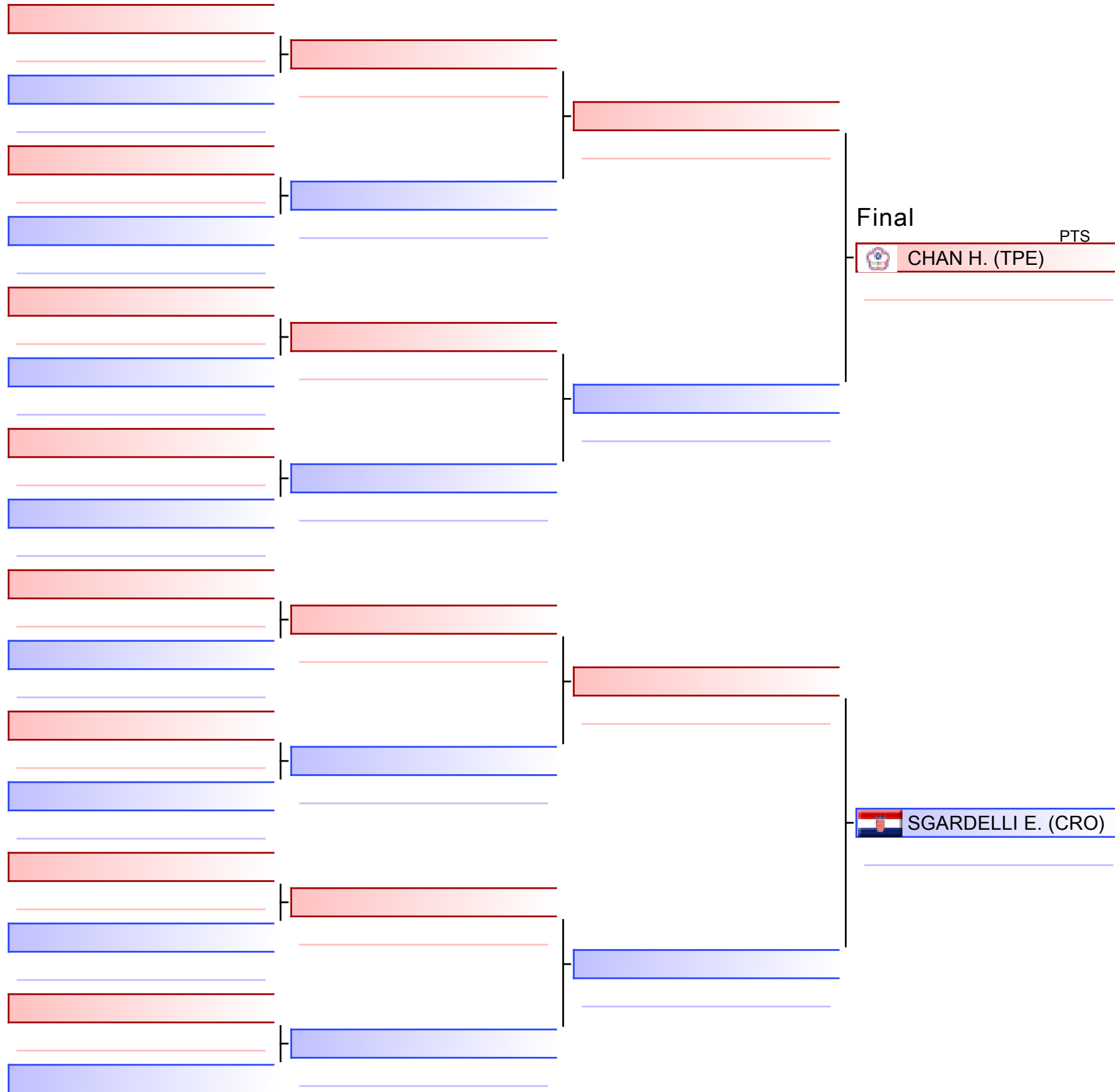

CHAN H. (TPE)

1. CHAN HSIN-YU (TPE)
2. SGARDELLI EMA (CRO)
3. PYLYPIUK DARIA (UKR)
3. VIZUETE MIREIA (ESP)
5. COLLETTI EMMA (ITA)
5. GODOY MAGDALENA (CHI)
7. ORANTES MAGANA SOFIA ALEJANDRA (ESA)
7. HODZIC SARA (BIH)

U21 Kumite Female -50 kg

Karate1 Youth League - Venice 2024

2024-12-04

Tatami
4 18:15

Pool
1,2

(c)sportdata GmbH & Co KG 2000-2024 (2024-12-08 20:16) v 10.2.0 build 1 (2024-11-20 00:58 CET) License: SDIL TVG (expire 2025-01-26)

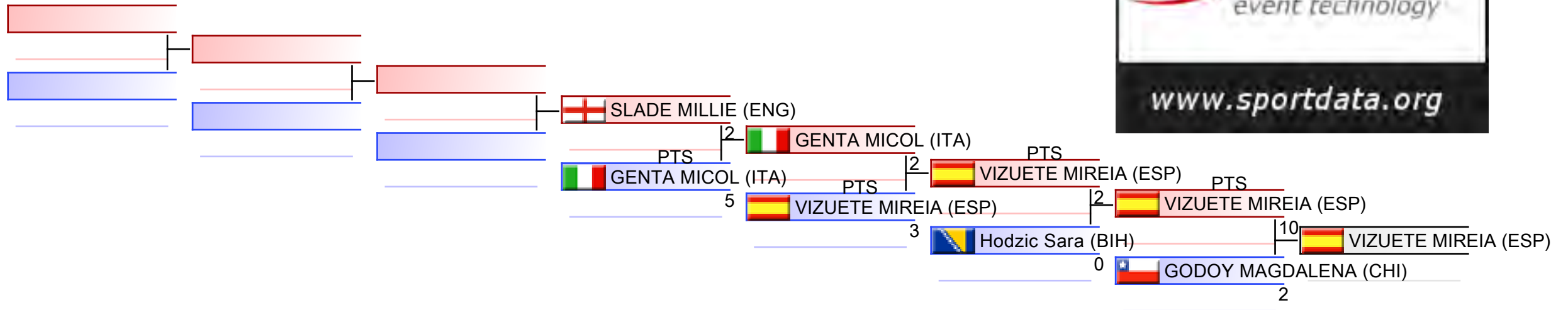

REPECHAGE: (1,2)

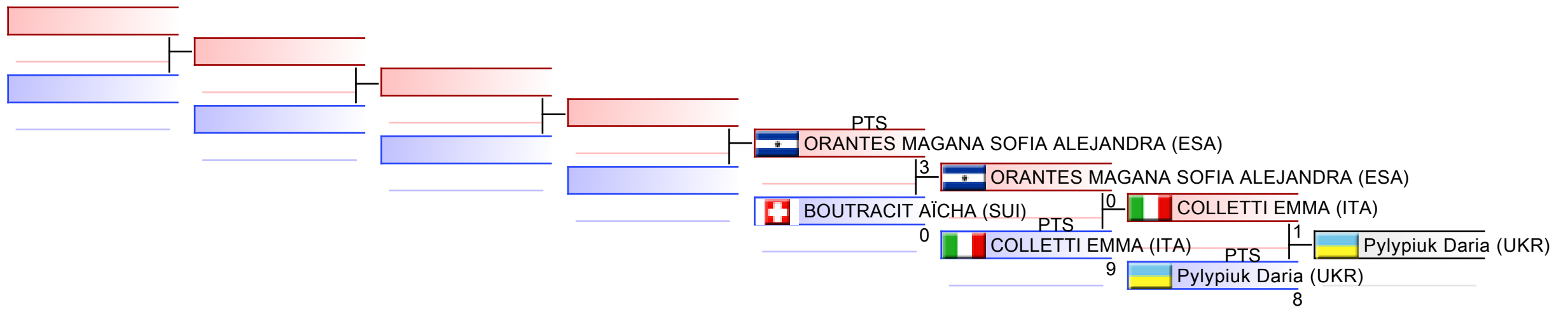



Karate1 Youth League - Venice 2024 - 2024-12-04



Official Results

U21 Kumite Female -50 kg (Entries: 43 Nations: 27)			
1	CHAN HSIN-YU		TPE - CHINESE TAIPEI
2	SGARDELLI EMA		CRO - CROATIA
3	PYLYPIUK DARIA		UKR - UKRAINE
3	VIZUETE MIREIA		ESP - SPAIN
5	COLLETTI EMMA		ITA - ITALY
5	GODOY MAGDALENA		CHI - CHILE
7	ORANTES MAGANA SOFIA ALEJANDRA		ESA - EL SALVADOR
7	HODZIC SARA		BIH - BOSNIA AND HERZEGOVINA
9	BOUTRACIT AICHA		SUI - SWITZERLAND
9	GENTA MICOL		ITA - ITALY
11	SLADE MILLIE		ENG - ENGLAND

U21 KUMITE FEMALE -55 KG



Karate1 Youth League - Venice 2024

ENTRIES BY WEIGHT CATEGORY



U21 Kumite Female -55 kg

As of 8 DEC 2024

Country Code	ID	Gender	Name	Seeding
AZE	AZE2224	F	KARIMOVA SUADA	
BEL	BEL02280	F	Ejja Iman	
BIH		F	Residbegovic Mubina	
BRA		F	Moura Alice	
CAN	CAN2303	F	REGLAR EMILY	
CHI	CHI02969	F	GATICA MORALES BELEN	
CRO	CRO03408	F	LUJIC ANA	
CRO	CRO2300	F	MAJSEC ISKRA	
CRO	CRO2968	F	Prga Patricija	
CRO		F	REZIĆ DORA	
ESP		F	Chaibi Ouiam	
ESP		F	CORONADO GIMENEZ SOFIA	
FRA	FRA03633	F	ABDESSELEM Silya	
FRA		F	Niang Maimouna	
FRA	FRA2644	F	TOUVREY JENNA	
FRA		F	Weiss Lisa	
GER		F	Telli Aylin	
GRE	GRE02320	F	XENOU LYDIA LAMPRINI	
HUN	HUN02666	F	Bene Bianka	
HUN	HUN02787	F	Molnár Virág	
ITA	ITA04478	F	Ariosto Myriam	
ITA	ITA03277	F	BOSCO ALICE	
ITA	SD61413	F	burzo francesca	
ITA		F	Dapas Vanessa	
ITA		F	Di domenico Chiara	
ITA	ITA2669	F	FABBRI GIORGIA	
ITA	ITA02957	F	GRONCHI MATILDE	
ITA		F	Nardi Chiara	
ITA		F	Ortu Rebecca	
ITA		F	Piantini Caterina	
ITA		F	zaccaro aisha	
KOS	KOS2348	F	FONIQI ANILA	
LUX	LUX02426	F	JADIN LANA	
MDA	MDA02342	F	BEREZOVSCAIA ELENA	
POL	POL08881	F	DRONCHANKA KSENIYA	
POL	POL3409	F	KAWICKA WERONIKA	
ROU	ROU03098	F	ANDREI LORELLEY ANISIA	
ROU	ROU2191	F	STOIAN ALEXANDRA MIHAELA	
ROU	ROU02712	F	STOROBANEANU EMILIA	
SVK	SVK02345	F	Kvasnicova Nina	
SVK	SVK02627	F	Malá Liliana	
TPE	TPE02745	F	TIEN HSIN-ERH	

U21 Kumite Female -55 kg

Karate1 Youth League - Venice 2024, PALAZZO DEL TURISMO, Piazza Brescia 11, 30016 Lido di Jesolo VE, ITA

2024-12-04

Tatami
7 14:05

Pool
1/2

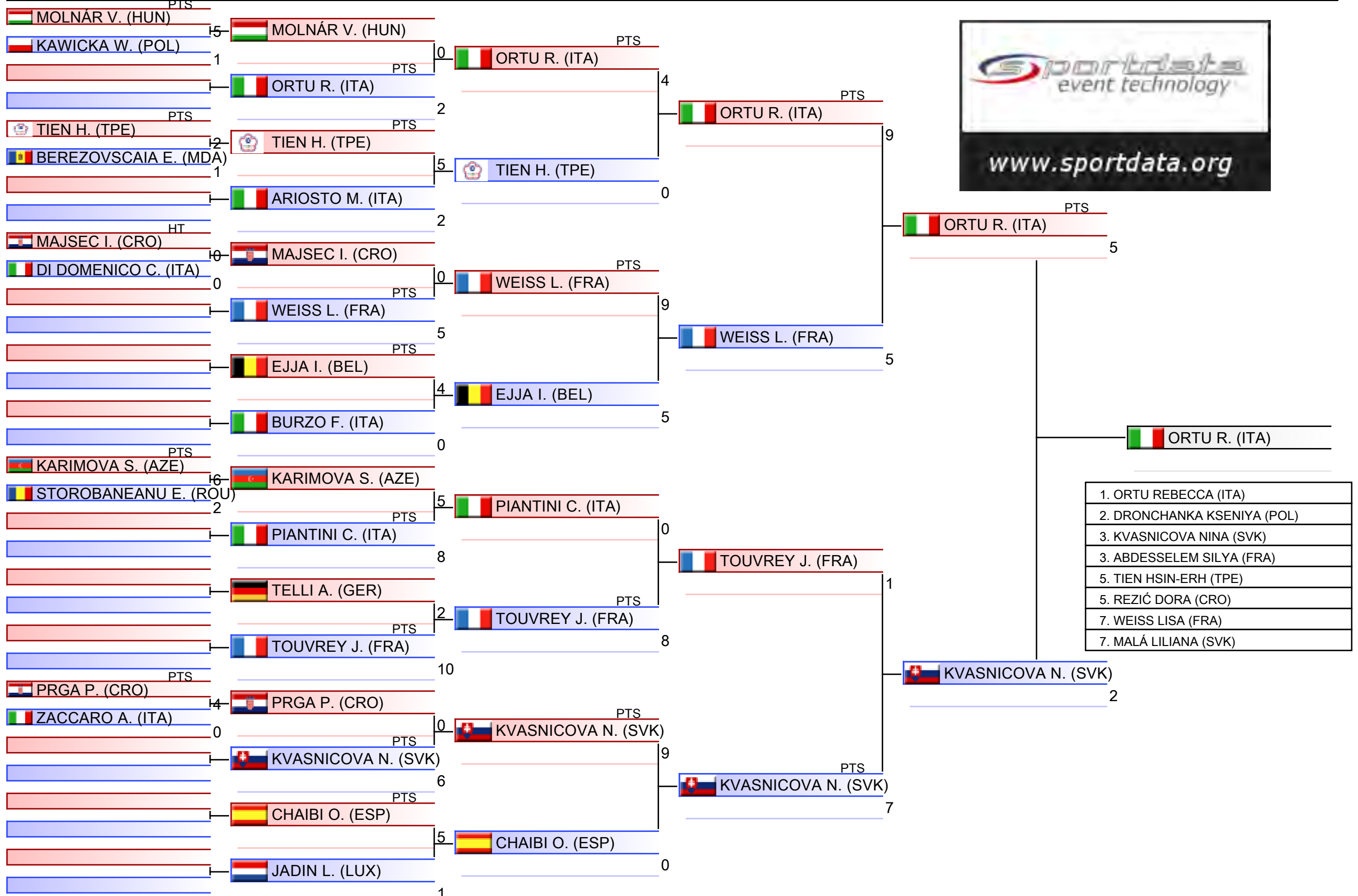

U21 Kumite Female -55 kg

Karate1 Youth League - Venice 2024, PALAZZO DEL TURISMO, Piazza Brescia 11, 30016 Lido di Jesolo VE, ITA

2024-12-04

Tatami
8 14:05

Pool
2/2

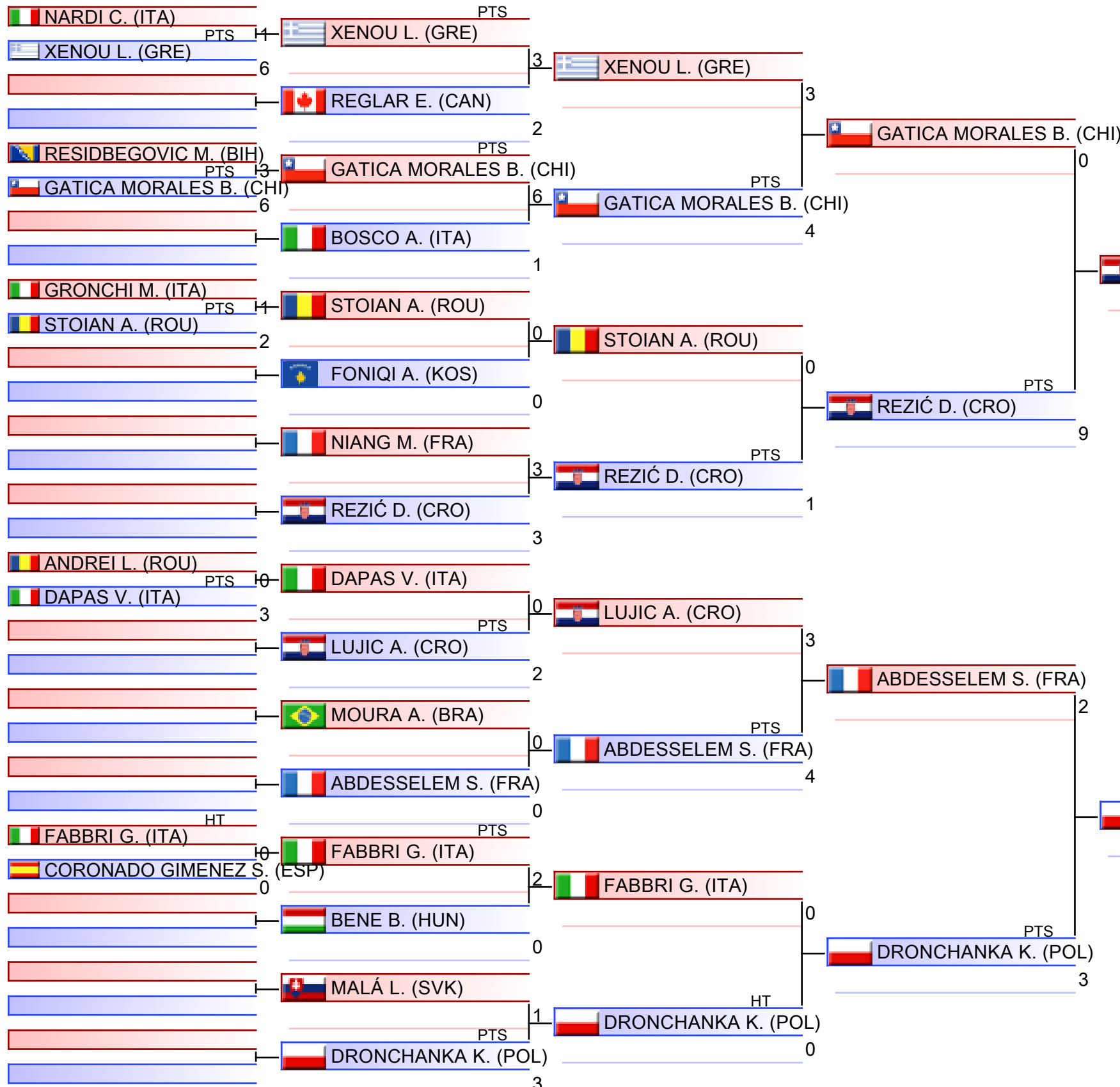

1. ORTU REBECCA (ITA)
2. DRONCHANKA KSENIYA (POL)
3. KVASNICOVA NINA (SVK)
3. ABDESSELEM SILYA (FRA)
5. TIEN HSIN-ERH (TPE)
5. REZIĆ DORA (CRO)
7. WEISS LISA (FRA)
7. MALÁ LILIANA (SVK)

Pool winner-U21 Kumite Female -55 kg

Karate1 Youth League - Venice 2024, PALAZZO DEL TURISMO, Piazza Brescia 11, 30016 Lido di Jesolo VE, ITA

Tatami

Pool

1/1

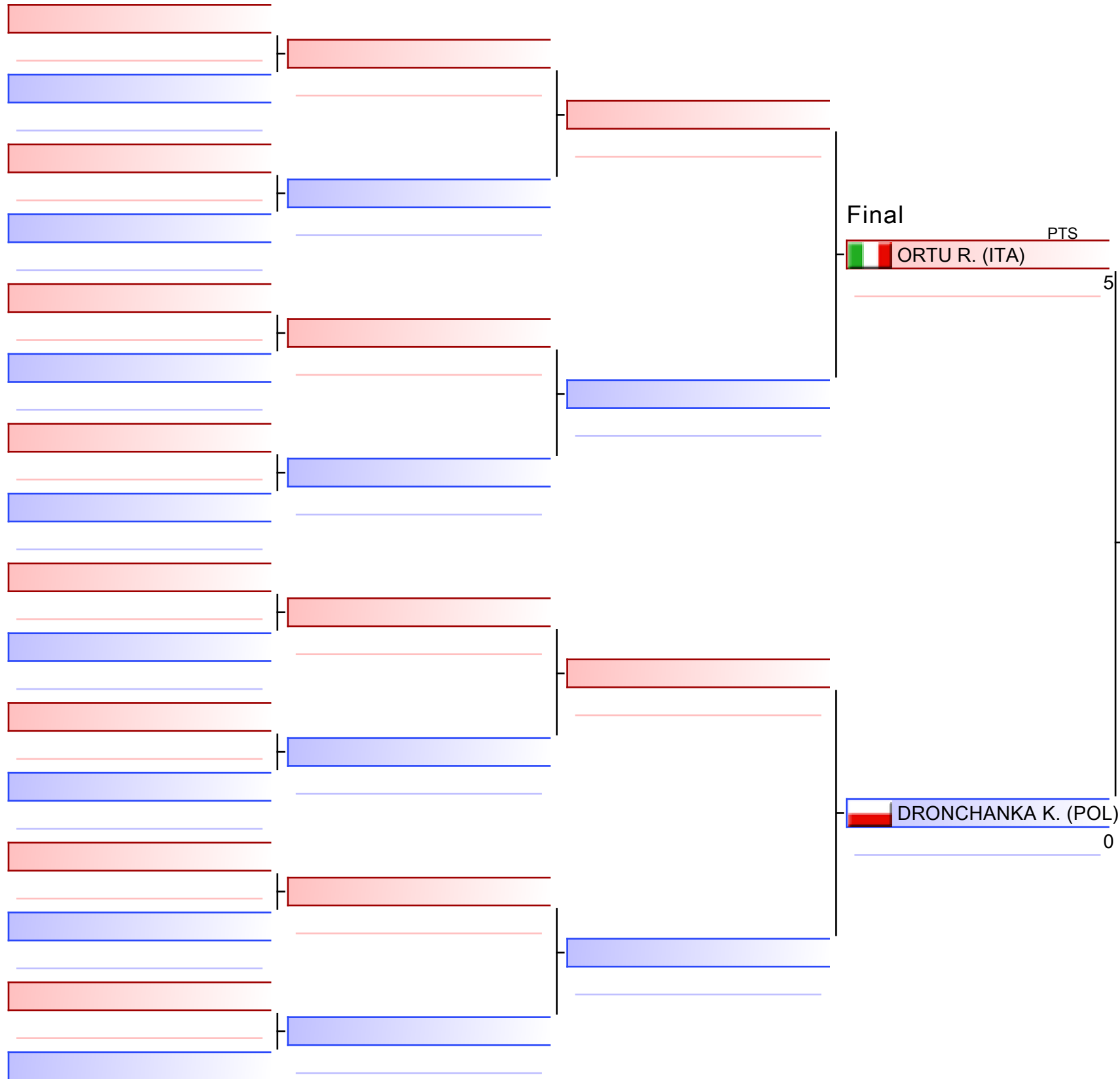

Final

PTS

ORTU R. (ITA) 5

ORTU R. (ITA)

DRONCHANKA K. (POL) 0

1. ORTU REBECCA (ITA)
2. DRONCHANKA KSENIYA (POL)
3. KVASNICOVA NINA (SVK)
3. ABDESSELEM SILYA (FRA)
5. TIEN HSIN-ERH (TPE)
5. REZIĆ DORA (CRO)
7. WEISS LISA (FRA)
7. MALÁ LILIANA (SVK)

U21 Kumite Female -55 kg

Karate1 Youth League - Venice 2024

2024-12-04

Tatami
7 18:40

Pool
1,2

(c)sportdata GmbH & Co KG 2000-2024 (2024-12-08 20:16) v 10.2.0 build 1 (2024-11-20 00:58 CET) License: SDIL TVG (expire 2025-01-26)

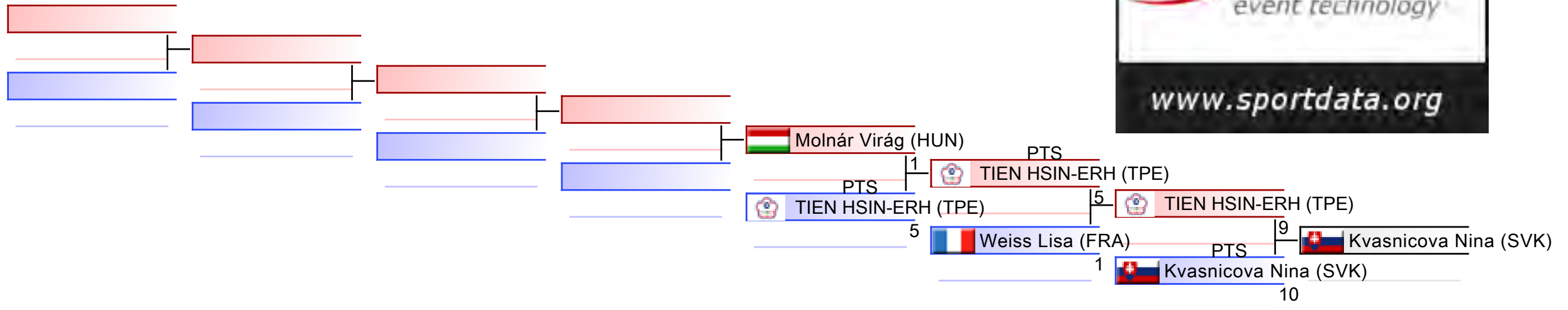

REPECHAGE: (1,2)

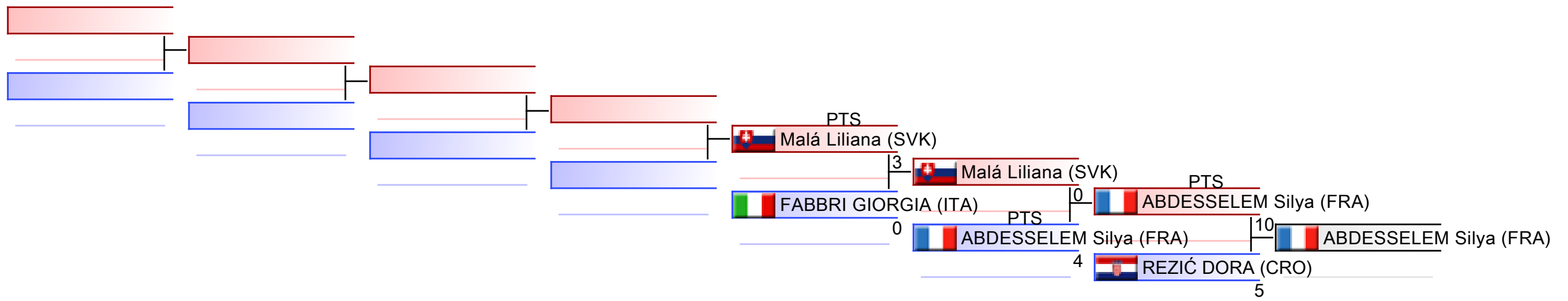



Karate1 Youth League - Venice 2024 - 2024-12-04



Official Results

U21 Kumite Female -55 kg (Entries: 42 Nations: 20)			
1	ORTU REBECCA		ITA - ITALY
2	DRONCHANKA KSENIYA		POL - POLAND
3	KVASNICOVA NINA		SVK - SLOVAKIA
3	ABDESSELEM SILYA		FRA - FRANCE
5	TIEN HSIN-ERH		TPE - CHINESE TAIPEI
5	REZIĆ DORA		CRO - CROATIA
7	WEISS LISA		FRA - FRANCE
7	MALÁ LILIANA		SVK - SLOVAKIA
9	MOLNÁR VIRÁG		HUN - HUNGARY
9	FABBRI GIORGIA		ITA - ITALY

U21 KUMITE FEMALE -61 KG



Karate1 Youth League - Venice 2024

ENTRIES BY WEIGHT CATEGORY



U21 Kumite Female -61 kg

As of 8 DEC 2024

Country Code	ID	Gender	Name	Seeding
AUT	AUT02677	F	Skrijelj Sara	
AZE	AZE02736	F	NAKONECHNA OKSANA	
BEL	BEL02332	F	Bougrine Amel	
BIH	BIH2818	F	Baraković Medina	
BIH		F	Jakšić Aleksandra	
BIH	BIH2110	F	SIPOVIC EMINA	
BUL	BUL02827	F	PETKOVA MARIELA	
CRO		F	Benić Sara	
CRO	CRO2827	F	Beslija Nika	
CRO	CRO2627	F	Cacko Mia	
CRO	CRO2451	F	SNAJDER DARIJA	
CRO	CRO03586	F	Vajda Magdalena	
ENG	ENG02963	F	Bailey Isabelle	
FRA	FRA02778	F	YVON Sydney	
GER		F	Keller Kristina	
GER	GER03292	F	Rabhi Douaa	
GER	GER03258	F	Semenenko Anastasiia	
GER	GER2585	F	Tsoucalas Charleene	
GRE	GRE003889	F	ROUVINETI ELENI	
IRI		F	Alizadehchamazketi Paria	
IRL	IRL02801	F	O BRIEN SADHBH	
ITA		F	Amarante Francesca	
ITA		F	Campobasso Aurora	
ITA	ITA04266	F	Cornoló Giada	
ITA	ITA03043	F	Deste Federica	
ITA	ITA03322	F	DON ALICE	
ITA		F	DUCA GIORGIA	
ITA	ITA03867	F	Guazzaroni Alessandra	
ITA		F	Laiolo Serena	
ITA	ITA03323	F	MAFFIZZOLI GAIA	
ITA	ITA03806	F	MARTURANO IRENE	
ITA	ITA03552	F	MASSARI GIORGIA	
ITA	ITA03035	F	SCHICCHI ALESSANDRA	
KOS	KOS02728	F	ISLAMI DINETA	
LAT		F	Girvica Beata	
MKD		F	Micovska Jovana	
NED	NED02396	F	Kakiay Ashley	
POL	POL07767	F	Criou Eva	
POL	POL3411	F	KAWICKA DOMINIKA	
POL	POL05855	F	KOT ALEKSANDRA	
POL	POL06896	F	Lewandowska Katarzyna	
POL	POL2636	F	Żurawska Antonina	
POR		F	Lopes Joana	
POR	POR02714	F	Lourenço Daniela	
PYF		F	CAVANIE KENLY	



Karate1 Youth League - Venice 2024
ENTRIES BY WEIGHT CATEGORY



U21 Kumite Female -61 kg
As of 8 DEC 2024

Country Code	ID	Gender	Name	Seeding
ROU	ROU03095	F	IVASCU LARISA ADRIANA	
ROU	ROU2367	F	MANICA ANTONIA	
SUI	SUI02240	F	Bosshard Lea	
SUI	SUI02417	F	Burri Liliane	
SUI	SUI02280	F	Duperrex Oksana	
SUI	SUI02329	F	Thomaidis Keara	
SVK		F	Dabin Juliette	
SVK		F	Vaczy Anna	
SWE	SWE003235	F	Wohlgemuth Naiya	
TPE	TPE02742	F	PAO YU-HSUN	

U21 Kumite Female -61 kg

Karate1 Youth League - Venice 2024, PALAZZO DEL TURISMO, Piazza Brescia 11, 30016 Lido di Jesolo VE, ITA

2024-12-04

Tatami
1 16:45

Pool
1/4

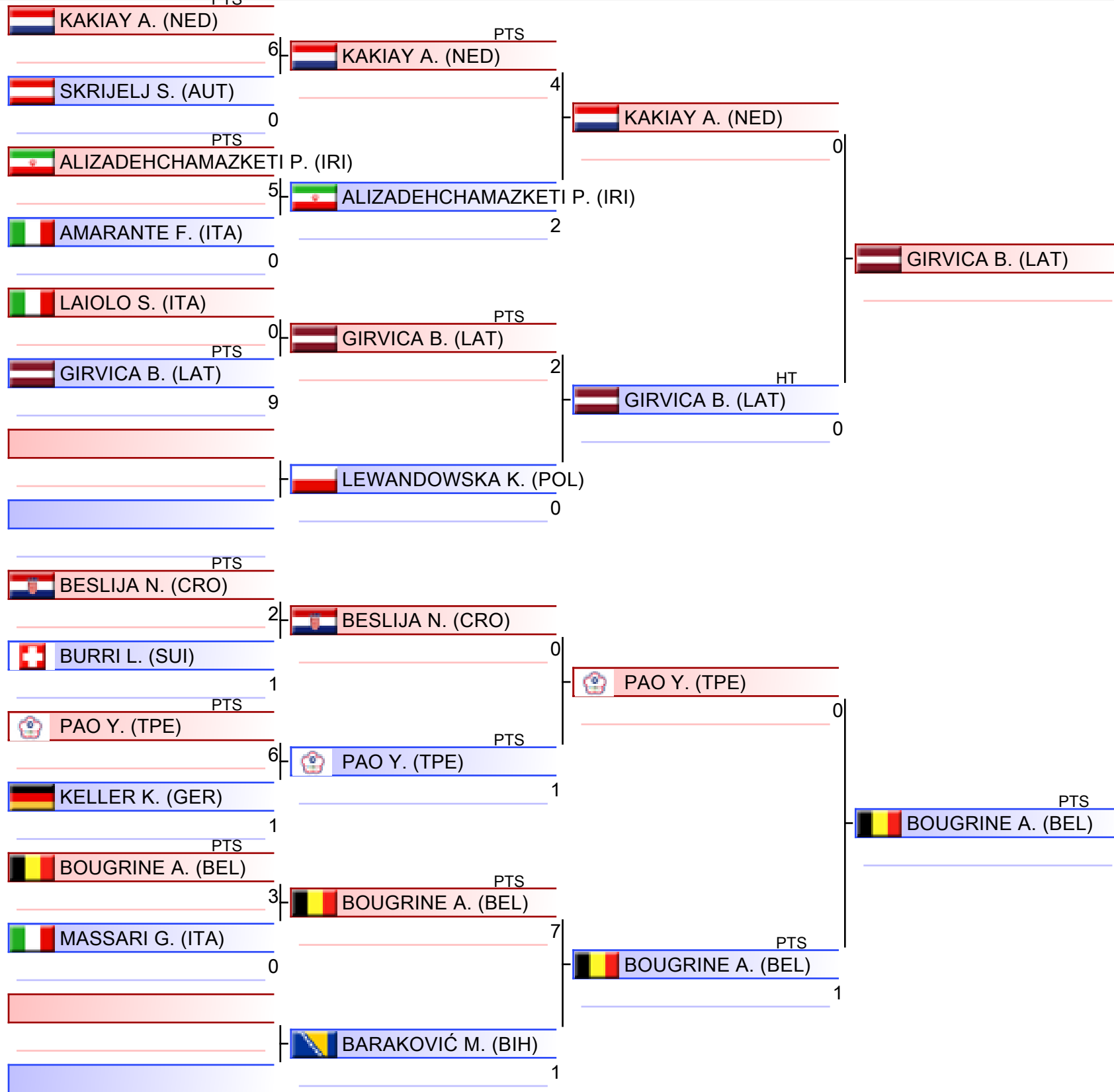

BOUGRINE A. (BEL)

1. YVON SYDNEY (FRA)
2. VACZY ANNA (SVK)
3. BOUGRINE AMEL (BEL)
3. SIPOVIC EMINA (BIH)
5. MARTURANO IRENE (ITA)
5. RABHI DOUAA (GER)
7. CAMPOBASSO AURORA (ITA)
7. NAKONECHNA OKSANA (AZE)

U21 Kumite Female -61 kg

Karate1 Youth League - Venice 2024, PALAZZO DEL TURISMO, Piazza Brescia 11, 30016 Lido di Jesolo VE, ITA

2024-12-04

Tatami
2 16:45

Pool
2/4

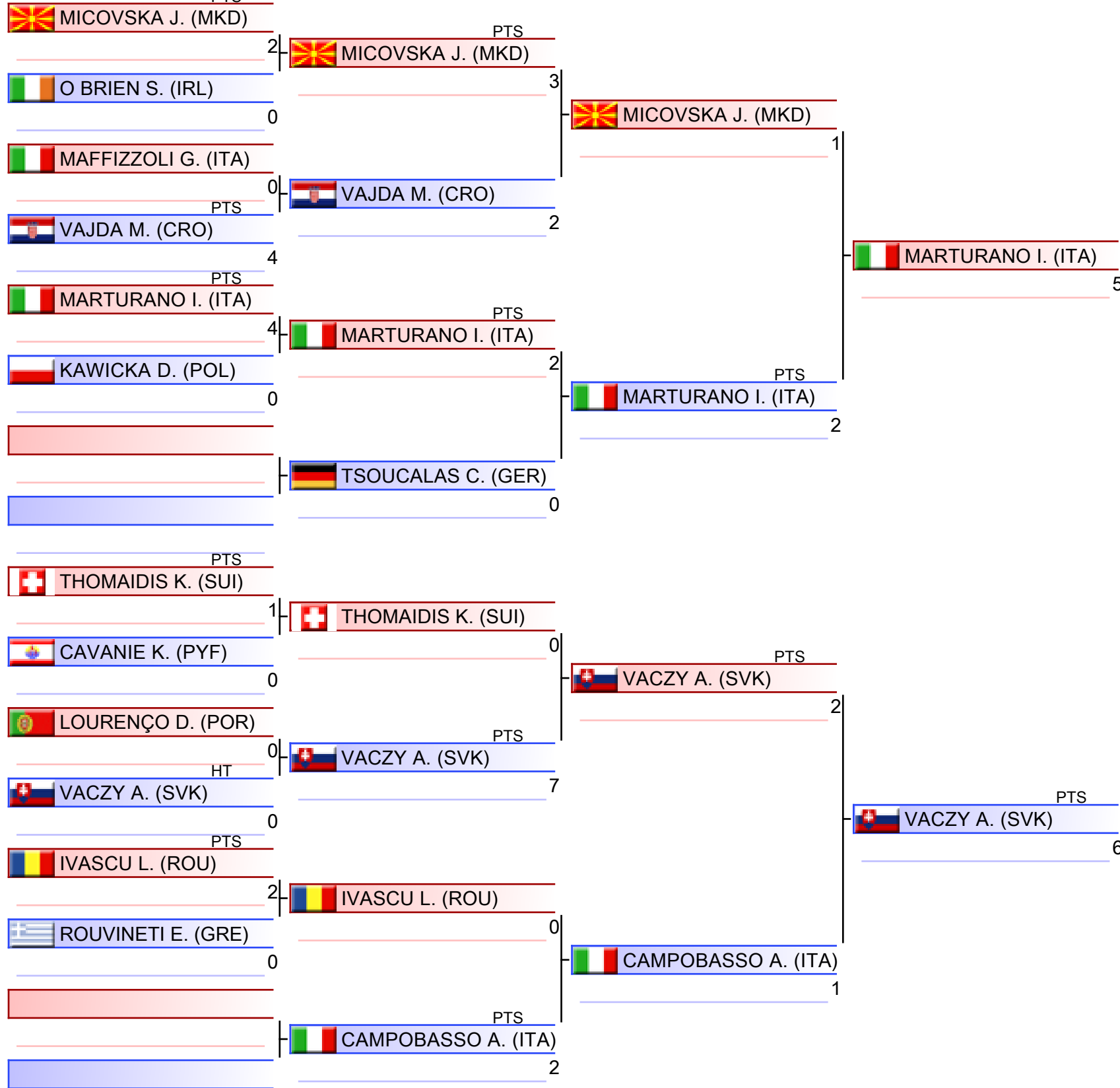

1. YVON SYDNEY (FRA)
2. VACZY ANNA (SVK)
3. BOUGRINE AMEL (BEL)
3. SIPOVIC EMINA (BIH)
5. MARTURANO IRENE (ITA)
5. RABHI DOUAA (GER)
7. CAMPOBASSO AURORA (ITA)
7. NAKONECHNA OKSANA (AZE)

U21 Kumite Female -61 kg

Karate1 Youth League - Venice 2024, PALAZZO DEL TURISMO, Piazza Brescia 11, 30016 Lido di Jesolo VE, ITA

2024-12-04

Tatami
3 16:45

Pool
3/4

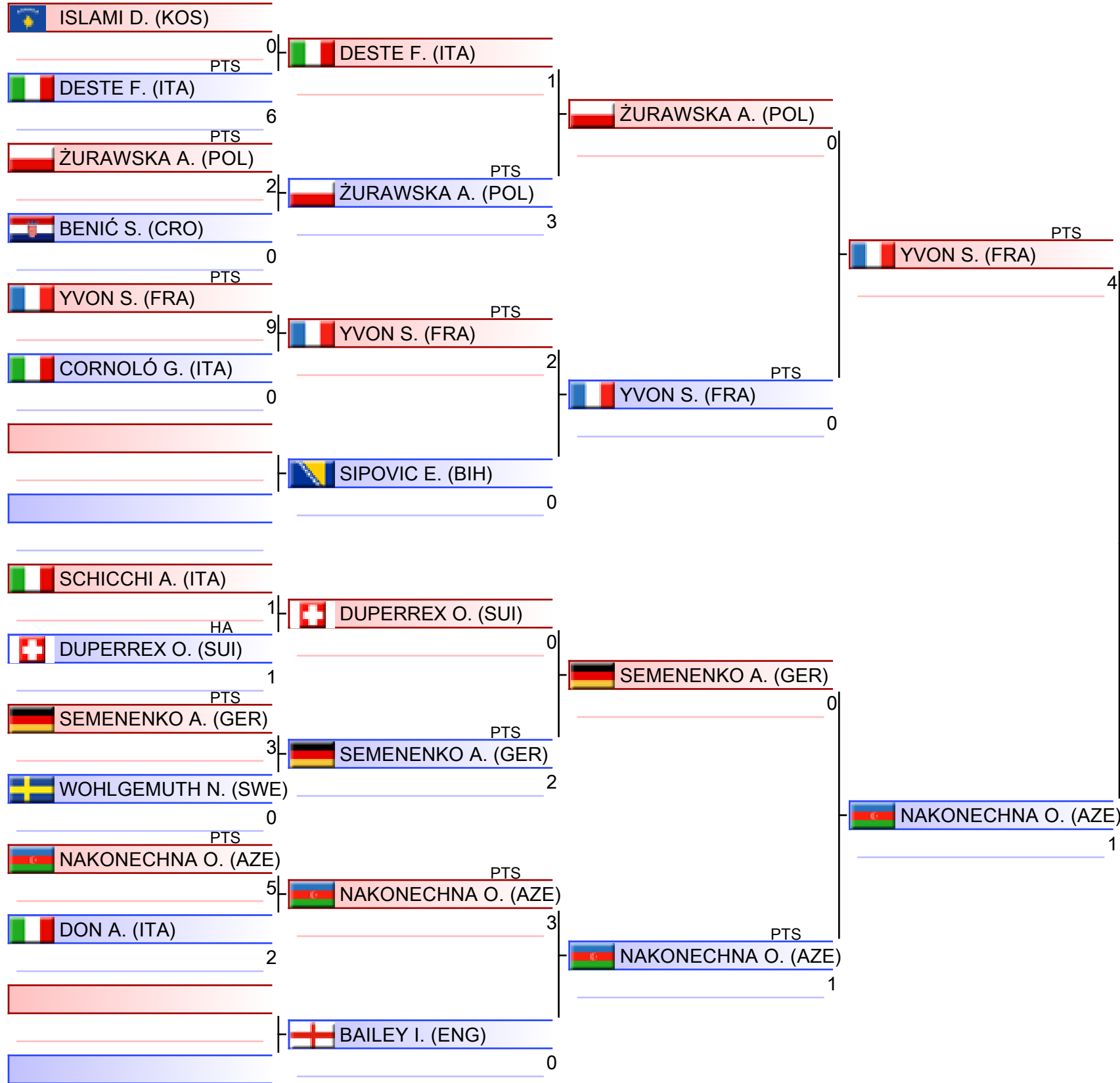

1. YVON SYDNEY (FRA)
2. VACZY ANNA (SVK)
3. BOUGRINE AMEL (BEL)
3. SIPOVIC EMINA (BIH)
5. MARTURANO IRENE (ITA)
5. RABHI DOUAA (GER)
7. CAMPOBASSO AURORA (ITA)
7. NAKONECHNA OKSANA (AZE)

U21 Kumite Female -61 kg

Karate1 Youth League - Venice 2024, PALAZZO DEL TURISMO, Piazza Brescia 11, 30016 Lido di Jesolo VE, ITA

2024-12-04

Tatami
4 16:45

Pool
4/4

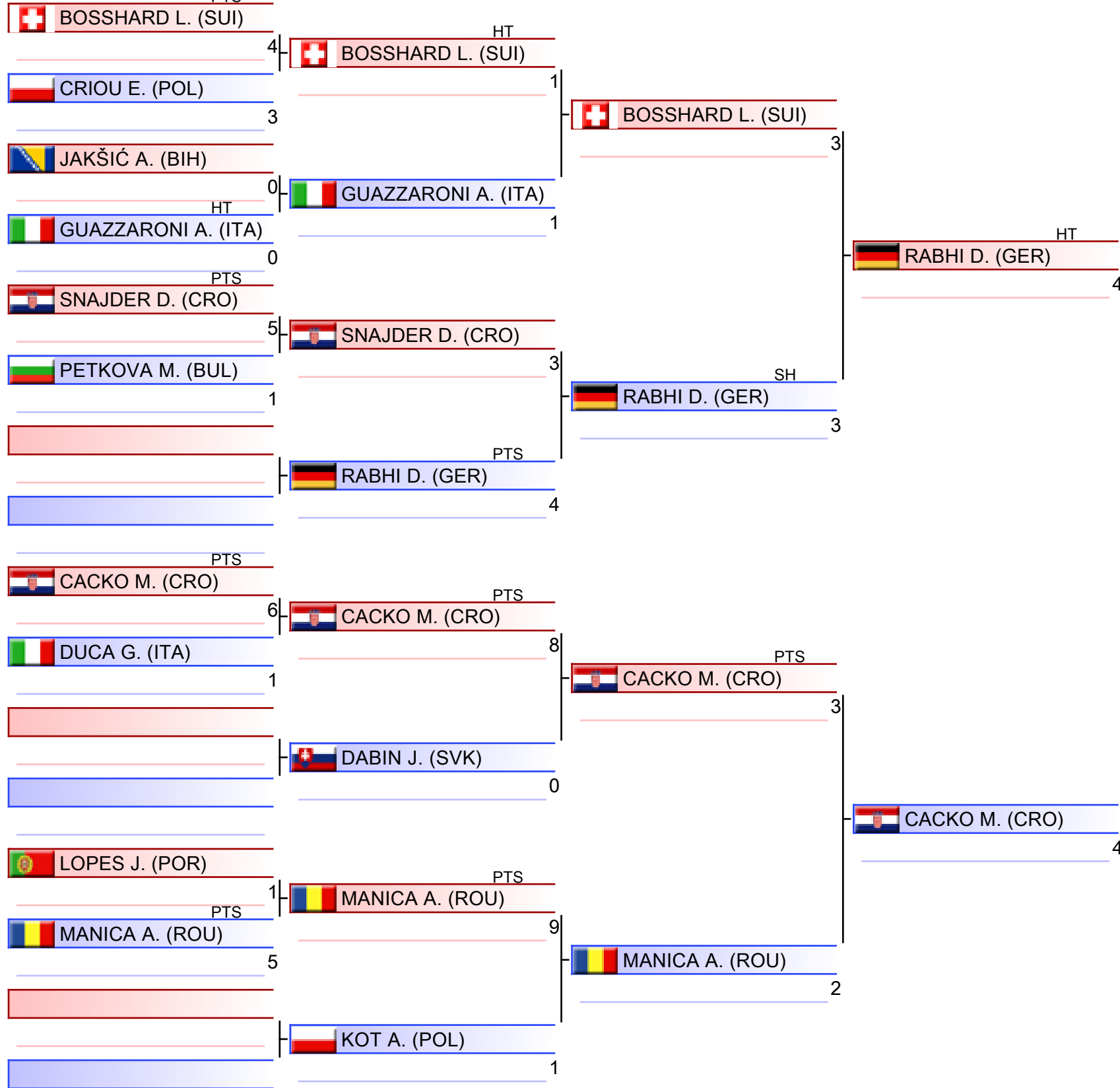

1. YVON SYDNEY (FRA)
2. VACZY ANNA (SVK)
3. BOUGRINE AMEL (BEL)
3. SIPOVIC EMINA (BIH)
5. MARTURANO IRENE (ITA)
5. RABHI DOUAA (GER)
7. CAMPOBASSO AURORA (ITA)
7. NAKONECHNA OKSANA (AZE)

Pool winner-U21 Kumite Female -61 kg

Karate1 Youth League - Venice 2024, PALAZZO DEL TURISMO, Piazza Brescia 11, 30016 Lido di Jesolo VE, ITA

2024-12-04

Tatami
1 18:05

Pool
1/1

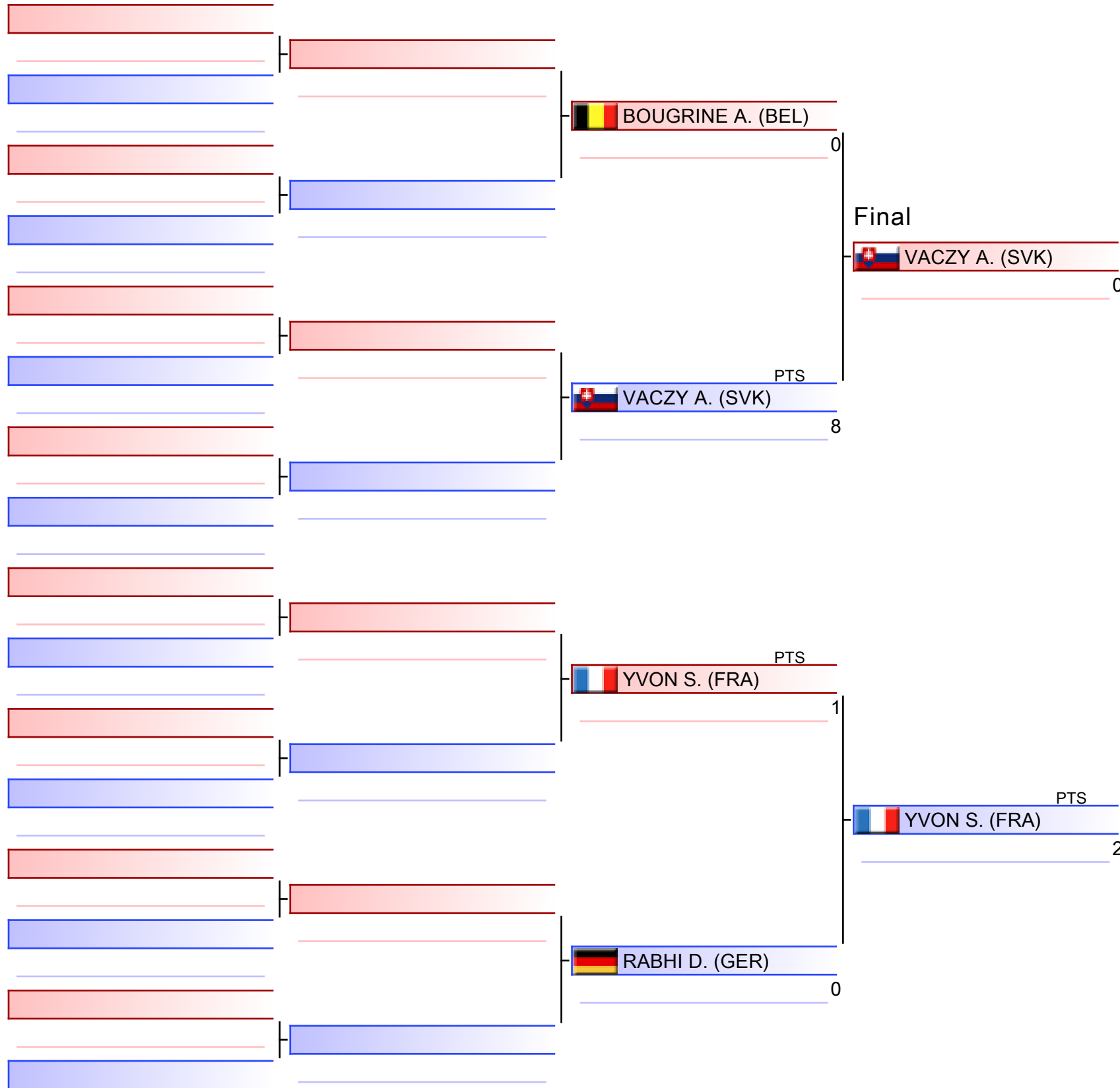

YVON S. (FRA)

1. YVON SYDNEY (FRA)
2. VACZY ANNA (SVK)
3. BOUGRINE AMEL (BEL)
3. SIPOVIC EMINA (BIH)
5. MARTURANO IRENE (ITA)
5. RABHI DOUAA (GER)
7. CAMPOBASSO AURORA (ITA)
7. NAKONECHNA OKSANA (AZE)

U21 Kumite Female -61 kg

Karate1 Youth League - Venice 2024

2024-12-04

Tatami

5 18:40

Pool

1,2,3,4

(c)sportdata GmbH & Co KG 2000-2024 (2024-12-08 20:16) v 10.2.0 build 1 (2024-11-20 00:58 CET) License: SDIL TVG (expire 2025-01-26)

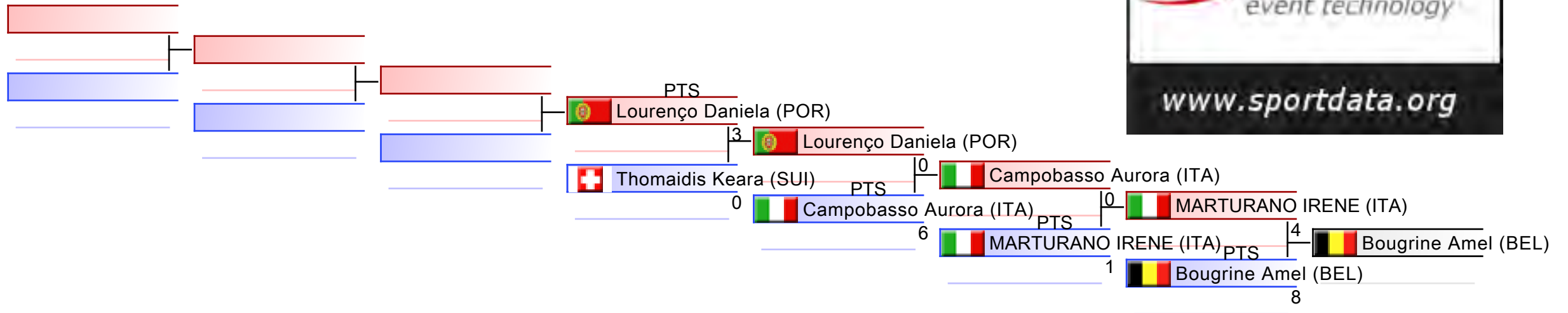

REPECHAGE: (1,2,3,4)

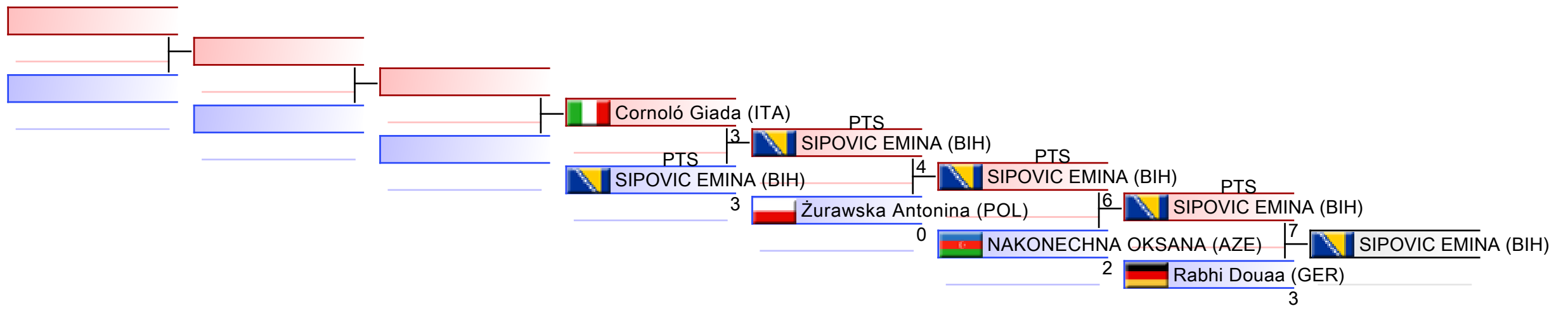



Karate1 Youth League - Venice 2024 - 2024-12-04



Official Results

U21 Kumite Female -61 kg (Entries: 55 Nations: 25)			
1	YVON SYDNEY		FRA - FRANCE
2	VACZY ANNA		SVK - SLOVAKIA
3	BOUGRINE AMEL		BEL - BELGIUM
3	SIPOVIC EMINA		BIH - BOSNIA AND HERZEGOVINA
5	MARTURANO IRENE		ITA - ITALY
5	RABHI DOUAA		GER - GERMANY
7	CAMPOBASSO AURORA		ITA - ITALY
7	NAKONECHNA OKSANA		AZE - AZERBAIJAN
9	LOURENÇO DANIELA		POR - PORTUGAL
9	ŻURAWSKA ANTONINA		POL - POLAND
11	THOMASIDIS KEARA		SUI - SWITZERLAND
11	CORNOLÓ GIADA		ITA - ITALY

U21 KUMITE FEMALE -68 KG



Karate1 Youth League - Venice 2024

ENTRIES BY WEIGHT CATEGORY



U21 Kumite Female -68 kg

As of 8 DEC 2024

Country Code	ID	Gender	Name	Seeding
BEL	BEL02333	F	Bougrine Amina	
BEL	SD59682	F	Vervoort Tess	
BIH		F	Krnetić Jana	
BIH		F	Reiz Jasmina	
CRO	CRO2216	F	Ivakovic Lolita Lana	
CRO		F	Krešić Tea	
CRO	CRO03373	F	Lovric Mirta	
CRO		F	MANDIĆ MARIJA	
CRO		F	Ross Adriana	
CZE	CZE02253	F	TINAVSKA EMA	
ENG	ENG2387	F	Marshall Rebecca	
ENG	ENG02901	F	Wyman Jessica-Lee	
ESP		F	Andres Paula	
ESP		F	BEJARANO VILLANUEVA MIREIA	
ESP		F	MACIA RAQUEL	
FIN	FIN2130	F	Koponen Kiia	
FIN		F	saadaoui Sonya	
FRA		F	Barbarin Johanne	
FRA		F	mous Sajia	
FRA		F	Ozgun Pelin	
FRA	FRA03306	F	Porquet Faith	
GER	GER03284	F	Lindstädt Marlene	
GER	GER02746	F	Riedel Hannah	
HUN	HUN02781	F	Ádám Alexandra	
HUN	HUN2393	F	Loyal Emma Lili	
ITA		F	Agostinelli Ludovica	
ITA		F	Buono Marta	
ITA		F	CUZZOLINO MARIACONCETTA	
ITA		F	Dalle Fusine Maria Carlotta	
ITA	ITA04269	F	DESIDERIO ANNA PIA	
ITA		F	Di Maria Susanna	
ITA		F	GIORDANI Paola	
ITA		F	Guerrini Alice	
ITA		F	MIKOL MININNI	
ITA	ITA03883	F	Portoghese Morena	
ITA	ITA02892	F	Simonini Valentina	
ITA		F	VERRIA Martina	
KAZ	KAZ02650	F	Sagynbek Laura	
MLT	MLT2112	F	CUNNINGHAM AMY	
POL	POL3284	F	CICHOSZEWSKA NATASZA	
POR		F	Pinto Verónica	
ROU	ROU2461	F	MANICA BRIANA	
SLO	SLO02682	F	MUZIK TASA	
SVK		F	Kalamárová Alexandra	
SWE		F	Zarei Lara	



Karate1 Youth League - Venice 2024
ENTRIES BY WEIGHT CATEGORY



U21 Kumite Female -68 kg
As of 8 DEC 2024

Country Code	ID	Gender	Name	Seeding
TUN	TUN02803	F	Ettaleb Meriame	
UKR		F	Barykina Daryna	
UKR	UKR02682	F	Fohlinska Vira	

U21 Kumite Female -68 kg

Karate1 Youth League - Venice 2024, PALAZZO DEL TURISMO, Piazza Brescia 11, 30016 Lido di Jesolo VE, ITA

2024-12-04

Tatami
5 16:15

Pool
1/2

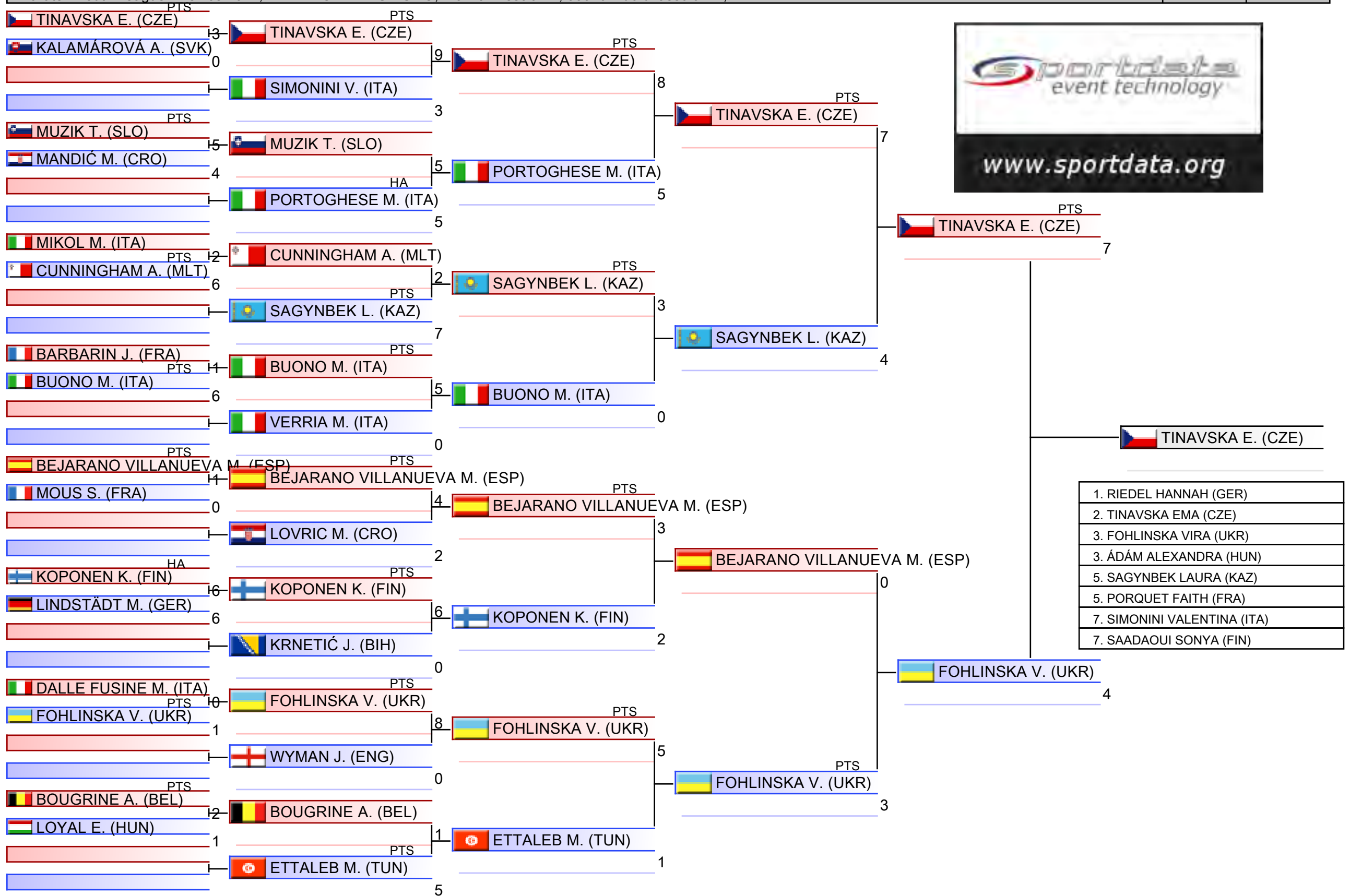

U21 Kumite Female -68 kg

Karate1 Youth League - Venice 2024, PALAZZO DEL TURISMO, Piazza Brescia 11, 30016 Lido di Jesolo VE, ITA

2024-12-04

Tatami
6 16:15

Pool
2/2

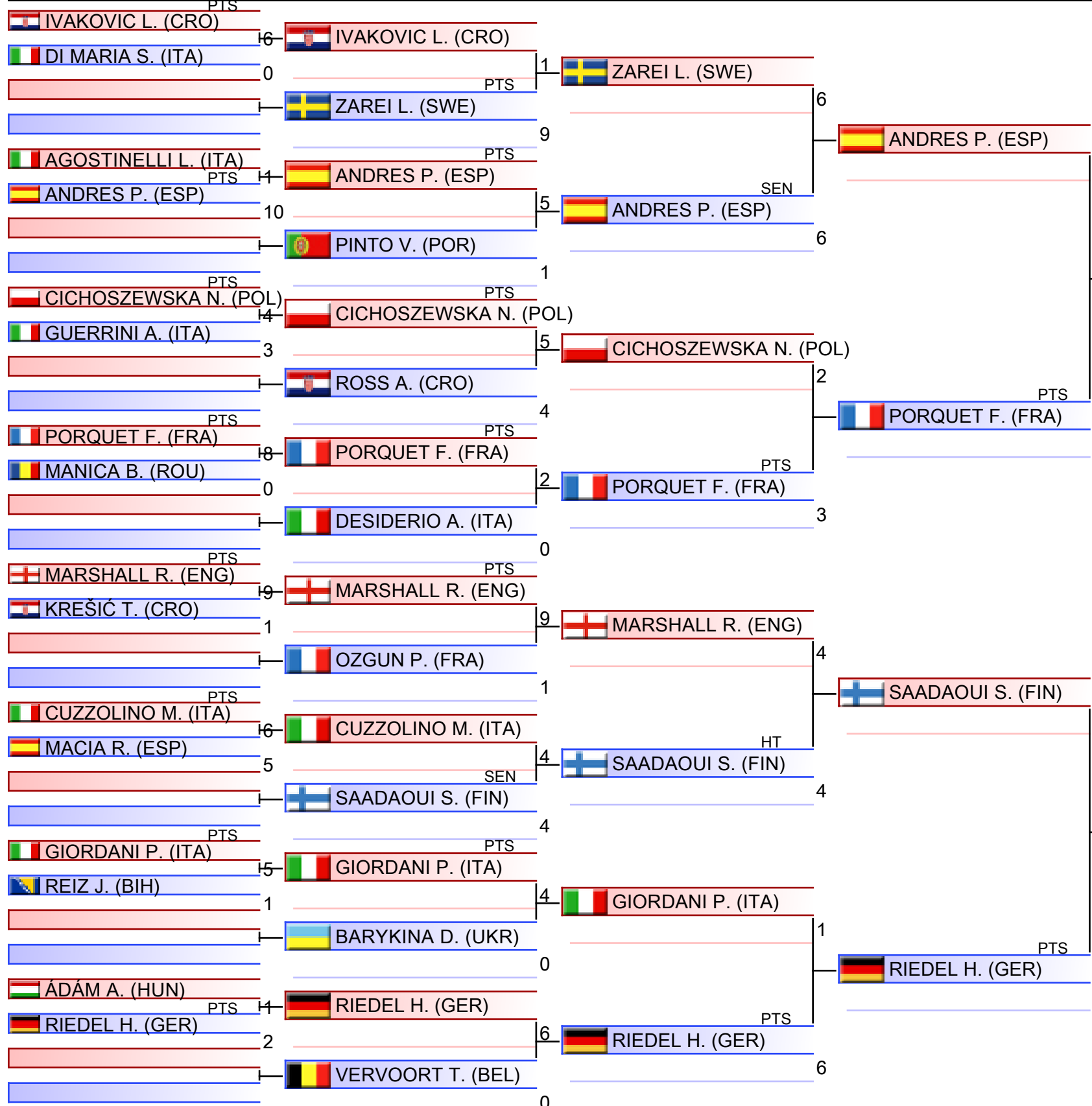

1. RIEDEL HANNAH (GER)
2. TINAVSKA EMA (CZE)
3. FOHLINSKA VIRA (UKR)
3. ÁDÁM ALEXANDRA (HUN)
5. SAGYNBEK LAURA (KAZ)
5. PORQUET FAITH (FRA)
7. SIMONINI VALENTINA (ITA)
7. SAADAOUI SONYA (FIN)

Pool winner-U21 Kumite Female -68 kg

Karate1 Youth League - Venice 2024, PALAZZO DEL TURISMO, Piazza Brescia 11, 30016 Lido di Jesolo VE, ITA

Tatami

Pool

1/1

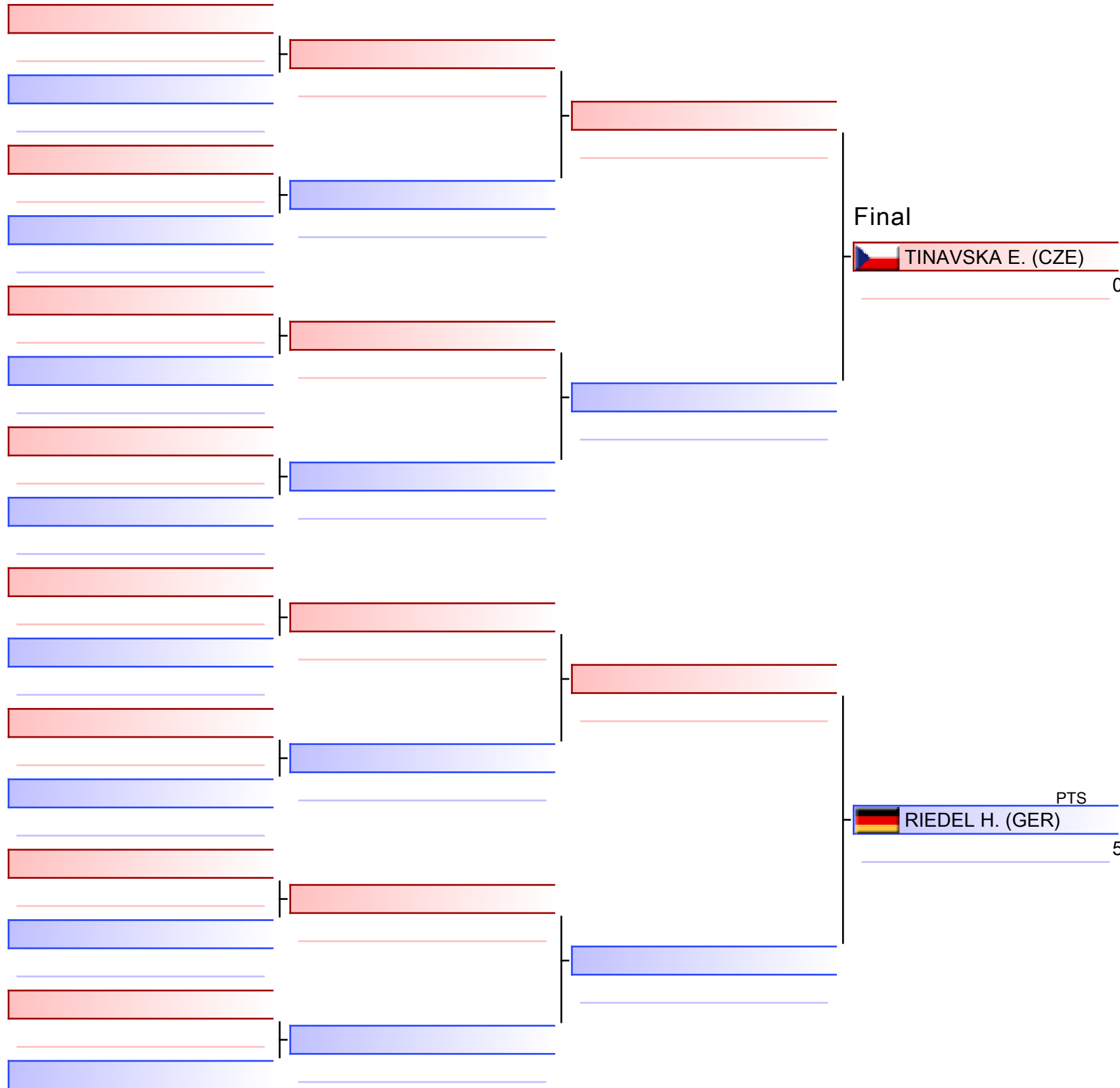

RIEDEL H. (GER)

Final

TINAVSKA E. (CZE)

0

PTS

RIEDEL H. (GER)

5

1. RIEDEL HANNAH (GER)
2. TINAVSKA EMA (CZE)
3. FOHLINSKA VIRA (UKR)
3. ÁDÁM ALEXANDRA (HUN)
5. SAGYNBEK LAURA (KAZ)
5. PORQUET FAITH (FRA)
7. SIMONINI VALENTINA (ITA)
7. SAADAQUI SONYA (FIN)

U21 Kumite Female -68 kg

Karate1 Youth League - Venice 2024

2024-12-04

Tatami
6 18:40

Pool
2,1

(c)sportdata GmbH & Co KG 2000-2024 (2024-12-08 20:16) v 10.2.0 build 1 (2024-11-20 00:58 CET) License: SDIL TVG (expire 2025-01-26)

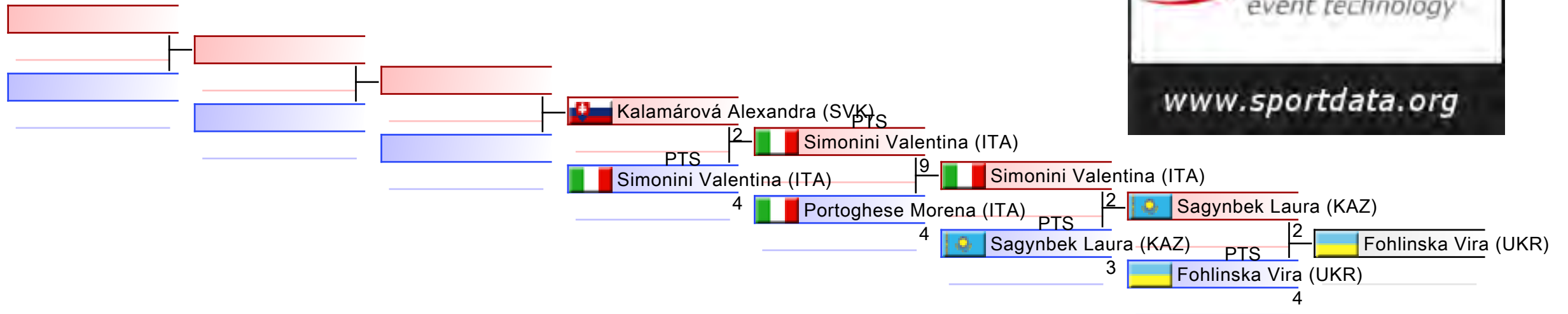

REPECHAGE: (2,1)

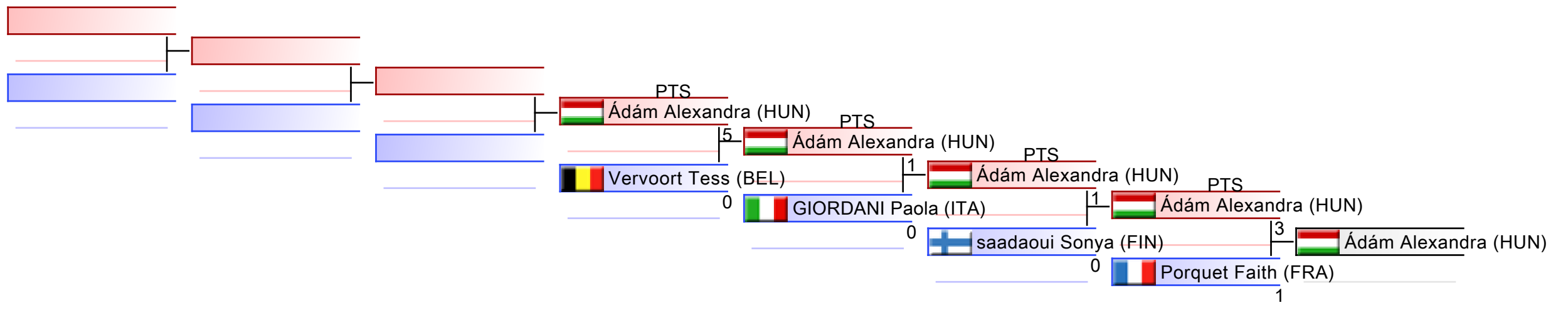



Karate1 Youth League - Venice 2024 - 2024-12-04



Official Results

U21 Kumite Female -68 kg (Entries: 48 Nations: 21)			
1	RIEDEL HANNAH		GER - GERMANY
2	TINAVSKA EMA		CZE - CZECH REPUBLIC
3	FOHLINSKA VIRA		UKR - UKRAINE
3	ÁDÁM ALEXANDRA		HUN - HUNGARY
5	SAGYNBEK LAURA		KAZ - KAZAKHSTAN
5	PORQUET FAITH		FRA - FRANCE
7	SIMONINI VALENTINA		ITA - ITALY
7	SAADAQOI SONYA		FIN - FINLAND
9	PORTOGHESE MORENA		ITA - ITALY
9	GIORDANI PAOLA		ITA - ITALY
11	KALAMÁROVÁ ALEXANDRA		SVK - SLOVAKIA
11	VERVOORT TESS		BEL - BELGIUM

U21 KUMITE FEMALE 68+ KG



Karate1 Youth League - Venice 2024

ENTRIES BY WEIGHT CATEGORY



U21 Kumite Female 68+ kg

As of 8 DEC 2024

Country Code	ID	Gender	Name	Seeding
AUT	AUT02524	F	SCHUETZE EMMA	
BIH	BIH2708	F	Muhovic Nadja	
BIH	BIH2604	F	SIPOVIC AJLA	
CZE	CZE02421	F	STASTNA BARBORA	
CZE	CZE02714	F	STECOVA KATERINA	
ENG	ENG02510	F	Allsopp Amber	
ENG		F	Hambleton Kate	
ENG	ENG02473	F	Holdsworth Eve	
ESP		F	RAMIREZ ORTEGA PAULA	
GER	GER03138	F	Rühlmann Charlotte	
GRE	GRE02831	F	ANASTASIOU MARIA-GEORGIA	
HUN	HUN02677	F	Fleischer Dóra	
IRL	IRL02797	F	CLARE AVA	
IRL	IRL003058	F	MCCRACKEN KATELYNN	
IRL	IRL02329	F	MCDERMOTT ZOE	
ITA		F	De Rosa Sofia	
ITA		F	DI BARI GEMMA	
ITA		F	D AURELI FLAVIA	
ITA		F	Lugato Maria Sofia	
ITA		F	Murolo Francesca Pia	
ITA	ITA03079	F	PERGOLESI ASIA	
ITA	ITA03080	F	Pergolesi Aurora	
ITA		F	Plutino Francesca	
ITA		F	SARI CHIARA	
KOS	KOS2252	F	GASHI VALEZA	
KOS	KOS2387	F	MAHALLA DIELLZA	
POR		F	Asturiano Maria	
ROU	ROU2185	F	COMAN MARIA CRISTINA	
SCO	SCO2155	F	Ewing Neve	
SLO	SLO2448	F	ZIBRET ZALA MARIA	
SUI	SUI02568	F	Bonny Shanja	
SUI		F	Jenic Andrijana	
SVK	SVK02761	F	Erdelyiova Nina	
SWE	SWE02480	F	BAO BEDNARSKI SOPHIE	
TPE	TPE02743	F	LIN YI-HSUAN	
UKR	UKR02915	F	Krot Yuliia	
UKR	UKR02524	F	Rusu Yuliia	

U21 Kumite Female 68+ kg

Karate1 Youth League - Venice 2024, PALAZZO DEL TURISMO, Piazza Brescia 11, 30016 Lido di Jesolo VE, ITA

2024-12-04

Tatami
7 16:15

Pool
1/2

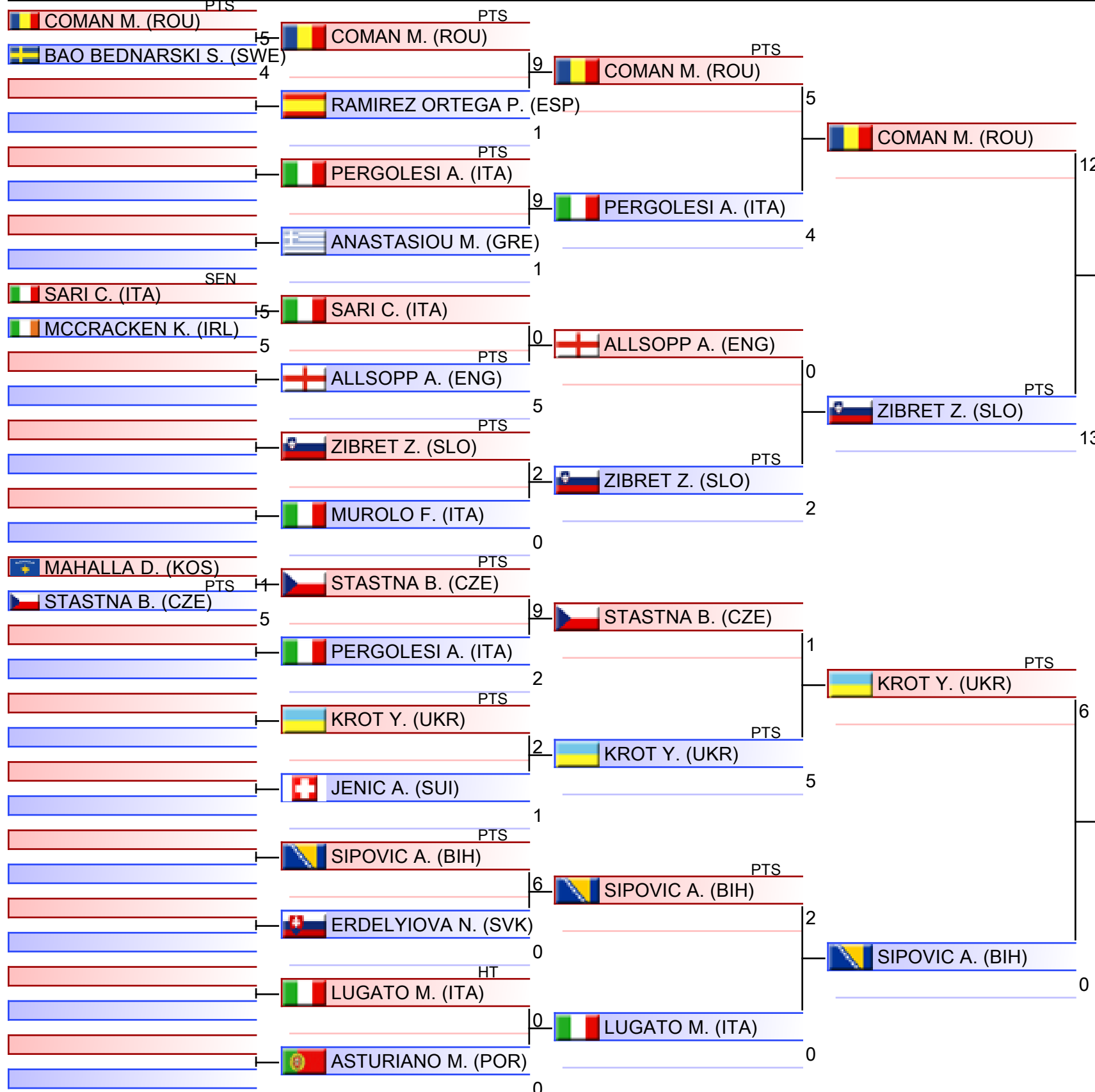

1. RUSU YULIIA (UKR)
2. KROT YULIIA (UKR)
3. ZIBRET ZALA MARIA (SLO)
3. SCHUETZE EMMA (AUT)
5. SIPOVIC AJLA (BIH)
5. STECOVA KATERINA (CZE)
7. STASTNA BARBORA (CZE)
7. MCDERMOTT ZOE (IRL)

U21 Kumite Female 68+ kg

Karate1 Youth League - Venice 2024, PALAZZO DEL TURISMO, Piazza Brescia 11, 30016 Lido di Jesolo VE, ITA

2024-12-04

Tatami
8 16:15

Pool
2/2

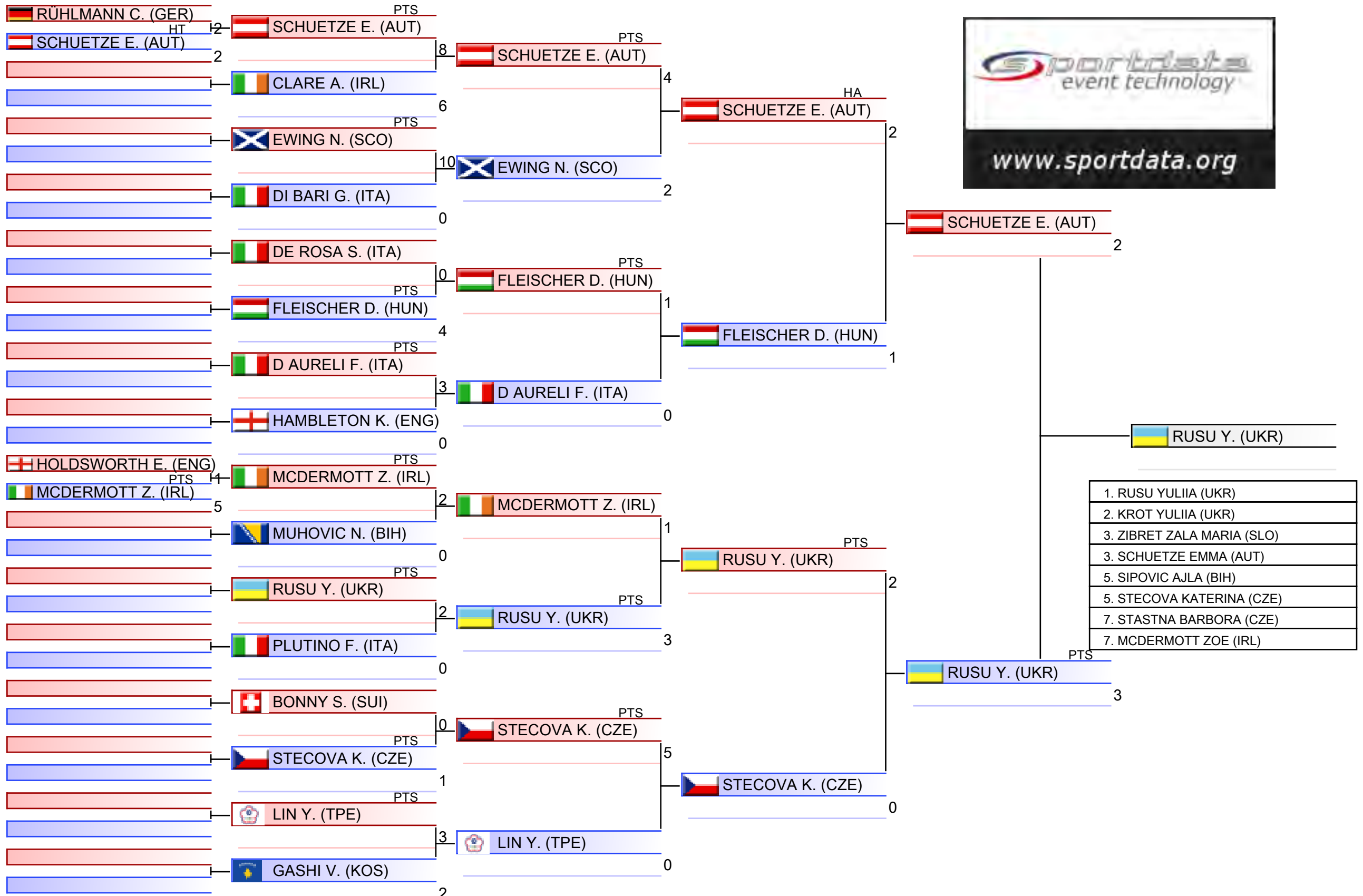

1. RUSU YULIIA (UKR)
2. KROT YULIIA (UKR)
3. ZIBRET ZALA MARIA (SLO)
3. SCHUETZE EMMA (AUT)
5. SIPOVIC AJLA (BIH)
5. STECOVA KATERINA (CZE)
7. STASTNA BARBORA (CZE)
7. MCDERMOTT ZOE (IRL)

Pool winner-U21 Kumite Female 68+ kg

Karate1 Youth League - Venice 2024, PALAZZO DEL TURISMO, Piazza Brescia 11, 30016 Lido di Jesolo VE, ITA

Tatami

Pool

1/1

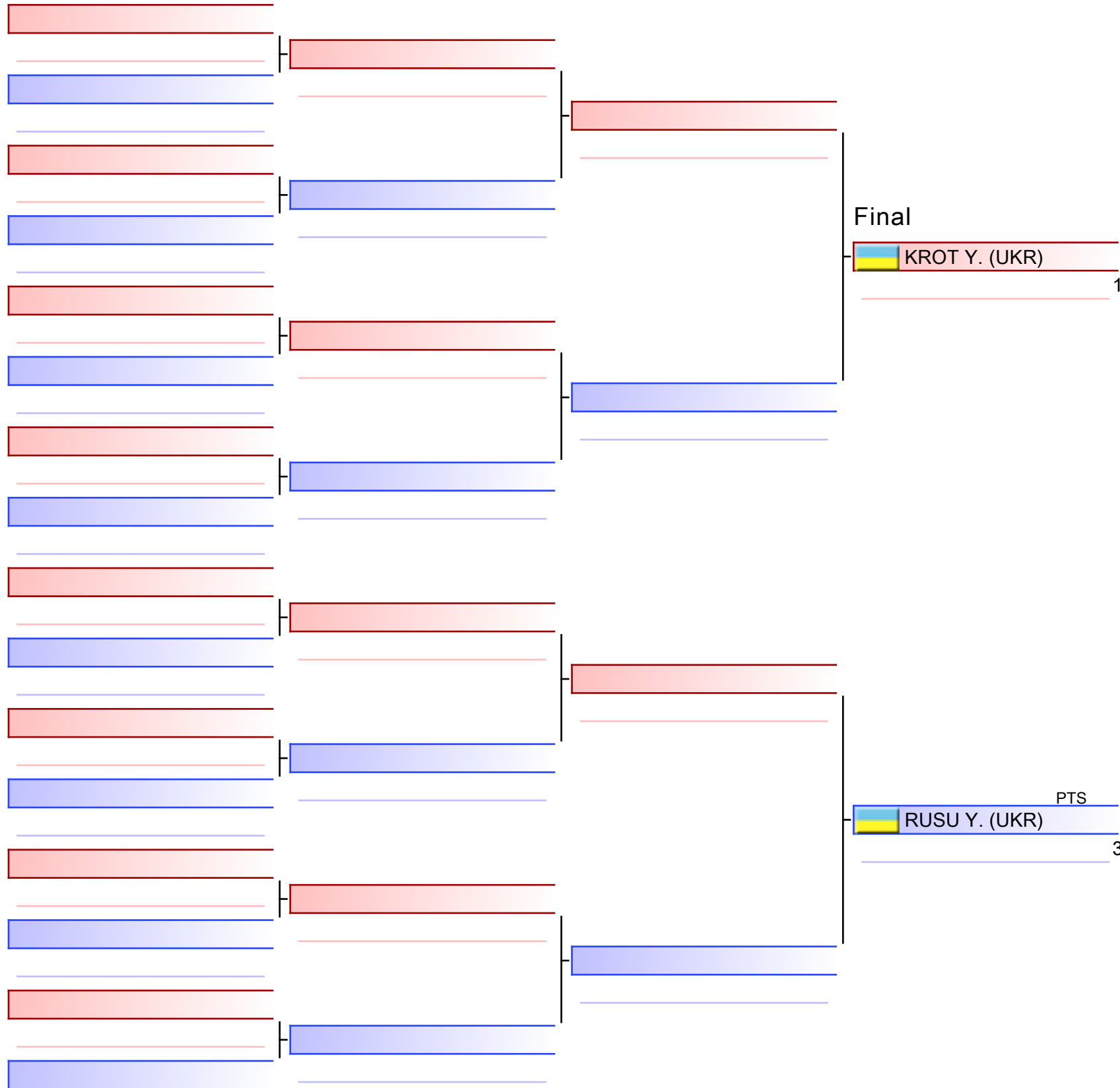

Final

KROT Y. (UKR) 1

RUSU Y. (UKR) 3

PTS

1. RUSU YULIIA (UKR)
2. KROT YULIIA (UKR)
3. ZIBRET ZALA MARIA (SLO)
3. SCHUETZE EMMA (AUT)
5. SIPOVIC AJLA (BIH)
5. STECOVA KATERINA (CZE)
7. STASTNA BARBORA (CZE)
7. MCDERMOTT ZOE (IRL)

U21 Kumite Female 68+ kg

Karate1 Youth League - Venice 2024

2024-12-04

Tatami
8 18:15

Pool
1,2

(c)sportdata GmbH & Co KG 2000-2024 (2024-12-08 20:16) v 10.2.0 build 1 (2024-11-20 00:58 CET) License: SDIL TVG (expire 2025-01-26)

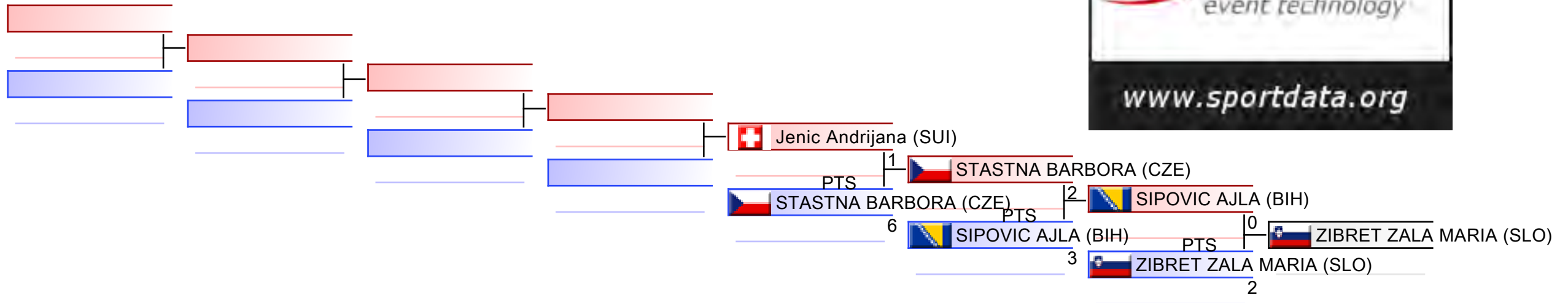

REPECHAGE: (1,2)

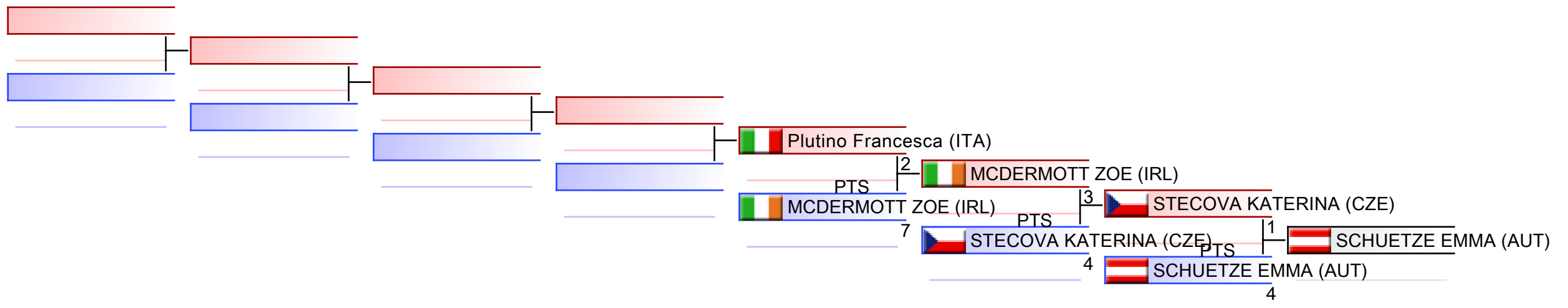



Karate1 Youth League - Venice 2024 - 2024-12-04



Official Results

U21 Kumite Female 68+ kg (Entries: 37 Nations: 20)			
1	RUSU YULIIA		UKR - UKRAINE
2	KROT YULIIA		UKR - UKRAINE
3	ZIBRET ZALA MARIA		SLO - SLOVENIA
3	SCHUETZE EMMA		AUT - AUSTRIA
5	SIPOVIC AJLA		BIH - BOSNIA AND HERZEGOVINA
5	STECOVA KATERINA		CZE - CZECH REPUBLIC
7	STASTNA BARBORA		CZE - CZECH REPUBLIC
7	MCDERMOTT ZOE		IRL - IRELAND
9	JENIC ANDRIJANA		SUI - SWITZERLAND
9	PLUTINO FRANCESCA		ITA - ITALY

U21 KUMITE MALE -60 KG



Karate1 Youth League - Venice 2024

ENTRIES BY WEIGHT CATEGORY



U21 Kumite Male -60 kg
As of 8 DEC 2024

Country Code	ID	Gender	Name	Seeding
AUT	AUT02480	M	Lang Marcus	
BEL	BEL02291	M	ABDELMALKI AMIN	
BEL		M	El aalili Ali	
BEL	BEL02329	M	ghazouani yassin	
BEN	BEN02086	M	KPADONOU MARTIAL	
BIH	BIH03169	M	Jasarevic Kerim	
BIH	BIH004860	M	KADRIC FARUK	
BIH		M	Mujić Alen	
BIH		M	Šiljak Kenan	
CAN		M	Ferjani Yosri	
CRO	CRO2533	M	DONADIC NINO	
CRO		M	Drazenovic Damian	
CRO	CRO2445	M	TOPLICANEC NIKOLA	
CYP	CYP02765	M	CHRISTODOULOU MARIOS	
CYP	CYP2206	M	GAVRIEL ANDREAS	
ENG	ENG03251	M	Black Joseph	
ENG	ENG02824	M	Giurma-Handley Thomas	
ENG	ENG02581	M	Moran Jack	
ENG	SD60794	M	Ody Becson	
ENG		M	Yogarajah Kobe	
ESP		M	Corpas Coronado Ramon Jesus	
ESP		M	ESPARZA GONZALO	
FRA		M	Alalou Ilias	
FRA	FRA02767	M	FALCO Enzo	
FRA	FRA03434	M	PIERROT GASPARD	
GER		M	Blumenauer Alec	
GER	GER03148	M	Nowizki Michael	
GER	GER03121	M	Obitz Florian	
GER	GER2584	M	Özdemir Muhammed	
GRE		M	MERKOURIS THEODOROS	
ITA	ITA03008	M	AGUS MARIO	
ITA	ITA04283	M	alfano nicolò	
ITA		M	aureli leonardo	
ITA		M	CARRABINO Alessandro	
ITA		M	GALASSO Lorenzo	
ITA	ITA04424	M	MALLARDI Alessio	
ITA		M	Mearini Gioele	
ITA	ITA435470	M	PAGNOTTA ALESSANDRO	
ITA	ITA04267	M	Pelagalli Matteo	
ITA		M	PIEMONTE GABRIEL	
ITA		M	PIERBATTISTI RICCARDO	
ITA	ITA03015	M	RISSO LEANDRO	
ITA	ITA03865	M	Sabatino Christian	
ITA	ITA03002	M	SPAMPINATO MARCO GAETANO	
ITA		M	SQUILLANTE GUIDO	



Karate1 Youth League - Venice 2024

ENTRIES BY WEIGHT CATEGORY



U21 Kumite Male -60 kg

As of 8 DEC 2024

Country Code	ID	Gender	Name	Seeding
KUW	KUW02261	M	ALAJMI ALI	
KUW	KUW02552	M	ALAJMI SALEM	
KUW	KUW02404	M	ALDWUAILAH ABDULHADI	
KUW	KUW02265	M	ALHARBY YOSIF	
KUW	KUW02264	M	ALMUTAIRI ABDULLAH	
NCL		M	EVLAKHOFF Kurth	
NOR	NOR02263	M	Hansen Henrik Walstad	
NOR	NOR02268	M	Kristensen Petter	
NOR		M	Pettersen Johannes Mohn	
POL	POL06606	M	Kwaśniewski Arkadiusz	
POL	POL2956	M	OPAS ALEKSANDER	
POR		M	Martins João	
POR	POR02709	M	OLIVEIRA GUSTAVO	
ROU	ROU2183	M	TORNACI ERHAN	
SCO	SCO02194	M	Hamill Adam	
SUI	SUI02276	M	Jost Ruben	
SUI		M	Khames Ahmad	
SVK		M	Dolnický Adam	
TKM	TKM02335	M	ANNAYEV MAGTYMGULY	
TKM	TKM02034	M	ATAJANOV RASUL	
TKM	TKM02545	M	GARAMAMMEDOV GARAMAMMET	
TPE	TPE02734	M	HSU LI-WEI	
TUR		M	AKGUL BARIS	
TUR	TUR03810	M	AKKAYA ALISAN	
UKR	UKR03008	M	Lomovatskyi Hlib	
UKR	UKR02452	M	Mezentsev Zakhar	
USA	USA02983	M	Cruz Kevin	
USA		M	Dolinyan Davit	

U21 Kumite Male -60 kg

Karate1 Youth League - Venice 2024, PALAZZO DEL TURISMO, Piazza Brescia 11, 30016 Lido di Jesolo VE, ITA

2024-12-04

Tatami
1 12:30

Pool
1/4

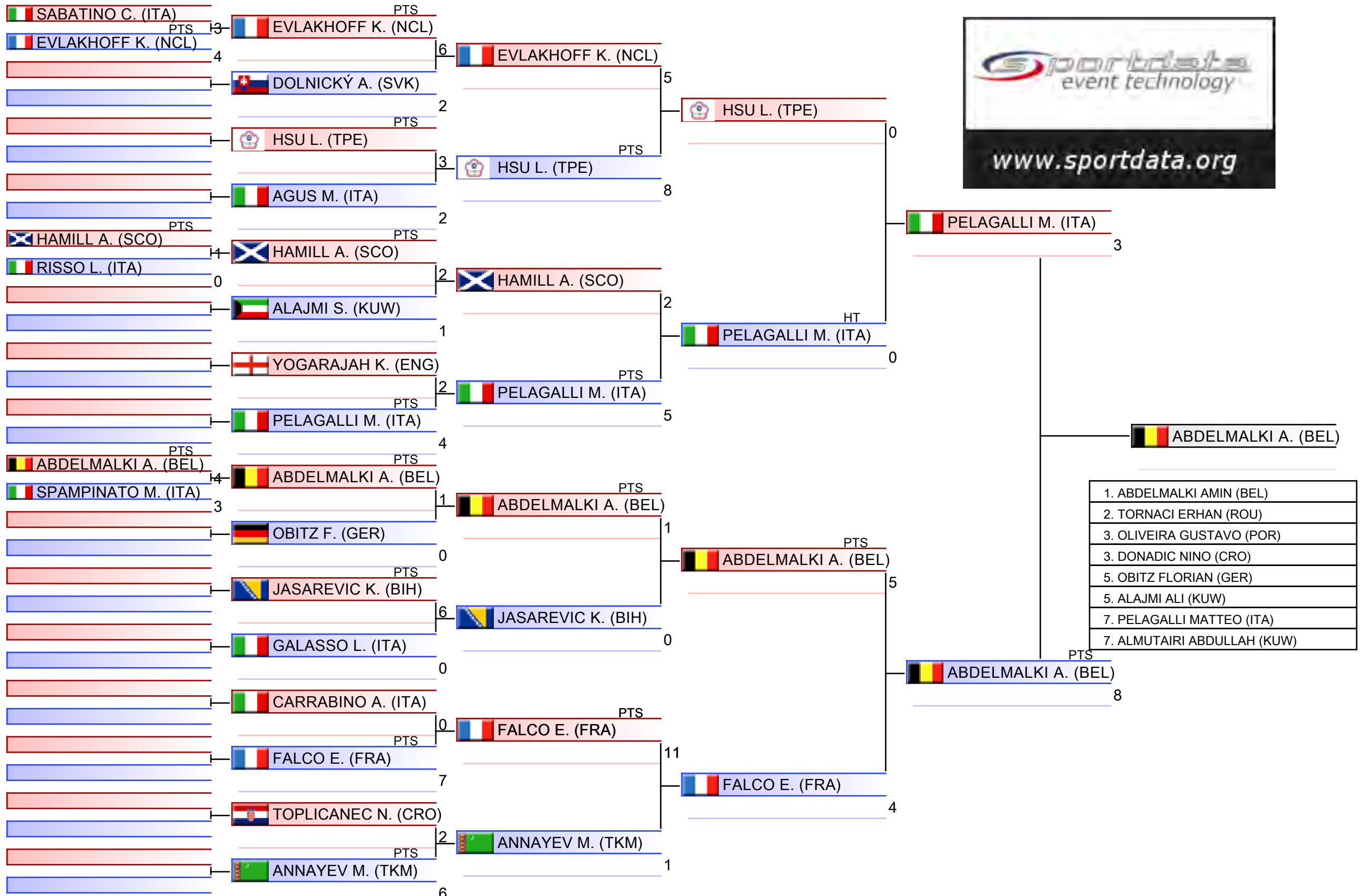

1.	ABDELMALKI AMIN (BEL)
2.	TORNACI ERHAN (ROU)
3.	OLIVEIRA GUSTAVO (POR)
3.	DONADIC NINO (CRO)
5.	OBITZ FLORIAN (GER)
5.	ALAJMI ALI (KUW)
7.	PELAGALLI MATTEO (ITA)
7.	ALMUTAIRI ABDULLAH (KUW)

U21 Kumite Male -60 kg

Karate1 Youth League - Venice 2024, PALAZZO DEL TURISMO, Piazza Brescia 11, 30016 Lido di Jesolo VE, ITA

2024-12-04

Tatami
2 12:30

Pool
2/4

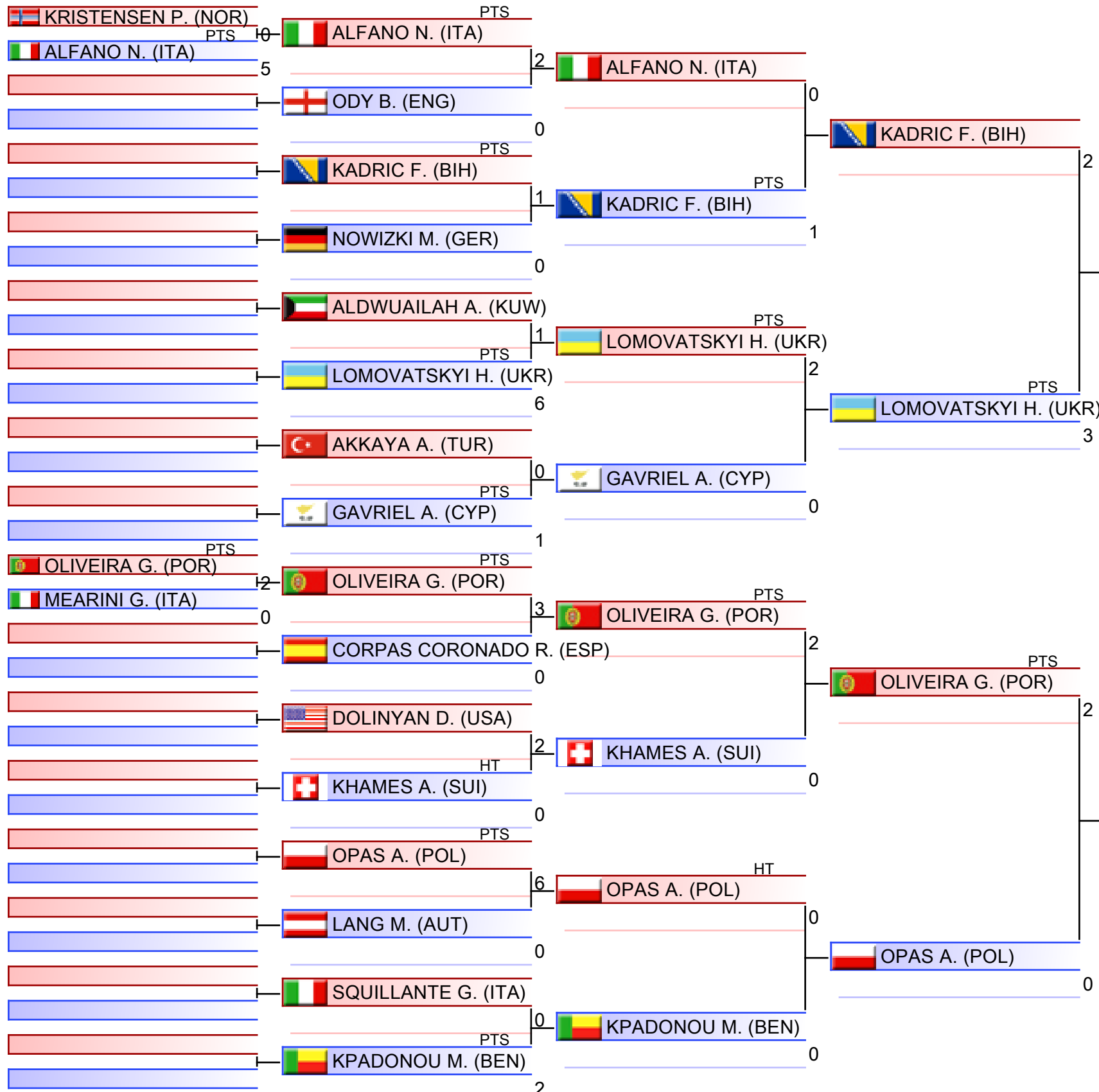

1. ABDELMALKI AMIN (BEL)
2. TORNACI ERHAN (ROU)
3. OLIVEIRA GUSTAVO (POR)
3. DONADIC NINO (CRO)
5. OBITZ FLORIAN (GER)
5. ALAJMI ALI (KUW)
7. PELAGALLI MATTEO (ITA)
7. ALMUTAIRI ABDULLAH (KUW)

U21 Kumite Male -60 kg

Karate1 Youth League - Venice 2024, PALAZZO DEL TURISMO, Piazza Brescia 11, 30016 Lido di Jesolo VE, ITA

2024-12-04

Tatami
3 12:30

Pool
3/4

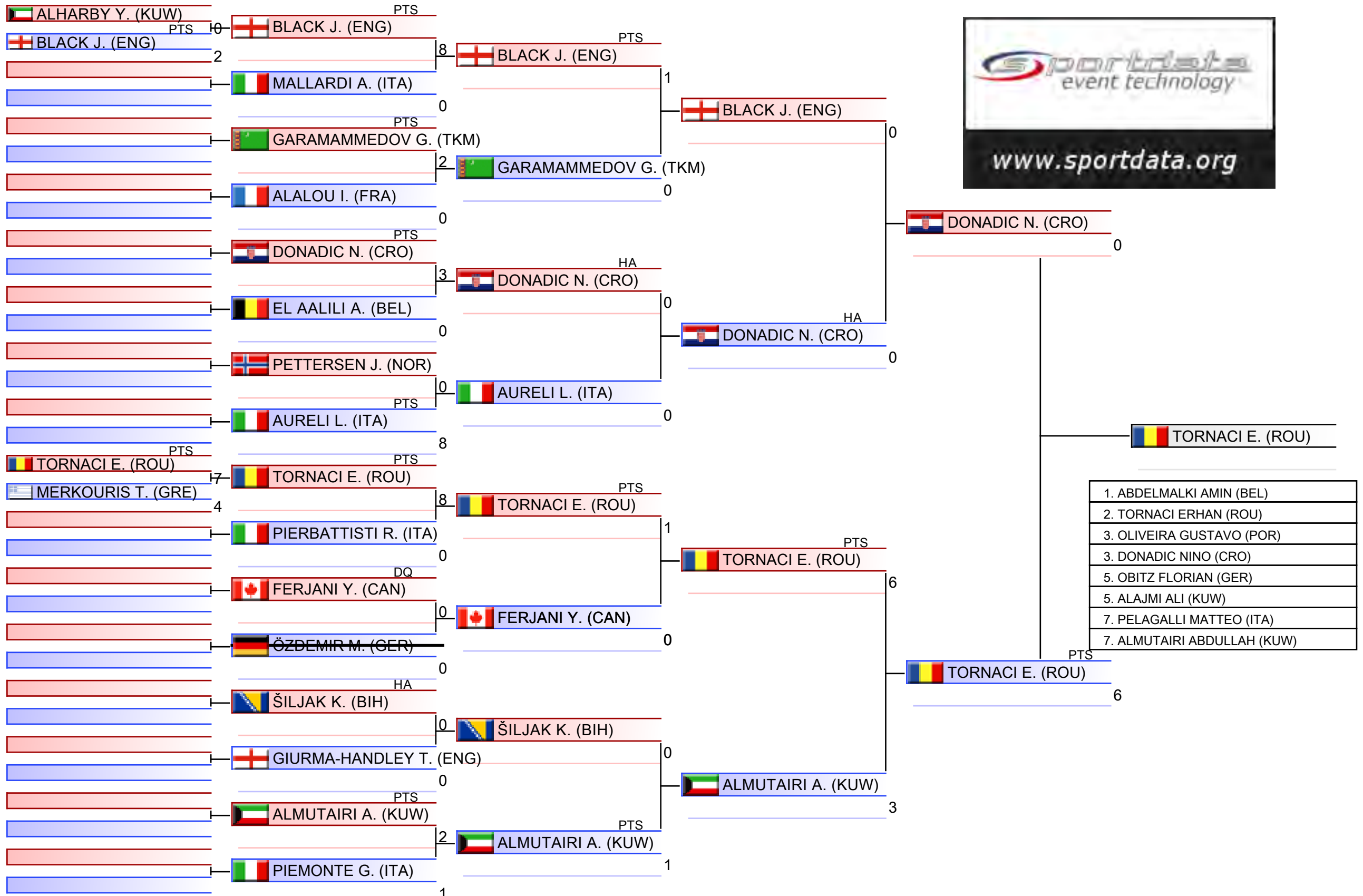

1. ABDELMALKI AMIN (BEL)
2. TORNACI ERHAN (ROU)
3. OLIVEIRA GUSTAVO (POR)
3. DONADIC NINO (CRO)
5. OBITZ FLORIAN (GER)
5. ALAJMI ALI (KUW)
7. PELAGALLI MATTEO (ITA)
7. ALMUTAIRI ABDULLAH (KUW)

U21 Kumite Male -60 kg

Karate1 Youth League - Venice 2024, PALAZZO DEL TURISMO, Piazza Brescia 11, 30016 Lido di Jesolo VE, ITA

2024-12-04

Tatami
4 12:30

Pool
4/4

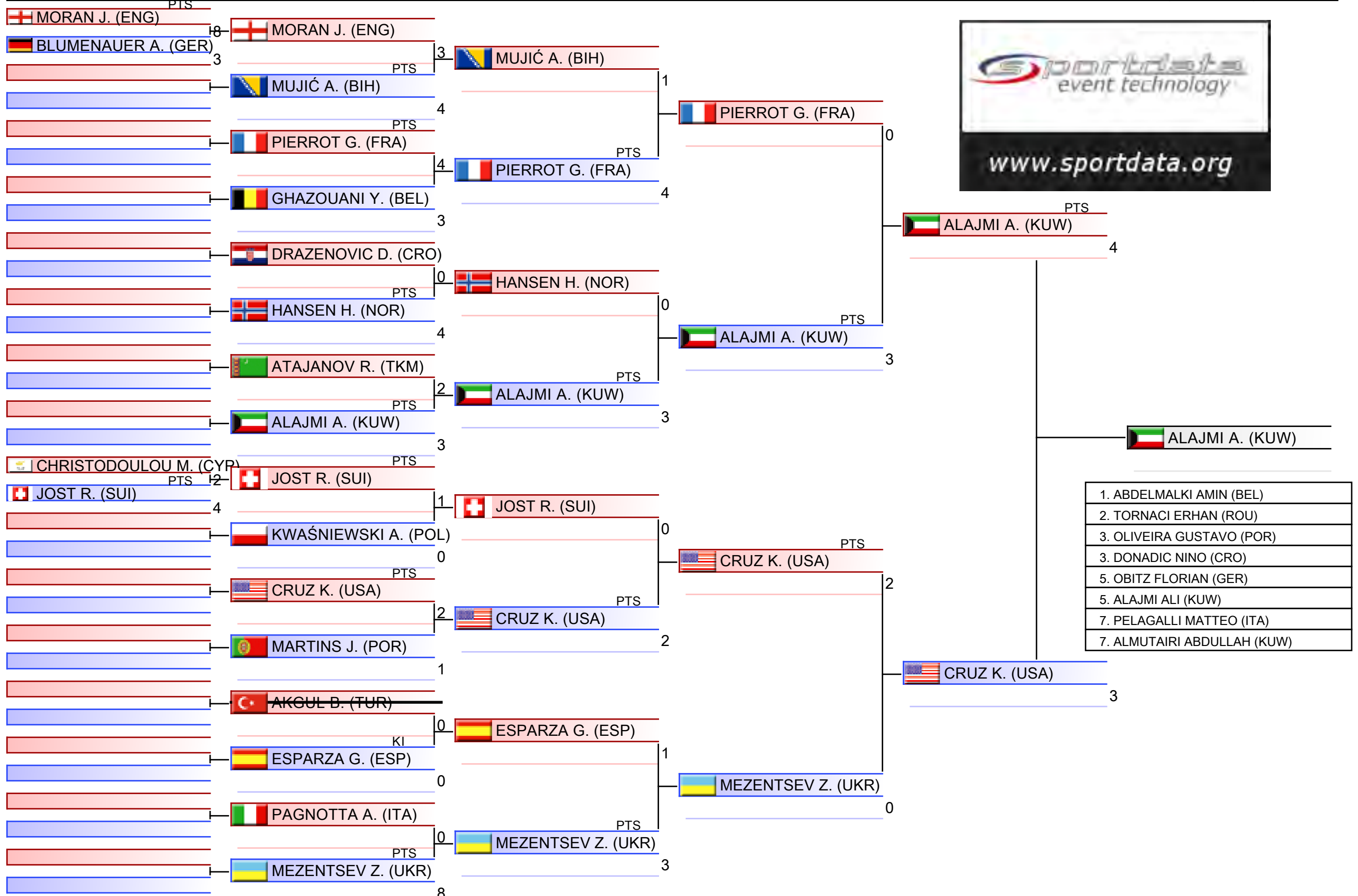

1. ABDELMALKI AMIN (BEL)
2. TORNACI ERHAN (ROU)
3. OLIVEIRA GUSTAVO (POR)
3. DONADIC NINO (CRO)
5. OBITZ FLORIAN (GER)
5. ALAJMI ALI (KUW)
7. PELAGALLI MATTEO (ITA)
7. ALMUTAIRI ABDULLAH (KUW)

Pool winner-U21 Kumite Male -60 kg

Karate1 Youth League - Venice 2024, PALAZZO DEL TURISMO, Piazza Brescia 11, 30016 Lido di Jesolo VE, ITA

2024-12-04

Tatami

3 14:15

Pool

1/1

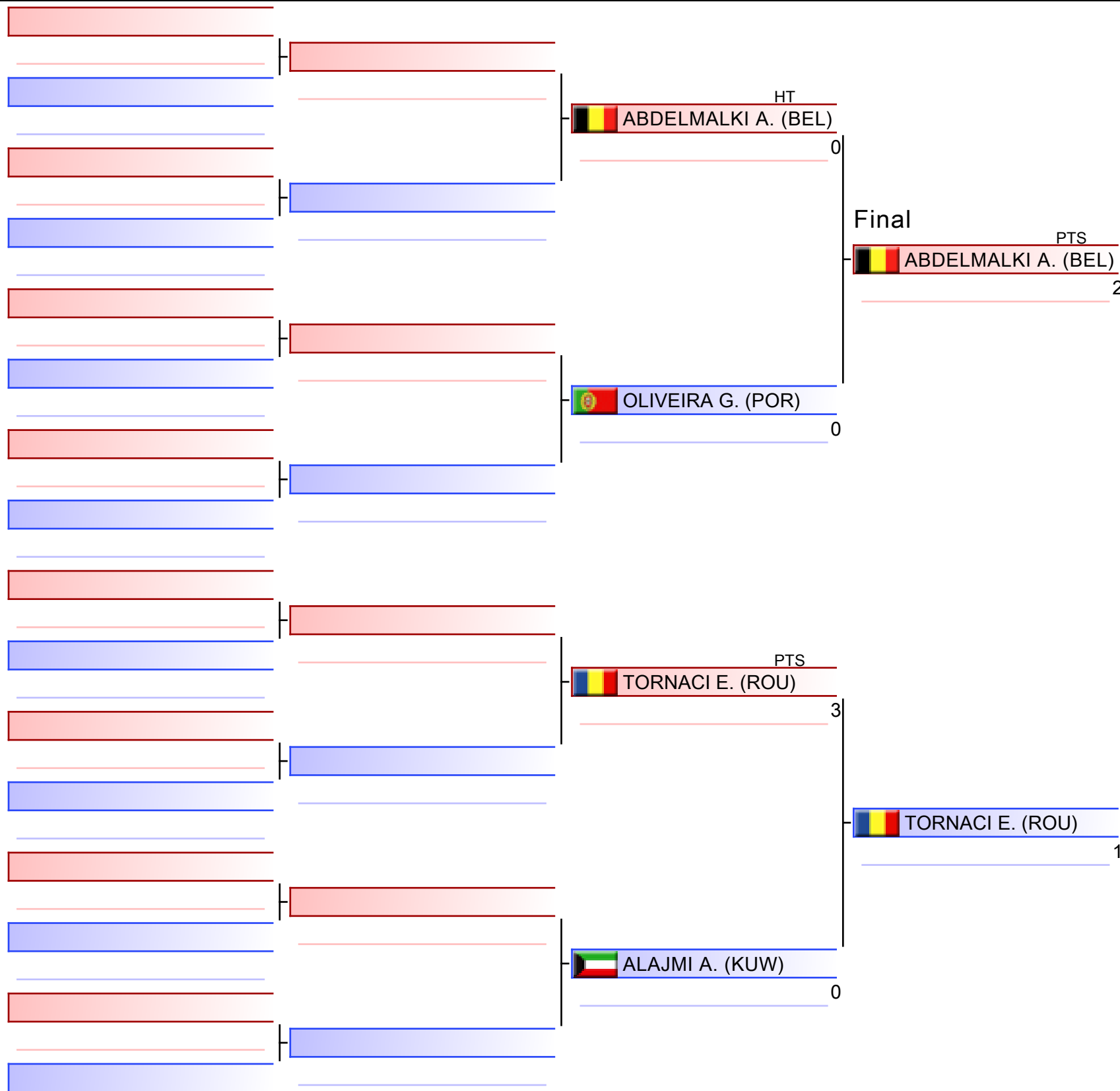

ABDELMALKI A. (BEL)

1. ABDELMALKI AMIN (BEL)
2. TORNACI ERHAN (ROU)
3. OLIVEIRA GUSTAVO (POR)
3. DONADIC NINO (CRO)
5. OBITZ FLORIAN (GER)
5. ALAJMI ALI (KUW)
7. PELAGALLI MATTEO (ITA)
7. ALMUTAIRI ABDULLAH (KUW)

U21 Kumite Male -60 kg

Karate1 Youth League - Venice 2024

2024-12-04

Tatami
1 18:15

Pool
1,2,3,4

(c)sportdata GmbH & Co KG 2000-2024 (2024-12-08 20:16) v 10.2.0 build 1 (2024-11-20 00:58 CET) License: SDIL TVG (expire 2025-01-26)

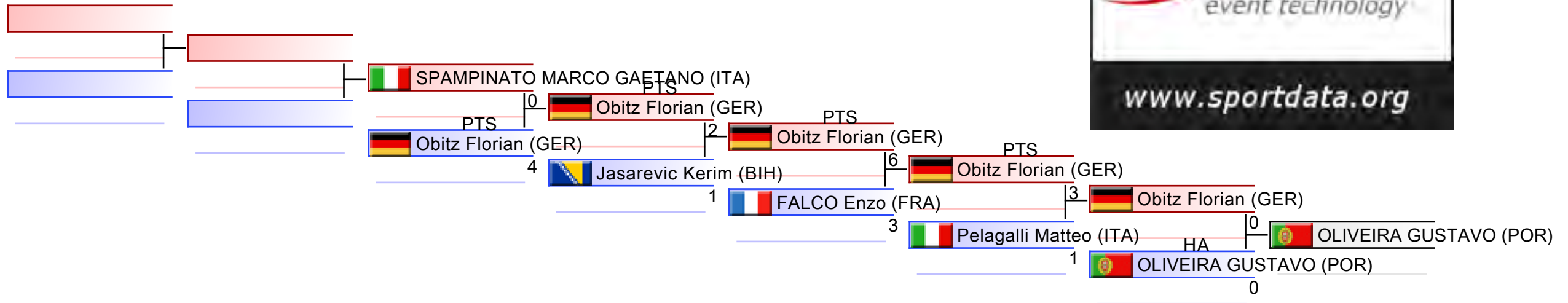

REPECHAGE: (1,2,3,4)

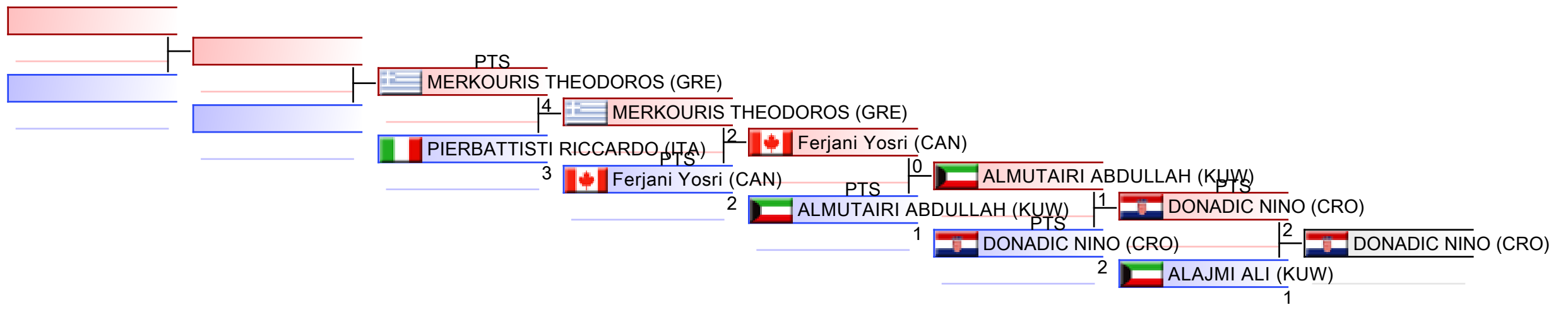



Karate1 Youth League - Venice 2024 - 2024-12-04



Official Results

U21 Kumite Male -60 kg (Entries: 73 Nations: 27)			
1	ABDELMALKI AMIN		BEL - BELGIUM
2	TORNACI ERHAN		ROU - ROMANIA
3	OLIVEIRA GUSTAVO		POR - PORTUGAL
3	DONADIC NINO		CRO - CROATIA
5	OBITZ FLORIAN		GER - GERMANY
5	ALAJMI ALI		KUW - KUWAIT
7	PELAGALLI MATTEO		ITA - ITALY
7	ALMUTAIRI ABDULLAH		KUW - KUWAIT
9	FALCO ENZO		FRA - FRANCE
9	FERJANI YOSRI		CAN - CANADA
11	JASAREVIC KERIM		BIH - BOSNIA AND HERZEGOVINA
11	MERKOURIS THEODOROS		GRE - GREECE
13	SPAMPINATO MARCO GAETANO		ITA - ITALY
13	PIERBATTISTI RICCARDO		ITA - ITALY

U21 KUMITE MALE -67 KG



Karate1 Youth League - Venice 2024

ENTRIES BY WEIGHT CATEGORY



U21 Kumite Male -67 kg
As of 8 DEC 2024

Country Code	ID	Gender	Name	Seeding
ARM	ARM2142	M	HARUTYUNYAN SUREN	
ARU		M	PRADA SUNCO KEVEN	
BEL	BEL02529	M	Ejja Amine	
BEL	BEL02442	M	Jaber-Rais Hamza	
BEL		M	Mahyou Zayed	
BEL		M	Van Den Nieuwenhuijzen Leroy	
BIH		M	Grabus Bekir	
CRO	CRO2634	M	Frank Kristijan	
CRO	CRO03197	M	NASTESKI MATIJA	
CYP	CYP2342	M	TSANGARAS ALEXIS	
DEN	DEN02339	M	Linaa Mathias Bech	
ENG		M	Bartoletta Daniel	
ENG	ENG02618	M	Monk Luke	
ENG	ENG02777	M	TOUTAYO HUSSEIN	
ESP		M	FEO CABO VICTOR	
FRA	FRA03557	M	BAKAS KENAN	
FRA	FRA03558	M	CHEVALIER MATHIS	
FRA	FRA02784	M	HIERSO Hairiss	
FRA	FRA02973	M	KE GRIFFIN	
FRA		M	Parameswaran Anishtan	
FRA	FRA03458	M	Titouah Massinissa	
GER	GER03288	M	Aktas Fatih	
GER		M	Ganjzadeh Mohammad-Reza	
GER	GER02815	M	Stamer Narvik	
GRE	GRE02321	M	BALLOTIS GEORGIOS	
GRE	GRE2156	M	BITSORIS ANDREAS	
HKG	HKG02470	M	LI MAN HEI	
HUN		M	Szócs Ambrus	
HUN		M	Zsombor Dudás	
ITA	ITA04245	M	Astarita Raffaele	
ITA		M	Braja Gabriele	
ITA		M	CAVASIN ELIA	
ITA		M	Cioè Federico	
ITA	ITA04250	M	De Pascalis Devis	
ITA	ITA04577	M	DIGLIO Michele	
ITA		M	DI NOIA MARCO	
ITA	ITA02940	M	D ANNA ANDREA	
ITA		M	Ingenito Angelo	
ITA		M	LEONE GIUSEPPE	
ITA	ITA04202	M	Loffredo Francesco	
ITA	ITA02955	M	Lorenzetti Tommaso	
ITA		M	Lupattelli Andrea	
ITA		M	MORELLI GABRIELE	
ITA		M	Paoletti Mattia	
ITA	ITA04263	M	Pica Gian Lorenzo	



Karate1 Youth League - Venice 2024

ENTRIES BY WEIGHT CATEGORY



U21 Kumite Male -67 kg

As of 8 DEC 2024

Country Code	ID	Gender	Name	Seeding
ITA	ITA03001	M	Pignatti Francesco	
ITA	ITA03475	M	PROPIZIO PAOLO	
ITA		M	RAMOS MATT STEVEN AUGUSTIN	
ITA	ITA03828	M	Rufini Alessio	
ITA	ITA03827	M	Rufini Samuele	
ITA	ITA03801	M	Torti Lorenzo	
ITA		M	Trotta Riccardo	
ITA		M	Vergati Giuseppe	
MDA	MDA02267	M	CAPMOALE ALEXANDR	
MDA	MDA002534	M	GANEA BOGDAN	
MDA	MDA02231	M	GUTU CRISTIAN	
NED	NED02694	M	Achghouyab Samy	
NED		M	Roubos Sean	
NED	NED02683	M	Werff Kai	
POL	POL2485	M	Dziuda Dominik	
POL	POL09589	M	Machaj Jakub	
POL	POL3237	M	MAZUROWSKI KACPER	
POL	POL3362	M	ZAGOZDZAN IGOR	
POR	POR2294	M	Alves Rafael	
POR		M	Casal Daniel	
POR	POR02720	M	GONCALVES GUILHERME	
POR		M	Ribeiro Diogo	
POR	POR02465	M	Tojeira Diogo	
ROU	ROU2371	M	GRIGORIU STEFAN ANTON	
SLO	SLO02633	M	Suša Žiga	
SLO	SLO2427	M	ZARIC VID	
SUI	SUI02269	M	Lorenz Swan	
SUI	SUI02282	M	Torres Steven	
SVK	SVK02623	M	Kováč Simon	
SWE	SWE02428	M	Rosenlind Viktor	
TKM	TKM02618	M	KELETLIYEV DAYANCH	
TUR		M	ÖZTÜRK AHMET	
UKR	UKR02713	M	Bessarabov Anatolii	
UKR	UKR02697	M	Fedotov Dmytro	
UKR		M	Smokvin Oleksandr	
UKR	UKR2368	M	YANOVSKYI DAVYD	
VEN	VEN003081	M	SEBASTIAN RODRIGUEZ	

U21 Kumite Male -67 kg

Karate1 Youth League - Venice 2024, PALAZZO DEL TURISMO, Piazza Brescia 11, 30016 Lido di Jesolo VE, ITA

2024-12-04

Tatami
5 11:50

Pool
1/4

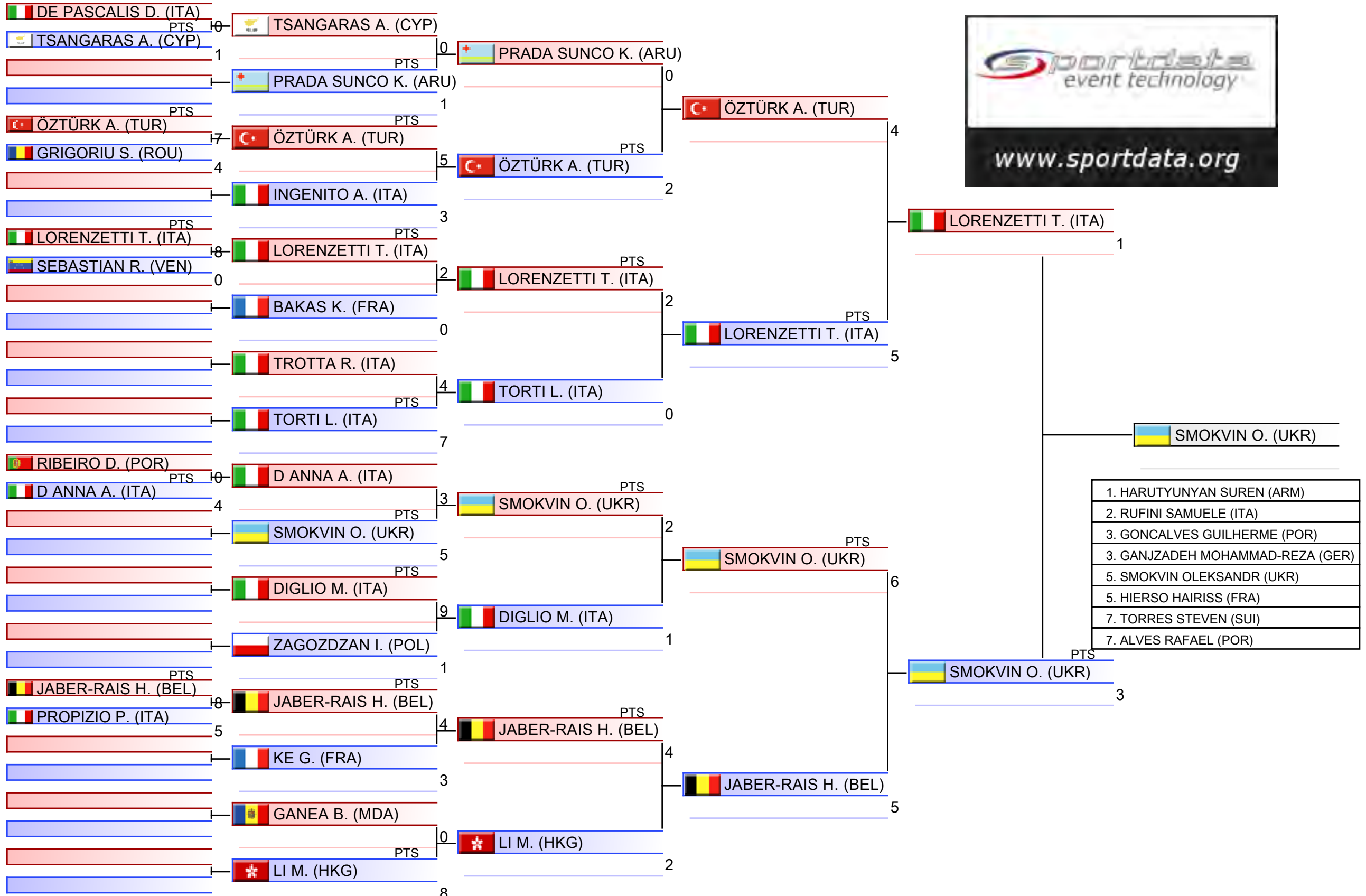

U21 Kumite Male -67 kg

Karate1 Youth League - Venice 2024, PALAZZO DEL TURISMO, Piazza Brescia 11, 30016 Lido di Jesolo VE, ITA

2024-12-04

Tatami

6 11:50

Pool

2/4

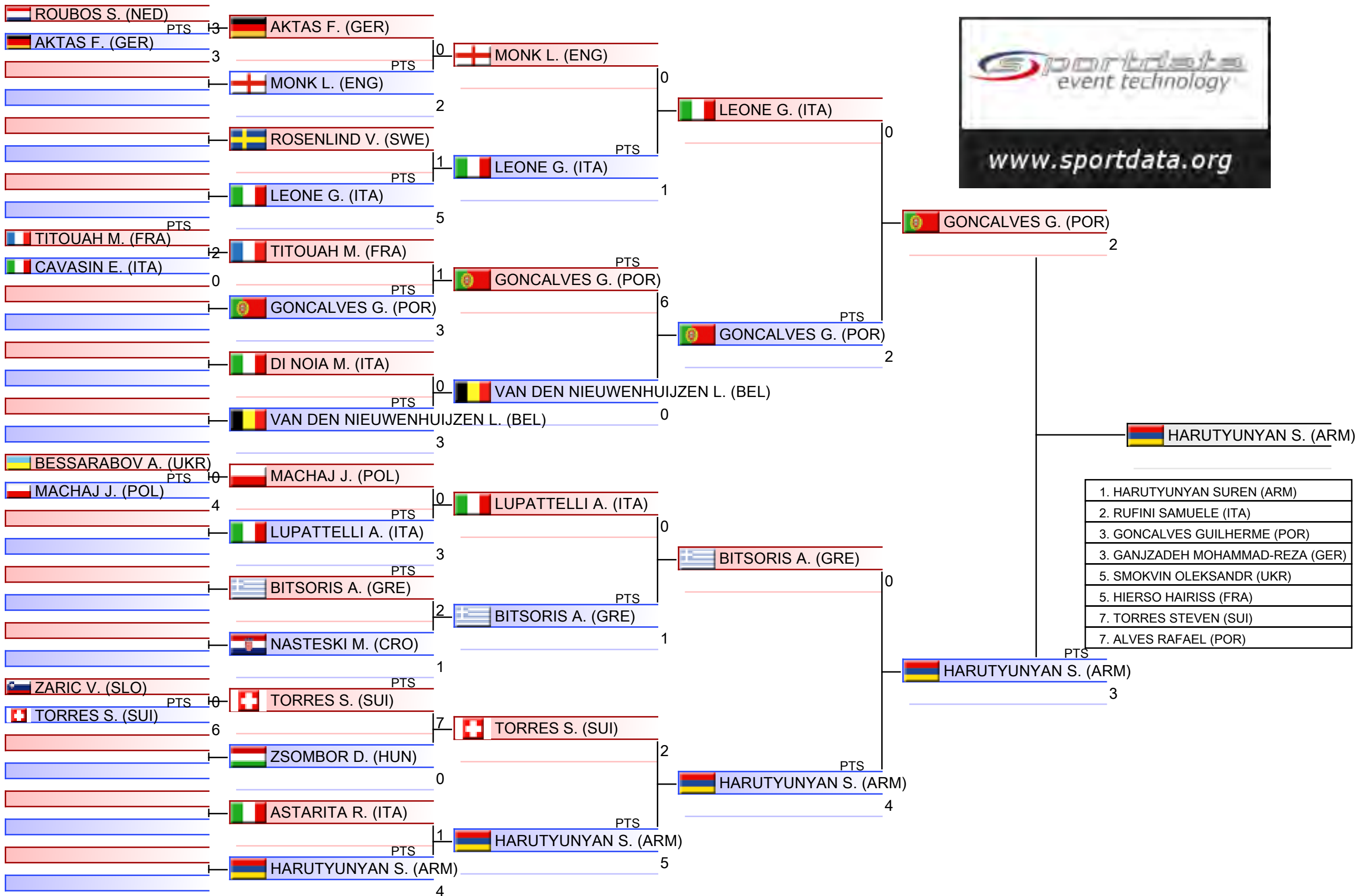

U21 Kumite Male -67 kg

Karate1 Youth League - Venice 2024, PALAZZO DEL TURISMO, Piazza Brescia 11, 30016 Lido di Jesolo VE, ITA

2024-12-04

Tatami
7 11:50

Pool
3/4

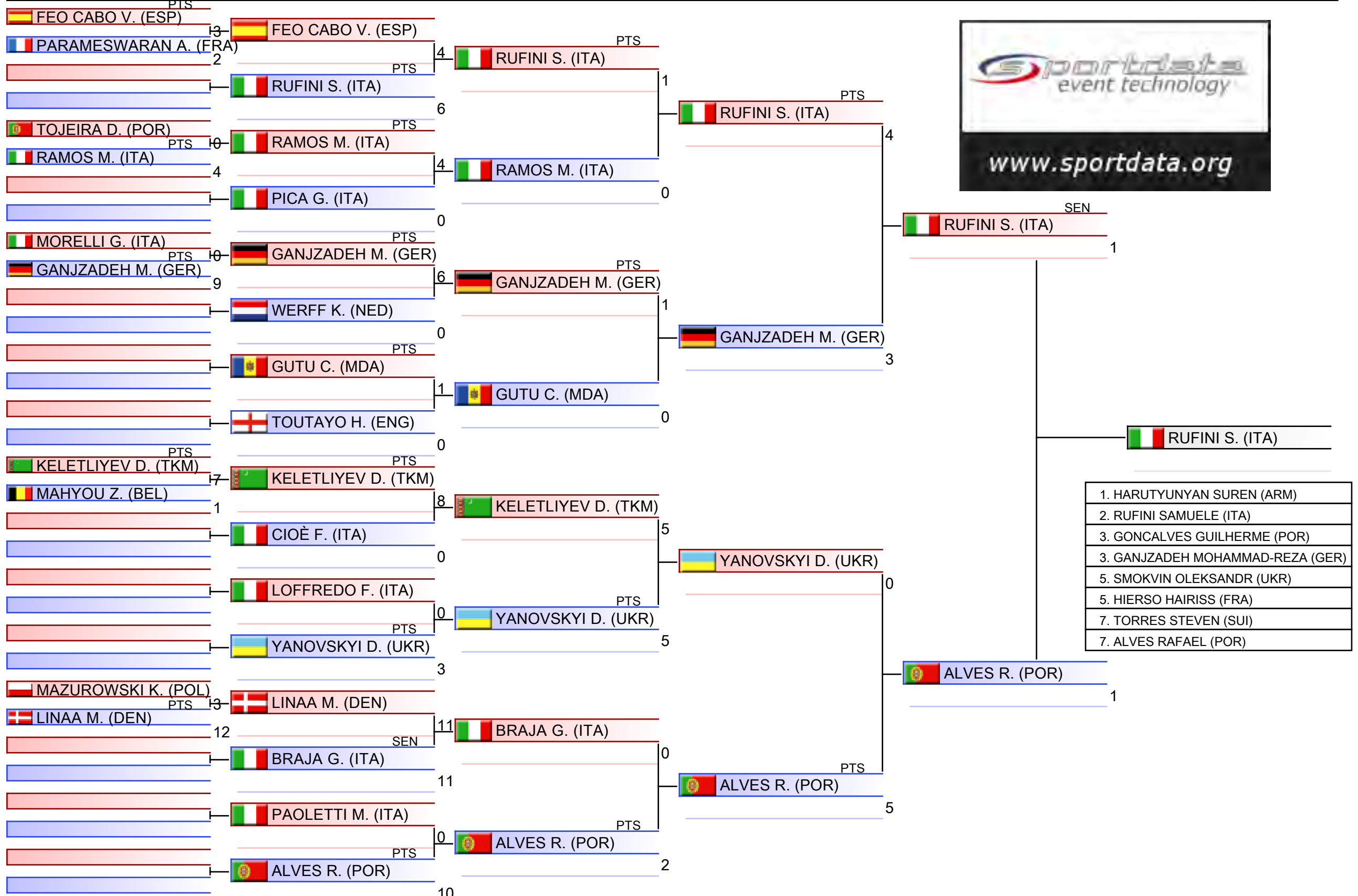

1.	HARUTYUNYAN SUREN (ARM)
2.	RUFINI SAMUELE (ITA)
3.	GONCALVES GUILHERME (POR)
3.	GANJZADEH MOHAMMAD-REZA (GER)
5.	SMOKVIN OLEKSANDR (UKR)
5.	HIERSO HAIRISS (FRA)
7.	TORRES STEVEN (SUI)
7.	ALVES RAFAEL (POR)

U21 Kumite Male -67 kg

Karate1 Youth League - Venice 2024, PALAZZO DEL TURISMO, Piazza Brescia 11, 30016 Lido di Jesolo VE, ITA

2024-12-04

Tatami
8 11:50

Pool
4/4

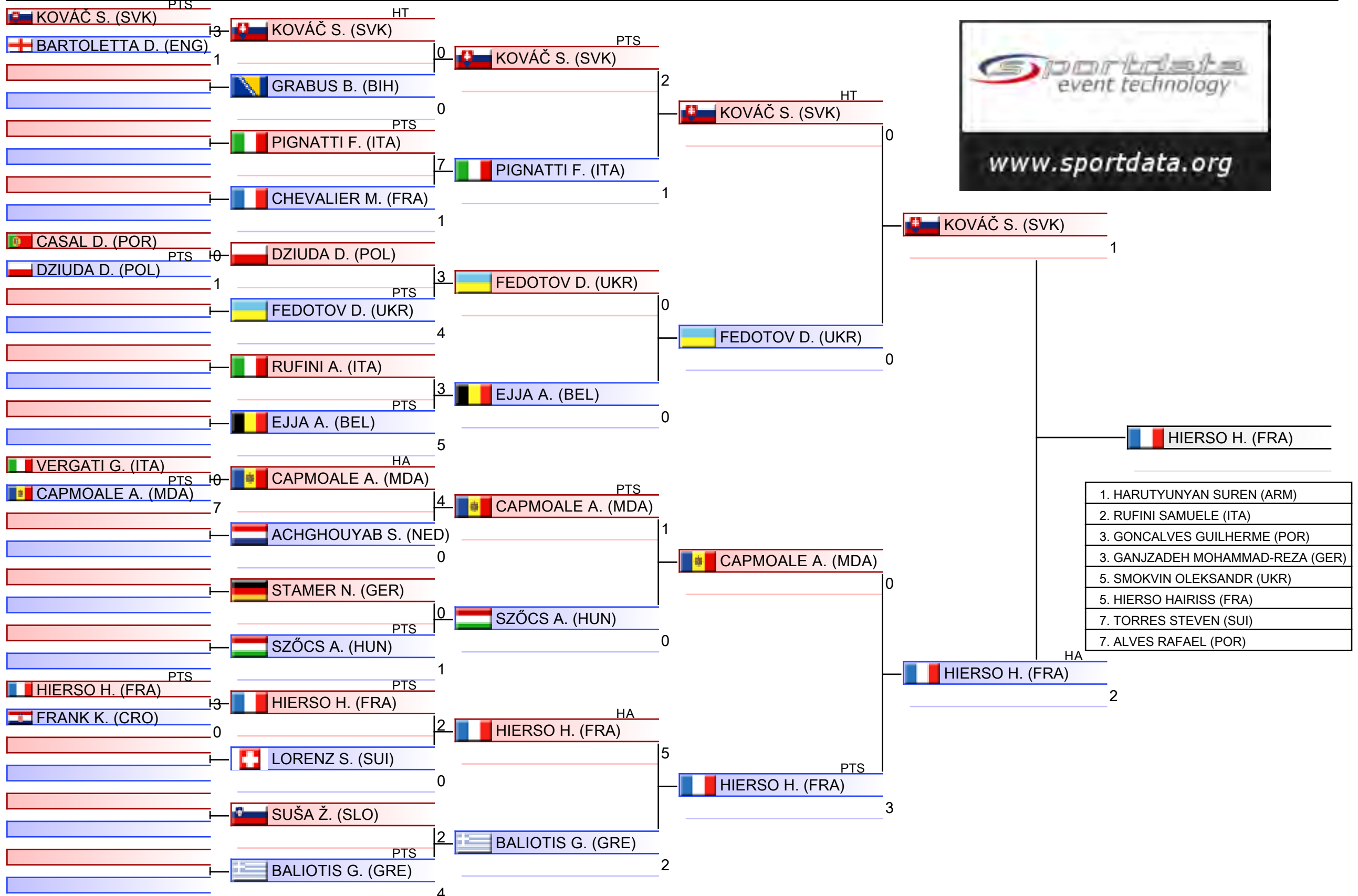

1.	HARUTYUNYAN SUREN (ARM)
2.	RUFINI SAMUELE (ITA)
3.	GONCALVES GUILHERME (POR)
3.	GANJZADEH MOHAMMAD-REZA (GER)
5.	SMOKVIN OLEKSANDR (UKR)
5.	HIERSO HAIRISS (FRA)
7.	TORRES STEVEN (SUI)
7.	ALVES RAFAEL (POR)

Pool winner-U21 Kumite Male -67 kg

Karate1 Youth League - Venice 2024, PALAZZO DEL TURISMO, Piazza Brescia 11, 30016 Lido di Jesolo VE, ITA

2024-12-04

Tatami
7 13:55

Pool
1/1

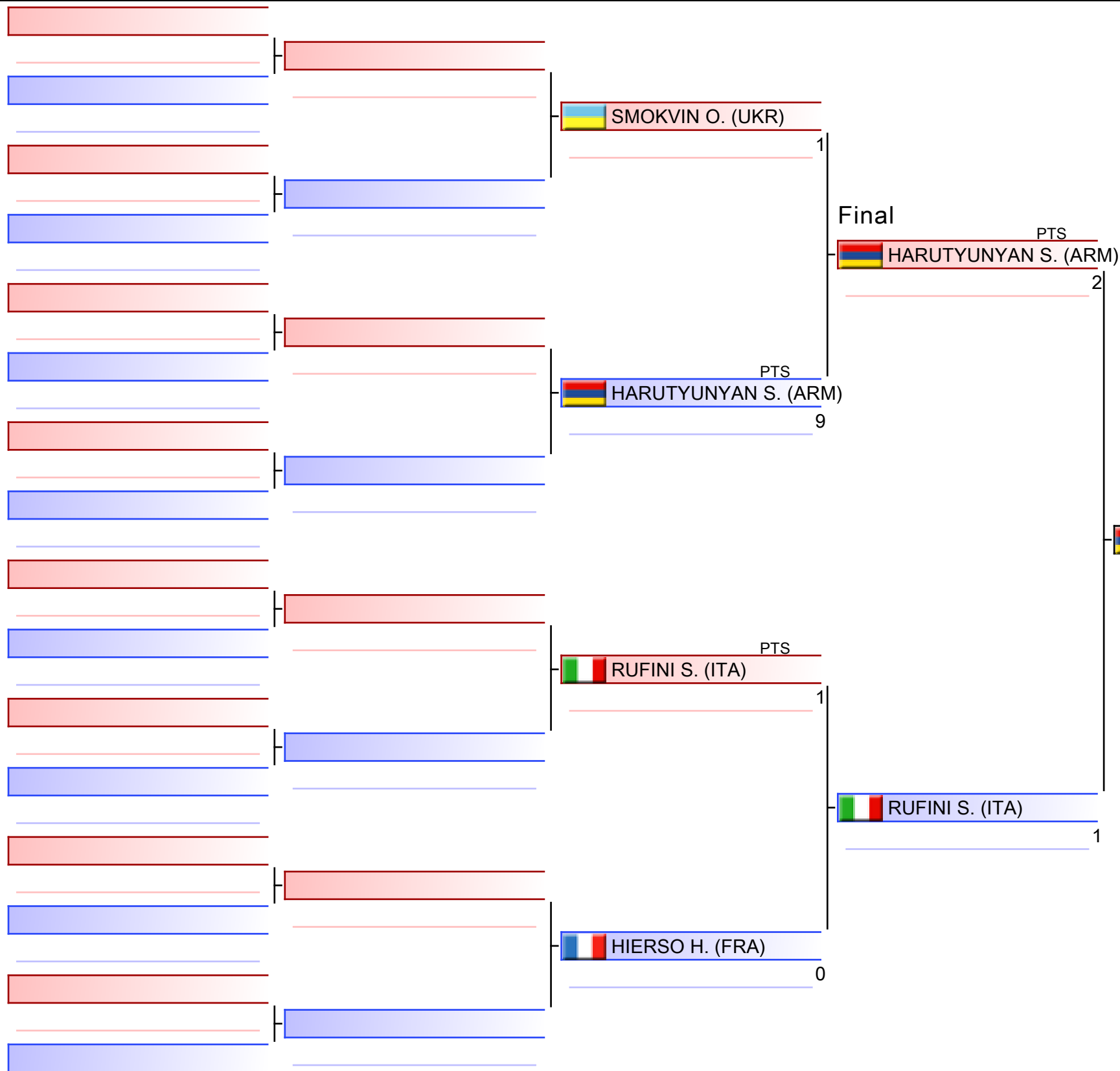

HARUTYUNYAN S. (ARM)

1.	HARUTYUNYAN SUREN (ARM)
2.	RUFINI SAMUELE (ITA)
3.	GONCALVES GUILHERME (POR)
3.	GANJZADEH MOHAMMAD-REZA (GER)
5.	SMOKVIN OLEKSANDR (UKR)
5.	HIERSO HAIRISS (FRA)
7.	TORRES STEVEN (SUI)
7.	ALVES RAFAEL (POR)

U21 Kumite Male -67 kg

Karate1 Youth League - Venice 2024

2024-12-04

Tatami
2 18:15

Pool
4,1,2,3

(c)sportdata GmbH & Co KG 2000-2024 (2024-12-08 20:16) v 10.2.0 build 1 (2024-11-20 00:58 CET) License: SDIL TVG (expire 2025-01-26)

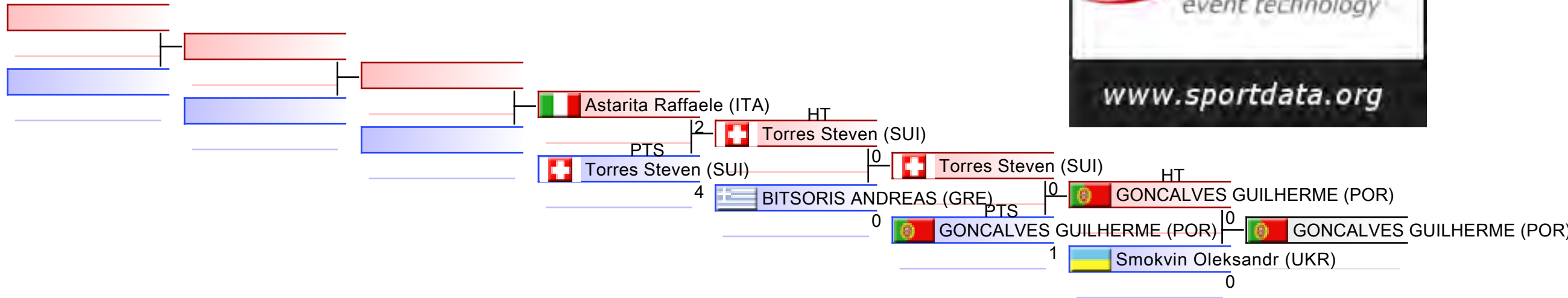

REPECHAGE: (4,1,2,3)

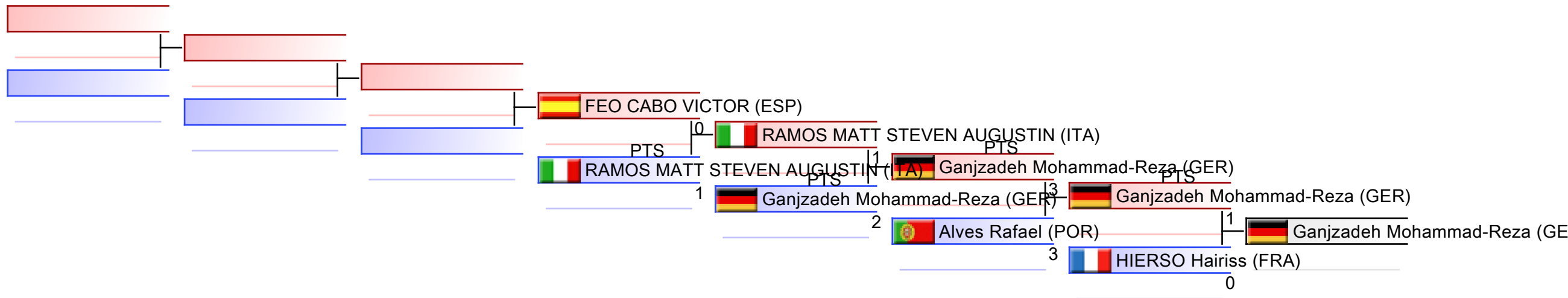



Karate1 Youth League - Venice 2024 - 2024-12-04



Official Results

U21 Kumite Male -67 kg (Entries: 82 Nations: 28)			
1	HARUTYUNYAN SUREN		ARM - ARMENIA
2	RUFINI SAMUELE		ITA - ITALY
3	GONCALVES GUILHERME		POR - PORTUGAL
3	GANJZADEH MOHAMMAD-REZA		GER - GERMANY
5	SMOKVIN OLEKSANDR		UKR - UKRAINE
5	HIERSO HAIRISS		FRA - FRANCE
7	TORRES STEVEN		SUI - SWITZERLAND
7	ALVES RAFAEL		POR - PORTUGAL
9	BITSORIS ANDREAS		GRE - GREECE
9	RAMOS MATT STEVEN AUGUSTIN		ITA - ITALY
11	ASTARITA RAFFAELE		ITA - ITALY
11	FEO CABO VICTOR		ESP - SPAIN

U21 KUMITE MALE -75 KG



Karate1 Youth League - Venice 2024

ENTRIES BY WEIGHT CATEGORY



U21 Kumite Male -75 kg
As of 8 DEC 2024

Country Code	ID	Gender	Name	Seeding
AZE	AZE02347	M	KARIMLI NIJAT	
AZE	AZE02549	M	SULEYMANOV RASHID	
BEL	BEL02440	M	PANZA ETHAN	
BEL	BEL02615	M	Roland Tom	
BEL		M	Yuksektepe Hamza	
BEL	BEL02794	M	Zekhnini Achraf	
BIH	BIH2455	M	Paljevac Sinan	
BIH		M	Šarić Loren	
BIH	BIH2823	M	Zolota Ismail	
BUL		M	Vakarelov Vladislav	
CRO	CRO2525	M	Milinovich David	
CRO	CRO2223	M	PRUSINA IVAN NIKO	
CRO		M	Šonje Dominik	
CYP	CYP2149	M	michael Alex	
CZE		M	Benda Karel	
CZE		M	Šnajdr Štěpán	
CZE	CZE02474	M	Štáhlavský Ondřej	
CZE		M	Tirala Radek	
EGY		M	Walid Abdelnaby Ahmed	
ENG	SD64200	M	Cooper-Dalley Joseph	
ENG		M	Dawson Idris	
ENG		M	Fedorov Boris	
ENG	ENG02769	M	Marshall Samuel	
ENG		M	Walker James	
ESP		M	FERNANDEZ PERIS SANTIAGO	
FRA	SD65740	M	Assemat Hugo	
FRA	FRA004246	M	MALCOIFFE KENZO	
FRA	FRA03464	M	NDAO Kemi	
FRA	FRA02859	M	NDAO Sassy	
GER	GER03147	M	Pfennig Maximilian	
GER		M	Tiili Ahmed Rayane	
GER	SD49448	M	Volpe Renzo	
GER	GER02742	M	Walger Philipp	
GRE	GRE02629	M	PAPADOPOULOS GEORGIOS	
HUN		M	Hegedus Robert	
HUN		M	Knirsch Patrik	
IRI	IRI03232	M	Torabi Mohammadreza	
ITA		M	ARMANO MANUELE	
ITA	ITA03619	M	Caleffi Alessio	
ITA	ITA04280	M	colonnese federico	
ITA	ITA03836	M	COPPOLA ALESSANDRO	
ITA		M	De Chirico Paolo	
ITA		M	De Simone Emanuele	
ITA	SD71701	M	Gallo Alessio	
ITA	SD61485	M	GIACOMELLI DANIELE	



Karate1 Youth League - Venice 2024

ENTRIES BY WEIGHT CATEGORY



U21 Kumite Male -75 kg
As of 8 DEC 2024

Country Code	ID	Gender	Name	Seeding
ITA	ITA03876	M	Iannuzzi Mario	
ITA	ITA04469	M	Marino ANGELO	
ITA		M	NAPOLI FRANCESCO	
ITA		M	Piscopo Loris	
ITA	ITA03027	M	RICCARDI VITTORIO	
ITA		M	Rizzati Thomas	
ITA	ITA04207	M	TORRE CRISTIAN	
ITA		M	Trefoloni Alessio	
ITA	ITA04236	M	Ungaretti Gabriele	
ITA		M	Ventrone Mattia	
KOS	KOS2192	M	SHAQIRI ARTIOL	
LAT	LAT02552	M	Fomkins Ilja	
LAT	LAT2083	M	Pētersons Kristiāns Anrī	
MDA	MDA02162	M	GRIGORASENCO NICHITA	
NED	NED02687	M	Boudewijns Dennis	
NED	NED02684	M	Franken Ricardo	
NED	NED2342	M	Teeffelen van Sebastiaan	
NED	NED02509	M	Van der Weide Niek	
NOR		M	Sælid Mads	
PER	SD68686	M	BACHOIR VEGA ANDRE LOUIS	
POL	POL3753	M	ROCHALSKI BRAJAN	
POL	POL3442	M	Róg Maciej	
POR	POR02396	M	FERNANDES BERNARDO PINEU LOPES	
POR	POR02479	M	Inacio Diogo	
POR		M	Martins Henrique	
POR		M	Moura Luís David	
POR		M	Neto Francisco Silva	
POR		M	Ribeiro Francisco	
SLO	SLO02685	M	BOZIC CENE	
SLO	SLO2443	M	ZIBRET BOR	
SRB		M	Đokić Filip	
SUI		M	Oberson Antoine	
SUI	SUI02267	M	Sanarica Niccolo	
SVK	SVK02343	M	Čiaky Martin	
SVK	SVK02626	M	Papp Zoltán	
TKM	TKM002690	M	SULEYMANOV RESUL	
UKR	UKR02531	M	Ovras Oleh	
UKR	UKR02528	M	PANCHUK ARTEM	
UKR	UKR02970	M	PIANTKIVSKYI DENYS	
UKR	UKR02683	M	Pitsul Heorhii	
UKR	UKR02443	M	SHVEDA VLADYSLAV	
USA	USA03698	M	Daswani Samuel	
VEN	VEN02381	M	Vivas JUAN DIEDO	

U21 Kumite Male -75 kg

Karate1 Youth League - Venice 2024, PALAZZO DEL TURISMO, Piazza Brescia 11, 30016 Lido di Jesolo VE, ITA

2024-12-04

Tatami
1 14:30

Pool
1/4

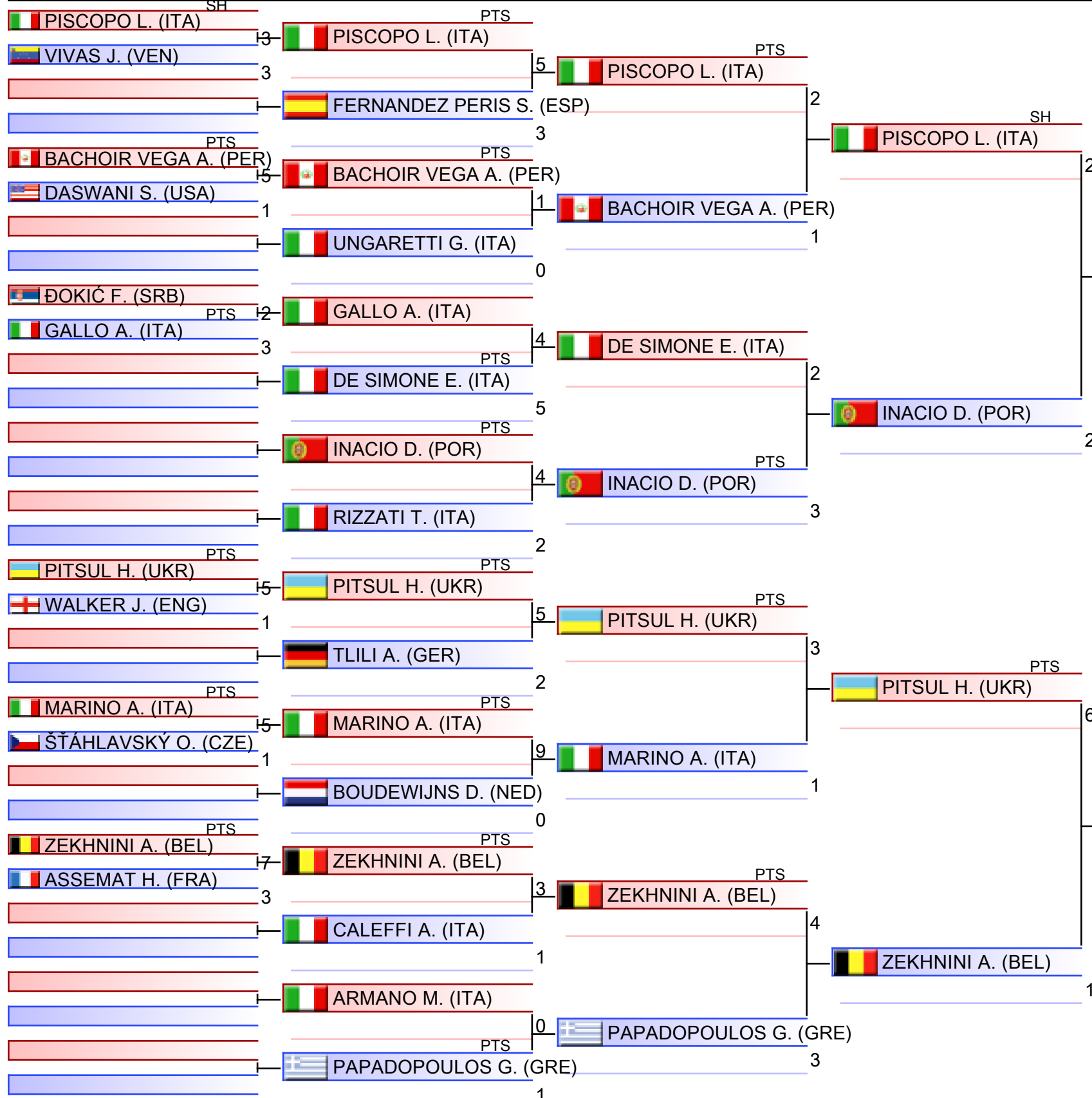

- | |
|-----------------------------------|
| 1. PITSUL HEORHII (UKR) |
| 2. TEEFFELEN VAN SEBASTIAAN (NED) |
| 3. OVRAS OLEH (UKR) |
| 3. WALKER JAMES (ENG) |
| 5. ZOLOTA ISMAIL (BIH) |
| 5. FRANKEN RICARDO (NED) |
| 7. COOPER-DALLEY JOSEPH (ENG) |
| 7. PISCOPO LORIS (ITA) |

U21 Kumite Male -75 kg

Karate1 Youth League - Venice 2024, PALAZZO DEL TURISMO, Piazza Brescia 11, 30016 Lido di Jesolo VE, ITA

2024-12-04

Tatami
2 14:30

Pool
2/4

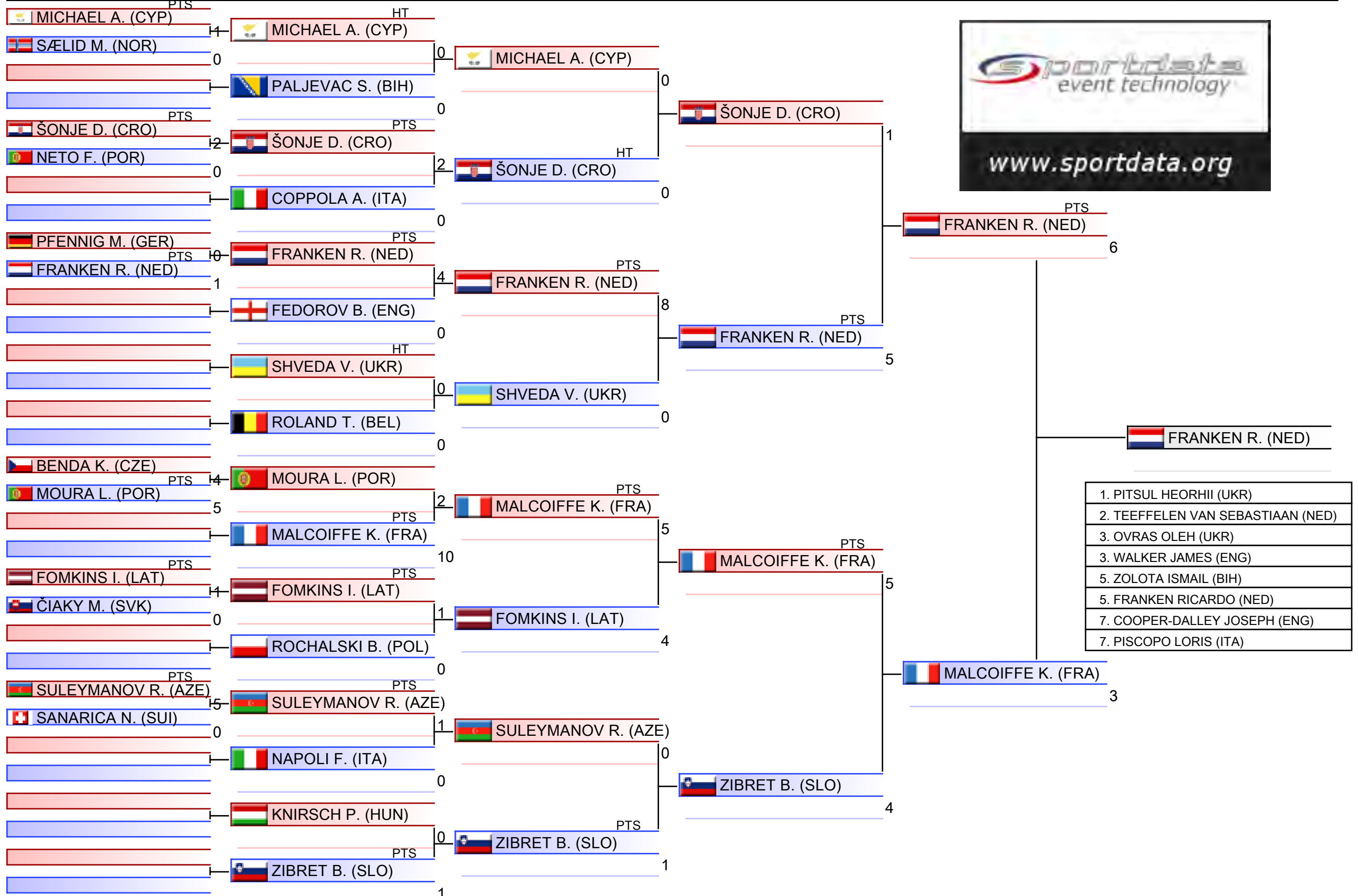

1.	PITSUL HEORHII (UKR)
2.	TEEFFELEN VAN SEBASTIAAN (NED)
3.	OVRAS OLEH (UKR)
3.	WALKER JAMES (ENG)
5.	ZOLOTA ISMAIL (BIH)
5.	FRANKEN RICARDO (NED)
7.	COOPER-DALLEY JOSEPH (ENG)
7.	PISCOPO LORIS (ITA)

U21 Kumite Male -75 kg

Karate1 Youth League - Venice 2024, PALAZZO DEL TURISMO, Piazza Brescia 11, 30016 Lido di Jesolo VE, ITA

2024-12-04

Tatami
3 14:30

Pool
3/4

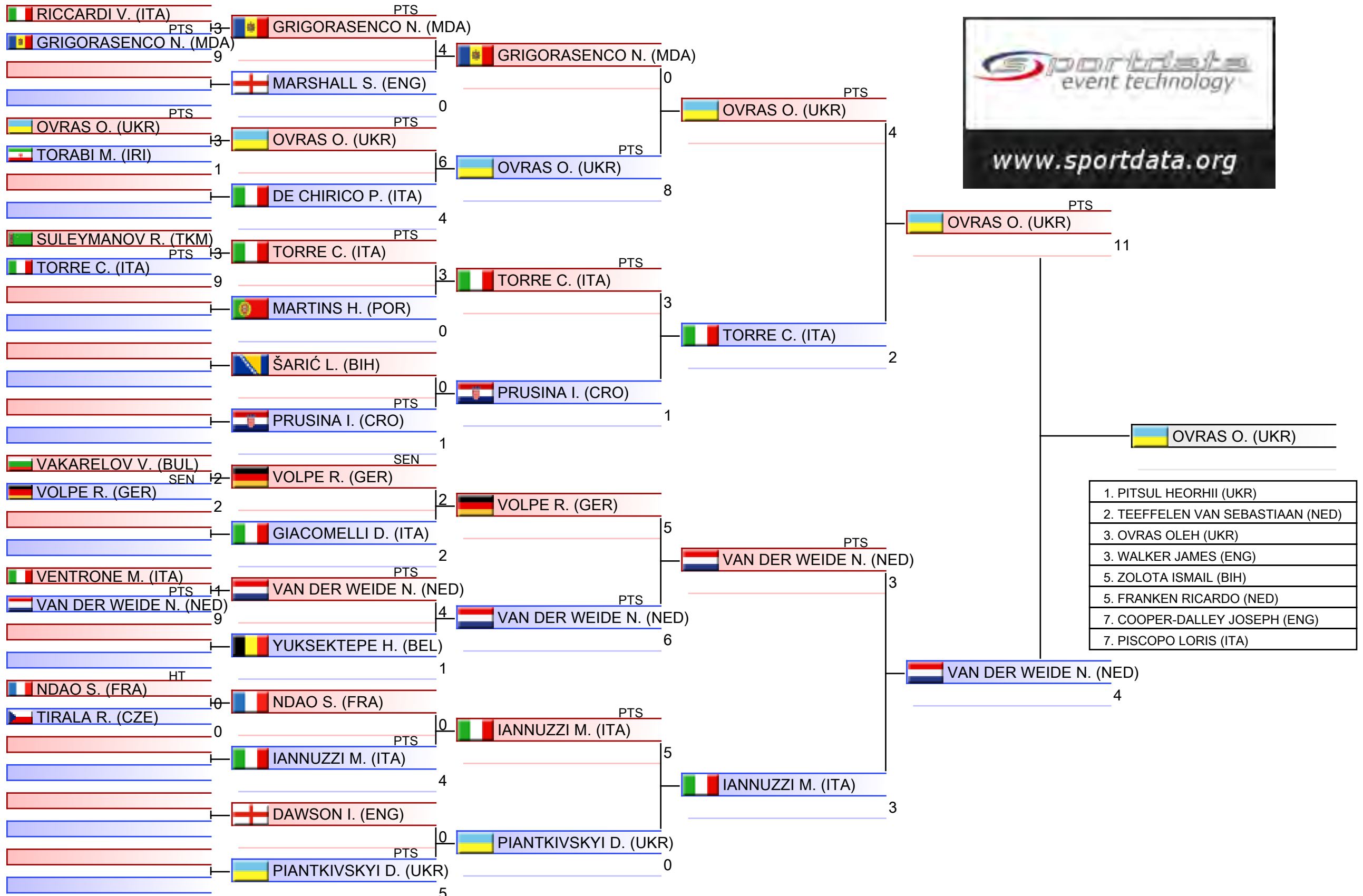

U21 Kumite Male -75 kg

Karate1 Youth League - Venice 2024, PALAZZO DEL TURISMO, Piazza Brescia 11, 30016 Lido di Jesolo VE, ITA

2024-12-04

Tatami
4 14:30

Pool
4/4

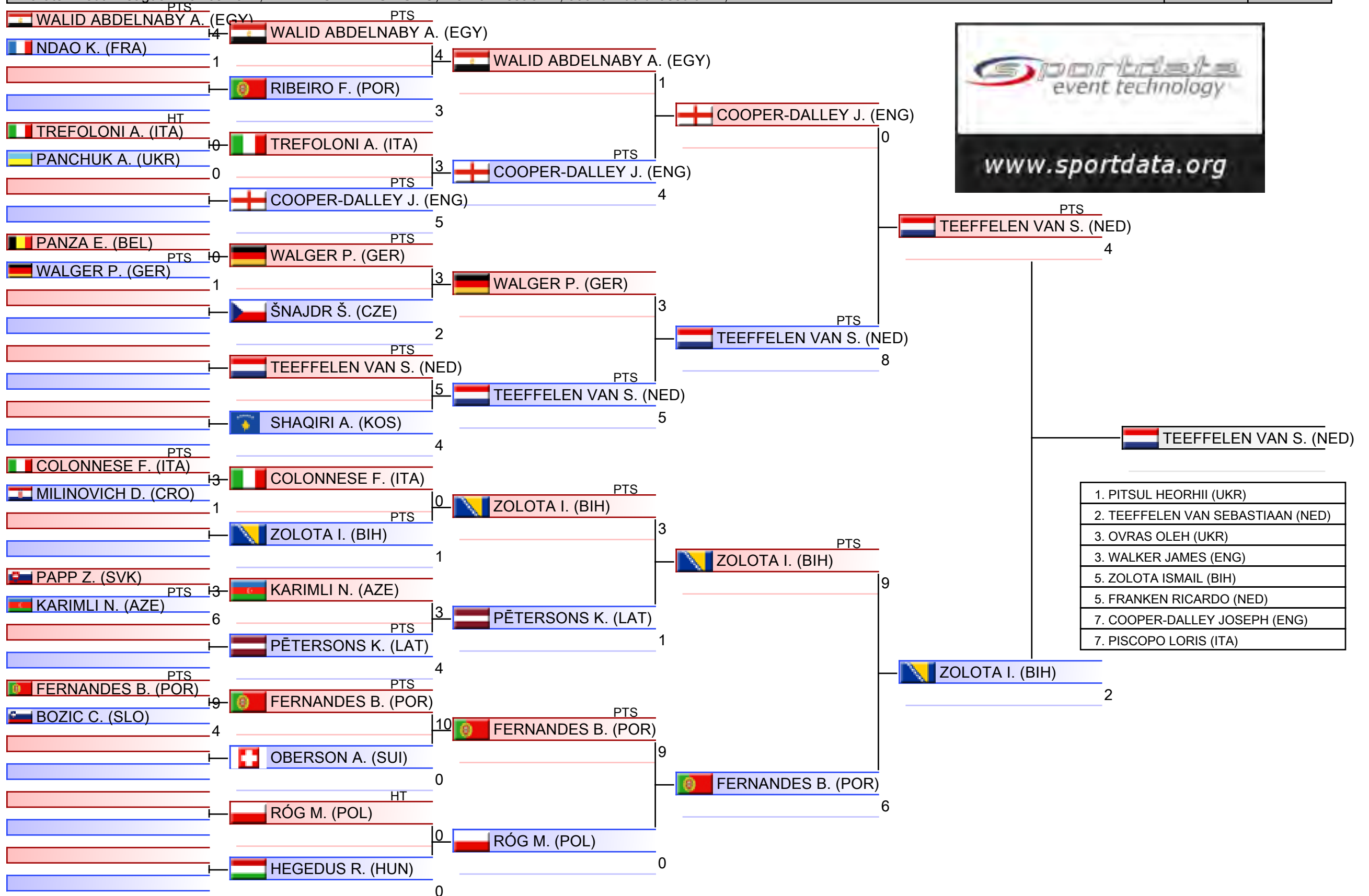

Pool winner-U21 Kumite Male -75 kg

Karate1 Youth League - Venice 2024, PALAZZO DEL TURISMO, Piazza Brescia 11, 30016 Lido di Jesolo VE, ITA

2024-12-04

Tatami

3 16:35

Pool

1/1

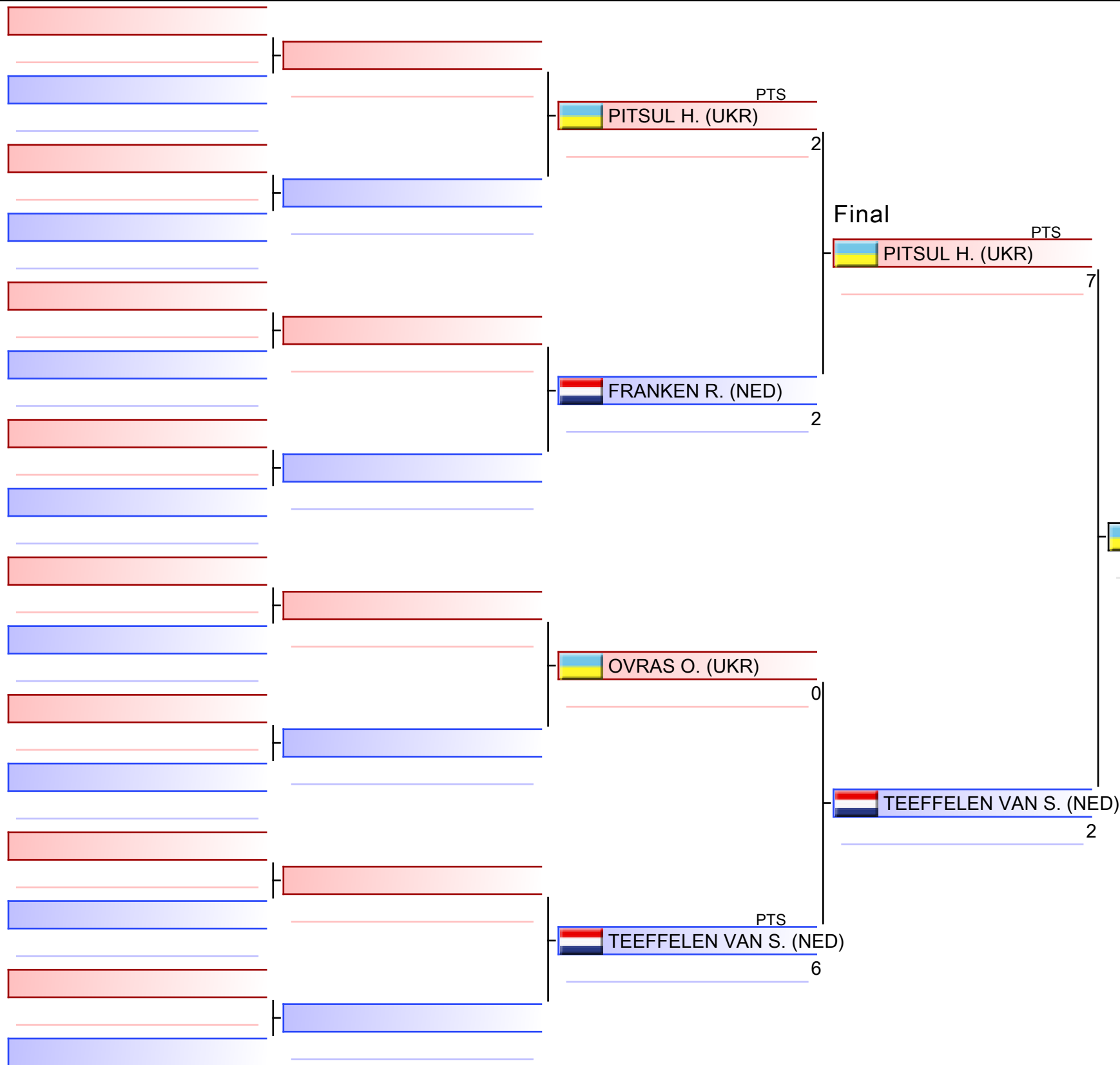

1. PITSUL HEORHII (UKR)
2. TEEFFELEN VAN SEBASTIAAN (NED)
3. OVRAS OLEH (UKR)
3. WALKER JAMES (ENG)
5. ZOLOTA ISMAIL (BIH)
5. FRANKEN RICARDO (NED)
7. COOPER-DALLEY JOSEPH (ENG)
7. PISCOPO LORIS (ITA)

U21 Kumite Male -75 kg

Karate1 Youth League - Venice 2024

2024-12-04

Tatami

3 18:15

Pool

1,2,3,4

(c)sportdata GmbH & Co KG 2000-2024 (2024-12-08 20:16) v 10.2.0 build 1 (2024-11-20 00:58 CET) License: SDIL TVG (expire 2025-01-26)

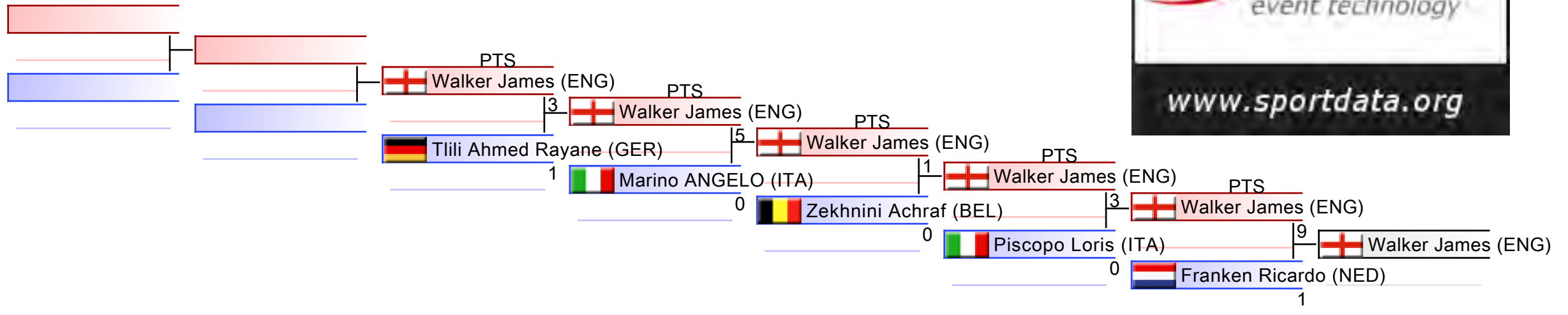

REPECHAGE: (1,2,3,4)

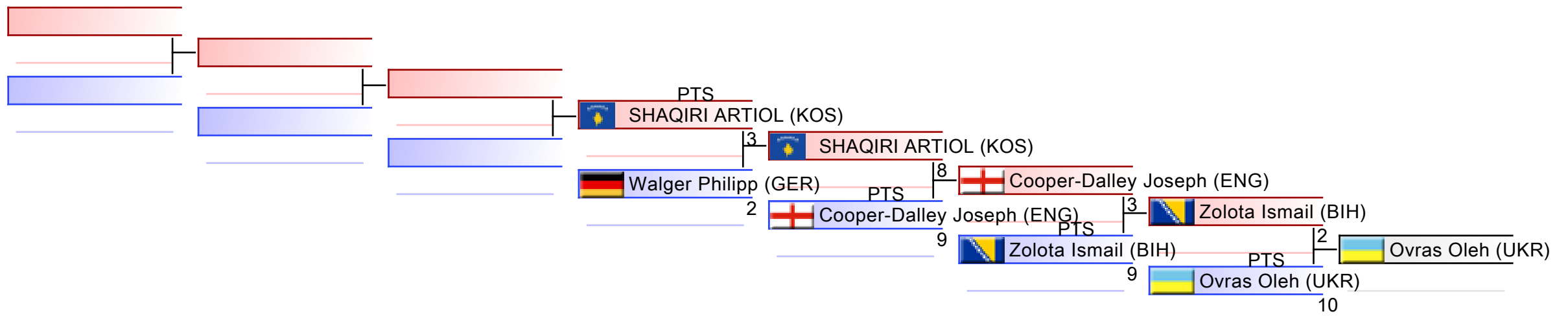



Karate1 Youth League - Venice 2024 - 2024-12-04



Official Results

U21 Kumite Male -75 kg (Entries: 88 Nations: 32)			
1	PITSUL HEORHII		UKR - UKRAINE
2	TEEFFELEN VAN SEBASTIAAN		NED - NETHERLANDS
3	OVRAS OLEH		UKR - UKRAINE
3	WALKER JAMES		ENG - ENGLAND
5	ZOLOTA ISMAIL		BIH - BOSNIA AND HERZEGOVINA
5	FRANKEN RICARDO		NED - NETHERLANDS
7	COOPER-DALLEY JOSEPH		ENG - ENGLAND
7	PISCOPO LORIS		ITA - ITALY
9	SHAQIRI ARTIOL		KOS - KOSOVO
9	ZEKHNINI ACHRAF		BEL - BELGIUM
11	WALGER PHILIPP		GER - GERMANY
11	MARINO ANGELO		ITA - ITALY
13	TLILI AHMED RAYANE		GER - GERMANY

U21 KUMITE MALE -84 KG



Karate1 Youth League - Venice 2024

ENTRIES BY WEIGHT CATEGORY



U21 Kumite Male -84 kg

As of 8 DEC 2024

Country Code	ID	Gender	Name	Seeding
AUT		M	Kleinekathöfer Jakob	
AUT	AUT02527	M	Kühnel Henrik	
BIH	BIH2817	M	Hodžić Amar	
BIH	BIH03434	M	Ivanic Mile	
BIH	BIH03435	M	Jovanović Luka MD	
BIH		M	Novicki Aleksandar	
CAN		M	Mabrouk Mohamed Younes	
CRO		M	Crnogaj Teo	
CRO		M	Nedić Leon	
CRO	CRO2122	M	TERHAJ IVAN	
CRO		M	VITELIĆ PAPRIKA TIBOR	
CYP	CYP2240	M	GENIAS NICOLAS	
CZE	CZE02475	M	SNIZEK JIRI	
CZE		M	Válek Vojtěch	
ENG	SD60796	M	Patrick Ashton	
GER	GER02806	M	Deutsch Pascal	
GER		M	Dommsch Louis	
GER	GER03144	M	Heinrich Adrian	
GER		M	Jendreizik Ole	
GRE	GRE02497	M	MATSOTAS ATHANASIOS	
GRE	GRE2183	M	Moraitis Nikolaos	
ISL	ISL2109	M	Halldórsson Hugi	
ITA	ITA03618	M	BOZZI ANDREA	
ITA	ITA04429	M	Del Seppia PIETRO	
ITA	ITA04430	M	DOVERA GABRIELE	
ITA		M	Ileshaj gabriele	
ITA	ITA03635	M	LUCIANI DAVIDE	
ITA		M	Pezzei Fabian	
ITA	ITA02898	M	PEZZOTTI GABRIELE	
ITA	ITA03076	M	Rossini Gabriele	
ITA	ITA03807	M	Sacco Gabriele	
ITA		M	SALVATI ADRIANO	
ITA	ITA03019	M	ZAPPONE ANTONIO	
KAZ	KAZ02648	M	Myrzaly Zhansultan	
LUX		M	Almalh Mahmoud	
MKD		M	BOZOVIC DANILO	
MNE		M	DURUTOVIĆ ĐORĐE	
MNE	MNE2287	M	Jovović Lazar	
POR	SD65457	M	Seco João	
ROU	ROU2475	M	COSTACHE LUIS ANDREI	
ROU	ROU02698	M	RADULESCU STEFAN	
SCO	SCO02405	M	Furness Cameron	
SVK	SVK02501	M	Sečkár Šimon	
SWE	SWE02427	M	HAAG OZZY	
TPE	TPE02730	M	LEE WEN-SHENG	



Karate1 Youth League - Venice 2024
ENTRIES BY WEIGHT CATEGORY



U21 Kumite Male -84 kg
As of 8 DEC 2024

Country Code	ID	Gender	Name	Seeding
TUR		M	aydemir süleyman	
UKR	UKR03076	M	Herus Oleh	
UKR	UKR02879	M	Kosarych Andrii	
UKR	UKR02451	M	Kozachok Oleksandr	
VEN	VEN2323	M	BELISARIO GONZÁLEZ CARLOS EDUARDO	

U21 Kumite Male -84 kg

Karate1 Youth League - Venice 2024, PALAZZO DEL TURISMO, Piazza Brescia 11, 30016 Lido di Jesolo VE, ITA

2024-12-05

Tatami
5 12:40

Pool
1/4

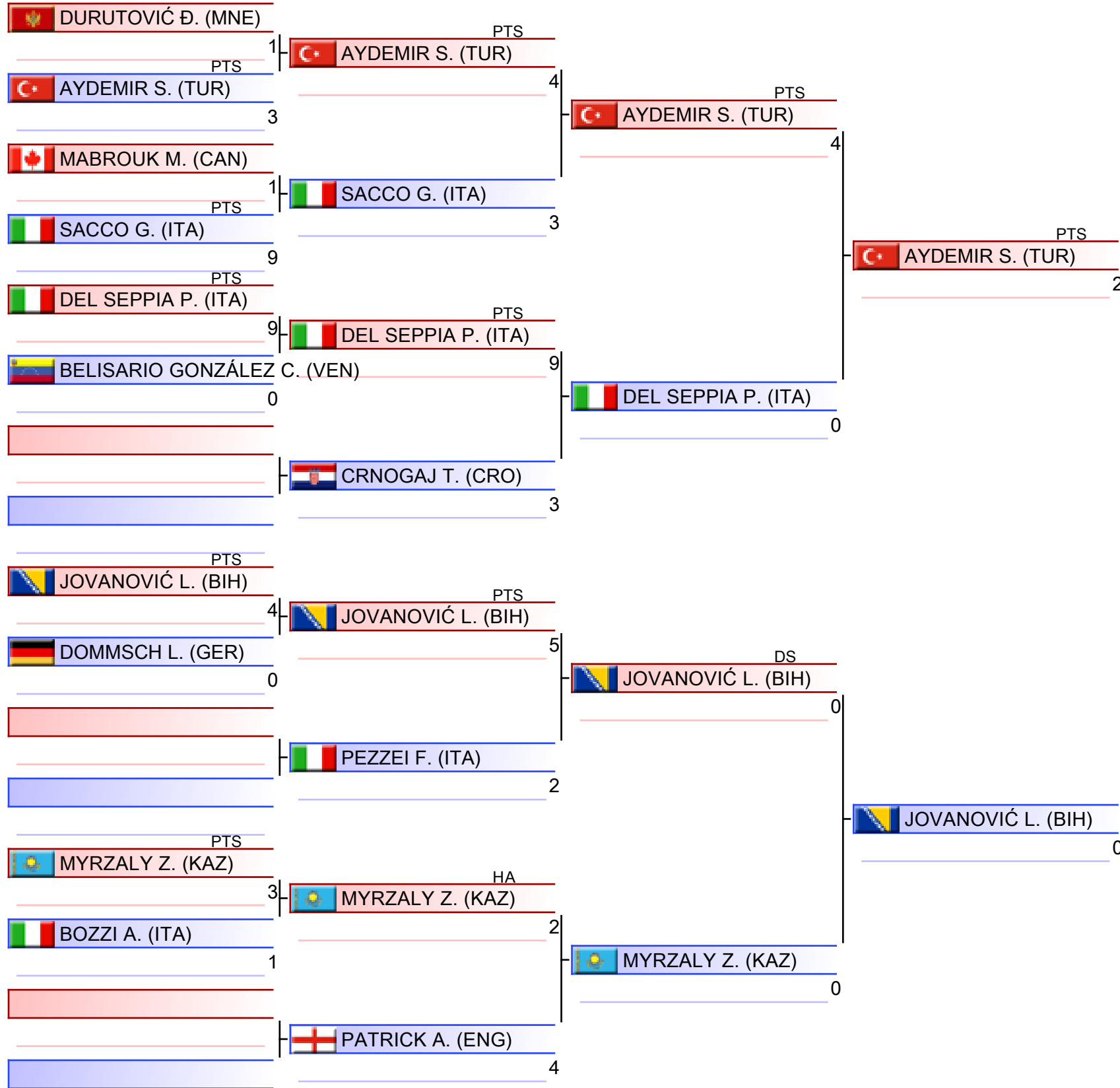

1. PEZZOTTI GABRIELE (ITA)
2. SEČKÁR ŠIMON (SVK)
3. JOVOVIĆ LAZAR (MNE)
3. MORAITIS NIKOLAOS (GRE)
5. HAAG OZZY (SWE)
5. AYDEMIR SÜLEYMAN (TUR)
7. HEINRICH ADRIAN (GER)
7. HERUS OLEH (UKR)

U21 Kumite Male -84 kg

Karate1 Youth League - Venice 2024, PALAZZO DEL TURISMO, Piazza Brescia 11, 30016 Lido di Jesolo VE, ITA

2024-12-05

Tatami
6 12:40

Pool
2/4

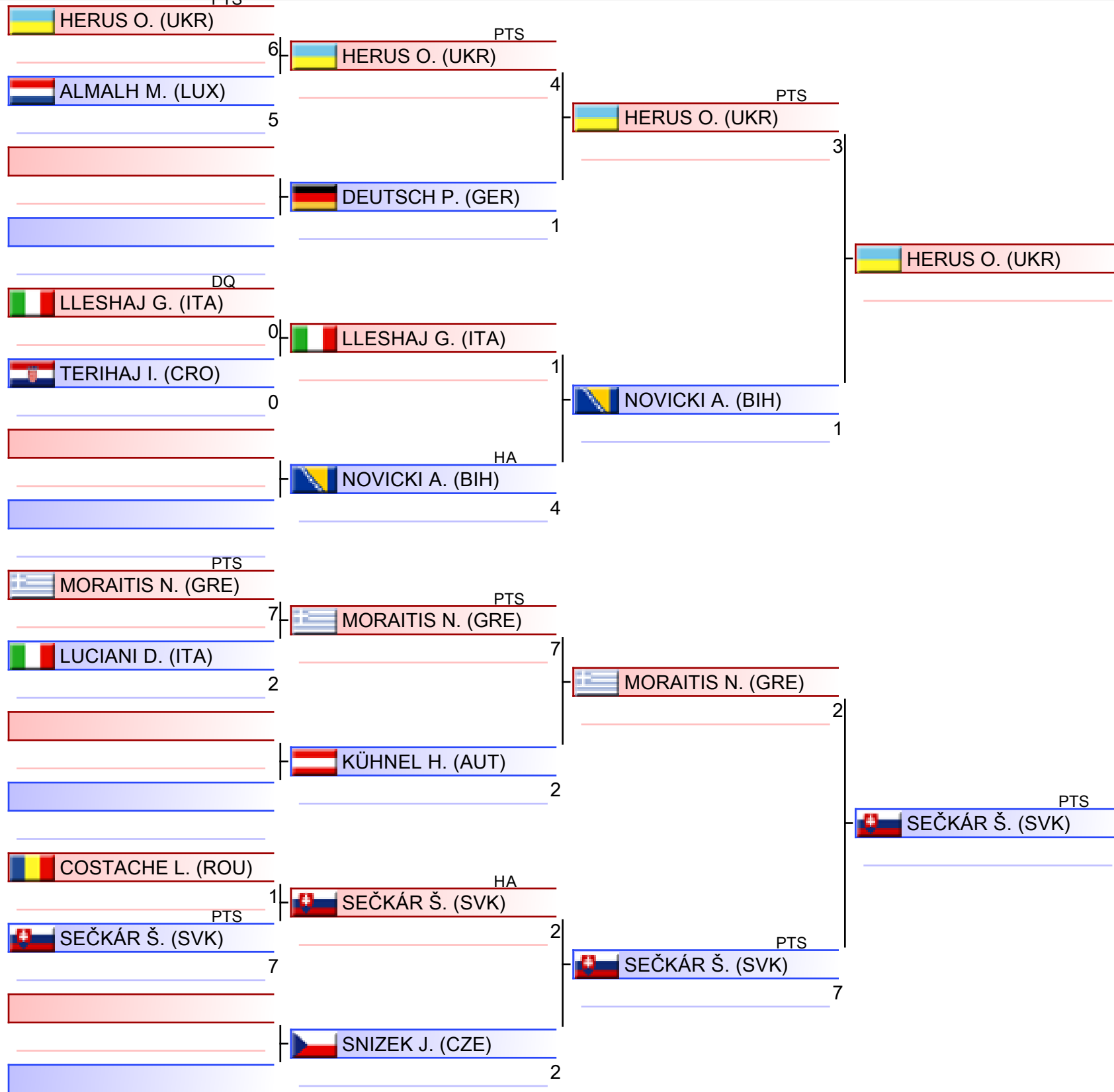

SEČKÁR Š. (SVK)

1. PEZZOTTI GABRIELE (ITA)
2. SEČKÁR ŠIMON (SVK)
3. JOVOVIĆ LAZAR (MNE)
3. MORAITIS NIKOLAOS (GRE)
5. HAAG OZZY (SWE)
5. AYDEMIR SÜLEYMAN (TUR)
7. HEINRICH ADRIAN (GER)
7. HERUS OLEH (UKR)

U21 Kumite Male -84 kg

Karate1 Youth League - Venice 2024, PALAZZO DEL TURISMO, Piazza Brescia 11, 30016 Lido di Jesolo VE, ITA

2024-12-05

Tatami
7 12:40

Pool
3/4

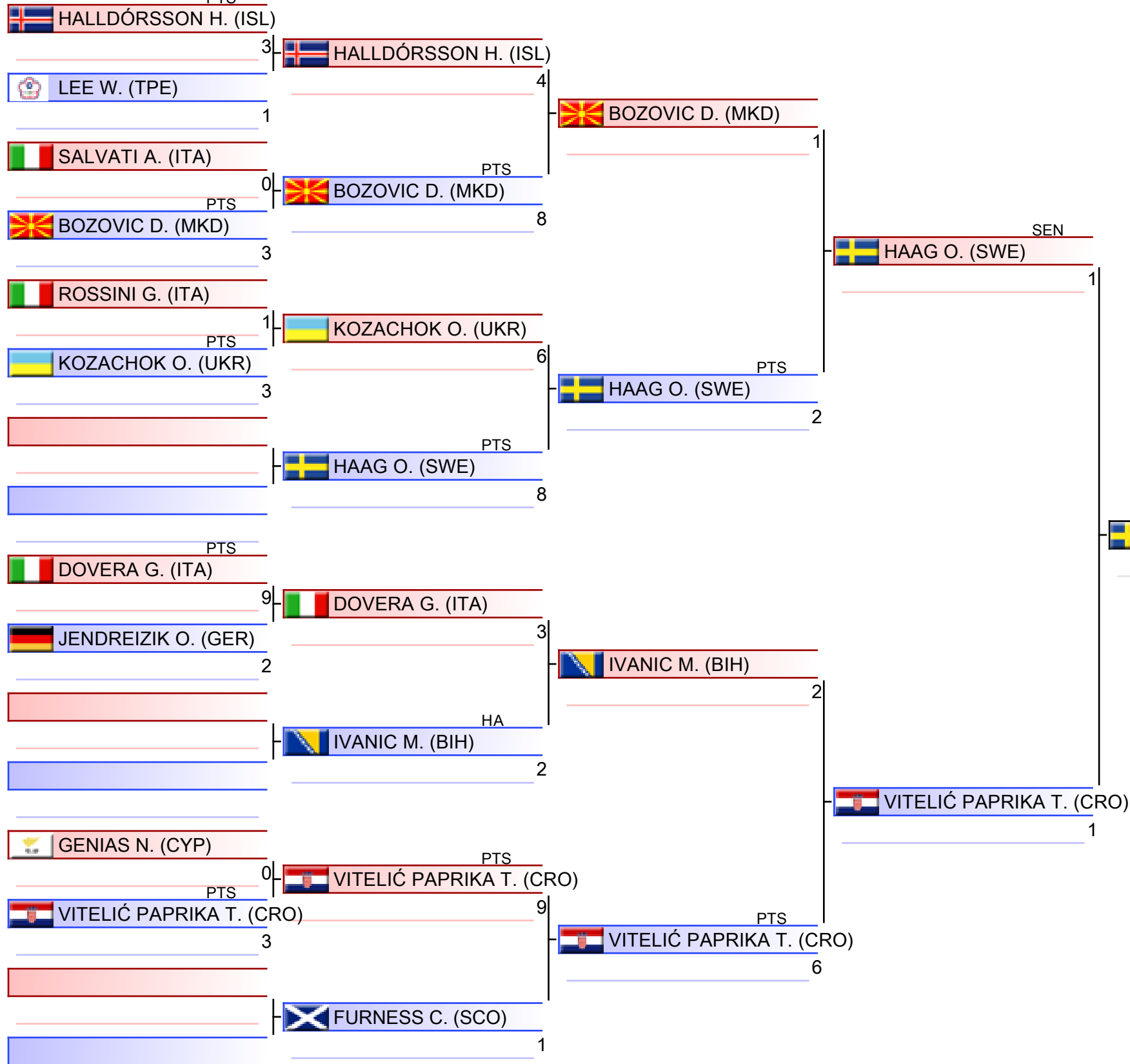

1. PEZZOTTI GABRIELE (ITA)
2. SEČKÁR ŠIMON (SVK)
3. JOVOVIĆ LAZAR (MNE)
3. MORAITIS NIKOLAOS (GRE)
5. HAAG OZZY (SWE)
5. AYDEMIR SÜLEYMAN (TUR)
7. HEINRICH ADRIAN (GER)
7. HERUS OLEH (UKR)

Pool winner-U21 Kumite Male -84 kg

Karate1 Youth League - Venice 2024, PALAZZO DEL TURISMO, Piazza Brescia 11, 30016 Lido di Jesolo VE, ITA

2024-12-05

Tatami
7 14:00

Pool
1/1

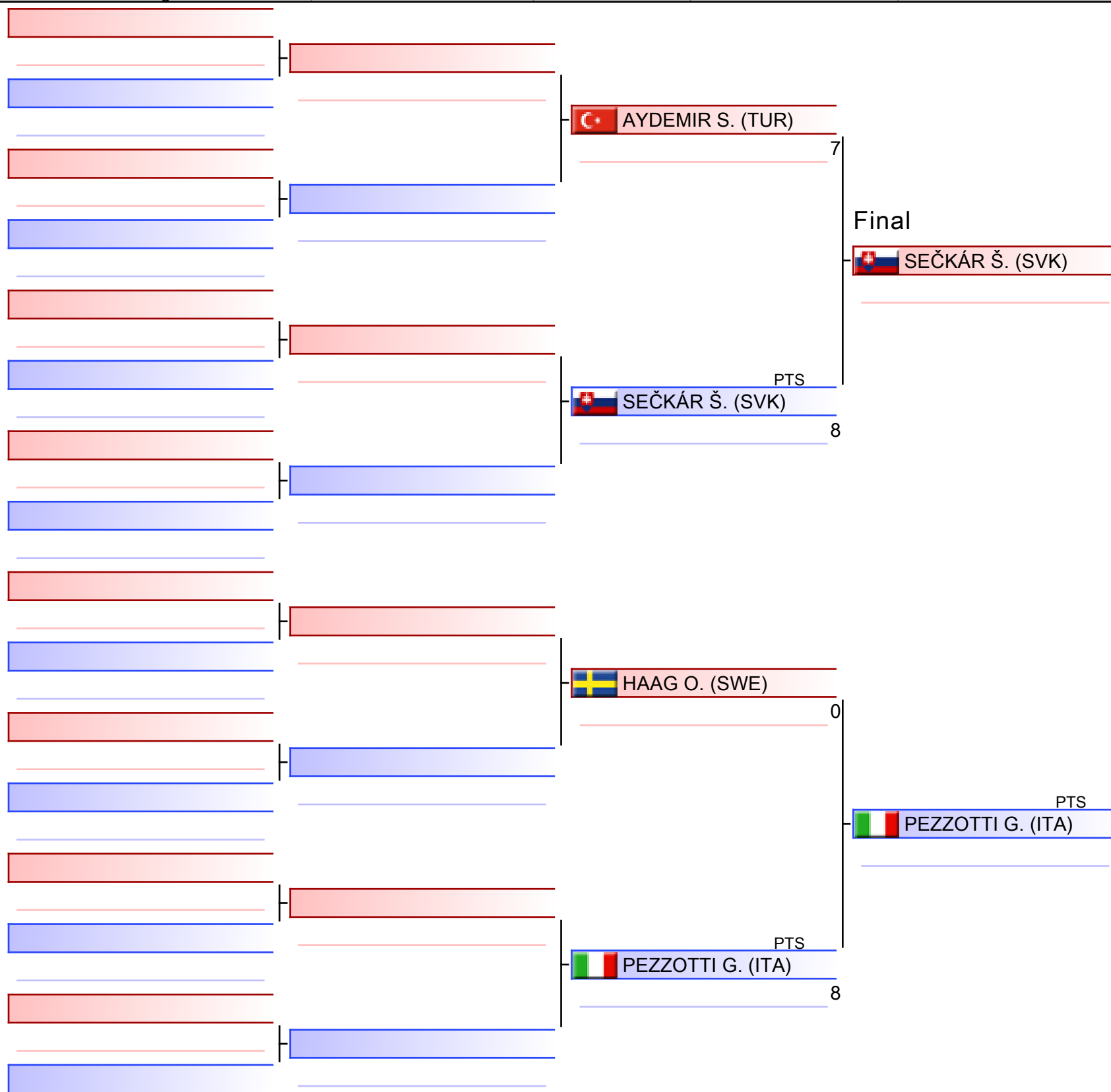

1. PEZZOTTI GABRIELE (ITA)
2. SEČKÁR ŠIMON (SVK)
3. JOVOVIĆ LAZAR (MNE)
3. MORAITIS NIKOLAOS (GRE)
5. HAAG OZZY (SWE)
5. AYDEMIR SÜLEYMAN (TUR)
7. HEINRICH ADRIAN (GER)
7. HERUS OLEH (UKR)

U21 Kumite Male -84 kg

Karate1 Youth League - Venice 2024

2024-12-05

Tatami

3 14:55

Pool

1,2,3,4

(c)sportdata GmbH & Co KG 2000-2024 (2024-12-08 20:16) v 10.2.0 build 1 (2024-11-20 00:58 CET) License: SDIL TVG (expire 2025-01-26)

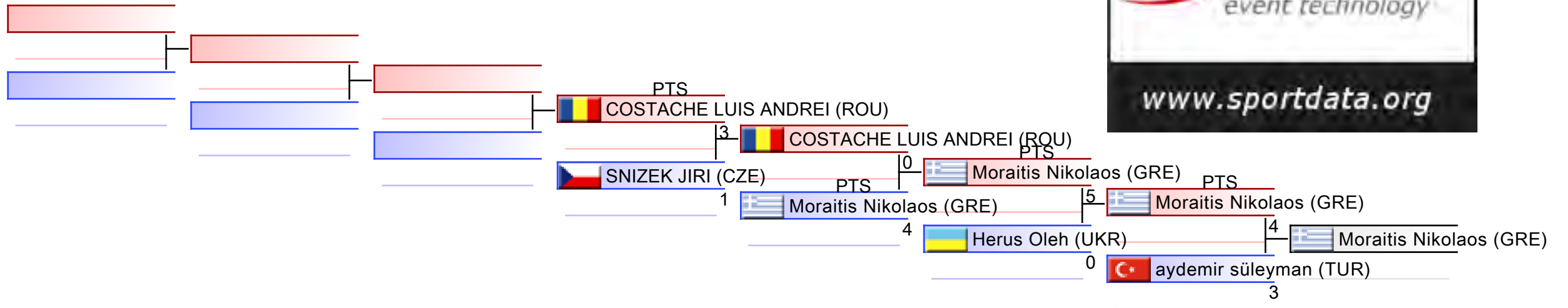

REPECHAGE: (1,2,3,4)

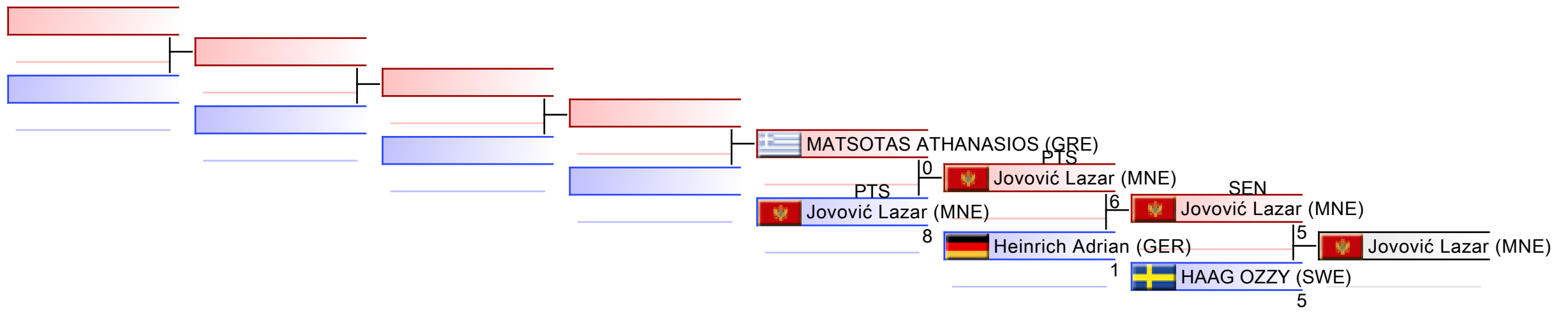



Karate1 Youth League - Venice 2024 - 2024-12-04



Official Results

U21 Kumite Male -84 kg (Entries: 50 Nations: 24)			
1	PEZZOTTI GABRIELE		ITA - ITALY
2	SEČKÁR ŠIMON		SVK - SLOVAKIA
3	JOVOVIĆ LAZAR		MNE - MONTENEGRO
3	MORAITIS NIKOLAOS		GRE - GREECE
5	HAAG OZZY		SWE - SWEDEN
5	AYDEMİR SÜLEYMAN		TUR - TURKIYE
7	HEINRICH ADRIAN		GER - GERMANY
7	HERUS OLEH		UKR - UKRAINE
9	MATSOTAS ATHANASIOS		GRE - GREECE
9	COSTACHE LUIS ANDREI		ROU - ROMANIA
11	SNIZEK JIRI		CZE - CZECH REPUBLIC

U21 KUMITE MALE 84+ KG



Karate1 Youth League - Venice 2024

ENTRIES BY WEIGHT CATEGORY



U21 Kumite Male 84+ kg

As of 8 DEC 2024

Country Code	ID	Gender	Name	Seeding
AUT	AUT02530	M	Kleinekathöfer Vincent	
AZE	AZE02554	M	KARIMZADA NIHAD	
BEL	BEL02580	M	JADOUL ERWAN	
BIH	BIH2179	M	Bostandzic Anes	
BIH		M	Pipal Tony	
BIH		M	Tanović Anel	
CRO	CRO03057	M	CUTURA TONI	
CRO	CRO2872	M	GONDI NIKOLA	
CRO	CRO03130	M	Plesivcak Mislav	
CRO	CRO03587	M	Zelenika Matko	
CZE		M	Endršt Jiří	
ENG	ENG02892	M	Darboe Bakary	
ESP		M	Echevarría Lavín Manuel	
FRA		M	AKGUN Ilhan	
FRA		M	Kanga Kertiss	
GER		M	Sejfic Sefo	
GER	GER03153	M	Sekot Nikolai	
HUN		M	Freund Péter	
ITA		M	confuorto umberto	
ITA	ITA04686	M	MAGNELLI EMANUELE	
ITA		M	Marino Fernando	
ITA		M	Martellini Nicholas	
ITA	ITA04530	M	Monego Edoardo	
ITA	ITA03648	M	Rosciglioni Jonathan	
ITA		M	SANTAMATO ROBERTO	
KUW	KUW003018	M	ALMURJAN ABDULAZIZ	
LUX		M	Davies Alexander	
MKD	MKD2637	M	Stojanovikj Stefan	
MNE		M	BJELIĆ DUŠAN	
NED	NED02682	M	van Woudenberg Mika	
POL	POL2991	M	KIRYLUK PAWEL	
ROU	ROU03089	M	VASILE DAVID GABRIEL	
SLO	SLO2417	M	KRZISNIK GAL	
SVK	SVK2301	M	Kešefák Dominik	
TPE	TPE02805	M	LI JIN-HAN	
TUR		M	kaya melih	
UKR		M	Hulin Nikita	
UKR	UKR02689	M	KASIANOV DANIIL	
UKR	UKR02868	M	Kozyljan Oleksandr	
UKR	UKR03053	M	USHAKOV YURIY	

U21 Kumite Male 84+ kg

Karate1 Youth League - Venice 2024, PALAZZO DEL TURISMO, Piazza Brescia 11, 30016 Lido di Jesolo VE, ITA

2024-12-05

Tatami
1 13:40

Pool
1/4

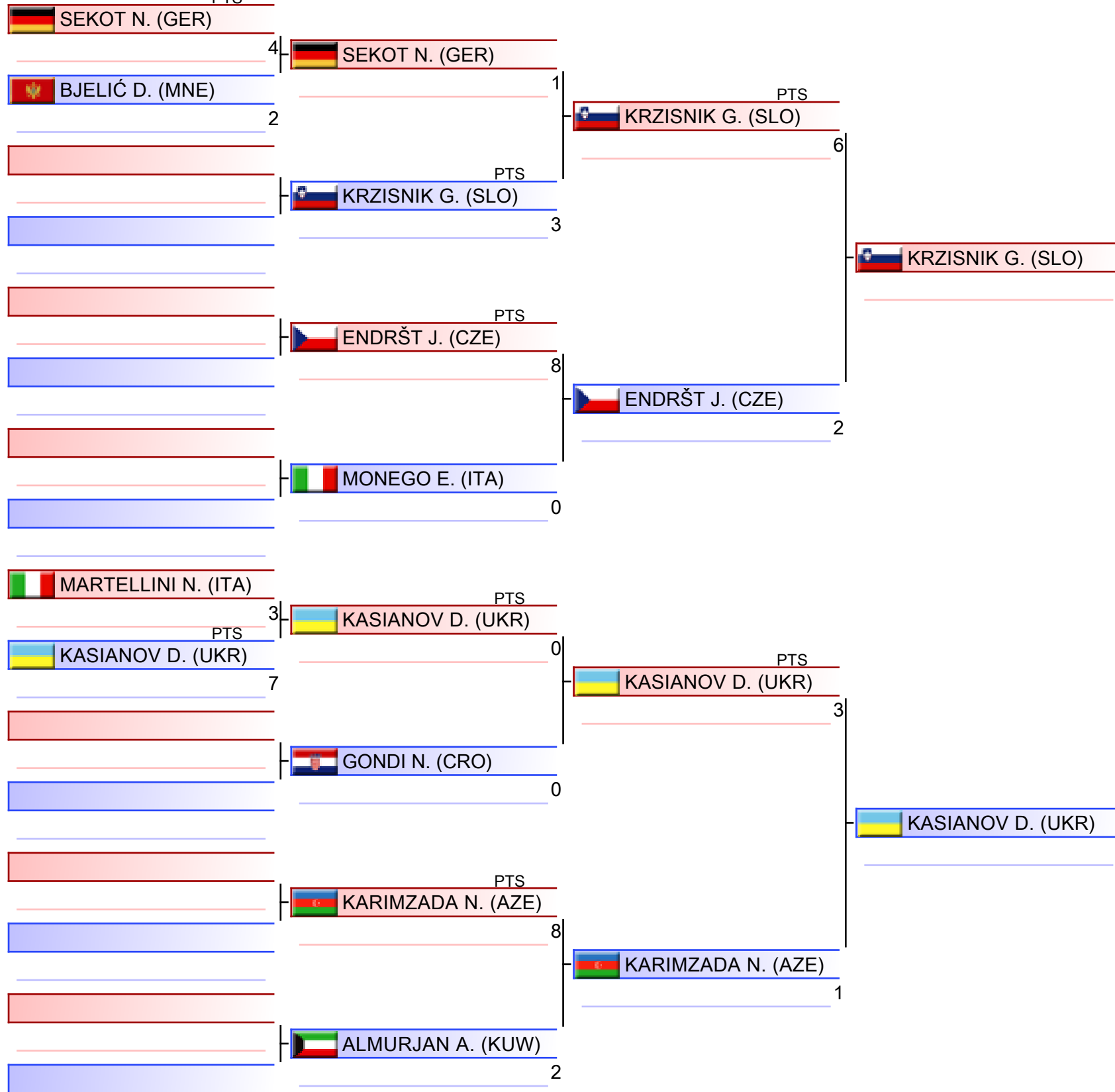

1. STOJANOVIKJ STEFAN (MKD)
2. KOZYLIAN OLEKSANDR (UKR)
3. KASIANOV DANIIL (UKR)
3. MARINO FERNANDO (ITA)
5. DAVIES ALEXANDER (LUX)
5. HULIN NIKITA (UKR)
7. ROSCIGLIONI JONATHAN (ITA)
7. JADOUL ERWAN (BEL)

U21 Kumite Male 84+ kg

Karate1 Youth League - Venice 2024, PALAZZO DEL TURISMO, Piazza Brescia 11, 30016 Lido di Jesolo VE, ITA

2024-12-05

Tatami
2 13:40

Pool
2/4

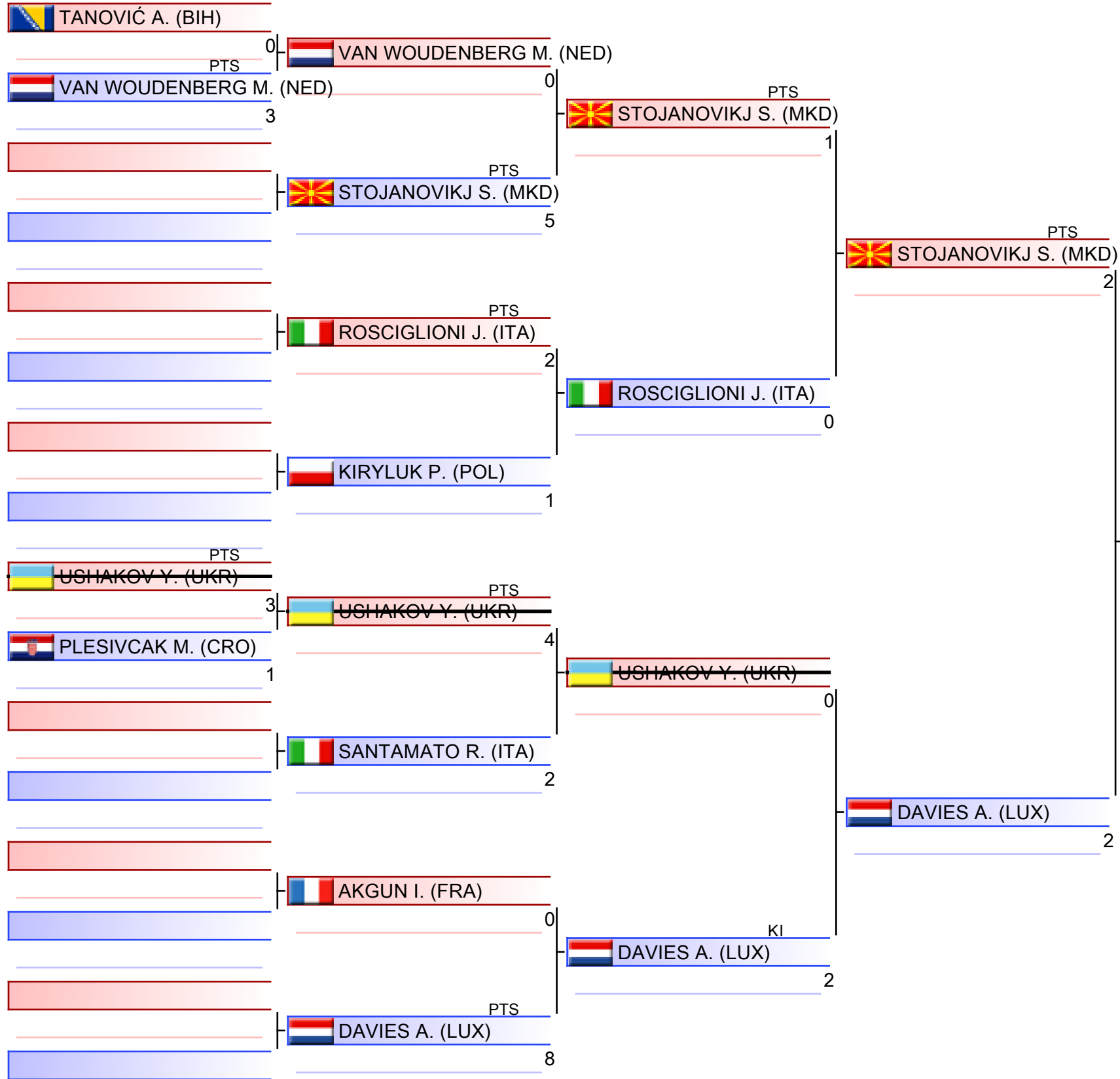

1. STOJANOVIKJ STEFAN (MKD)
2. KOZYLIAN OLEKSANDR (UKR)
3. KASIANOV DANIIL (UKR)
3. MARINO FERNANDO (ITA)
5. DAVIES ALEXANDER (LUX)
5. HULIN NIKITA (UKR)
7. ROSCIGLIONI JONATHAN (ITA)
7. JADOUL ERWAN (BEL)

U21 Kumite Male 84+ kg

Karate1 Youth League - Venice 2024, PALAZZO DEL TURISMO, Piazza Brescia 11, 30016 Lido di Jesolo VE, ITA

2024-12-05

Tatami
4 13:40

Pool
4/4

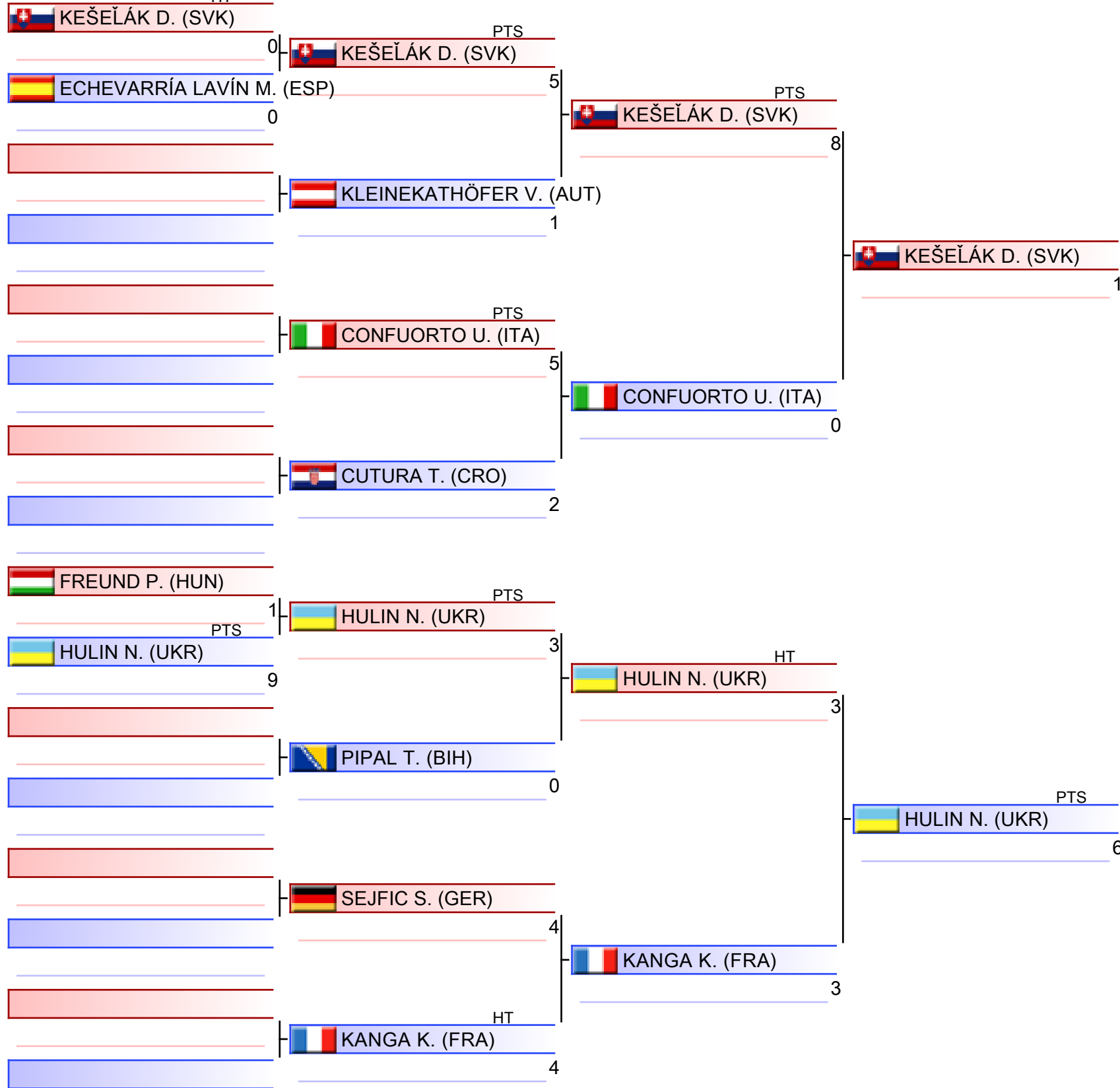

1. STOJANOVIKJ STEFAN (MKD)
2. KOZYLIAN OLEKSANDR (UKR)
3. KASIANOV DANIIL (UKR)
3. MARINO FERNANDO (ITA)
5. DAVIES ALEXANDER (LUX)
5. HULIN NIKITA (UKR)
7. ROSCIGLIONI JONATHAN (ITA)
7. JADOUL ERWAN (BEL)

Pool winner-U21 Kumite Male 84+ kg

Karate1 Youth League - Venice 2024, PALAZZO DEL TURISMO, Piazza Brescia 11, 30016 Lido di Jesolo VE, ITA

2024-12-05

Tatami
3 14:45

Pool
1/1

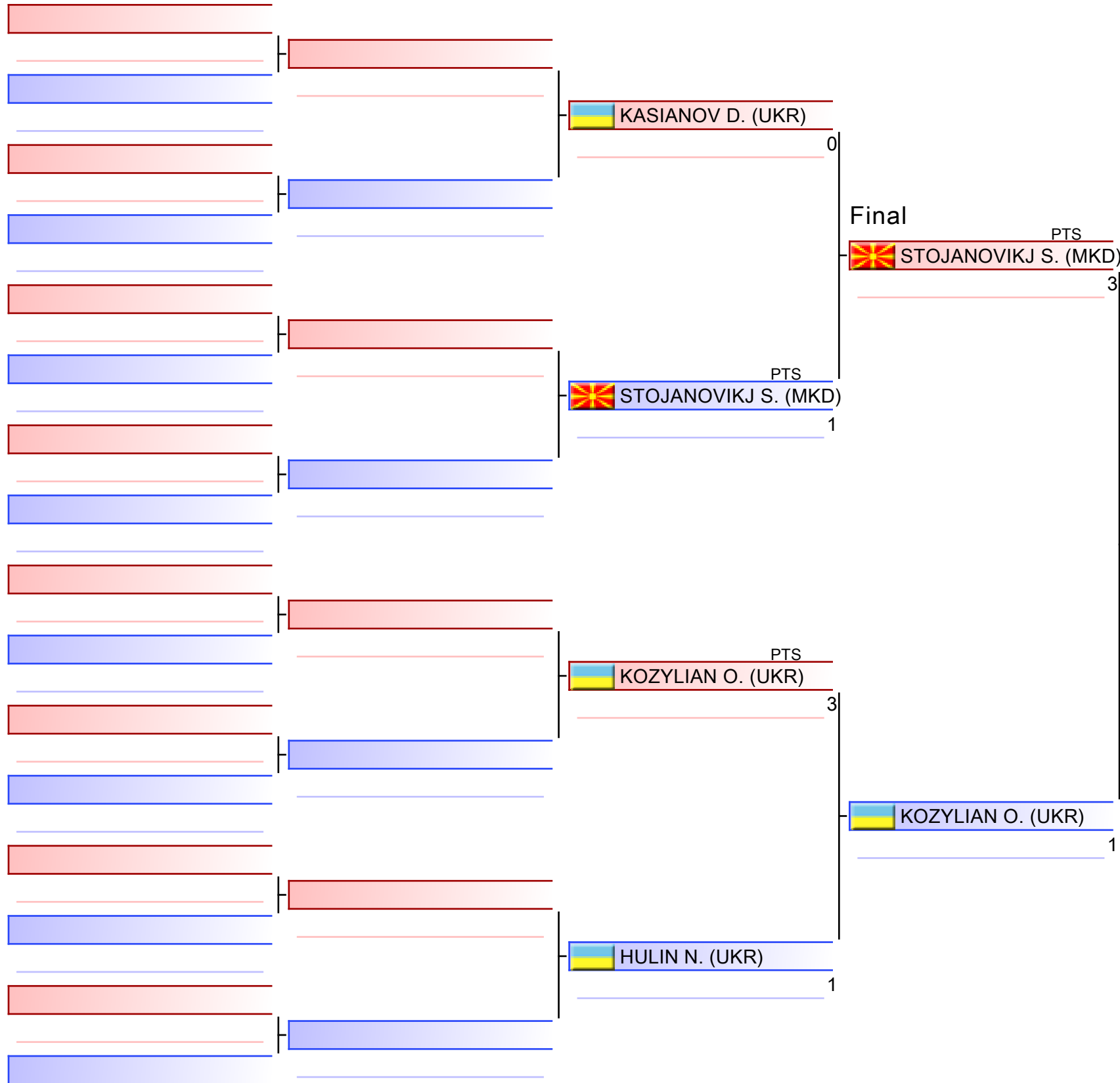

STOJANOVIKJ S. (MKD)

1. STOJANOVIKJ STEFAN (MKD)
2. KOZYLIAN OLEKSANDR (UKR)
3. KASIANOV DANIL (UKR)
3. MARINO FERNANDO (ITA)
5. DAVIES ALEXANDER (LUX)
5. HULIN NIKITA (UKR)
7. ROSCIGLIONI JONATHAN (ITA)
7. JADOUL ERWAN (BEL)

U21 Kumite Male 84+ kg

Karate1 Youth League - Venice 2024

2024-12-05

Tatami
1 14:55

Pool
1,2

(c)sportdata GmbH & Co KG 2000-2024 (2024-12-08 20:16) v 10.2.0 build 1 (2024-11-20 00:58 CET) License: SDIL TVG (expire 2025-01-26)

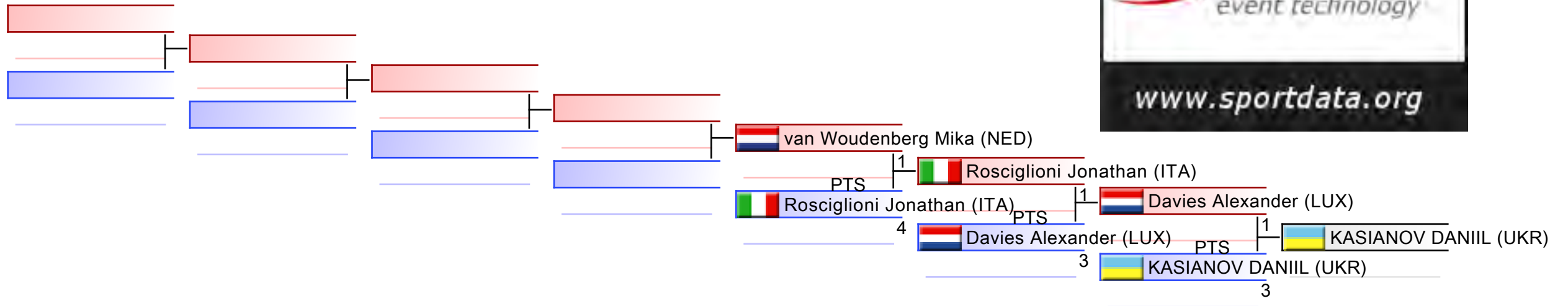

REPECHAGE: (1,2)

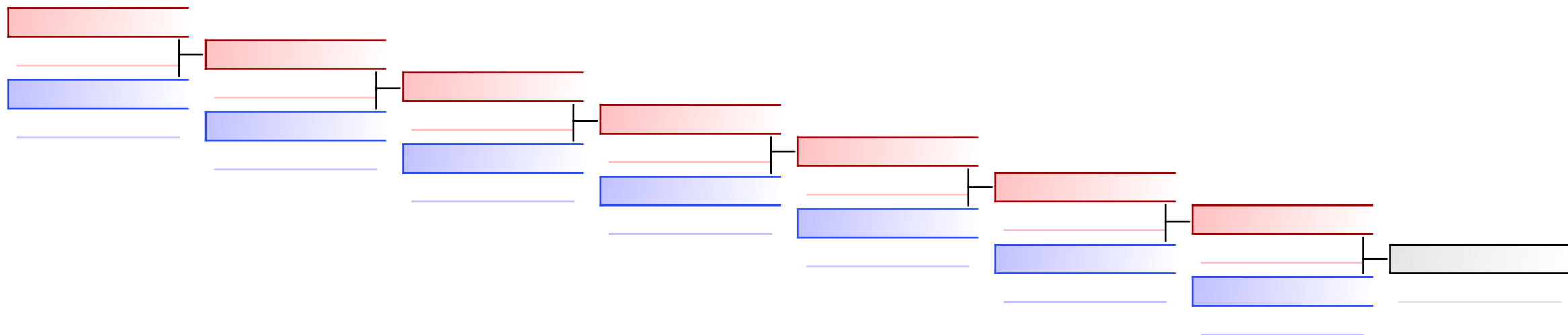

U21 Kumite Male 84+ kg

Karate1 Youth League - Venice 2024

2024-12-05

Tatami

2 14:55

Pool

3,4

(c)sportdata GmbH & Co KG 2000-2024 (2024-12-08 20:16) v 10.2.0 build 1 (2024-11-20 00:58 CET) License: SDIL TVG (expire 2025-01-26)

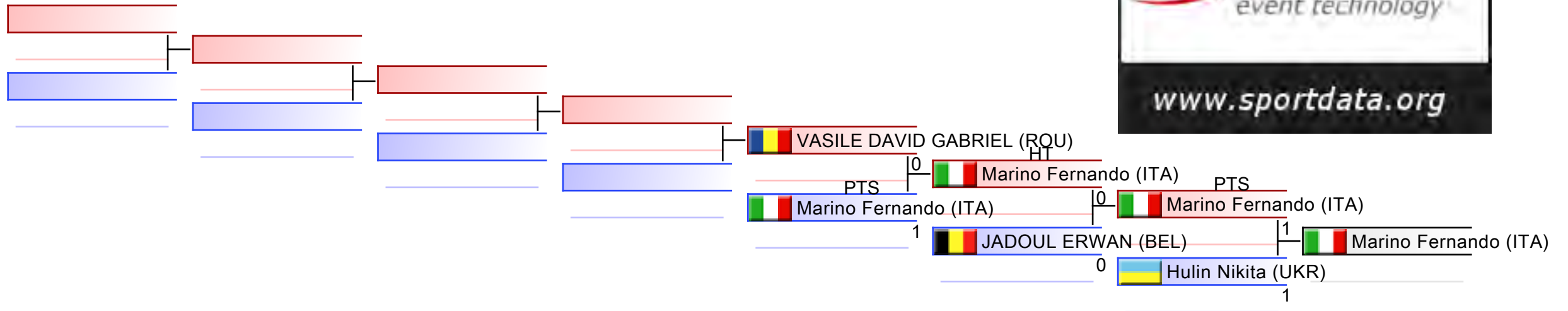

REPECHAGE: (3,4)

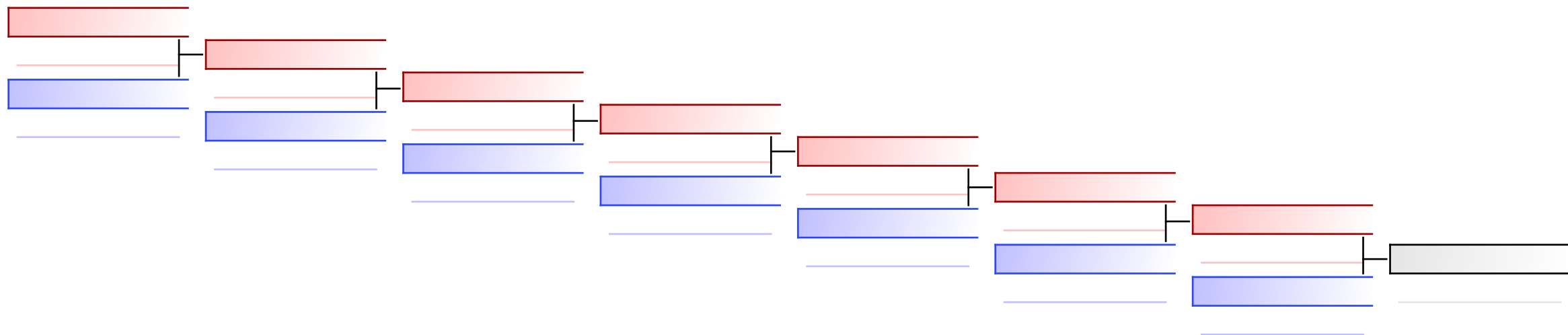



Karate1 Youth League - Venice 2024 - 2024-12-04



Official Results

U21 Kumite Male 84+ kg (Entries: 40 Nations: 24)			
1	STOJANOVIKJ STEFAN		MKD - NORTH MACEDONIA
2	KOZYLIAN OLEKSANDR		UKR - UKRAINE
3	KASIANOV DANIIL		UKR - UKRAINE
3	MARINO FERNANDO		ITA - ITALY
5	DAVIES ALEXANDER		LUX - LUXEMBOURG
5	HULIN NIKITA		UKR - UKRAINE
7	ROSCIGLIONI JONATHAN		ITA - ITALY
7	JADOUL ERWAN		BEL - BELGIUM
9	VAN WOUDEBERG MIKA		NED - NETHERLANDS
9	VASILE DAVID GABRIEL		ROU - ROMANIA



Official Results

Cadet Kata Female (Entries: 117 Nations: 30)			
1	HORI RIA		JPN - JAPAN
2	LEHNER TAMARA		AUT - AUSTRIA
3	BENKÓ SZONJA LOLA		HUN - HUNGARY
3	CASTRO LÓPEZ ROCÍO		ESP - SPAIN
5	DUBLINO BEATRICE		ITA - ITALY
5	NAGLEIN EMMA		ITA - ITALY
7	LIBIK TAMARA		GER - GERMANY
7	ASATO COCORO		JPN - JAPAN
9	BIEDEMANN HANNAH		GER - GERMANY
9	ISKANDARYAN ANNE-MARIE		GER - GERMANY
11	CRUCITTI SOFIA		ITA - ITALY
11	BAGHDJIAN DANA		GER - GERMANY
13	BADJUN ANA		CRO - CROATIA
13	DE PACE MARIA LUISA		ITA - ITALY

Cadet Kata Male (Entries: 118 Nations: 40)			
1	FUKUI KANTA		JPN - JAPAN
2	MATEUS VASCO		POR - PORTUGAL
3	DAVILA MARTIN		USA - UNITED STATES
3	FREDA MATTEO		ITA - ITALY
5	LIBIK DANIEL		GER - GERMANY
5	LEÓN DE LA PEÑA JOSE ANGEL		ESP - SPAIN
7	SPAČIL SAMUEL		SVK - SLOVAKIA
7	ALBIEN ALEXANDER		GER - GERMANY
9	CENCI DIEGO		ITA - ITALY
9	GASPAR RODRIGO		POR - PORTUGAL
11	STEVOVIĆ UROŠ		MNE - MONTENEGRO
11	MC CANN CALVIN		IRL - IRELAND
13	MATKOVIC GRGA		CRO - CROATIA
13	YALKABOV ALLANUR		TKM - TURKMENISTAN

Cadet Kumite Female -47 kg (Entries: 86 Nations: 25)			
1	KOUME LEE-LOU		FRA - FRANCE
2	MATOS ISIS		POR - PORTUGAL
3	BULIC STELA		CRO - CROATIA
3	BESLIJA ELENA		CRO - CROATIA
5	PODVOREC NIVES		GER - GERMANY
5	FERNANDES EMA		POR - PORTUGAL
7	MELLER ADRIANNA		POL - POLAND
7	MAQEDONCI EMIRA		KOS - KOSOVO
9	TERPEZAN MARIA		ROU - ROMANIA
9	GALATI VITTORIA		ITA - ITALY
11	GASPAR MARIA ISABEL		POR - PORTUGAL
11	LEPEZ DARLA		NED - NETHERLANDS



Karate1 Youth League - Venice 2024 - 2024-12-04



Official Results

13	PANASITI GIULIA		ITA - ITALY	
13	NIKOLOVA VIKTORIA		BUL - BULGARIA	

Cadet Kumite Female -54 kg (Entries: 91 Nations: 29)

1	GONCALVES LEONOR		POR - PORTUGAL	
2	SCARFONE MORGANE		FRA - FRANCE	
3	ECHAMAA MARYAM		FRA - FRANCE	
3	SULU KARINA MIHAELA		ROU - ROMANIA	
5	ŠETA ZEJNEB		BIH - BOSNIA AND HERZEGOVINA	
5	BALANESCU IOANA		ROU - ROMANIA	
7	SELLITTI ANNA		ITA - ITALY	
7	MILETA MARE		CRO - CROATIA	
9	KOLLÁROVÁ PATRÍCIA		SVK - SLOVAKIA	
9	BOYADZHIEVA ADRIANA		BUL - BULGARIA	
11	RUPPEL MARIA		GER - GERMANY	
11	GLAVINA ANA-MARIJA		CRO - CROATIA	
13	VALERIO LAURA		ITA - ITALY	

Cadet Kumite Female -61 kg (Entries: 89 Nations: 25)

1	KOENIG LIV SVENDE		GER - GERMANY	
2	MATTYS MELINA		GER - GERMANY	
3	SCHNEIDER ANNA-MARIE		GER - GERMANY	
3	TODERASH OLEKSANDRA		UKR - UKRAINE	
5	GÁSPÁROVÁ JESSICA		SVK - SLOVAKIA	
5	BELKADI JOUMANA		ENG - ENGLAND	
7	SOLTANI DEHNAVI HASTI		IRI - ISLAMIC REPUBLIC OF IRAN	
7	KAPICA ZUZANNA		POL - POLAND	
9	RANČIĆ PAOLA		CRO - CROATIA	
9	ABULIBDE AMIRA		BUL - BULGARIA	
11	NYONI ORIANNA		ENG - ENGLAND	
11	AŠČIĆ ŠEJLA		BIH - BOSNIA AND HERZEGOVINA	
13	MÜHLEMANN NOEMI		SUI - SWITZERLAND	
13	ČORIĆ LEA		CRO - CROATIA	

Cadet Kumite Female 61+ kg (Entries: 88 Nations: 25)

1	DOUKA EFFROSYNI - DAVIDOULA		GRE - GREECE	
2	SCHINDLER MILEY		GER - GERMANY	
3	MURATOVIĆ DZEJNA		BIH - BOSNIA AND HERZEGOVINA	
3	CORREDDU NICOLE		ITA - ITALY	
5	SCHOPP MAKSIMA		GER - GERMANY	
5	KEMETINGER SARAH		AUT - AUSTRIA	
7	MACOVEI DIANA		ROU - ROMANIA	
7	TODOROVIC IVA		SRB - SERBIA	
9	BAYRAM CEYLIN		AUT - AUSTRIA	
9	PASIN MATILDE		ITA - ITALY	
11	LEDIĆ IRMA		CRO - CROATIA	



Official Results

11	THEOBALD MIA		GER - GERMANY	
----	--------------	--	---------------	--

Cadet Kumite Male -52 kg (Entries: 95 Nations: 32)

1	ILCHUK SAVELII		UKR - UKRAINE	
2	VIECHKANOV MAKSYM		UKR - UKRAINE	
3	GANBAROV VUSAL		AZE - AZERBAIJAN	
3	KOVAL DAVID		SVK - SLOVAKIA	
5	GURBANOV REMEZAN		TKM - TURKMENISTAN	
5	AMANDURDYEV GURBANNAZAR		TKM - TURKMENISTAN	
7	ROLAND NATHAN		BEL - BELGIUM	
7	CHAIBI SOUFIAN		ESP - SPAIN	
9	KALIES TOM		GER - GERMANY	
9	HAMOUDANE HAMZA		BEL - BELGIUM	
11	KISELYOV BOGDAN		TKM - TURKMENISTAN	
11	PANTAZIS ATHANASIOS		GRE - GREECE	
13	TREGGIA TOMMASO		ITA - ITALY	

Cadet Kumite Male -57 kg (Entries: 92 Nations: 32)

1	DEBERDT MAHÉ		FRA - FRANCE	
2	KUCHERENKO VASYL		UKR - UKRAINE	
3	KOMARAC FILIP		CRO - CROATIA	
3	MARINO EMANUELE		ITA - ITALY	
5	JANJIC FRANKO		CRO - CROATIA	
5	PIAZZA FRANCESCO		ITA - ITALY	
7	PÉTER CSIKI CSANÁD		HUN - HUNGARY	
7	RUHMANN MAX		GER - GERMANY	
9	SOROCOLITA VASILII		MDA - MOLDOVA, REPUBLIC OF	
9	ZALEVSKIS VITALIJS		LAT - LATVIA	
11	KAKALYYEV ALYMUHAMMET		TKM - TURKMENISTAN	
11	LAZIC LAZAR		BIH - BOSNIA AND HERZEGOVINA	
13	PANARO ALESSANDRO		ITA - ITALY	

Cadet Kumite Male -63 kg (Entries: 90 Nations: 29)

1	DOBROVOLSCHI DENIS		MDA - MOLDOVA, REPUBLIC OF	
2	SOLOMON GLEB		ITA - ITALY	
3	ENEV MARTIN		CZE - CZECH REPUBLIC	
3	BIRAC NIKOLA		CRO - CROATIA	
5	GRZYBEK HUBERT		POL - POLAND	
5	LUCAS MUJICA TOMAS		VEN - VENEZUELA	
7	MRHANI MEHDI		BEL - BELGIUM	
7	POLISTENA ANDREA		ITA - ITALY	
9	CISSOKHO YOUSOUF		FRA - FRANCE	
9	RAHMANOVIĆ IMRAN		BIH - BOSNIA AND HERZEGOVINA	
11	MORILLO LOZANO ISRAEL		ESP - SPAIN	
11	CICHECKI IGOR		POL - POLAND	
13	NAGY AKOS BOTOND		HUN - HUNGARY	



Official Results

13	FALION MAXIM		CZE - CZECH REPUBLIC	
----	--------------	--	----------------------	--

Cadet Kumite Male -70 kg (Entries: 83 Nations: 33)

1	KOZAK KOSTIANTYN		UKR - UKRAINE	
2	RUZ LUIS		VEN - VENEZUELA	
3	SLUKIC PETAR		CRO - CROATIA	
3	GIULIANO SIMONE		ITA - ITALY	
5	PIERANTONI MATTEO		LUX - LUXEMBOURG	
5	ALTIN MUHAMMET EMIR		TUR - TURKIYE	
7	KARAGA ZIJAD		BIH - BOSNIA AND HERZEGOVINA	
7	PIEKHTIERIEV MYKHAILO		UKR - UKRAINE	
9	PAPAGRIGORIOU KOSMAS		GRE - GREECE	
9	FAJT JAKUB		CZE - CZECH REPUBLIC	
11	DEMETRIOU ELEFThERIOS		CYP - CYPRUS	
11	HAMITI ENKEL		KOS - KOSOVO	
13	BOURLARD LENNY		BEL - BELGIUM	

Cadet Kumite Male 70+ kg (Entries: 78 Nations: 30)

1	FERRARINI FRANCESCO		ITA - ITALY	
2	PARKHOMENKO ARTEM		GER - GERMANY	
3	CONTI ALESSANDRO		ITA - ITALY	
3	PRZASNYSKI MICHAL		POL - POLAND	
5	PILLANT MÉTIS		FRA - FRANCE	
5	YAĞLI KAYRA		TUR - TURKIYE	
7	IGARELU VICTOR		ROU - ROMANIA	
7	SOLTIC ERVIN		CRO - CROATIA	
9	KINASH YAROSLAV		UKR - UKRAINE	
9	ESPOSITO NICOLA		ITA - ITALY	
11	AGUIAR ANDRÉ		POR - PORTUGAL	
11	EMÍDIO ABEL		POR - PORTUGAL	

Junior Kata Female (Entries: 116 Nations: 36)

1	SHINJO RINZE		JPN - JAPAN	
2	ORDONEZ INES		FRA - FRANCE	
3	MARQUES RITA		POR - PORTUGAL	
3	RITZ LILA		SUI - SWITZERLAND	
5	OLIVEIRA INÊS		POR - PORTUGAL	
5	MARCONI MARIA		ITA - ITALY	
7	FIALKOVÁ SOFIA		SVK - SLOVAKIA	
7	GRAZIA NICOL		ITA - ITALY	
9	HERRMANN ADELIA		FRA - FRANCE	
9	VILLA MARTINA		ITA - ITALY	
11	TAGLIABUE SILVIA		ITA - ITALY	
11	PUNTA MICAELA		ITA - ITALY	
13	CHOI HAEUN		KOR - REPUBLIC OF KOREA	
13	MIKULIĆ BELLA		CRO - CROATIA	



Official Results

Junior Kata Male (Entries: 107 Nations: 29)			
1	CAPONERA EMANUELE		ITA - ITALY
2	OLIVEIRA MARTIM		POR - PORTUGAL
3	DI RUBBA LUIGI		ITA - ITALY
3	VIEIRA JOÃO		POR - PORTUGAL
5	TSANG PAK YIN		HKG - HONG KONG, CHINA
5	KLEMZ THOMAS		FRA - FRANCE
7	ABU WAHIB JONAS		GER - GERMANY
7	JAKOVLJEVIC VASILIJJE		SRB - SERBIA
9	ROMAGNOLI EMANUEL		ITA - ITALY
9	BARTOLINI FRANCESCO		ITA - ITALY
11	ALJOŠEVIĆ BENJAMIN		MNE - MONTENEGRO
11	ZHOU MARCO		ITA - ITALY
13	PARABOSCHI MATTEO		ITA - ITALY
13	BARBOSA RODRIGO		POR - PORTUGAL

Junior Kumite Female -48 kg (Entries: 63 Nations: 30)			
1	NYMAN AGNES		SWE - SWEDEN
2	HUDYM VERONIKA		UKR - UKRAINE
3	DE FALCO ASIA		ITA - ITALY
3	LEGITTIMO LUDOVICA		ITA - ITALY
5	SANTOS DIANA		POR - PORTUGAL
5	MURGIA ALESSIA		ITA - ITALY
7	VEREBOVÁ SÁRA		SVK - SLOVAKIA
7	MIRANOVIC MASA		SRB - SERBIA
9	BOSSI ALESSANDRA		ITA - ITALY
9	WASILEWSKA ZUZANNA		POL - POLAND
11	DELAROSA KIARA		CAN - CANADA
11	LOYO MONTERO KATHERINE		VEN - VENEZUELA

Junior Kumite Female -53 kg (Entries: 83 Nations: 26)			
1	GASHNIKOVA VERONIKA	AIN	AIN-1 - Individual Neutral Athletes - 1
2	HNES MARIIA		UKR - UKRAINE
3	VASHCHYSHYN ANNA		UKR - UKRAINE
3	NOVAKOVA KATERINA		CZE - CZECH REPUBLIC
5	WONG HAN YI HIDY		HKG - HONG KONG, CHINA
5	KILIÇ NEHIR		TUR - TURKIYE
7	LIUTKEVIČIŪTĖ MIGLĖ		LTU - LITHUANIA
7	MARRUCCI VALENTINA		ITA - ITALY
9	ÇAKIR NİSANUR		TUR - TURKIYE
9	COONEY GRACE		SCO - SCOTLAND
11	HENZE HANNAH		GER - GERMANY
11	MONEGHINI MARTINA		ITA - ITALY
13	TZANI ZOI		GRE - GREECE



Official Results

Junior Kumite Female -59 kg (Entries: 89 Nations: 30)			
1	LIASKALO SOFIIA	AIN	AIN-1 - Individual Neutral Athletes - 1
2	MUDZHUK ALONA		UKR - UKRAINE
3	JUST CLOPES JÚLIA		ESP - SPAIN
3	KLARIC KORINA		CRO - CROATIA
5	ROUSSELOT ELAÏS		FRA - FRANCE
5	ASLAN EZGI		TUR - TURKIYE
7	ECCHILI GRAZIELLA ANNAEL		ITA - ITALY
7	IBRAHIMI QENDRESA		KOS - KOSOVO
9	MUSSWEILER MIA		GER - GERMANY
9	EGEA COLADO MARIA		ESP - SPAIN
11	ALCALA JIMENEZ IRENE		ESP - SPAIN
11	DUTTO GIULIA		ITA - ITALY
13	ROSA COLOMBO SOFIA		ITA - ITALY

Junior Kumite Female -66 kg (Entries: 83 Nations: 30)			
1	PAYROT CHLOE		FRA - FRANCE
2	NOURI SARINA		IRI - ISLAMIC REPUBLIC OF IRAN
3	SAIDANE SARA		FRA - FRANCE
3	ZEUMEROVA ALEXANDRA		SVK - SLOVAKIA
5	FRATILA CRISTINA-MARIA		GER - GERMANY
5	BALUT NATALIA		POL - POLAND
7	HASIC DZENITA		BIH - BOSNIA AND HERZEGOVINA
7	YALIN MESUDE		TUR - TURKIYE
9	DE HAAN FAMA SAMASSA		SEN - SENEGAL
9	CATTANEO ELISA		ITA - ITALY
11	ONANA CHARLÈNE		FRA - FRANCE
11	ANTOINE AURELIE		BEL - BELGIUM
13	SCHWAB LAURA		GER - GERMANY

Junior Kumite Female 66+ kg (Entries: 50 Nations: 24)			
1	ZWANENBURG ROBIN		NED - NETHERLANDS
2	TOMIC SARA		CRO - CROATIA
3	DAWOUD DALIA		GER - GERMANY
3	HAKOVA AMALIE		CZE - CZECH REPUBLIC
5	NASARRE SÁNCHEZ IRENE		ESP - SPAIN
5	FRY AUTUMN		ENG - ENGLAND
7	RIGEADE LAURA MOON		FRA - FRANCE
7	KIROV VANESSA		FIN - FINLAND
9	KASHASH NOUR		SYR - SYRIAN ARAB REPUBLIC
9	COLLADO SANTANO ALBA		ESP - SPAIN
11	TIRABOSCHI LETIZIA		ITA - ITALY
11	DE VIVO ERMELINDA		ITA - ITALY

Junior Kumite Male -55 kg (Entries: 74 Nations: 31)			
1	CELENTANO ANTONIO		ITA - ITALY



Official Results

2	RUDENKO ARSENI		UKR - UKRAINE	
3	FOSCHI SEBASTIAN		ITA - ITALY	
3	GEVORGYAN ALEN		ARM - ARMENIA	
5	DAHMANI AYOUB		FRA - FRANCE	
5	HORNAK FILIP		CZE - CZECH REPUBLIC	
7	AVILOV ARTEM		UKR - UKRAINE	
7	WOJCIECHOWSKI KACPER		POL - POLAND	
9	MONDO BRANCHI MATTEO		ITA - ITALY	
9	OCHOA KEN		USA - UNITED STATES	
11	ABAZI ALDIN		MKD - NORTH MACEDONIA	
11	ĐIDIĆ ISMAIL		BIH - BOSNIA AND HERZEGOVINA	

Junior Kumite Male -61 kg (Entries: 90 Nations: 30)

1	ROMBEAUX MATT		BEL - BELGIUM	
2	TÓTH MÁTÉ ROLAND		HUN - HUNGARY	
3	LUNGU LUCIAN		ROU - ROMANIA	
3	OGUS SAVAS		TUR - TURKIYE	
5	NEAGU-BARZAN ALEXANDRE		ROU - ROMANIA	
5	CALIFANO EMANUELE		ITA - ITALY	
7	MABIC FILIP		CRO - CROATIA	
7	PRANNYCHUK NAZARII		UKR - UKRAINE	
9	VUČKOVIĆ ALEKSANDAR		SRB - SERBIA	
9	IANCU DAVID ADRIAN		ROU - ROMANIA	
11	STANKOV SERHII		UKR - UKRAINE	
11	COIMBRA POL		LUX - LUXEMBOURG	
13	GAVIC KRISTIAN		CRO - CROATIA	

Junior Kumite Male -68 kg (Entries: 92 Nations: 31)

1	TÓTH ZSOMBOR ZOLTÁN		HUN - HUNGARY	
2	PACKWOOD BENJAMIN		SCO - SCOTLAND	
3	TONIOLO ALVISE		ITA - ITALY	
3	ARNAUTOVIC ALI		BIH - BOSNIA AND HERZEGOVINA	
5	OZORUBA NAZARII		UKR - UKRAINE	
5	ODELLO ANDREA		ITA - ITALY	
7	KARLEN THÉO		SUI - SWITZERLAND	
7	HRYNENKO ILLIA		UKR - UKRAINE	
9	TSANEV NIKOLAY		BUL - BULGARIA	
9	BASILE MANUEL		ITA - ITALY	
11	ROZAJAC ADIN		BIH - BOSNIA AND HERZEGOVINA	
11	MUSTAFA HARIS		KOS - KOSOVO	
13	DORIA MATTEO		ITA - ITALY	

Junior Kumite Male -76 kg (Entries: 87 Nations: 28)

1	STRAHIJA SVEN		CRO - CROATIA	
2	PLATISA PASCAL		AUT - AUSTRIA	
3	VERRASTRO RICCARDO		ITA - ITALY	



Official Results

3	WOJARSKI WIKTOR		POL - POLAND	
5	GAYIBOV JAHANGIR		AZE - AZERBAIJAN	
5	MARTIN PEÑA IZAN		ESP - SPAIN	
7	BUDAN PIRVU PATRICK ALEX		ROU - ROMANIA	
7	GLODEANU MARC		ROU - ROMANIA	
9	CARVALHO JAIME		POR - PORTUGAL	
9	TURČANÍK RICHARD		SVK - SLOVAKIA	
11	JABER RAIS WASSIM		BEL - BELGIUM	
11	KORHAN YASIN		GER - GERMANY	
13	CALANDI ROBERTO		ITA - ITALY	

Junior Kumite Male 76+ kg (Entries: 90 Nations: 32)

1	BOHUNICKÝ LUKÁŠ		SVK - SLOVAKIA	
2	MOKAS MICHAIL		GRE - GREECE	
3	SOTIROV BOJIDAR		BUL - BULGARIA	
3	ANISIMOV VLADISLAV		BEL - BELGIUM	
5	BURROSI SAMUELE		ITA - ITALY	
5	KJÆRGAARD SIMON GRØNLUND		DEN - DENMARK	
7	KAMEL BASEM		NED - NETHERLANDS	
7	SETIC TARIK		BIH - BOSNIA AND HERZEGOVINA	
9	TARASENKO ARTEM		UKR - UKRAINE	
9	TENZHALA IVAN		UKR - UKRAINE	
11	OSMANI BLERAND		KOS - KOSOVO	
11	TSCHENISCH THORE		GER - GERMANY	

U14 Kata Female (Entries: 86 Nations: 27)

1	PEÑA GARCIA CANDELA		ESP - SPAIN	
2	SIGISMONDI NOEMI		ITA - ITALY	
3	GRUJANIĆ IRENA		SRB - SERBIA	
3	BAŠAGIĆ EDNA		BIH - BOSNIA AND HERZEGOVINA	
5	BERETTA MARTINA		ITA - ITALY	
5	SASAMOTO MOMONO		JPN - JAPAN	
7	PISNIK MAJA-MARI		SLO - SLOVENIA	
7	TREUN ELENA		AUT - AUSTRIA	
9	BABIĆ MILA		BIH - BOSNIA AND HERZEGOVINA	
9	KNEŽEVIĆ NAĐA		MNE - MONTENEGRO	
11	BOZBEY YÜSRA		TUR - TURKIYE	
11	ISEJNOSKA ADVIJA		GER - GERMANY	
13	LANGHORN ELENA		ENG - ENGLAND	
13	ALEXIA VACAREAN		ROU - ROMANIA	

U14 Kata Male (Entries: 81 Nations: 28)

1	GONZALEZ HUGO		ESP - SPAIN	
2	VERCIMAK MARTIN		SVK - SLOVAKIA	
3	LLEÓ DE SMET JORGE		ESP - SPAIN	
3	GENDES JURAJ		SVK - SLOVAKIA	



Official Results

5	ZADINA EMIL		AUT - AUSTRIA	
5	MATHISON LION LEANDRO ANDRES		ESP - SPAIN	
7	D AURIA LUCA		ITA - ITALY	
7	RAMÍREZ RIVAS ADRIAN		ESP - SPAIN	
9	BONETTI AKIAU LUIGI		USA - UNITED STATES	
9	BILOUS ILLIA		UKR - UKRAINE	
11	HOPKINS FREDDIE		ENG - ENGLAND	
11	D'AUTORIO IGOR		ITA - ITALY	
13	LEWIS CAIAN		WAL - WALES	

U14 Kumite Female -42 kg (Entries: 78 Nations: 29)

1	BAUMGÄRTNER LENA		GER - GERMANY	
2	PRYNDIUK ANASTASIIA		UKR - UKRAINE	
3	SCHUBERT DORA		CRO - CROATIA	
3	EL MESKIRI LENA		LUX - LUXEMBOURG	
5	BIROVÁ EMMA		SVK - SLOVAKIA	
5	VASILOPOULOU EMMANOUELA FOTEINI		GRE - GREECE	
7	ZAKI LAMAR		EGY - EGYPT	
7	ARNAUTOVIĆ ZAHRA		BIH - BOSNIA AND HERZEGOVINA	
9	HORNÁKOVÁ SOFIE		CZE - CZECH REPUBLIC	
9	NEGRONE VIVIANA		ITA - ITALY	
11	CERNEI SOFIA		MDA - MOLDOVA, REPUBLIC OF	
11	KRSTIN ELENA		SRB - SERBIA	

U14 Kumite Female -47 kg (Entries: 82 Nations: 25)

1	BALUT PATRYCJA		POL - POLAND	
2	OLSCHEWSKI HANNA		GER - GERMANY	
3	FILATOVA VERONIKA		UKR - UKRAINE	
3	BELABASS ZINEB		LUX - LUXEMBOURG	
5	OWUSU-AGYEMANG KYLAH		ENG - ENGLAND	
5	IVANCIC KIARA		SLO - SLOVENIA	
7	JERKIN FRANKA		CRO - CROATIA	
7	BYCHENKOVA POLINA		UKR - UKRAINE	
9	YORDANOVA RAYA		BUL - BULGARIA	
9	BOUSCHBACHER LILOU		FRA - FRANCE	
11	ROUSSEAU YSÉE		FRA - FRANCE	
11	TRAMŠEK ALJA		SLO - SLOVENIA	
13	COELHO LEONOR		POR - PORTUGAL	

U14 Kumite Female -52 kg (Entries: 81 Nations: 30)

1	ARCALEAN MIHAELA		USA - UNITED STATES	
2	STEFANSKI VANESSA		FIN - FINLAND	
3	HARUTYUNYAN NANE		ARM - ARMENIA	
3	MEYEN SELDA		GER - GERMANY	
5	SHEVCHENKO KARYNA		UKR - UKRAINE	
5	KRUHLOVA SHARLIZ		UKR - UKRAINE	



Official Results

7	PODLASZEWSKA KIRANA		GER - GERMANY	
7	POPESCU BIANCA		ROU - ROMANIA	
9	MAKSOVIĆ JOVANA		SRB - SERBIA	
9	DE PASQUALE SILVIA		ITA - ITALY	
11	VOIGT JOHANNA		GER - GERMANY	
11	PÖNITZ HAYLEY		GER - GERMANY	
13	SCARSI ALICE		ITA - ITALY	
13	INGALDO ROSALIA		CAN - CANADA	

U14 Kumite Female 52+ kg (Entries: 90 Nations: 26)

1	GAVIOLI MELISSA		ITA - ITALY	
2	CARIDEI CAROLA		ITA - ITALY	
3	GINÉS CHAVARRY PAULA		ESP - SPAIN	
3	PERGALIA AGATHI AGAPI		GRE - GREECE	
5	KLEMPOVÁ LINDA		SVK - SLOVAKIA	
5	BRKOVIC BERINA		BIH - BOSNIA AND HERZEGOVINA	
7	RUDNIKOVA ANASTASIIA		UKR - UKRAINE	
7	SEJDIU REA		KOS - KOSOVO	
9	SVOBODOVA ELISKA		CZE - CZECH REPUBLIC	
9	PEJNOVIĆ ALESSIA		CRO - CROATIA	
11	LFAKIRI IKRAM		FRA - FRANCE	
11	PEZZOTTI ALESSIA		ITA - ITALY	

U14 Kumite Male +55 kg (Entries: 89 Nations: 28)

1	AZADI BIJAN		GER - GERMANY	
2	LYPIVSKYI DANIIL		UKR - UKRAINE	
3	STORNAIUOLO GAETANO		ITA - ITALY	
3	MCGLYNN MICHAEL		IRL - IRELAND	
5	CHAKHTER AMIN		BEL - BELGIUM	
5	CAPIZZI MICHELE		ITA - ITALY	
7	BORJAS SILVA MATHIAS MIGUEL		PER - PERU	
7	TAŞ ILGAZ		TUR - TURKIYE	
9	OSADCHYI SEMEN		UKR - UKRAINE	
9	ZIVKOVIC ILIJA		SRB - SERBIA	
11	PASCALE BRUNO		ITA - ITALY	
11	PAGANO CARMINE		ITA - ITALY	
13	GEORGILAS ZACHARIAS		GRE - GREECE	

U14 Kumite Male -40 kg (Entries: 93 Nations: 31)

1	DALIPI MEVLAN		KOS - KOSOVO	
2	GABRAVA ILIA		GEO - GEORGIA	
3	BERGNA LORENZO		ITA - ITALY	
3	KRASNIQI ANUAR		KOS - KOSOVO	
5	LIESKOVSYI ILLIA		UKR - UKRAINE	
5	SOMASCHINI FILIPPO		ITA - ITALY	
7	FALKOWSKI PATRYK		POL - POLAND	



Official Results

7	MARIMPOLSKYI BOHDAN		LAT - LATVIA	
9	NEKIĆ STJEPAN		CRO - CROATIA	
9	GOR SHAMIRYAN		ARM - ARMENIA	
11	DEGÉE LOUIS		BEL - BELGIUM	
11	BELFILALI OTMANE MOHAMED		FRA - FRANCE	

U14 Kumite Male -45 kg (Entries: 88 Nations: 26)

1	ZALESKI ANTONI		POL - POLAND	
2	SALIMLI ELMADDIN		AZE - AZERBAIJAN	
3	PEREZ MATA DANIEL		ESP - SPAIN	
3	KOUPAL MARTIN		CZE - CZECH REPUBLIC	
5	CALDARESE GENNARO		ITA - ITALY	
5	CAFISO EDOARDO		ITA - ITALY	
7	PERES MAKSZIM		HUN - HUNGARY	
7	FIGA MARTIN		SVK - SLOVAKIA	
9	RAGONE MATTIA		ITA - ITALY	
9	LE CHEVILLER GASPARD		FRA - FRANCE	
11	HOLUB JAN PETER		SVK - SLOVAKIA	
11	ILIJAZI KHAN		KOS - KOSOVO	
13	ALLEGRI MATTEO		ITA - ITALY	

U14 Kumite Male -50 kg (Entries: 86 Nations: 28)

1	TARNAVSKYI MAKSYM		UKR - UKRAINE	
2	PONTIL SCALA LORENZO		ITA - ITALY	
3	SAGRUNOV OLEKSANDR		UKR - UKRAINE	
3	FRATTINA ANDREA DARIO		ITA - ITALY	
5	BARANOWSKI DOMINIK		POL - POLAND	
5	OLMOS DAVID		ESP - SPAIN	
7	MARKOV GEORGI		BUL - BULGARIA	
7	BAGI ÁDÁM		HUN - HUNGARY	
9	TSOY VICTOR		BRA - BRAZIL	
9	MEŇHERT MICHAL		SVK - SLOVAKIA	
11	TETOUR JAN		CZE - CZECH REPUBLIC	
11	KURINOV DANIIL		UKR - UKRAINE	
13	ANGELIS GEORGIOS		GRE - GREECE	

U14 Kumite Male -55 kg (Entries: 80 Nations: 33)

1	GIULIANI ACHILLE		ITA - ITALY	
2	NASSER DIEGO		ITA - ITALY	
3	MRLIAN ADAM JÁN		SVK - SLOVAKIA	
3	ALQATAMI ABDULLAH		KUW - KUWAIT	
5	PAPPALARDO SIMONE		ITA - ITALY	
5	PRYNDIUK ARTEM		UKR - UKRAINE	
7	PANKRATOV ROSTYSLAV		UKR - UKRAINE	
7	BECKMANN MAX		GER - GERMANY	
9	VILLANI MARIO		ITA - ITALY	



Official Results

9	TRIDENTE GIANLUIGI		ITA - ITALY	
11	GLOOR LEON		SUI - SWITZERLAND	
11	BILOKON BOHDAN		UKR - UKRAINE	
13	DEMIRCI KAYRA NEJAN		TUR - TURKIYE	

U21 Kata Female (Entries: 85 Nations: 28)

1	MANCA CHIARA		BEL - BELGIUM	
2	BUI MAI-LINH		FRA - FRANCE	
3	MARTIN ALBA		ESP - SPAIN	
3	MARCHETTI GIULIA		ITA - ITALY	
5	GAMOVA NATASA		SVK - SLOVAKIA	
5	VLAI JESSICA		GER - GERMANY	
7	TEIXEIRA LARA		POR - PORTUGAL	
7	RIBEIRO BARBARA		POR - PORTUGAL	
9	GRUPPIONI ASIA		ITA - ITALY	
9	NIKOLIC MINA		SRB - SERBIA	
11	BUCHSER ANEL		SUI - SWITZERLAND	
11	VALDIVIA MONZON ALEXANDRA SOFIA		PER - PERU	
13	BEREZOVSCAIA ELENA		MDA - MOLDOVA, REPUBLIC OF	

U21 Kata Male (Entries: 88 Nations: 31)

1	SLUGA JURE		SLO - SLOVENIA	
2	POLSINELLI GUIDO		ITA - ITALY	
3	MATACCHIONI LUIGI		ITA - ITALY	
3	BÁRDOS ÁDÁM		HUN - HUNGARY	
5	NOUR MAURIS LORICK		FRA - FRANCE	
5	TRAN WILLIAM		SWE - SWEDEN	
7	MATUSKI GEORGI		BUL - BULGARIA	
7	MOSCATELLI SAMUELE		ITA - ITALY	
9	IWASZKIEWICZ PIOTR		POL - POLAND	
9	FUSCAGNI ALEX		ITA - ITALY	
11	JIGAU MARCO LEONARDO		ITA - ITALY	
11	MILIĆ NIKOLA		MNE - MONTENEGRO	

U21 Kumite Female -50 kg (Entries: 43 Nations: 27)

1	CHAN HSIN-YU		TPE - CHINESE TAIPEI	
2	SGARDELLI EMA		CRO - CROATIA	
3	PYLYPIUK DARIA		UKR - UKRAINE	
3	VIZUETE MIREIA		ESP - SPAIN	
5	COLLETTI EMMA		ITA - ITALY	
5	GODOY MAGDALENA		CHI - CHILE	
7	ORANTES MAGANA SOFIA ALEJANDRA		ESA - EL SALVADOR	
7	HODZIC SARA		BIH - BOSNIA AND HERZEGOVINA	
9	BOUTRACIT AÏCHA		SUI - SWITZERLAND	
9	GENTA MICOL		ITA - ITALY	
11	SLADE MILLIE		ENG - ENGLAND	



Official Results

U21 Kumite Female -55 kg (Entries: 42 Nations: 20)			
1	ORTU REBECCA		ITA - ITALY
2	DRONCHANKA KSENIYA		POL - POLAND
3	KVASNICOVA NINA		SVK - SLOVAKIA
3	ABDESSELEM SILYA		FRA - FRANCE
5	TIEN HSIN-ERH		TPE - CHINESE TAIPEI
5	REZIĆ DORA		CRO - CROATIA
7	WEISS LISA		FRA - FRANCE
7	MALÁ LILIANA		SVK - SLOVAKIA
9	MOLNÁR VIRÁG		HUN - HUNGARY
9	FABBRI GIORGIA		ITA - ITALY

U21 Kumite Female -61 kg (Entries: 55 Nations: 25)			
1	YVON SYDNEY		FRA - FRANCE
2	VACZY ANNA		SVK - SLOVAKIA
3	BOUGRINE AMEL		BEL - BELGIUM
3	SIPOVIC EMINA		BIH - BOSNIA AND HERZEGOVINA
5	MARTURANO IRENE		ITA - ITALY
5	RABHI DOUAA		GER - GERMANY
7	CAMPOBASSO AURORA		ITA - ITALY
7	NAKONECHNA OKSANA		AZE - AZERBAIJAN
9	LOURENÇO DANIELA		POR - PORTUGAL
9	ZURAWSKA ANTONINA		POL - POLAND
11	THOMAS KEARA		SUI - SWITZERLAND
11	CORNOLÓ GIADA		ITA - ITALY

U21 Kumite Female -68 kg (Entries: 48 Nations: 21)			
1	RIEDEL HANNAH		GER - GERMANY
2	TINAVSKA EMA		CZE - CZECH REPUBLIC
3	FOHLINSKA VIRA		UKR - UKRAINE
3	ÁDÁM ALEXANDRA		HUN - HUNGARY
5	SAGYNBEK LAURA		KAZ - KAZAKHSTAN
5	PORQUET FAITH		FRA - FRANCE
7	SIMONINI VALENTINA		ITA - ITALY
7	SAADAQUI SONYA		FIN - FINLAND
9	PORTOGHESE MORENA		ITA - ITALY
9	GIORDANI PAOLA		ITA - ITALY
11	KALAMÁROVÁ ALEXANDRA		SVK - SLOVAKIA
11	VERVOORT TESS		BEL - BELGIUM

U21 Kumite Female 68+ kg (Entries: 37 Nations: 20)			
1	RUSU YULIA		UKR - UKRAINE
2	KROT YULIA		UKR - UKRAINE
3	ZIBRET ZALA MARIA		SLO - SLOVENIA
3	SCHUETZE EMMA		AUT - AUSTRIA
5	SIPOVIC AJLA		BIH - BOSNIA AND HERZEGOVINA



Official Results

5	STECOVA KATERINA		CZE - CZECH REPUBLIC	
7	STASTNA BARBORA		CZE - CZECH REPUBLIC	
7	MCDERMOTT ZOE		IRL - IRELAND	
9	JENIC ANDRIJANA		SUI - SWITZERLAND	
9	PLUTINO FRANCESCA		ITA - ITALY	

U21 Kumite Male -60 kg (Entries: 73 Nations: 27)

1	ABDELMALKI AMIN		BEL - BELGIUM	
2	TORNACI ERHAN		ROU - ROMANIA	
3	OLIVEIRA GUSTAVO		POR - PORTUGAL	
3	DONADIC NINO		CRO - CROATIA	
5	OBITZ FLORIAN		GER - GERMANY	
5	ALAJMI ALI		KUW - KUWAIT	
7	PELAGALLI MATTEO		ITA - ITALY	
7	ALMUTAIRI ABDULLAH		KUW - KUWAIT	
9	FALCO ENZO		FRA - FRANCE	
9	FERJANI YOSRI		CAN - CANADA	
11	JASAREVIC KERIM		BIH - BOSNIA AND HERZEGOVINA	
11	MERKOURIS THEODOROS		GRE - GREECE	
13	SPAMPINATO MARCO GAETANO		ITA - ITALY	
13	PIERBATTISTI RICCARDO		ITA - ITALY	

U21 Kumite Male -67 kg (Entries: 82 Nations: 28)

1	HARUTYUNYAN SUREN		ARM - ARMENIA	
2	RUFINI SAMUELE		ITA - ITALY	
3	GONCALVES GUILHERME		POR - PORTUGAL	
3	GANJZADEH MOHAMMAD-REZA		GER - GERMANY	
5	SMOKVIN OLEKSANDR		UKR - UKRAINE	
5	HIERSO HAIRISS		FRA - FRANCE	
7	TORRES STEVEN		SUI - SWITZERLAND	
7	ALVES RAFAEL		POR - PORTUGAL	
9	BITSORIS ANDREAS		GRE - GREECE	
9	RAMOS MATT STEVEN AUGUSTIN		ITA - ITALY	
11	ASTARITA RAFFAELE		ITA - ITALY	
11	FEO CABO VICTOR		ESP - SPAIN	

U21 Kumite Male -75 kg (Entries: 88 Nations: 32)

1	PITSUL HEORHII		UKR - UKRAINE	
2	TEEFFELEN VAN SEBASTIAAN		NED - NETHERLANDS	
3	OVRAS OLEH		UKR - UKRAINE	
3	WALKER JAMES		ENG - ENGLAND	
5	ZOLOTA ISMAIL		BIH - BOSNIA AND HERZEGOVINA	
5	FRANKEN RICARDO		NED - NETHERLANDS	
7	COOPER-DALLEY JOSEPH		ENG - ENGLAND	
7	PISCOPO LORIS		ITA - ITALY	
9	SHAQIRI ARTIOL		KOS - KOSOVO	



Official Results

9	ZEKHNINI ACHRAF		BEL - BELGIUM	
11	WALGER PHILIPP		GER - GERMANY	
11	MARINO ANGELO		ITA - ITALY	
13	TLILI AHMED RAYANE		GER - GERMANY	

U21 Kumite Male -84 kg (Entries: 50 Nations: 24)

1	PEZZOTTI GABRIELE		ITA - ITALY	
2	SEČKÁR ŠIMON		SVK - SLOVAKIA	
3	JOVOVIĆ LAZAR		MNE - MONTENEGRO	
3	MORAITIS NIKOLAOS		GRE - GREECE	
5	HAAG OZZY		SWE - SWEDEN	
5	AYDEMIR SÜLEYMAN		TUR - TURKIYE	
7	HEINRICH ADRIAN		GER - GERMANY	
7	HERUS OLEH		UKR - UKRAINE	
9	MATSOTAS ATHANASIOS		GRE - GREECE	
9	COSTACHE LUIS ANDREI		ROU - ROMANIA	
11	SNIZEK JIRI		CZE - CZECH REPUBLIC	

U21 Kumite Male 84+ kg (Entries: 40 Nations: 24)

1	STOJANOVIKJ STEFAN		MKD - NORTH MACEDONIA	
2	KOZYLIAN OLEKSANDR		UKR - UKRAINE	
3	KASIANOV DANIIL		UKR - UKRAINE	
3	MARINO FERNANDO		ITA - ITALY	
5	DAVIES ALEXANDER		LUX - LUXEMBOURG	
5	HULIN NIKITA		UKR - UKRAINE	
7	ROSCIGLIONI JONATHAN		ITA - ITALY	
7	JADOUL ERWAN		BEL - BELGIUM	
9	VAN WOUDEBERG MIKA		NED - NETHERLANDS	
9	VASILE DAVID GABRIEL		ROU - ROMANIA	