

RESULTS BOOK

LION CUP 2024 LUXEMBOURG

2024.06.07 - 2024.06.08

297 RUE DE RECKENTHAL L-2410 STRASSEN

LUXEMBOURG, LUX

WWW.SPORTDATA.ORG



TABLE OF CONTENTS

NUMBER OF ENTRIES	3
ENTRYLIST	7
STATISTICS	36
06 - KATA FEMALE U14	38
07 - KATA FEMALE U16	67
08 - KATA FEMALE U18	89
09 - KATA FEMALE U21	115
11 - KATA FEMALE SENIOR	129
17 - KATA MALE U14	160
18 - KATA MALE U16	178
19 - KATA MALE U18	201
20 - KATA MALE U21	223
22 - KATA MALE SENIOR	232
KUMITE FEMALE SENIOR +68KG	372
KUMITE FEMALE SENIOR -50KG	387
KUMITE FEMALE SENIOR -55 KG	398
KUMITE FEMALE SENIOR -61KG	410
KUMITE FEMALE SENIOR -68KG	429
KUMITE FEMALE U12 -30KG	261
KUMITE FEMALE U12 +40KG	439
KUMITE FEMALE U12 -35KG	453
KUMITE FEMALE U12 -40KG	464
KUMITE FEMALE U14 +52KG	283
KUMITE FEMALE U14 -47KG	296
KUMITE FEMALE U14 -52KG	317
KUMITE FEMALE U14 - 42KG	1124
KUMITE FEMALE U16 +61KG	535
KUMITE FEMALE U16 - 61KG	550
KUMITE FEMALE U16 -47KG	480

KUMITE FEMALE U16 -54KG	506
KUMITE FEMALE U18 +66KG	333
KUMITE FEMALE U18 -48KG	573
KUMITE FEMALE U18 -53KG	580
KUMITE FEMALE U18 -59KG	592
KUMITE FEMALE U18 -66KG	338
KUMITE FEMALE U21 + 68KG	610
KUMITE FEMALE U21 - 50KG	620
KUMITE FEMALE U21 - 55KG	631
KUMITE FEMALE U21 - 61KG	641
KUMITE FEMALE U21 - 68KG	652
KUMITE MALE SENIOR +84KG	662
KUMITE MALE SENIOR -60KG	676
KUMITE MALE SENIOR -67KG	690
KUMITE MALE SENIOR -75KG	711
KUMITE MALE SENIOR -84KG	741
KUMITE MALE U12 +45KG	749
KUMITE MALE U12 -35KG	760
KUMITE MALE U12 -45KG	786
KUMITE MALE U14 +50KG	813
KUMITE MALE U14 -40KG	832
KUMITE MALE U14 -45KG	352
KUMITE MALE U14 -50KG	858
KUMITE MALE U16 +70KG	877
KUMITE MALE U16 -52KG	893
KUMITE MALE U16 -57KG	929
KUMITE MALE U16 -63KG	946
KUMITE MALE U16 -70KG	968
KUMITE MALE U18 +76KG	984
KUMITE MALE U18 -55KG	996
KUMITE MALE U18 -61KG	1011
KUMITE MALE U18 -68KG	1031
KUMITE MALE U18 -76KG	1054





























KUMITE MALE U21 - 60KG.....	1101
KUMITE MALE U21 - 67KG.....	1110
KUMITE MALE U21 -75KG.....	1068
KUMITE MALE U21 -84KG/+84KG.....	1090
OFFICIAL RESULTS.....	1144
MEDAL STANDING.....	1160

Lion Cup 2024 Luxembourg

LUXEMBOURG
297 Rue de Reckenthal L-2410 Strassen

2024.06.07 - 2024.06.08

Participation List (by Club/Team)



























#	Code	Club	Male	Female	Total Entries	Total Athletes
1		ALG Association Sportive amateur Ain oussera Algérie(CSNMAO)	1	6	7	7
2		ALG Jeunesse sportive ain el turck[1](J.S.A.E.T[1])	4	2	6	6
3		ALG Moudir(Moudir)	2	0	2	1
4		ALG Samouraï Bethioua(CSA MB)	1	0	1	1
5		AUT LZ Oberösterreich(LZOO)	7	0	7	6
6		AUT Leistungszentrum WIEN(LZ-Wien)	3	2	5	4
7		BEL ABY.Karate Shotokan comines-warneton(ABY.K.S comines-warneton)	3	0	3	2
8		BEL Académie Karate Neupré(AKN)	6	0	6	5
9		BEL Académie Karate bruxelles(Akb)	2	0	2	2
10		BEL Académie Karaté Leponce(AKL)	7	3	10	6
11		BEL Budo Karate Oostende 5001(BKO 5001)	1	0	1	1
12		BEL Bushido Karate Team(BKTeam)	0	4	4	2
13		BEL Champions Club(6110)	9	4	13	9
14		BEL Ecole Martial Fight Pro(EMFP)	2	1	3	3
15		BEL Fudoshin.Team(Fudoshin.Team)	1	0	1	1
16		BEL Furuhashi Matsumoto Dojo[1](F.M.D[1])	0	2	2	1
17		BEL Jundokan Okinawa Goju Ryu Karate Academy Meerhout(Karate Meerhout)	3	0	3	2
18		BEL KARATE CLUB WINNERS(Kcw)	4	0	4	4
19		BEL KC Samoerai Leuven(Samoerai Leuven)	0	1	1	1
20		BEL Karate Club 31(KC31)	4	1	5	4
21		BEL Karate Club BOSNA Liège(Karate Club BOSNA Liège)	0	1	1	1
22		BEL Karate Vlaanderen(KV)	7	4	11	11
23		BEL Karateclub Goju Geel(GJGB)	2	1	3	2
24		BEL Karateclub Kachi Ninove[2](KC Kachi[2])	1	0	1	1
25		BEL Karateclub Shingitai Hoeselt[1](KSH[1])	3	0	3	3
26		BEL Karaté Club Baudour asbl(5101)	4	3	7	6
27		BEL Karaté club Wallonie[5](BELGIUM[5])	6	2	8	8
28		BEL Shinobi Karaté Club(Shinobi)	4	1	5	5
29		BEL Tomodachi st-truiden/zoutleeuw(tomodachi)	0	1	1	1
30		BEL VORIS KARATE SCHOTEN[3](Vorisschoten[3])	1	4	5	4
31		BEL WAKAI TEAM(5123)	3	4	7	7
32		BEL Yamatsuki-Karaté Bruxelles(Y.T.K.B)	4	2	6	6
33		BEL chardon(2087)	4	10	14	13
34		BEL irzi(irzi)	1	0	1	1
35		BEL karate club andenne-seilles[1](kc andenne-seilles[1])	1	1	2	2
36		DEN Budo sportskarate Ishøj(BSI)	0	2	2	2
37		EGY Golden academy[1](Golden[1])	6	2	8	7
38		ENG Emprise Academy[5](EA[5])	4	1	5	4
39		ENG Kaisho Karate(Kaisho Karate)	1	0	1	1
40		ENG Khalsa Karate Association[25](KKA[25])	1	0	1	1
41		ESP Karate Club Funakoshi (Funakoshi)	1	0	1	1

Lion Cup 2024 Luxembourg

LUXEMBOURG
297 Rue de Reckenthal L-2410 Strassen

2024.06.07 - 2024.06.08

Participation List (by Club/Team)

42		FIN	Sportskarate.fi(SPF)	0	3	3	3
43		FRA	A.A.S.S. KARATE SARCELLES(A.S. SARCELLES)	7	3	10	7
44		FRA	Club Omni Sport de Villers-Lès-Nancy[2](COS VILLERS[2])	2	0	2	2
45		FRA	EVRY-COURCOURONNES SAINT-MICHEL 91(EVRY-COURCOURONNES SAINT-MICHEL 91)	1	0	1	1
46		FRA	KARATE CLUB DE CHARENTON - SAINT-MAURICE(KCCSM)	3	6	9	7
47		FRA	KARATE CLUB DE VILLEPINTE ET OMNISPORTS(KCVO)	3	0	3	3
48		FRA	KARATE GOJU-RYU POUILLY(KARATE GOJU-RYU POUILLY)	0	2	2	2
49		FRA	KARATE MJC YUTZ(MJC YUTZ)	0	1	1	1
50		FRA	KARATE-DO LONGWY[14][5](KDL[5])	4	9	13	12
51		FRA	Karate club longuyon(KC longuyon)	2	0	2	2
52		FRA	Karaté club Rehon[KCR54](KCR[54])	1	0	1	1
53		FRA	RKC RUMEGIES[11](RKC[11])	0	1	1	1
54		FRA	Shotokan Karaté Club Verdun[4](SKCV[4])	1	0	1	1
55		FRA	Sporting Karaté Budo Elite(SKB Elite)	6	16	22	16
56		FRA	USI KARATE(SALMI)	2	0	2	2
57		FRA	USJC KARATE(USJC KARATE)	1	0	1	1
58		FRA	USLM Karaté Mont-Saint-Martin(USLM Karaté)	3	6	9	9
59		GER	KV Nordhorn(KV NOH)	0	4	4	4
60		GER	Karate Dojo Dietzenbach[1](KDD[1])	1	1	2	2
61		GER	Karate Dojo Köllerbach e.V.(K.D. Köllerbach)	1	0	1	1
62		GER	Karate-Sport-Center Freudenstadt[1](KSC Freudenstadt[1])	2	0	2	2
63		GER	Shotokan - Karate Saarwellingen e.V.(SK SWG)	2	2	4	4
64		GER	Team FightClub Westerwald(TFC Westerwald)	0	2	2	2
65		IRL	I.K.K.U.[1](IKKU[6][1])	5	0	5	4
66		IRL	WSKF Senshi(Senshi Karate)	1	0	1	1
67		LUX	Chinto Kayl(Chinto Kayl)	6	6	12	11
68		LUX	KC Walfer[1](KC Walfer[1])	8	18	26	21
69		LUX	Kamigaito Wado Ryu Karate Mamer(KWRKM)	3	0	3	2
70		LUX	Karate Club Bettembourg[17](kcb[17])	0	1	1	1
71		LUX	Karate Club Differdange[1](KC Differdange[1])	16	3	19	14
72		LUX	Karate Club Lintgen(KC Lintgen)	1	10	11	9
73		LUX	Karate Club Strassen[3](KC Strassen[3])	24	23	47	41
74		LUX	Karate Club Suessem(KC Suessem)	2	2	4	2
75		LUX	Karate Samurai Dudelange[5](KS Dudelange)	2	1	3	3
76		LUX	Karaté Club Niederanven(KC Niederanven)	7	3	10	9































Lion Cup 2024 Luxembourg

LUXEMBOURG

2024.06.07 - 2024.06.08

297 Rue de Reckenthal L-2410 Strassen

Participation List (by Club/Team)



77		NED	BVL Fighting[3](NETHERLAND[3])	0	1	1	1
78		NED	Budoschool Kai Sei[1](Kai Sei[1])	4	1	5	5
79		NED	Choku-Zaandam[3](Choku 075[3])	4	8	12	8
80		NED	Geoffrey Berens Karate Academy(GBKA)	4	1	5	4
81		NED	Karate Moerdijk[7](KM[7])	1	2	3	2
82		NED	Karate Mossel-Boot(MOSSEL)	2	1	3	3
83		NED	Karate Team Utrecht(KTU)	2	2	4	4
84		NED	Karate team Sonnema[2](KTS[2])	1	0	1	1
85		NED	Karate-Do Buitenveldert [1][3](KB[3])	0	5	5	3
86		NED	KarateKenamju Haarlem[2](KarateKenamju[2])	7	12	19	17
87		NED	Karateschool Alken[2](R. Alken[2])	3	0	3	3
88		NED	Karateschool Bu Shin Kan(BuShinKan)	2	0	2	1
89		NED	Karateschool Fightin Nabil(KSFN, NED)	24	21	45	40
90		NED	Rene Smaal Karate[10](RSK[10])	4	2	6	6
91		NED	Sportschool Muilwijk[1](04-006)	5	0	5	4
92		NED	Sportschool van Laar[1](SVL[1])	0	1	1	1
93		NED	Sportschool van den Nieuwendijk[1](SVDN[1])	1	0	1	1
94		NED	Unity99[1](Unity99[1])	0	1	1	1
95		NED	Unity99[4](Unity99[4])	11	6	17	16
96		NOR	Sportskarate Drammen[4](SKD[1][4])	4	5	9	7
97		POL	Klub Sportowy Morote(Morote)	2	4	6	5
98		POR	CKMaia[1](CKMaia[1])	1	2	3	2
99		POR	Centro Budo de Fafe[3](CBF[3])	3	0	3	3
100		POR	KSVA - PORTUGAL[12](KSVA[12])	2	0	2	2
101		SCO	FJK-Scotland(FJK-Scotland)	2	0	2	1
102		SUI	EKTS Lausanne Vufflens(EKTS Vaud)	2	1	3	2
103		SUI	Elson Sport & Karate(Elson Sport)	5	0	5	4
104		SUI	Goju Kan Bern(Goju Kan Bern)	2	0	2	1
105		SUI	Karate Club Fribourg(KC Fribourg)	4	1	5	4
106		SUI	Karate Club Valais(KC Valais)	3	0	3	3
107		SUI	Karate Do Brugg(KDB)	13	4	17	11
108		SUI	Karate Emme[1](SWITZERLAND[1])	2	5	7	4
109		SUI	Karatecenter Reto Kern Kreuzlingen(KCRK)	2	7	9	8
110		SUI	Karatedo Lyss-Aarberg(KDLyss)	8	14	22	19
111		SUI	Karaté Club Jaguar Vallorbe(KCJ)	2	0	2	2
112		SUI	Kenseikan Karate-Do Thun(Ken Thun)	3	2	5	2
113		SUI	Neuchâtel Karaté-do(NKD)	0	1	1	1
114		SUI	Quirici2020(Qu20)	0	10	10	6
115		SUI	SSKF Karate Team(SSKF Karate Team)	11	7	18	16
116		SUI	Shinsei Kan Lenzburg(ShinseiKan)	8	3	11	9
117		SUI	Swiss Karate Union[1](SKU[1])	27	25	52	41
118		SUI	karateschule sursee(k.s.sursee)	4	8	12	10
119		SWE	Gymnastik och Atletklubben Enighet(GAK Enighet)	0	1	1	1
120		SWE	Lunds karateklubb[4](LKK[4])	1	0	1	1
121		SWE	Shiai IF(Shiai IF)	0	1	1	1
122		SWE	Turebergs Karateklubb[3](TKB[3])	0	1	1	1

Lion Cup 2024 Luxembourg

LUXEMBOURG
297 Rue de Reckenthal L-2410 Strassen

2024.06.07 - 2024.06.08

Participation List (by Club/Team)

123		SWE	UNITED SPORTCENTER[5](USC[5])	1	0	1	1
124		TUN	Ettaleb(Ettaleb)	0	1	1	1
125		WAL	Wales Karate-Do Wadokai- BIKO(WKW - BIKO)	1	2	3	2
Totals:				419	357	776	651

Lion Cup 2024 Luxembourg

LUXEMBOURG
297 Rue de Reckenthal L-2410 Strassen

2024.06.07 - 2024.06.08

ENTRY LIST BY CLUB

ALGERIA

Association Sportive amateur Ain oussera Algérie(CSNMAO)

ID	Sex	Family Name	Given Name	Category
1	Female	BELLATRECHE	NOORHANE INES	Kumite Female U16 -47kg
2	Female	FAREH	RIM	Kumite Female U16 - 61KG
3	Male	MESSAHEL	WAEEL ABDELKADER	Kumite Male U16 -52kg
4	Female	MOUGHARI	IBTIHAL TAKOUA	Kumite female U14 - 42kg
5	Female	MOUGHARI	ROUIA RAOUANE	Kumite Female U18 -53kg
6	Female	SADAoui	MERYEM LOUDJEYN	Kumite Female U16 -47kg
7	Female	YAICHE	CELIA	Kumite Female U16 -47kg

Entries: 7

Jeunesse sportive ain el turck(J.S.A.E.T)

ID	Sex	Family Name	Given Name	Category
8	Female	AMMOUR	IMENE	Kumite Female U16 -54kg
9	Male	BEKHOUKHA	MOHAMED	Kumite Male U16 -52kg
10	Male	MARCHOUD	MOHAMED HICHEM	Kumite Male U16 +70kg
11	Male	SAHRAoui	MOHAMMED AMINE	Kumite Male U18 -68kg
12	Male	TOUIDJINE	ABDELILLAH	Kumite Male U18 -55kg
13	Female	TOUIDJINE	SAMAH ZOULIKHA	KUMITE FEMALE U14 +52KG

Entries: 6

Moudir(Moudir)

ID	Sex	Family Name	Given Name	Category
14	Male	Moudir	Adel	Kumite Male Senior +84kg
15	Male	Moudir	Adel	Kumite Male Senior -84kg

Entries: 2

Samouraï Bethioua(CSA MB)

ID	Sex	Family Name	Given Name	Category
16	Male	SERHANI	ISLEM	Kumite Male Senior -60kg

Entries: 1

AUSTRIA

Leistungszentrum WIEN(LZ-Wien)

ID	Sex	Family Name	Given Name	Category
17	Male	Anderl	Lionel	Kumite Male U12 -45kg
18	Female	Kovacevic	Leoni	Kumite Female U16 - 61KG
19	Male	Lang	Marcus	Kumite Male Senior -60kg
20	Male	Lang	Marcus	Kumite Male U21 - 60kg
21	Female	Lehner	Leonie	Kumite Female U18 -59kg

Entries: 5

Lion Cup 2024 Luxembourg

LUXEMBOURG
297 Rue de Reckenthal L-2410 Strassen

2024.06.07 - 2024.06.08

ENTRY LIST BY CLUB

LZ Oberösterreich(LZOÖ)

ID	Sex	Family Name	Given Name	Category
22	Male	Ackerbauer	Sebastian Andreas	Kumite Male U16 -52kg
23	Male	CHEBAN	Oleksandr	Kumite Male U16 -63kg
24	Male	Fortner	Niklas	Kumite Male U18 -68kg
25	Male	Grigorasenco	Nichita	Kumite Male U21 -75kg
26	Male	Grigorasenco	Nichita	Kumite Male Senior -75kg
27	Male	Mayr	Werner	Kumite Male U18 +76kg
28	Male	WINTERSPERGER	Lorenz	Kumite Male U18 -61kg

Entries: 7

BELGIUM

ABY.Karate Shotokan comines-warneton(ABY.K.S comines-warneton)

ID	Sex	Family Name	Given Name	Category
29	Male	El mesbahi	ali	Kumite Male U21 -84kg/+84kg
30	Male	El mesbahi	ali	Kumite Male Senior -84kg
31	Male	EL MESBAHI	younes	18 - Kata Male U16

Entries: 3

Académie Karate bruxelles(Akb)

ID	Sex	Family Name	Given Name	Category
32	Male	Hamoudane	Hamza	Kumite Male U16 -52kg
33	Male	Zakhnini	Imrane	Kumite Male U14 -40kg

Entries: 2

Académie Karate Neupré(AKN)

ID	Sex	Family Name	Given Name	Category
34	Male	Bouzahzah	Isshak-Mohamed	Kumite Male Senior -67kg
35	Male	Bouzahzah	Isshak-Mohamed	Kumite Male U21 - 67kg
36	Male	Bouzahzah	Wail	Kumite Male U16 -52kg
37	Male	Ferrari	Samuel	KUMITE MALE U14 -45kg
38	Male	Mrhani	Mehdi	Kumite Male U16 -63kg
39	Male	Palm	Lucas	Kumite Male U12 -35kg

Entries: 6

Académie Karaté Leponce(AKL)

ID	Sex	Family Name	Given Name	Category
40	Male	Anisimov	Danyil	Kumite Male U21 -84kg/+84kg
41	Male	Anisimov	Danyil	Kumite Male Senior -84kg
42	Male	Anisimov	vladislav	Kumite Male U18 +76kg
43	Male	Anisimov	vladislav	19 - Kata Male U18
44	Male	Boullard	Lenny	Kumite Male U16 -57kg
45	Male	Dernoncourt	Sofiane	17 - Kata Male U14
46	Male	Dernoncourt	Sofiane	Kumite Male U14 -40kg
47	Female	Guinotte	Shona	Kumite Female Senior -50kg

Lion Cup 2024 Luxembourg

LUXEMBOURG
297 Rue de Reckenthal L-2410 Strassen

2024.06.07 - 2024.06.08

ENTRY LIST BY CLUB

Académie Karaté Leponce(AKL)

ID	Sex	Family Name	Given Name	Category
48	Female	Guinotte	Shona	Kumite Female U21 - 50kg
49	Female	Sridi	Maissa	Kumite Female U16 +61KG

Entries: 10

Budo Karate Oostende 5001(BKO 5001)

ID	Sex	Family Name	Given Name	Category
50	Male	Gjemajl	Ademi	Kumite Male Senior -60kg

Entries: 1

Bushido Karate Team(BKTeam)

ID	Sex	Family Name	Given Name	Category
51	Female	LENARTZ	Maeva	11 - Kata Female Senior
52	Female	LENARTZ	Maeva	08 - Kata Female U18
53	Female	MILER	Gelsey	11 - Kata Female Senior
54	Female	MILER	Gelsey	08 - Kata Female U18

Entries: 4

Champions Club(6110)

ID	Sex	Family Name	Given Name	Category
55	Male	Abdelmaki	Youssef	Kumite Male U16 -52kg
56	Male	Azibous	Yanis	Kumite Male U14 -40kg
57	Male	Blavier	Anthony	Kumite Male Senior -84kg
58	Male	Ejja	Amine	Kumite Male Senior -67kg
59	Male	Ejja	Amine	Kumite Male U21 - 67kg
60	Female	Ejja	Imane	Kumite Female U21 - 55kg
61	Female	Ejja	Imane	Kumite Female Senior -55 kg
62	Male	Panza	Ethan	Kumite Male U21 -75kg
63	Male	Panza	Ethan	Kumite Male Senior -75kg
64	Female	Van de Velde	Elhya	Kumite Female U12 +40kg
65	Female	Yuksektepe	Asya	Kumite Female U18 -53kg
66	Male	Yuksektepe	Hamza	Kumite Male U21 -75kg
67	Male	Yuksektepe	Hamza	Kumite Male Senior -75kg

Entries: 13

chardon(2087)

ID	Sex	Family Name	Given Name	Category
68	Female	Aurélie	Antoine	Kumite Female U18 -59kg
69	Female	BOUHNA	Assiya	KUMITE FEMALE U14 +52KG
70	Female	COMPAGNON	Salsabile	KUMITE FEMALE U12 -30KG
71	Male	DE BRUYNE	STAN	Kumite Male U18 -61kg
72	Female	EL LAHIOUI	Alham	Kumite Female U16 - 61KG
73	Female	EL LAHIOUI	Aya	Kumite Female U16 -54kg
74	Female	LE MESTRE	LARA	Kumite Female Senior -61kg
75	Male	LUSALA	HENOCK	Kumite Male U12 -35kg
76	Female	MAATOUG	Meryame	Kumite Female U12 -35kg

Lion Cup 2024 Luxembourg

LUXEMBOURG
297 Rue de Reckenthal L-2410 Strassen

2024.06.07 - 2024.06.08

ENTRY LIST BY CLUB

chardon(2087)					
ID	Sex	Family Name	Given Name	Category	
77	Female	MAATOUG	Nargesse	Kumite Female U18 -59kg	
78	Female	PATRUNSU	DENISA	Kumite Female U16 -47kg	
79	Female	PATRUNSU	DENISA	Kumite Female U16 -54kg	
80	Male	TSHIBASSU	Christopher	Kumite Male U16 +70kg	
81	Male	ZOUEINI	Rayan	Kumite Male U16 -63kg	

Entries: 14

Ecole Martial Fight Pro(EMFP)					
ID	Sex	Family Name	Given Name	Category	
82	Male	Laruelle	Leo	Kumite Male U16 -52kg	
83	Male	Tamburrini	Doriano	Kumite Male U18 -68kg	
84	Female	Tamburrini	Titia	Kumite Female U16 - 61KG	

Entries: 3

Fudoshin.Team(Fudoshin.Team)					
ID	Sex	Family Name	Given Name	Category	
85	Male	Bauweraerts	Luca	Kumite Male U16 -70kg	

Entries: 1

Furuhata Matsumoto Dojo(F.M.D)					
ID	Sex	Family Name	Given Name	Category	
86	Female	Henroteaux	Lou	11 - Kata Female Senior	
87	Female	Henroteaux	Lou	08 - Kata Female U18	

Entries: 2

irzi(irzi)					
ID	Sex	Family Name	Given Name	Category	
88	Male	messoudi	elias	Kumite Male Senior -84kg	

Entries: 1

Jundokan Okinawa Goju Ryu Karate Academy Meerhout(Karate Meerhout)					
ID	Sex	Family Name	Given Name	Category	
89	Male	Van Den Nieuwenhuijzen	Leroy	Kumite Male Senior -67kg	
90	Male	Van Den Nieuwenhuijzen	Leroy	Kumite Male U21 - 67kg	
91	Male	Van Den Nieuwenhuijzen	Vince	Kumite Male U14 -40kg	

Entries: 3

Karate Club 31(KC31)					
ID	Sex	Family Name	Given Name	Category	
92	Male	Bergiers	Teano	Kumite Male U14 -40kg	
93	Female	Manca	Giulia	08 - Kata Female U18	
94	Male	Roland	Nathan	Kumite Male U16 -52kg	
95	Male	Roland	Tom	Kumite Male U21 -75kg	
96	Male	Roland	Tom	Kumite Male Senior -75kg	

Lion Cup 2024 Luxembourg

LUXEMBOURG
297 Rue de Reckenthal L-2410 Strassen

2024.06.07 - 2024.06.08

ENTRY LIST BY CLUB

Entries: 5

 karate club andenne-seilles(kc andenne-seilles)					
ID	Sex	Family Name	Given Name	Category	
97	Male	Degée	Louis	17 - Kata Male U14	
98	Female	Poskin	Emilie	KUMITE FEMALE U14 -52KG	

Entries: 2

 Karate Club BOSNA Liège(Karate Club BOSNA Liège)					
ID	Sex	Family Name	Given Name	Category	
99	Female	Kurtalic	Sherazad	KUMITE FEMALE U14 -47KG	

Entries: 1

 KARATE CLUB WINNERS(Kcw)					
ID	Sex	Family Name	Given Name	Category	
100	Male	amine azahaf	mohamed	Kumite Male U16 +70kg	
101	Male	es-salehy	ismail	KUMITE MALE U14 -45kg	
102	Male	lazaridis	panagiotis	Kumite Male U16 +70kg	
103	Male	tsetsilas	athanasios	Kumite Male U18 -76kg	

Entries: 4

 Karate Vlaanderen(KV)					
ID	Sex	Family Name	Given Name	Category	
104	Male	Abu Khail	Mohammad	Kumite Male Senior -84kg	
105	Female	Bougrine	Amel	Kumite Female U21 - 61kg	
106	Female	Bougrine	Amina	Kumite Female U21 - 68kg	
107	Male	Dasoul	Michael	Kumite Male Senior -60kg	
108	Male	Dendas	rigo	Kumite Male U16 -63kg	
109	Male	Kavak	Tufan	Kumite Male U18 -61kg	
110	Female	Moons Cruz	Mayla	Kumite Female U16 -47kg	
111	Male	pauwels	lieven	Kumite Male Senior -75kg	
112	Female	Pauwels	Victoria	Kumite Female U21 - 50kg	
113	Male	Vanderheyden	Roel	Kumite Male U16 +70kg	
114	Male	Verhuyght	Kenny	Kumite Male U18 -61kg	

Entries: 11

 Karateclub Goju Geel(GJGB)					
ID	Sex	Family Name	Given Name	Category	
115	Male	Albu	David	Kumite Male U14 -50kg	
116	Male	Albu	David	17 - Kata Male U14	
117	Female	Albu	Diana	KUMITE FEMALE U12 -30KG	

Entries: 3

 Karateclub Kachi Ninove(KC Kachi)					
ID	Sex	Family Name	Given Name	Category	
118	Male	Gilles	Boschmans	18 - Kata Male U16	

Entries: 1

Lion Cup 2024 Luxembourg

LUXEMBOURG
297 Rue de Reckenthal L-2410 Strassen

2024.06.07 - 2024.06.08

ENTRY LIST BY CLUB

 Karateclub Shingitai Hoeselt(KSH)					
ID	Sex	Family Name	Given Name	Category	
119	Male	Bentaya	Nathan	Kumite Male U12 -45kg	
120	Male	Boulogne	Thibaut	Kumite Male U12 -45kg	
121	Male	Snellings	Giel	Kumite Male U16 -52kg	

Entries: 3

 Karaté Club Baudour asbl(5101)					
ID	Sex	Family Name	Given Name	Category	
122	Female	Choly	Fostine	Kumite Female Senior -61kg	
123	Male	Cucciniello	Enzo	Kumite Male U16 -70kg	
124	Male	Leistedt	Oliver	Kumite Male U14 +50kg	
125	Male	Marreda-le-Maignent	Sasha	18 - Kata Male U16	
126	Male	Sautelet	Arthur	Kumite Male U16 -70kg	
127	Female	Scuflaire	Emma	09 - Kata Female U21	
128	Female	Scuflaire	Emma	11 - Kata Female Senior	

Entries: 7

 Karaté club Wallonie(BELGIUM)					
ID	Sex	Family Name	Given Name	Category	
129	Male	BOSCOLO	NATHAN	Kumite Male U14 -40kg	
130	Female	DAUBY	ANAELLE	Kumite Female U18 -53kg	
131	Male	Disalvo	Samuel	Kumite Male U14 +50kg	
132	Male	KONRADOWSKI	ANDREAS	Kumite Male U16 -57kg	
133	Male	QUARANTA	CALOGERO	Kumite Male U16 -57kg	
134	Male	QUARANTA	SAVERIO	Kumite Male U12 -35kg	
135	Female	Rejraji	Yasmine	Kumite Female U16 - 61KG	
136	Male	ROMBEAUX	MATT	Kumite Male U18 -61kg	

Entries: 8

 KC Samoerai Leuven(Samoerai Leuven)					
ID	Sex	Family Name	Given Name	Category	
137	Female	Vanrooy	Chiara	Kumite Female U16 +61KG	

Entries: 1

 Shinobi Karaté Club(Shinobi)					
ID	Sex	Family Name	Given Name	Category	
138	Male	El-aidi	Omar	Kumite Male U14 -50kg	
139	Male	El-Aidi	Yahya	Kumite Male U16 -70kg	
140	Male	Guétari	Mohamed	Kumite Male U16 -52kg	
141	Male	Guétari	Oussama	Kumite Male U14 -40kg	
142	Female	Guétari	Yakin	KUMITE FEMALE U14 -47KG	

Entries: 5

 Tomodachi st-truiden/zoutleeuw(tomodachi)					
ID	Sex	Family Name	Given Name	Category	

Lion Cup 2024 Luxembourg

LUXEMBOURG
297 Rue de Reckenthal L-2410 Strassen

2024.06.07 - 2024.06.08

ENTRY LIST BY CLUB

 Tomodachi st-truiden/zoutleew(tomodachi)					
ID	Sex	Family Name	Given Name	Category	
143	Female	angela	raskin	Kumite Female U16 -47kg	

Entries: 1

 VORIS KARATE SCHOTEN(Voris Schoten)					
ID	Sex	Family Name	Given Name	Category	
144	Female	De Wilde	Noa	KUMITE FEMALE U12 -30KG	
145	Male	De Wilde	Senne	Kumite Male U16 -70kg	
146	Female	Vekemans	Luana	Kumite Female U12 +40kg	
147	Female	Vervoort	Tess	Kumite Female U21 - 68kg	
148	Female	Vervoort	Tess	Kumite Female Senior -68kg	



Entries: 5

 WAKAI TEAM(5123)					
ID	Sex	Family Name	Given Name	Category	
149	Male	Bachiri	Mehdi	Kumite Male U12 -35kg	
150	Female	EL HOUDIFI	Anissa	Kumite Female U18 -53kg	
151	Female	EL HOUDIFI	Esma	Kumite Female U12 -40kg	
152	Male	Fadili	Telio	Kumite Male U12 -45kg	
153	Female	SMIDTS	Giulia	Kumite Female U16 -47kg	
154	Female	TARCHI	Sabrina	Kumite Female U16 -54kg	
155	Male	TARCHI	Sedki	Kumite Male U14 -40kg	

Entries: 7

 Yamatsuki-Karaté Bruxelles(Y.T.K.B)					
ID	Sex	Family Name	Given Name	Category	
156	Male	Chakhter	Amin	Kumite Male U14 +50kg	
157	Female	Mansour	Dounya	Kumite Female U18 -59kg	
158	Female	Mansour	Sonia	Kumite Female U12 +40kg	
159	Male	Mehadhebi	Amir	Kumite Male U14 +50kg	
160	Male	Mehadhebi	Rami	Kumite Male U12 -45kg	
161	Male	STIRBU	David	KUMITE MALE U14 -45kg	

Entries: 6

 DENMARK					
 Budo sportskarate Ishøj(BSI)					
ID	Sex	Family Name	Given Name	Category	
162	Female	Aakerman	Sarah Lundquist	Kumite Female Senior -68kg	
163	Female	Aakerman	Sofia Lundquist	Kumite Female U18 -53kg	

Entries: 2

 EGYPT					
--	--	--	--	--	--

Lion Cup 2024 Luxembourg

LUXEMBOURG
297 Rue de Reckenthal L-2410 Strassen

2024.06.07 - 2024.06.08

ENTRY LIST BY CLUB

🇱🇺 Golden academy(Golden)					
ID	Sex	Family Name	Given Name	Category	
164	Male	Aly	Ossama	Kumite Male Senior -84kg	
165	Male	Darwesh	Salah	Kumite Male Senior -75kg	
166	662306	Elrashidy	Ahmed	Kumite Male U12 +45kg	
167	Female	Gaballa	Rama	Kumite female U14 - 42kg	
168	Female	Gaballa	Rama	06 - Kata Female U14	
169	Male	Hegazy	Ammar	19 - Kata Male U18	
170	Male	Mohamed	Salah	19 - Kata Male U18	
171	Male	Rashed	Mohamed	22 - Kata Male Senior	

Entries: 8

🇬🇧 ENGLAND					
🇬🇧 Emprise Academy(EA)					
ID	Sex	Family Name	Given Name	Category	
172	Male	Bridges	Harry	Kumite Male U14 -40kg	
173	Male	Julian	Oscar	Kumite Male U14 -40kg	
174	Male	Monk	Luke	Kumite Male Senior -67kg	
175	Male	Monk	Luke	Kumite Male U21 - 67kg	
176	Female	Monk	Rosie	Kumite Female Senior -55 kg	

Entries: 5

🇯🇵 Kaisho Karate(Kaisho Karate)					
ID	Sex	Family Name	Given Name	Category	
177	Male	Black	Joseph	Kumite Male U18 -55kg	

Entries: 1

🇮🇳 Khalsa Karate Association(KKA)					
ID	Sex	Family Name	Given Name	Category	
178	Male	Howard	London-James	Kumite Male U12 -35kg	

Entries: 1

🇫🇮 FINLAND					
🇫🇮 Sportskarate.fi(SPF)					
ID	Sex	Family Name	Given Name	Category	
179	Female	Kirov	Vanessa	KUMITE FEMALE U18 -66KG	
180	Female	Saadaoui	Sonya	KUMITE FEMALE U18 -66KG	
181	Female	Voutilainen	Sonja	Kumite Female Senior +68kg	

Entries: 3

🇫🇷 FRANCE					
-----------	--	--	--	--	--

Lion Cup 2024 Luxembourg

LUXEMBOURG
297 Rue de Reckenthal L-2410 Strassen

2024.06.07 - 2024.06.08

ENTRY LIST BY CLUB

A.A.S.S. KARATE SARCELLES(A.S. SARCELLES)					
ID	Sex	Family Name	Given Name	Category	
182	Female	BAUDARD	LAURE	11 - Kata Female Senior	
183	Female	BAUDARD	LAURE	08 - Kata Female U18	
184	Male	D ONGHIA	ENZO	22 - Kata Male Senior	
185	Male	D ONGHIA	ENZO	19 - Kata Male U18	
186	Male	Donghia	ALESSIO	17 - Kata Male U14	
187	Male	DUCHAIINE	GREGOIRE	22 - Kata Male Senior	
188	Male	PICAZO LUQUE	Angel	Kumite Male Senior -60kg	
189	Male	PICAZO LUQUE	Angel	Kumite Male U21 - 60kg	
190	Female	PICAZO LUQUE	ELEONORE	Kumite Female U18 -59kg	
191	Male	STASSIAUX	MAHEL	22 - Kata Male Senior	

Entries: 10

Club Omni Sport de Villers-Lès-Nancy(COS VILLERS)					
ID	Sex	Family Name	Given Name	Category	
192	Male	BUISSON	Mattéo	22 - Kata Male Senior	
193	Male	HART	Enoha	17 - Kata Male U14	

Entries: 2

EVRY-COURCOURONNES SAINT-MICHEL 91(EVRY-COURCOURONNES SAINT-MICHEL 91)					
ID	Sex	Family Name	Given Name	Category	
194	Male	Noel	Arthur	22 - Kata Male Senior	

Entries: 1

KARATE CLUB DE CHARENTON - SAINT-MAURICE(KCCSM)					
ID	Sex	Family Name	Given Name	Category	
195	Female	Bas	Loussine	Kumite Female U21 - 50kg	
196	Female	Bas	Loussine	Kumite Female Senior -50kg	
197	Female	Bouhraoua	Loubna	Kumite Female U12 -40kg	
198	Female	Homri	Tesnime	Kumite Female U16 +61KG	
199	Male	Louis	Antonin	22 - Kata Male Senior	
200	Male	Louis	Antonin	19 - Kata Male U18	
201	Female	Mekhane	Hania	Kumite Female U16 - 61KG	
202	Male	Nana	Fakhir	Kumite Male U12 -35kg	
203	Female	Sfihi	Inès	07 - Kata Female U16	

Entries: 9

KARATE CLUB DE VILLEPINTE ET OMNISPORTS(KCVO)					
ID	Sex	Family Name	Given Name	Category	
204	Male	Kunasuthan	Santhosh	18 - Kata Male U16	
205	Male	NGUYEN	ERVIN	17 - Kata Male U14	
206	Male	Nguyen	Thylane	18 - Kata Male U16	

Entries: 3

Lion Cup 2024 Luxembourg

LUXEMBOURG
297 Rue de Reckenthal L-2410 Strassen

2024.06.07 - 2024.06.08

ENTRY LIST BY CLUB

Karate club longuyon(KC longuyon)					
ID	Sex	Family Name	Given Name	Category	
207	Male	DUPUIS	Léo	17 - Kata Male U14	
208	Male	PAULET	Lucas	Kumite Male U16 -63kg	

Entries: 2

KARATE GOJU-RYU POUILLY(KARATE GOJU-RYU POUILLY)					
ID	Sex	Family Name	Given Name	Category	
209	Female	Ancel	Chloe	09 - Kata Female U21	
210	Female	Perie Marx	Manon	07 - Kata Female U16	

Entries: 2

KARATE MJC YUTZ(MJC YUTZ)					
ID	Sex	Family Name	Given Name	Category	
211	Female	NAKANO	LEA	07 - Kata Female U16	

Entries: 1

KARATE-DO LONGWY(KDL)					
ID	Sex	Family Name	Given Name	Category	
212	Female	Al Mouhajir	Wiam	Kumite Female U12 +40kg	
213	Male	ALMEIDA DA SILVA	Alexandre	22 - Kata Male Senior	
214	Male	ASSEMAT	REMI	Kumite Male Senior -75kg	
215	Male	ASSEMAT	REMI	22 - Kata Male Senior	
216	Female	BOURAHILA	Massyla	KUMITE FEMALE U12 -30KG	
217	Female	Geyikpinar	Melissa	KUMITE FEMALE U14 +52KG	
218	Female	Mazzoleni	Naelys	Kumite Female U12 +40kg	
219	Female	RIO	Iliana	06 - Kata Female U14	
220	Male	Tchaldaev	Abdoul	Kumite Male U12 -45kg	
221	Female	Tchaldaev	Gayna	KUMITE FEMALE U14 -52KG	
222	Female	Tchaldaev	Halimat	KUMITE FEMALE U12 -30KG	
223	Female	Yapoby	Camerone	06 - Kata Female U14	
224	Female	Zanoun	Keyla	Kumite Female U12 -40kg	

Entries: 13

Karaté club Rehon(KCR)					
ID	Sex	Family Name	Given Name	Category	
225	Male	ZEDEK	Mokrane	Kumite Male U12 -35kg	

Entries: 1

RKC RUMEGIES(RKC)					
ID	Sex	Family Name	Given Name	Category	
226	Female	Defrance	Inès	06 - Kata Female U14	

Entries: 1

Shotokan Karaté Club Verdun(SKCV)					
ID	Sex	Family Name	Given Name	Category	

Lion Cup 2024 Luxembourg

LUXEMBOURG
297 Rue de Reckenthal L-2410 Strassen

2024.06.07 - 2024.06.08

ENTRY LIST BY CLUB

Shotokan Karaté Club Verdun(SKCV)					
ID	Sex	Family Name	Given Name	Category	
227	Male	Francais	Killian	18 - Kata Male U16	

Entries: 1

Sporting Karaté Budo Elite(SKB Elite)					
ID	Sex	Family Name	Given Name	Category	
228	Female	BERGER	Alicia	Kumite Female U16 -47kg	
229	Female	CEDOLIN	Clara	06 - Kata Female U14	
230	Male	CHOUVIN	Paul	Kumite Male U21 - 67kg	
231	Male	DEMNERLE	Baptiste	19 - Kata Male U18	
232	FR03275	DRUJON	Lucille	09 - Kata Female U21	
233	FR03275	DRUJON	Lucille	11 - Kata Female Senior	
234	FR03435	DRUJON	Maelle	08 - Kata Female U18	
235	FR03435	DRUJON	Maelle	11 - Kata Female Senior	
236	Male	GREGOIRE	Liam	20 - Kata Male U21	
237	Male	GREGOIRE	Liam	22 - Kata Male Senior	
238	Male	GREGOIRE	Loucyane	18 - Kata Male U16	
239	Female	GUILLAUME	Cassandre	11 - Kata Female Senior	
240	Female	GUILLAUME	Cassandre	08 - Kata Female U18	
241	Female	JUSTINE	Kirsten	07 - Kata Female U16	
242	Female	KOUME	Lee-Lou	Kumite Female U16 -47kg	
243	FRA2575	LEITAO	Romane	09 - Kata Female U21	
244	FRA2575	LEITAO	Romane	11 - Kata Female Senior	
245	Male	REBOURS	Ilyes	Kumite Male U16 -52kg	
246	Female	SEKETELI	Eloise	Kumite Female U16 - 61KG	
247	SD67353	VORATOVIC	Iliana	08 - Kata Female U18	
248	SD67353	VORATOVIC	Iliana	07 - Kata Female U16	
249	Female	YORO	Eden	Kumite Female U16 - 61KG	

Entries: 22

USI KARATE(SALMI)					
ID	Sex	Family Name	Given Name	Category	
250	Male	SALMI	Adam Youva	Kumite Male U12 -35kg	
251	Male	SALMI	Anis Tahar	Kumite Male U14 -40kg	

Entries: 2

USJC KARATE(USJC KARATE)					
ID	Sex	Family Name	Given Name	Category	
252	Male	achard	baptiste	Kumite Male Senior -67kg	

Entries: 1

USLM Karaté Mont-Saint-Martin(USLM Karaté)					
ID	Sex	Family Name	Given Name	Category	
253	Female	bougrine	amel	Kumite Female Senior -61kg	
254	Female	bougrine	amina	Kumite Female Senior -68kg	
255	Female	bougrine	nesrine	Kumite Female Senior -68kg	

Lion Cup 2024 Luxembourg

LUXEMBOURG
297 Rue de Reckenthal L-2410 Strassen

2024.06.07 - 2024.06.08

ENTRY LIST BY CLUB

USLM Karaté Mont-Saint-Martin(USLM Karaté)

ID	Sex	Family Name	Given Name	Category
256	Female	Shabayek	Malak	Kumite Female U16 - 61KG
257	Male	Shabayek	Moaz	Kumite Male U16 -52kg
258	Female	Smaili	Anfel	KUMITE FEMALE U14 +52KG
259	Male	Souidi	elias	Kumite Male U14 -50kg
260	Female	stagni	maelie	KUMITE FEMALE U14 -47KG
261	Male	stagni	reia	Kumite Male U18 -68kg

Entries: 9

GERMANY

Karate Dojo Dietzenbach(KDD)

ID	Sex	Family Name	Given Name	Category
262	Male	Bier	Marvin	Kumite Male Senior -75kg
263	Female	Mielke	Nele	Kumite Female Senior -68kg

Entries: 2

Karate Dojo Köllerbach e.V.(K.D. Köllerbach)

ID	Sex	Family Name	Given Name	Category
264	Male	Becker	Jonas	Kumite Male U14 -40kg

Entries: 1

Karate-Sport-Center Freudenstadt(KSC Freudenstadt)

ID	Sex	Family Name	Given Name	Category
265	Male	Morina	Artion	Kumite Male U14 -50kg
266	Male	Morina	Florent	Kumite Male Senior -67kg

Entries: 2

KV Nordhorn(KV NOH)

ID	Sex	Family Name	Given Name	Category
267	Female	Altenhof	Mira	Kumite female U14 - 42kg
268	Female	Mohammad	Rouhaiv	KUMITE FEMALE U14 -52KG
269	Female	Satter	Anna	KUMITE FEMALE U12 -30KG
270	Female	Satter	Sara	KUMITE FEMALE U12 -30KG

Entries: 4

Shotokan - Karate Saarwellingen e.V.(SK SWG)

ID	Sex	Family Name	Given Name	Category
271	Female	Becker	Celine	KUMITE FEMALE U14 -52KG
272	Male	Becker	Tom	Kumite Male U12 -45kg
273	Female	Paulus	Chayenne	KUMITE FEMALE U14 +52KG
274	Male	Ruhmann	Benjamin	Kumite Male U14 -50kg

Entries: 4

Lion Cup 2024 Luxembourg

LUXEMBOURG
297 Rue de Reckenthal L-2410 Strassen

2024.06.07 - 2024.06.08

ENTRY LIST BY CLUB

Team FightClub Westerwald(TFC Westerwald)					
ID	Sex	Family Name	Given Name	Category	
275	Female	Baumgärtner	Lara	Kumite female U14 - 42kg	
276	Female	Baumgärtner	Lena	Kumite Female U12 -40kg	

Entries: 2

IRELAND					
I.K.K.U.(IKKU)					
ID	Sex	Family Name	Given Name	Category	
277	Male	Heneghan	Alex	Kumite Male U16 -70kg	
278	Male	Kelly	Anthony	Kumite Male U21 -75kg	
279	Male	Kelly	Anthony	Kumite Male Senior -75kg	
280	Male	Kelly	Cathal	Kumite Male U18 -61kg	
281	Male	Kelly	Tomas	Kumite Male U18 -55kg	

Entries: 5

WSKF Senshi(Senshi Karate)					
ID	Sex	Family Name	Given Name	Category	
282	Male	O'Sullivan	Conor	Kumite Male Senior -67kg	

Entries: 1

LUXEMBOURG					
Chinto Kayl(Chinto Kayl)					
ID	Sex	Family Name	Given Name	Category	
283	Female	De Rubeis	Giulia	Kumite Female U16 - 61KG	
284	Male	De Rubeis	Leonardo	Kumite Male U12 -45kg	
285	Female	Fonseca	Lara	Kumite Female U12 -35kg	
286	Female	Kieffer	Lynn	Kumite Female U16 -47kg	
287	Male	Kieffer	Tom	Kumite Male U14 -40kg	
288	Female	Kuborn	Lily	Kumite female U14 - 42kg	
289	Female	Pierre	Abby	Kumite Female U16 - 61KG	
290	Male	Spagnuolo	Liam	Kumite Male U14 -50kg	
291	Female	Terlica Gomes	Océane	Kumite Female U16 -54kg	
292	Male	Terlica Gomes	Sebastien	Kumite Male U21 -75kg	
293	Male	Terlica Gomes	Sebastien	Kumite Male Senior -75kg	
294	Male	Van Wissen	Jan	Kumite Male U16 -52kg	

Entries: 12

Kamigaito Wado Ryu Karate Mamer(KWRKM)					
ID	Sex	Family Name	Given Name	Category	
295	Male	Bruscella	Samuele	22 - Kata Male Senior	
296	Male	Bruscella	Samuele	19 - Kata Male U18	
297	Male	Soares	Gonçalo	18 - Kata Male U16	

Entries: 3

Lion Cup 2024 Luxembourg

LUXEMBOURG
297 Rue de Reckenthal L-2410 Strassen

2024.06.07 - 2024.06.08

ENTRY LIST BY CLUB

Karate Club Bettembourg(kcb)					
ID	Sex	Family Name	Given Name	Category	
298	Female	AALALA	Samia	Kumite Female U18 -59kg	

Entries: 1

Karate Club Differdange(KC Differdange)					
ID	Sex	Family Name	Given Name	Category	
299	Male	AGOSTINO	Enzo	Kumite Male U16 -57kg	
300	Male	Almalh	Mahmoud	Kumite Male U21 -75kg	
301	Male	Almalh	Mahmoud	Kumite Male Senior -75kg	
302	Male	Almalh	Mahmoud	Kumite Male Senior -67kg	
303	Male	Almalh	Mahmoud	Kumite Male U21 -67kg	
304	Male	Anatole	Michel	Kumite Male U12 -35kg	
305	Female	Bezruk	Olha	Kumite Female U21 -50kg	
306	Female	Bezruk	Olha	Kumite Female Senior -50kg	
307	Male	DEFENSE	Dario	Kumite Male U14 +50kg	
308	Male	Dong	Andy	18 - Kata Male U16	
309	Male	Fecchi	Matteo	Kumite Male U16 -63kg	
310	Male	Ferreira Perdigao	Rodrigo	Kumite Male U12 +45kg	
311	Male	Jesus Pereira	Matias	17 - Kata Male U14	
312	Female	Kessel	Alexia	KUMITE FEMALE U14 -47KG	
313	Male	Pan	Jaxon	17 - Kata Male U14	
314	Male	Parasiliti Rantone	Mattia	Kumite Male U18 -55kg	
315	Male	Sibille	Jordan	Kumite Male U21 -75kg	
316	Male	Sibille	Jordan	Kumite Male Senior -75kg	
317	Male	Tamim	Yanis	Kumite Male Senior -67kg	

Entries: 19

Karate Club Lintgen(KC Lintgen)					
ID	Sex	Family Name	Given Name	Category	
318	Female	Breisch	Anna	07 - Kata Female U16	
319	Female	Breser	Anastasia	07 - Kata Female U16	
320	Female	Costa	Nuria	06 - Kata Female U14	
321	Female	Gomes	Solara	06 - Kata Female U14	
322	Female	Johanns	Camille	07 - Kata Female U16	
323	Female	Nobre Ameixa	Cynthia	Kumite Female Senior -55 kg	
324	Male	Petry	Kevin	22 - Kata Male Senior	
325	Female	Reding	Mia	11 - Kata Female Senior	
326	Female	Reding	Mia	08 - Kata Female U18	
327	Female	Rodrigo	Sarah	11 - Kata Female Senior	
328	Female	Rodrigo	Sarah	08 - Kata Female U18	

Entries: 11

Karate Club Strassen(KC Strassen)					
ID	Sex	Family Name	Given Name	Category	
329	Female	Belabass	Kenza	Kumite Female Senior -50kg	
330	Female	Belabass	Zineb	KUMITE FEMALE U14 -47KG	

Lion Cup 2024 Luxembourg

LUXEMBOURG
297 Rue de Reckenthal L-2410 Strassen

2024.06.07 - 2024.06.08

ENTRY LIST BY CLUB

Karate Club Strassen(KC Strassen)					
ID	Sex	Family Name	Given Name	Category	
331	Male	Brugnoni	Sacha	Kumite Male U12 -35kg	
332	Male	Chaffort	Lucas	22 - Kata Male Senior	
333	Male	Chaffort	Lucas	20 - Kata Male U21	
334	Male	Cohen sabban	Timothee	KUMITE MALE U14 -45kg	
335	Male	Coimbra	Pol	Kumite Male U18 -55kg	
336	Male	Coimbra	Pol	Kumite Male U21 - 60kg	
337	Female	Couturier	Louise	Kumite Female U16 +61KG	
338	Female	CUSTODERO	Sara	Kumite Female U12 -40kg	
339	Female	Da Nazare	Lena	Kumite Female Senior -55 kg	
340	Male	Georges	Jim	Kumite Male U12 -35kg	
341	Male	Knarov	Ambroise	Kumite Male U14 +50kg	
342	Male	Knarov	Maxence	Kumite Male U18 -68kg	
343	Male	Lambot	Gaspard	Kumite Male U18 -61kg	
344	Female	LEGALL	Romane	Kumite Female U16 -54kg	
345	Male	MAGDA	Marko	Kumite Male U12 -35kg	
346	LUX02317	Female	Martins Dias	Kumite Female U18 -53kg	
347	Female	Moens	Adele	Kumite Female U12 -35kg	
348	Female	Moens	Adele	KUMITE FEMALE U12 -30KG	
349	Female	Moens	Alix	Kumite Female U18 -48kg	
350	Female	Moens	Alix	Kumite Female U21 - 50kg	
351	Female	Muller	Eva	Kumite Female U16 -54kg	
352	Female	Nakano	Mathilde	Kumite female U14 - 42kg	
353	Male	Nedioglo	Dimitrii	Kumite Male U16 -70kg	
354	Male	Pang	Jason	KUMITE MALE U14 -45kg	
355	Male	PARASCHIV	Mihai	Kumite Male U12 -45kg	
356	Female	Plingers	Aleonor	KUMITE FEMALE U14 +52KG	
357	Male	Pupkus	Lukas	Kumite Male U12 +45kg	
358	Male	Rimilinger	Jean	Kumite Male U14 -50kg	
359	Male	ROMAN	Andrea	Kumite Male U12 -45kg	
360	Female	Rosa	Maelys	KUMITE FEMALE U14 -52KG	
361	Female	Rusovici	Catalina	Kumite Female U12 -40kg	
362	Male	SZEKERES	Maxim	Kumite Male U16 -52kg	
363	Female	Taibi	Nuria	Kumite Female U12 -40kg	
364	Male	Teixeira	Tomas	Kumite Male U21 - 60kg	
365	Male	Teixeira	Tomas	Kumite Male Senior -60kg	
366	Female	Theisen	Margot	07 - Kata Female U16	
367	Female	Theisen	Margot	Kumite Female U16 -54kg	
368	Female	Theisen	Monique	KUMITE FEMALE U18 -66KG	
369	Female	Theisen	Monique	08 - Kata Female U18	
370	Female	TIZOURINE	Lisa	Kumite Female U21 - 61kg	
371	Female	TIZOURINE	Lisa	Kumite Female Senior -61kg	
372	Male	TIZOURINE	Massi	Kumite Male U16 -63kg	
373	Male	Todorovic	Filip	Kumite Male U16 -63kg	
374	Male	Vilm	J�rome	22 - Kata Male Senior	
375	Male	Yildirm	Ali	KUMITE MALE U14 -45kg	

Entries: 47

Lion Cup 2024 Luxembourg

LUXEMBOURG
297 Rue de Reckenthal L-2410 Strassen

2024.06.07 - 2024.06.08

ENTRY LIST BY CLUB

Karate Club Suessem(KC Suessem)					
ID	Sex	Family Name	Given Name	Category	
376	Male	Afonso Marques	Leandro	22 - Kata Male Senior	
377	Male	Afonso Marques	Leandro	19 - Kata Male U18	
378	Female	Rosy Mauricio	Iana	08 - Kata Female U18	
379	Female	Rosy Mauricio	Iana	11 - Kata Female Senior	

Entries: 4

Karate Samurai Dudelange(KS Dudelange)					
ID	Sex	Family Name	Given Name	Category	
380	Male	BALA	Jetnor	Kumite Male Senior +84kg	
381	Male	Borges	Joao	19 - Kata Male U18	
382	Female	PAIVA	Oceane	06 - Kata Female U14	

Entries: 3

Karate Club Niederanven(KC Niederanven)					
ID	Sex	Family Name	Given Name	Category	
383	Male	Arcq Herteleer	Alexander	22 - Kata Male Senior	
384	Male	Arcq Herteleer	Alexander	19 - Kata Male U18	
385	Male	Davies	Alexander	Kumite Male U18 +76kg	
386	Female	Gawellek	Sarah	Kumite Female U18 -59kg	
387	Male	Lichtfous	Jeremy	Kumite Male U12 -45kg	
388	Male	Pierantoni	Matteo	Kumite Male U16 -70kg	
389	Female	Pierantoni	Nora	KUMITE FEMALE U14 +52KG	
390	Male	Serra	Tiago	Kumite Male U18 -76kg	
391	Female	Serra Rodrigues	Ines	Kumite Female U12 -35kg	
392	Male	Wagener	Mathis	Kumite Male U12 +45kg	

Entries: 10

KC Walfer(KC Walfer)					
ID	Sex	Family Name	Given Name	Category	
393	Female	Baldeon	Amazona	06 - Kata Female U14	
394	Female	Blau	Chloé	06 - Kata Female U14	
395	Female	Coquillard	Elise	07 - Kata Female U16	
396	Female	Coquillard	Elise	Kumite Female U16 -47kg	
397	Female	Cornet	Marissa	KUMITE FEMALE U12 -30KG	
398	Female	Cornet	Maxine	Kumite female U14 - 42kg	
399	Female	Cornet	Maxine	06 - Kata Female U14	
400	Female	Durrer	Maya	Kumite Female U12 -35kg	
401	Female	Durrer	Nahima	KUMITE FEMALE U14 -52KG	
402	Female	Durrer	Nahima	06 - Kata Female U14	
403	Female	Els	Noémie	06 - Kata Female U14	
404	Female	Intini Raffaelli	Lara	KUMITE FEMALE U14 -47KG	
405	Female	Intini Raffaelli	Lara	06 - Kata Female U14	
406	Male	Ketter	Maurice	Kumite Male U12 -35kg	
407	Male	Kiesgen	Jimmy	Kumite Male Senior -67kg	
408	Male	Kiesgen	Jimmy	Kumite Male U21 - 67kg	

Lion Cup 2024 Luxembourg

LUXEMBOURG
297 Rue de Reckenthal L-2410 Strassen

2024.06.07 - 2024.06.08

ENTRY LIST BY CLUB

🇱🇺 KC Walfer(KC Walfer)					
ID	Sex	Family Name	Given Name	Category	
409	Male	Le Moigne	Yvan	Kumite Male U16 -52kg	
410	Male	Mineiro	Jairo	Kumite Male U12 -45kg	
411	Female	Olafsson	Elena	Kumite Female U16 +61KG	
412	Female	Parois	Allegra	KUMITE FEMALE U12 -30KG	
413	Male	Rollinger	Henry	Kumite Male U12 -35kg	
414	Female	Szabo	Malna	Kumite Female U18 -48kg	
415	Male	Tashchuk	Oleh	Kumite Male U12 +45kg	
416	Female	Vanaudenhove	Victoria	KUMITE FEMALE U12 -30KG	
417	Male	Vatamaniuk	Artem	Kumite Male U12 -35kg	
418	Female	Warling	Jenny	Kumite Female Senior -55 kg	

Entries: 26

🇳🇱 NETHERLANDS					
🇳🇱 Budoschool Kai Sei(Kai Sei)					
ID	Sex	Family Name	Given Name	Category	
419	Male	Mulder	Stan	Kumite Male U14 +50kg	
420	Male	Peschier	Kyanu	KUMITE MALE U14 -45kg	
421	Male	Werner	Ruben	KUMITE MALE U14 -45kg	
422	Male	Werner	Stijn	Kumite Male U12 -35kg	
423	Female	Zollner	Kimberley	Kumite Female Senior +68kg	

Entries: 5

🇳🇱 BVL Fighting(NETHERLAND)					
ID	Sex	Family Name	Given Name	Category	
424	Female	van Bommel	Ise	KUMITE FEMALE U14 -52KG	

Entries: 1

🇳🇱 Choku-Zaandam(Choku 075)					
ID	Sex	Family Name	Given Name	Category	
425	NED02636	Female	de Haan	Fama	Kumite Female U18 -53kg
426		Female	Göktekin	Simla	Kumite Female U21 - 55kg
427		Female	Göktekin	Simla	Kumite Female Senior -55 kg
428	NED02642	Female	Horsmans	Joanna	Kumite Female U21 - 61kg
429	NED02642	Female	Horsmans	Joanna	Kumite Female Senior -61kg
430		Male	Kaya	Fatih	Kumite Male U12 +45kg
431		Female	Koop	Quinty	Kumite Female U16 -54kg
432		Male	Narcicegi	Tan	Kumite Male U12 -45kg
433	NED02681	Female	Telles	Jenna	Kumite Female Senior +68kg
434	NED02681	Female	Telles	Jenna	Kumite Female U21 + 68kg
435		Male	Wattilete	Gerson	Kumite Male U21 -75kg
436		Male	Wattilete	Gerson	Kumite Male Senior -75kg

Entries: 12

Lion Cup 2024 Luxembourg

LUXEMBOURG
297 Rue de Reckenthal L-2410 Strassen

2024.06.07 - 2024.06.08

ENTRY LIST BY CLUB

 Geoffrey Berens Karate Academy(GBKA)					
ID	Sex	Family Name	Given Name	Category	
437	Male	Boudewijns	Dennis	Kumite Male U21 -75kg	
438	Male	Boudewijns	Dennis	Kumite Male Senior -75kg	
439	Female	Lepez	Darla	Kumite Female U16 -47kg	
440	Male	Lepez	Devon	Kumite Male U16 -57kg	
441	Male	Saeijs	Benjamin	Kumite Male U16 -57kg	

Entries: 5

 Karate Moerdijk(KM)					
ID	Sex	Family Name	Given Name	Category	
442	Female	van den Brand	Julie	Kumite Female U21 - 55kg	
443	Female	van den Brand	Julie	Kumite Female Senior -55 kg	
444	Male	Volders	Joshua	Kumite Male U12 -45kg	

Entries: 3

 Karate Mossel-Boot(MOSSEL)					
ID	Sex	Family Name	Given Name	Category	
445	Female	Landman	Merel	Kumite Female Senior -61kg	
446	Male	Moerkerk van	Dylan	Kumite Male Senior -75kg	
447	Male	Moerkerk van	Joel	Kumite Male Senior +84kg	

Entries: 3

 Karate team Sonnema(KTS)					
ID	Sex	Family Name	Given Name	Category	
448	Male	Bagdja	Benaya	19 - Kata Male U18	

Entries: 1

 Karate Team Utrecht(KTU)					
ID	Sex	Family Name	Given Name	Category	
449	Female	Mezraui	Dounia Sofia	Kumite Female U16 -47kg	
450	Male	Mezraui	Omar	Kumite Male U18 -76kg	
451	Female	Suurmond	Zoë	Kumite Female U21 - 68kg	
452	Male	van Woudenberg	Mika	Kumite Male U18 +76kg	

Entries: 4

 Karate-Do Buitenveldert (KB)					
ID	Sex	Family Name	Given Name	Category	
453	Female	Beets	Caitlin	11 - Kata Female Senior	
454	Female	Steenhuijsen	Eva	09 - Kata Female U21	
455	Female	Steenhuijsen	Eva	11 - Kata Female Senior	
456	Female	Wu	Lisa	09 - Kata Female U21	
457	Female	Wu	Lisa	11 - Kata Female Senior	

Entries: 5

Lion Cup 2024 Luxembourg

LUXEMBOURG
297 Rue de Reckenthal L-2410 Strassen

2024.06.07 - 2024.06.08

ENTRY LIST BY CLUB

KarateKenamju Haarlem(KarateKenamju)					
ID	Sex	Family Name	Given Name	Category	
458	Male	Enthoven	Scott	KUMITE MALE U14 -45kg	
459	Female	Hout van	Liz	KUMITE FEMALE U18 +66kg	
460	Female	Jong de	Anniek	Kumite Female U16 - 61KG	
461	NED02396	Female	Kakiay	Ashley	Kumite Female U21 - 61kg
462	NED02396	Female	Kakiay	Ashley	Kumite Female Senior -61kg
463	Female	Keulen van	Norah	KUMITE FEMALE U14 -52KG	
464	Male	Leijen	Finn	Kumite Male U14 -50kg	
465	Female	Leurs	Lily	KUMITE FEMALE U14 +52KG	
466	Female	Loek	Isa	KUMITE FEMALE U14 -47KG	
467	Female	Pcholko	Varvara	KUMITE FEMALE U14 -47KG	
468	Male	Persaud	Matthew	Kumite Male U18 -61kg	
469	Male	Persaud	Maxim	Kumite Male U16 -57kg	
470	Female	Polianska	Olena	Kumite Female U16 - 61KG	
471	Female	Polianska	Yuliia	KUMITE FEMALE U14 -47KG	
472	NED2342	Male	Teeffelen van	Sebastiaan	Kumite Male U21 -75kg
473	NED2342	Male	Teeffelen van	Sebastiaan	Kumite Male Senior -75kg
474	Male	Twisk	Patrick	Kumite Male U16 +70kg	
475	Female	Unruh	Eline	Kumite Female U16 -54kg	
476	Female	Unruh	Mirja	Kumite Female U18 -59kg	

Entries: 19

Karateschool Alken(R. Alken)					
ID	Sex	Family Name	Given Name	Category	
477	Male	Essers	Reinier	KUMITE MALE U14 -45kg	
478	Male	Gotwalt	Jesaja	Kumite Male U12 -45kg	
479	Male	Lebens	Jax	Kumite Male U14 -50kg	

Entries: 3

Karateschool Bu Shin Kan(BuShinKan)					
ID	Sex	Family Name	Given Name	Category	
480	Male	van der Heijden	Luca	22 - Kata Male Senior	
481	Male	van der Heijden	Luca	19 - Kata Male U18	

Entries: 2

Karateschool Fightin Nabil(KSFN, NED)					
ID	Sex	Family Name	Given Name	Category	
482	Female	Achghouyab	Lyna	Kumite Female U16 -47kg	
483	Male	Achghouyab	Samy	Kumite Male U18 -61kg	
484	Male	Arbaj	Badr Din	Kumite Male U14 -40kg	
485	Female	Bensalaf	Israe	Kumite Female U16 -54kg	
486	Male	Blumink	Levy	Kumite Male U16 -70kg	
487	Female	Bohoudi	Amani	Kumite Female U12 +40kg	
488	Male	Bohoudi	Ilyas	Kumite Male U14 +50kg	
489	Female	Bohoudi	Inssaf	Kumite female U14 - 42kg	
490	Male	Bohoudi	Issam	Kumite Male U14 +50kg	

Lion Cup 2024 Luxembourg

LUXEMBOURG
297 Rue de Reckenthal L-2410 Strassen

2024.06.07 - 2024.06.08

ENTRY LIST BY CLUB

Karateschool Fightin Nabil(KSFN, NED)					
ID	Sex	Family Name	Given Name	Category	
491	Female	Bohoudi	Mayssan	Kumite Female U16 - 61KG	
492	Female	Bohoudi	Nada	Kumite Female U16 +61KG	
493	Male	Bohoudi	Naoufal	Kumite Male U18 -76kg	
494	Male	Buduri	Alban	Kumite Male U18 -68kg	
495	Male	Buduri	Arianit	Kumite Male Senior -75kg	
496	Female	Djuric	Jelena	Kumite Female U18 -53kg	
497	Male	El Feddali	Aouab	Kumite Male Senior +84kg	
498	Male	El Jattari	Mohammed Amine	Kumite Male U16 +70kg	
499	Male	El Mourabit	Rayan	Kumite Male Senior -67kg	
500	Male	El Mourabit	Rayan	Kumite Male U21 - 67kg	
501	Male	Elghoul	Yessin	Kumite Male U16 -52kg	
502	Male	Errahouti	Safouan	Kumite Male U12 -45kg	
503	Male	Kamel	Basem	Kumite Male U18 +76kg	
504	Female	Kashash	Nour	Kumite Female U18 -59kg	
505	Female	Kashash	Sham	Kumite Female U12 -40kg	
506	Male	Kashash	Thaer	Kumite Male U16 -57kg	
507	Male	Kashash	Thaer	Kumite Male U16 -63kg	
508	Male	Kharmich	Adam	Kumite Male U16 -52kg	
509	Female	Koetsier	Sanne	Kumite Female Senior +68kg	
510	Female	Lućkin	Ajla	Kumite Female U12 -35kg	
511	Female	Mamadeus	Sennah	Kumite Female U21 - 68kg	
512	Female	Mamadeus	Sennah	Kumite Female Senior -68kg	
513	Male	Mastari	Souhail	Kumite Male Senior -75kg	
514	Male	Meurs	Robin	Kumite Male U16 +70kg	
515	Female	Nassiri	Lyna	Kumite Female U12 -35kg	
516	NED2016	Snel	Lynn	Kumite Female Senior -68kg	
517	Female	Tenzali	Romaissa	KUMITE FEMALE U14 +52KG	
518	Male	Tomson	Max	Kumite Male U12 -45kg	
519	Female	Valk	Imane	KUMITE FEMALE U18 -66KG	
520	Male	van de Nes	Dinand	Kumite Male U14 +50kg	
521	Female	van Wezel	Robin	Kumite Female Senior +68kg	
522	Female	van Wezel	Robin	Kumite Female U21 + 68kg	
523	Male	Van Wijngaarden	Tygo	Kumite Male U16 -57kg	
524	Female	Yalçin	Samina	Kumite Female U21 - 50kg	
525	Female	Yalçin	Samina	Kumite Female Senior -50kg	
526	Male	Zarchid	Moncef	Kumite Male U16 +70kg	

Entries: 45

Rene Smaal Karate(RSK)					
ID	Sex	Family Name	Given Name	Category	
527	Male	Heupink	Timo	Kumite Male U18 -76kg	
528	Female	Kong	Faith	Kumite female U14 - 42kg	
529	Male	Kong	Jeremy	Kumite Male U16 -57kg	
530	Male	Lu	Darrick	Kumite Male U16 -52kg	
531	Female	Lu	Jaimi	Kumite female U14 - 42kg	
532	Male	Rondhuis	Dex	Kumite Male U14 -40kg	

Entries: 6

Lion Cup 2024 Luxembourg

LUXEMBOURG
297 Rue de Reckenthal L-2410 Strassen

2024.06.07 - 2024.06.08

ENTRY LIST BY CLUB

 Sportschool Muilwijk(04-006)					
ID	Sex	Family Name	Given Name	Category	
533	Male	Bezemer	Bradley	Kumite Male U16 -63kg	
534	Male	de Rover	Luke	Kumite Male U16 +70kg	
535	Male	Kouwenhoven	Daan	Kumite Male U18 -68kg	
536	Male	Roubos	Sean	Kumite Male Senior -67kg	
537	Male	Roubos	Sean	Kumite Male U21 - 67kg	

Entries: 5

 Sportschool van den Nieuwendijk(SVDN)					
ID	Sex	Family Name	Given Name	Category	
538	Male	Walrabenstein	Sebastian	Kumite Male Senior -67kg	



Entries: 1

 Sportschool van Laar(SVL)					
ID	Sex	Family Name	Given Name	Category	
539	Female	Veer	Fiane	Kumite Female U16 +61KG	

Entries: 1

 Unity99(Unity99)					
ID	Sex	Family Name	Given Name	Category	
540	Female	Vlieland	Kayleigh	KUMITE FEMALE U14 -47KG	
541	Male	Kaewborisut	Aaron	Kumite Male U14 -50kg	
542	Male	Kaewborisut	Justin	Kumite Male Senior +84kg	
543	Female	Kaewborisut	Lyana	Kumite Female U21 - 61kg	
544	Female	Kaewborisut	Lyana	Kumite Female Senior -61kg	
545	Male	Krijnen	Thomas	Kumite Male U18 -68kg	
546	Female	Limes	lois	Kumite Female U16 -54kg	
547	Male	Overman	Jean-Claude	Kumite Male Senior -84kg	
548	Female	Rozenblad	Adriana M A	KUMITE FEMALE U18 -66KG	
549	Male	Sardjoe Missier	Rohit	Kumite Male U18 -61kg	
550	Male	Stoutjesdijk	Aaron	Kumite Male U14 -50kg	
551	Male	To	Nicolas	Kumite Male U18 -55kg	
552	Male	van der Vliet	Merijn	Kumite Male U18 +76kg	
553	Male	van der Weide	Niek	Kumite Male Senior -67kg	
554	Male	van Kruijing	Flynn	Kumite Male U16 -70kg	
555	Female	Voorduin	Alyssia	Kumite Female U18 -53kg	
556	Male	Werff	Kai	Kumite Male U18 -68kg	
557	Female	Zwanenburg	Robin	KUMITE FEMALE U18 +66kg	

Entries: 18

 NORWAY					
 Sportskarate Drammen(SKD)					
ID	Sex	Family Name	Given Name	Category	
558	Female	Cole	Eirin Kristine	Kumite Female U16 - 61KG	

Lion Cup 2024 Luxembourg

LUXEMBOURG
297 Rue de Reckenthal L-2410 Strassen

2024.06.07 - 2024.06.08

ENTRY LIST BY CLUB

🇱🇺 Sportskarate Drammen(SKD)					
ID	Sex	Family Name	Given Name	Category	
559	Male	Fagerli	Demian	Kumite Male U16 -63kg	
560	Female	Hansen	Celine Marie Walstad	Kumite female U14 - 42kg	
561	Male	Hansen	Henrik Walstad	Kumite Male Senior -60kg	
562	Male	Hansen	Henrik Walstad	Kumite Male U21 - 60kg	
563	Male	Hansen	Martin Walstad	Kumite Male U16 -57kg	
564	Female	Johansen	Madeleine	Kumite Female U16 -54kg	
565	Female	Rasmussen	Maja Knøvl	Kumite Female U21 - 55kg	
566	Female	Rasmussen	Maja Knøvl	Kumite Female Senior -55 kg	

Entries: 9

🇵🇱 POLAND					
🇵🇱 Klub Sportowy Morote(Morote)					
ID	Sex	Family Name	Given Name	Category	
567	Female	Grzakowska	Klaudia	Kumite female U14 - 42kg	
568	Male	Kamornik	Dzmitry	Kumite Male U14 +50kg	
569	Female	Nykolyn	Yuliia	Kumite Female Senior +68kg	
570	Female	Nykolyn	Yuliia	Kumite Female U21 + 68kg	
571	Male	Piłat	Maksym	Kumite Male U14 -40kg	
572	Female	Yakubovska	Valeriia	Kumite Female U16 -54kg	

Entries: 6

🇵🇹 PORTUGAL					
🇵🇹 Centro Budo de Fafe(CBF)					
ID	Sex	Family Name	Given Name	Category	
573	Male	Alves	Lucas	Kumite Male U18 -68kg	
574	Male	Fernandes	Fábio	Kumite Male U21 -84kg/+84kg	
575	Male	Pereira	Leonardo	Kumite Male Senior +84kg	

Entries: 3

🇵🇹 CKMaia(CKMaia)					
ID	Sex	Family Name	Given Name	Category	
576	Female	Carvalho	Lara	Kumite Female U21 - 61kg	
577	Female	Carvalho	Lara	Kumite Female Senior -61kg	
578	Male	PINTO	BRUNO	Kumite Male Senior +84kg	

Entries: 3

🇵🇹 KSPA - PORTUGAL(KSPA)					
ID	Sex	Family Name	Given Name	Category	
579	Male	Ribeiro	Diogo	Kumite Male U18 -68kg	
580	Male	Ribeiro	Francisco	Kumite Male U18 -76kg	

Entries: 2

Lion Cup 2024 Luxembourg

LUXEMBOURG
297 Rue de Reckenthal L-2410 Strassen

2024.06.07 - 2024.06.08

ENTRY LIST BY CLUB

SCOTLAND

FJK-Scotland(FJK-Scotland)

ID	Sex	Family Name	Given Name	Category
581	Male	Morrison	Logan	18 - Kata Male U16
582	Male	Morrison	Logan	Kumite Male U16 -57kg

Entries: 2

SPAIN

Karate Club Funakoshi (Funakoshi)

ID	Sex	Family Name	Given Name	Category
583	Male	Lopes	Ivan	Kumite Male Senior -60kg

Entries: 1

SWEDEN

Gymnastik och Atletklubben Enighet(GAK Enighet)

ID	Sex	Family Name	Given Name	Category
584	Female	Jakesevic	Ivana	KUMITE FEMALE U18 -66KG

Entries: 1

Lunds karateklubb(LKK)

ID	Sex	Family Name	Given Name	Category
585	Male	Hallén	Mario	Kumite Male U18 -76kg

Entries: 1

Shiai IF(Shiai IF)

ID	Sex	Family Name	Given Name	Category
586	Female	Ghinia	Sofia	Kumite Female U16 -54kg

Entries: 1

Turebergs Karateklubb(TKB)

ID	Sex	Family Name	Given Name	Category
587	Female	Sökare	Felicia	11 - Kata Female Senior

Entries: 1

UNITED SPORTCENTER(USC)

ID	Sex	Family Name	Given Name	Category
588	Male	Behtioui	Taha	Kumite Male U18 -61kg

Entries: 1

SWITZERLAND

Lion Cup 2024 Luxembourg

LUXEMBOURG
297 Rue de Reckenthal L-2410 Strassen

2024.06.07 - 2024.06.08

ENTRY LIST BY CLUB

EKTS Lausanne Vuflens(EKTS Vaud)					
ID	Sex	Family Name	Given Name	Category	
589	SUI SD47119	Female	SCHEDDEL	Kaena	06 - Kata Female U14
590	SUI02236	Male	SCHEDDEL	Keni	20 - Kata Male U21
591	SUI02236	Male	SCHEDDEL	Keni	22 - Kata Male Senior

Entries: 3

Elson Sport & Karate(Elson Sport)					
ID	Sex	Family Name	Given Name	Category	
592		Male	Kabashi	Elson Jason	Kumite Male U18 -61kg
593		Male	Kabashi	John	Kumite Male U21 -84kg/+84kg
594		Male	Kabashi	John	Kumite Male Senior +84kg
595		Male	Leuenberger	Maximilian	Kumite Male U18 -68kg
596		Male	Sanarica	Niccolo	Kumite Male U18 -76kg

Entries: 5

Goju Kan Bern(Goju Kan Bern)					
ID	Sex	Family Name	Given Name	Category	
597		Male	Schertenleib	Lars	20 - Kata Male U21
598		Male	Schertenleib	Lars	22 - Kata Male Senior

Entries: 2

Karate Club Fribourg(KC Fribourg)					
ID	Sex	Family Name	Given Name	Category	
599		Male	DI GIOIA	Raffaele	Kumite Male Senior -75kg
600		Male	KARLEN	Théo	Kumite Male U18 -68kg
601		Male	OBERSON	Antoine	Kumite Male U21 -75kg
602		Male	OBERSON	Antoine	Kumite Male Senior -75kg
603		Female	VERGA	Ludivine	Kumite female U14 - 42kg

Entries: 5

Karate Club Valais(KC Valais)					
ID	Sex	Family Name	Given Name	Category	
604		Male	Alves Da Gloria	Patrick	Kumite Male U16 -52kg
605		Male	Lorenz	Swan	Kumite Male U18 -68kg
606		Male	Musa	Lorian	Kumite Male U14 -50kg

Entries: 3

Karate Do Brugg(KDB)					
ID	Sex	Family Name	Given Name	Category	
607		Male	Baranyi	Barnabas	Kumite Male U21 -75kg
608		Male	Baranyi	Barnabas	Kumite Male Senior -75kg
609		Male	Buhurcu	Jiyan	Kumite Male U18 -76kg
610		Female	Caluori	Svenja	KUMITE FEMALE U18 -66KG
611		Male	Dobberstein	Lennox	Kumite Male Senior -84kg

Lion Cup 2024 Luxembourg

LUXEMBOURG
297 Rue de Reckenthal L-2410 Strassen

2024.06.07 - 2024.06.08

ENTRY LIST BY CLUB

Karate Do Brugg(KDB)					
ID	Sex	Family Name	Given Name	Category	
612	Male	Dobberstein	Lennox	Kumite Male U21 -84kg/+84kg	
613	Female	Erol	Beril	Kumite Female U16 +61KG	
614	Female	Fleischmann	Alany Alexa	Kumite Female U16 -54kg	
615	Male	Lüthy	Corsin Dion	18 - Kata Male U16	
616	Male	Lüthy	Corsin Dion	Kumite Male U16 -52kg	
617	Male	Mateus Gomes	Cristiano	18 - Kata Male U16	
618	Male	Mateus Gomes	Cristiano	Kumite Male U16 -52kg	
619	Male	Mateus Gomes	Leonardo	18 - Kata Male U16	
620	Male	Mateus Gomes	Leonardo	Kumite Male U16 -52kg	
621	Female	Vignogna	Vivien	Kumite Female U18 -53kg	
622	Male	Vranjes	Andrej	Kumite Male U21 -75kg	
623	Male	Vranjes	Andrej	Kumite Male Senior -75kg	

Entries: 17

Karate Emme(SWITZERLAND)					
ID	Sex	Family Name	Given Name	Category	
624	Female	Gallimore	Kim	11 - Kata Female Senior	
625	Female	Gallimore	Kim	08 - Kata Female U18	
626	Male	Mischler	Kevin	22 - Kata Male Senior	
627	Male	Mischler	Kevin	19 - Kata Male U18	
628	Female	Ritz	Lila	08 - Kata Female U18	
629	Female	Ritz	Lila	11 - Kata Female Senior	
630	Female	Ritz	Maia	07 - Kata Female U16	

Entries: 7

Karatecenter Reto Kern Kreuzlingen(KCRK)					
ID	Sex	Family Name	Given Name	Category	
631	Female	Frischknecht	Jessica	Kumite Female U16 -47kg	
632	Female	Huber	Lea	Kumite Female U21 - 50kg	
633	Female	Huber	Lea	Kumite Female Senior -50kg	
634	Female	Näf	Sylvie	KUMITE FEMALE U14 -47KG	
635	SUI02567	Pelladoni	Gina	08 - Kata Female U18	
636	Male	Sieber	Elija	Kumite Male U16 -63kg	
637	Male	Stein	Kilian Johan	Kumite Male U14 -40kg	
638	Female	von Klass	Melissa	Kumite Female U16 -47kg	
639	Female	Widmer	Alisha	Kumite female U14 - 42kg	

Entries: 9

Karatedo Lyss-Aarberg(KDLyss)					
ID	Sex	Family Name	Given Name	Category	
640	Male	Battistel	Florin	KUMITE MALE U14 -45kg	
641	Female	Battistel	Julia	KUMITE FEMALE U12 -30KG	
642	Female	Bosshard	Lea Marie	Kumite Female U21 - 61kg	
643	Female	Bosshard	Lea Marie	Kumite Female Senior -61kg	
644	Female	Burri	Liliane	Kumite Female U21 - 61kg	

Lion Cup 2024 Luxembourg

LUXEMBOURG
297 Rue de Reckenthal L-2410 Strassen

2024.06.07 - 2024.06.08

ENTRY LIST BY CLUB

 Karatedo Lyss-Aarberg(KDLyss)					
ID	Sex	Family Name	Given Name	Category	
645	Female	Burri	Liliane	Kumite Female Senior -61kg	
646	Female	Gaus	Anja	Kumite Female U16 -54kg	
647	Female	Gnägi	Naya	KUMITE FEMALE U14 -47KG	
648	Male	Jost	Ruben	Kumite Male Senior -67kg	
649	Male	Jost	Ruben	Kumite Male U21 - 67kg	
650	Female	Kanesan	Alycia	Kumite female U14 - 42kg	
651	Male	Kanesan	Sujash	Kumite Male U16 -52kg	
652	Male	Krähenbühl	Lian	Kumite Male U14 -50kg	
653	Female	Mühlemann	Noemi Emma	Kumite Female U16 - 61KG	
654	Female	Pulver	Melina	Kumite Female U16 -54kg	
655	Female	Radjenovic	Nina	Kumite Female Senior -61kg	
656	Male	Roncagalli	Elia	Kumite Male U16 -63kg	
657	Female	Streit	Kim Lara	Kumite Female U18 -59kg	
658	Female	Streit	Mila Chiara	Kumite Female U16 -47kg	
659	Female	Tscharner	Anais	Kumite Female U16 -54kg	
660	Male	Tscharner	Loan	Kumite Male U18 -68kg	
661	Male	Vuong	Levin	Kumite Male U14 -40kg	

Entries: 22

 karateschule sursee(k.s.sursee)					
ID	Sex	Family Name	Given Name	Category	
662	Female	Aregger	Leila	Kumite Female U12 +40kg	
663	Male	Bosch	David	Kumite Male U18 -55kg	
664	Male	Bosch	David	19 - Kata Male U18	
665	Female	Büchler	Sofia	KUMITE FEMALE U14 -47KG	
666	Male	Delianidis	Ioannis	Kumite Male U12 -45kg	
667	Female	Gerber	Yara	Kumite Female U16 -47kg	
668	Female	Kaufmann	Fabienne	Kumite Female Senior +68kg	
669	Male	Ouk	Jayden	Kumite Male U12 -35kg	
670	Female	Sellami	Inshirah	Kumite Female U16 -47kg	
671	Female	Staub	Nia	KUMITE FEMALE U18 -66KG	
672	Female	Steiner	Solène	Kumite female U14 - 42kg	
673	Female	Steiner	Solène	06 - Kata Female U14	

Entries: 12

 Karaté Club Jaguar Vallorbe(KCJ)					
ID	Sex	Family Name	Given Name	Category	
674	Male	Hachem	Elie	Kumite Male U12 -45kg	
675	Male	Poncet	Arthur	Kumite Male U16 -63kg	

Entries: 2

 Kenseikan Karate-Do Thun(Ken Thun)					
ID	Sex	Family Name	Given Name	Category	
676	Male	Ott	Simon	22 - Kata Male Senior	
677	Male	Ott	Simon	Kumite Male U18 -68kg	

Lion Cup 2024 Luxembourg

LUXEMBOURG
297 Rue de Reckenthal L-2410 Strassen

2024.06.07 - 2024.06.08

ENTRY LIST BY CLUB

Kenseikan Karate-Do Thun(Ken Thun)					
ID	Sex	Family Name	Given Name	Category	
678	Male	Ott	Simon	19 - Kata Male U18	
679	Female	Tschanz	Olivia	09 - Kata Female U21	
680	Female	Tschanz	Olivia	11 - Kata Female Senior	

Entries: 5

Neuchâtel Karaté-do(NKD)					
ID	Sex	Family Name	Given Name	Category	
681	Female	Bonjour	Pauline	Kumite Female Senior +68kg	

Entries: 1

Quirici2020(Qu20)					
ID	Sex	Family Name	Given Name	Category	
682	Female	Boutracit	Aïcha	Kumite Female U21 - 50kg	
683	Female	Boutracit	Aïcha	Kumite Female Senior -50kg	
684	Female	Boutracit	Marwa	Kumite Female U12 -35kg	
685	Female	Dontsis	Zoi	KUMITE FEMALE U12 -30KG	
686	IRI2137	Quirici	Melika	Kumite Female Senior -61kg	
687	Female	Rose Nolet	Lily	Kumite Female Senior +68kg	
688	Female	Rose Nolet	Lily	Kumite Female U21 + 68kg	
689	Female	Rose Nolet	Lily	Kumite Female Senior -61kg	
690	Female	Wohlgemuth	Naiya Elin	Kumite Female U21 - 61kg	
691	Female	Wohlgemuth	Naiya Elin	Kumite Female Senior -61kg	

Entries: 10

Shinsei Kan Lenzburg(ShinseiKan)					
ID	Sex	Family Name	Given Name	Category	
692	Male	Del Medico	Dominic	Kumite Male U16 -52kg	
693	Male	Del Medico	Manuel	Kumite Male U21 -75kg	
694	Male	Del Medico	Manuel	Kumite Male Senior -75kg	
695	Male	Gloor	Leon	Kumite Male U14 +50kg	
696	Male	Gloor	Leon	Kumite Male U14 -50kg	
697	Female	Gres	sara	Kumite Female U16 - 61KG	
698	Male	Meier	Nikita	Kumite Male U12 -45kg	
699	Female	Oymak	Almina	Kumite Female U16 -47kg	
700	Male	Oymak	Yusuf	Kumite Male U18 -68kg	
701	Female	Schwerzmann	Mona	KUMITE FEMALE U12 -30KG	
702	Male	Sivarasalingam	Laarushan	Kumite Male U14 -40kg	

Entries: 11

SSKF Karate Team(SSKF Karate Team)					
ID	Sex	Family Name	Given Name	Category	
703	Male	Berisha	Dren	Kumite Male U14 +50kg	
704	Female	Bürki	Danicha	Kumite Female U18 -59kg	
705	Male	Cosse	Etienne	Kumite Male U18 -55kg	
706	Female	Dumitras	Pia	Kumite Female U16 -54kg	

Lion Cup 2024 Luxembourg

LUXEMBOURG
297 Rue de Reckenthal L-2410 Strassen

2024.06.07 - 2024.06.08

ENTRY LIST BY CLUB

SSKF Karate Team(SSKF Karate Team)					
ID	Sex	Family Name	Given Name	Category	
707	Female	Gibril	Hiba	Kumite Female U16 - 61KG	
708	Male	Giess	Thierry	Kumite Male U14 +50kg	
709	Female	Payziner	Asya	Kumite Female U12 -40kg	
710	Female	Payziner	Serena	Kumite Female U16 -47kg	
711	Female	Sanneh	Fatumata	Kumite Female U16 -54kg	
712	Male	Schmid	Samuel	Kumite Male U21 - 60kg	
713	Male	Schmid	Samuel	Kumite Male Senior -60kg	
714	Male	Solomon	Merih	KUMITE MALE U14 -45kg	
715	Male	Sparer	Nico	Kumite Male U21 -75kg	
716	Male	Sparer	Nico	Kumite Male Senior -75kg	
717	Male	Tiefenauer	Jonathan	Kumite Male U14 -50kg	
718	Female	Tiefenauer	Lena	KUMITE FEMALE U14 +52KG	
719	Male	Torres	Steven	Kumite Male U18 -68kg	
720	Male	Zendeli	Meriton	Kumite Male U12 +45kg	

Entries: 18

Swiss Karate Union(SKU)					
ID	Sex	Family Name	Given Name	Category	
721	Female	Alari	Susan	Kumite Female U16 +61KG	
722	Male	Alfonso Perez	Eloy	Kumite Male U14 -50kg	
723	Female	Arifagic	Almina	Kumite Female U16 - 61KG	
724	Male	Bandelier	Mathis	Kumite Male U18 +76kg	
725	Female	Bonny	Shan'ia	Kumite Female Senior +68kg	
726	Female	Bonny	Shan'ia	Kumite Female U21 + 68kg	
727	Male	Büttiker	Antoine	Kumite Male U18 -55kg	
728	Male	Cajöri	Milo	19 - Kata Male U18	
729	Female	Campell	Larissa	07 - Kata Female U16	
730	Male	Carvalho Pereira	Rafael	Kumite Male U12 -45kg	
731	Male	Daboubi	Yassine	Kumite Male U18 -68kg	
732	Male	Debost	Gaspard	Kumite Male U18 -61kg	
733	Female	Delay	Sara	08 - Kata Female U18	
734	Male	Dos Santos	Samuel	18 - Kata Male U16	
735	Male	Dos Santos	Samuel	Kumite Male U16 -70kg	
736	Female	Eiselt	Zoe	11 - Kata Female Senior	
737	Female	Eiselt	Zoe	08 - Kata Female U18	
738	Female	Fortunato	Emma	11 - Kata Female Senior	
739	Female	Fortunato	Emma	08 - Kata Female U18	
740	Male	Giaquinto	Daniele	Kumite Male U16 -52kg	
741	Female	Golubovic	Inija	06 - Kata Female U14	
742	Male	Graf	Ilias	Kumite Male Senior +84kg	
743	Female	Guye	Nina	Kumite Female U18 -59kg	
744	Male	Halbich	Nicolas	Kumite Male U18 -76kg	
745	Male	Limacher	Ramon	17 - Kata Male U14	
746	Male	Limacher	Ramon	Kumite Male U14 -50kg	
747	Male	Maillard	Timéo	Kumite Male U12 -45kg	
748	Female	Michaud	Zoé	06 - Kata Female U14	

Lion Cup 2024 Luxembourg

LUXEMBOURG
297 Rue de Reckenthal L-2410 Strassen

2024.06.07 - 2024.06.08

ENTRY LIST BY CLUB

Swiss Karate Union(SKU)					
ID	Sex	Family Name	Given Name	Category	
749	Female	Monnier	Cassandra	07 - Kata Female U16	
750	Male	Patricio-Clémont	Johan	Kumite Male U16 -52kg	
751	Female	Paul-Jacques	Juline	Kumite Female U18 -53kg	
752	Male	Pedro	Théo	Kumite Male U18 -76kg	
753	Female	Redzic	Esma	Kumite Female U16 +61KG	
754	Male	Rouèche	David	Kumite Male Senior +84kg	
755	Male	Rouèche	David	Kumite Male U21 -84kg/+84kg	
756	Female	Sigillò	Anastasia	KUMITE FEMALE U14 -52KG	
757	Female	Sigillò	Anastasia	06 - Kata Female U14	
758	Male	Soliaryk	Platon	18 - Kata Male U16	
759	Male	Soliaryk	Platon	Kumite Male U16 -57kg	
760	Male	Tawfik	Salim	Kumite Male Senior -75kg	
761	Male	Vogel	Kaspar	19 - Kata Male U18	
762	Male	Vogel	Kaspar	Kumite Male U18 -76kg	
763	Female	Weiss	Tiffany	06 - Kata Female U14	
764	Female	Weiss	Tiffany	KUMITE FEMALE U14 +52KG	
765	Male	Wenger	Levin	Kumite Male U18 -61kg	
766	Female	Wyssbrod	Selin	Kumite Female U18 -48kg	
767	Female	Zayed	Fatima	11 - Kata Female Senior	
768	Female	Zayed	Fatima	09 - Kata Female U21	
769	Male	Zecca	Donato	Kumite Male Senior +84kg	
770	Female	Zecca	Kassandra	Kumite Female U12 +40kg	
771	Male	Zecca	Lucas	Kumite Male U16 -52kg	
772	Female	Özdemir	Demet	Kumite Female U16 -47kg	

Entries: 52

TUNISIA					
Ettaleb(Ettaleb)					
ID	Sex	Family Name	Given Name	Category	
773	Female	Ettaleb	Meriam	KUMITE FEMALE U18 +66kg	

Entries: 1

WALES					
Wales Karate-Do Wadokai- BIKO(WKW - BIKO)					
ID	Sex	Family Name	Given Name	Category	
774	Male	Lewis	Caian	17 - Kata Male U14	
775	Female	Lewis	Chloe	11 - Kata Female Senior	
776	Female	Lewis	Chloe	08 - Kata Female U18	

Entries: 3

Total Entries:776

Lion Cup 2024 Luxembourg

LUXEMBOURG
297 Rue de Reckenthal L-2410 Strassen

2024.06.07 - 2024.06.08

Statistics

Participating Countries: 21

Participating Regions: 15

Participating
Team/Clubs: 125

	Competitors	Entries
Female	297	357
Male	354	419
Total	651	776

Entries per Category	Entries	Teams
06 - Kata Female U14	20	-
07 - Kata Female U16	13	-
08 - Kata Female U18	19	-
09 - Kata Female U21	8	-
11 - Kata Female Senior	23	-
17 - Kata Male U14	11	-
18 - Kata Male U16	15	-
19 - Kata Male U18	17	-
20 - Kata Male U21	4	-
22 - Kata Male Senior	21	-
KUMITE FEMALE U12 -30KG	14	-
KUMITE FEMALE U14 +52KG	11	-
KUMITE FEMALE U14 -47KG	13	-
KUMITE FEMALE U14 -52KG	9	-
KUMITE FEMALE U18 +66kg	3	-
KUMITE FEMALE U18 -66KG	8	-
KUMITE MALE U14 -45kg_	12	-
Kumite Female Senior +68kg	10	-
Kumite Female Senior -50kg	7	-
Kumite Female Senior -55 kg	8	-
Kumite Female Senior -61kg	15	-
Kumite Female Senior -68kg	7	-
Kumite Female U12 +40kg	8	-
Kumite Female U12 -35kg	8	-
Kumite Female U12 -40kg	9	-
Kumite Female U16 +61KG	10	-
Kumite Female U16 - 61KG	19	-
Kumite Female U16 -47kg	22	-
Kumite Female U16 -54kg	21	-
Kumite Female U18 -48kg	3	-

Lion Cup 2024 Luxembourg

LUXEMBOURG
297 Rue de Reckenthal L-2410 Strassen

2024.06.07 - 2024.06.08

Statistics

Kumite Female U18 -53kg	11	-
Kumite Female U18 -59kg	12	-
Kumite Female U21 + 68kg	5	-
Kumite Female U21 - 50kg	8	-
Kumite Female U21 - 55kg	4	-
Kumite Female U21 - 61kg	9	-
Kumite Female U21 - 68kg	4	-
Kumite Male Senior +84kg	11	-
Kumite Male Senior -60kg	9	-
Kumite Male Senior -67kg	15	-
Kumite Male Senior -75kg	25	-
Kumite Male Senior -84kg	9	-
Kumite Male U12 +45kg	7	-
Kumite Male U12 -35kg	17	-
Kumite Male U12 -45kg	22	-
Kumite Male U14 +50kg	14	-
Kumite Male U14 -40kg	19	-
Kumite Male U14 -50kg	17	-
Kumite Male U16 +70kg	10	-
Kumite Male U16 -52kg	27	-
Kumite Male U16 -57kg	13	-
Kumite Male U16 -63kg	14	-
Kumite Male U16 -70kg	11	-
Kumite Male U18 +76kg	7	-
Kumite Male U18 -55kg	9	-
Kumite Male U18 -61kg	14	-
Kumite Male U18 -68kg	19	-
Kumite Male U18 -76kg	12	-
Kumite Male U21 - 60kg	6	-
Kumite Male U21 - 67kg	10	-
Kumite Male U21 -75kg	16	-
Kumite Male U21 -84kg/+84kg	6	-
Kumite female U14 - 42kg	16	-
Totals:	776	0

06 - KATA FEMALE U14

Lion Cup 2024 Luxembourg

ENTRIES BY WEIGHT CATEGORY
06 - Kata Female U14

As of 8 JUN 2024

NOC Code	Gender	Name	Seeding
EGY	F	Gaballa Rama	
FRA	F	CEDOLIN Clara	
FRA	F	Defrance Inès	
FRA	F	RIO Iliana	
FRA	F	Yapoby Camerone	
LUX	F	Baldeon Amazona	
LUX	F	Blau Chloé	
LUX	F	Cornet Maxine	
LUX	F	Costa Nuria	
LUX	F	Durrer Nahima	
LUX	F	Els Noémie	
LUX	F	Gomes Solara	
LUX	F	Intini Raffaelli Lara	
LUX	F	PAIVA Oceane	
SUI	F	Golubovic Inija	
SUI	F	Michaud Zoé	
SUI	F	SCHEDDEL Kaena	
SUI	F	Sigillò Anastasia	
SUI	F	Steiner Solène	
SUI	F	Weiss Tiffany	

06 - Kata Female U14

Lion Cup 2024 Luxembourg, 297 Rue de Reckenthal L-2410 Strassen, LUX

2024-06-07

Tatami
4 17:30

Pool
1/2

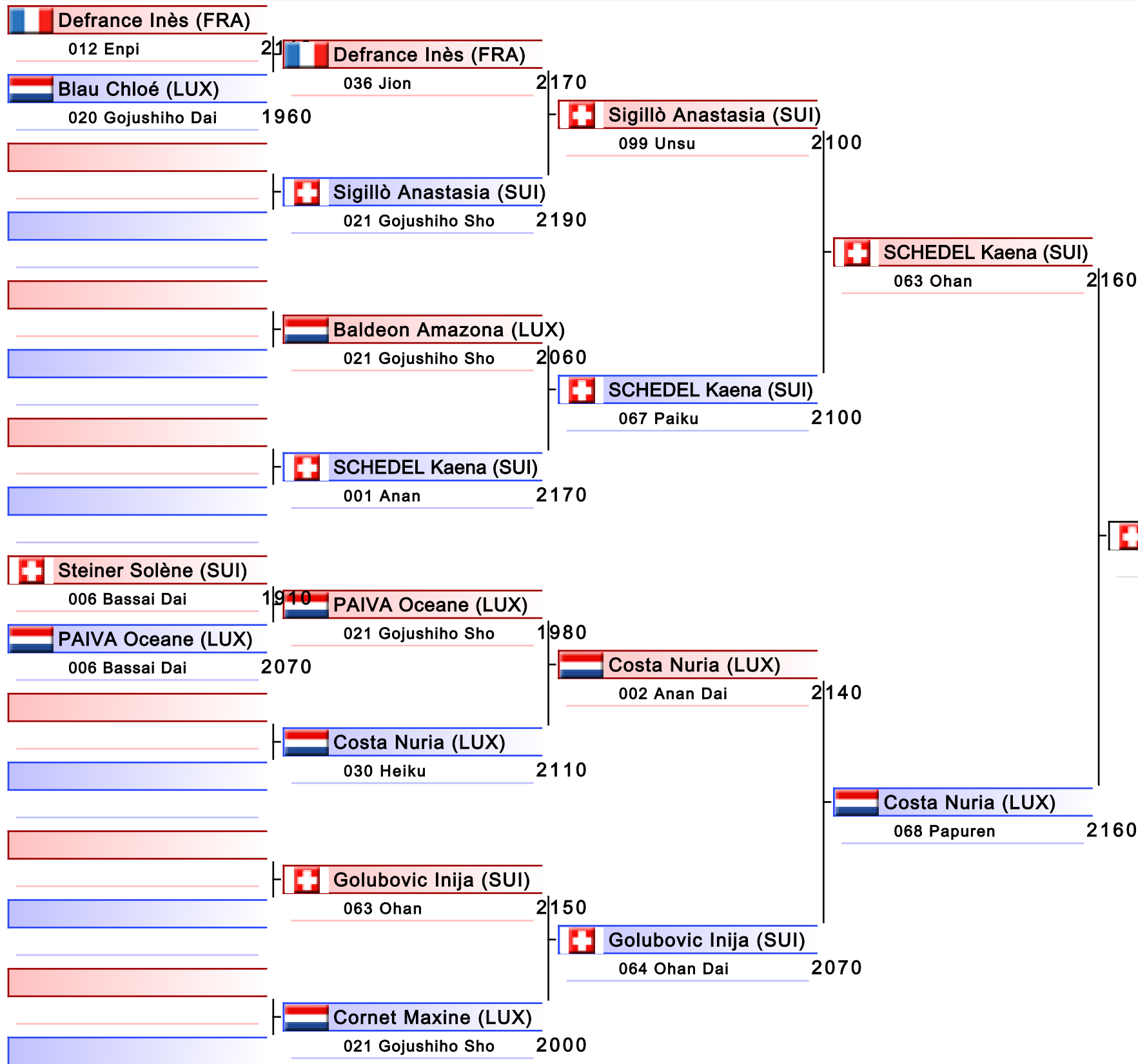

1. SCHEDEL KAENA (SUI)
2. WEISS TIFFANY (SUI)
3. CEDOLIN CLARA (FRA)
3. SIGILLÒ ANASTASIA (SUI)
5. MICHAUD ZOÉ (SUI)
5. COSTA NURIA (LUX)
7. ELS NOÉMIE (LUX)
7. BALDEON AMAZONA (LUX)

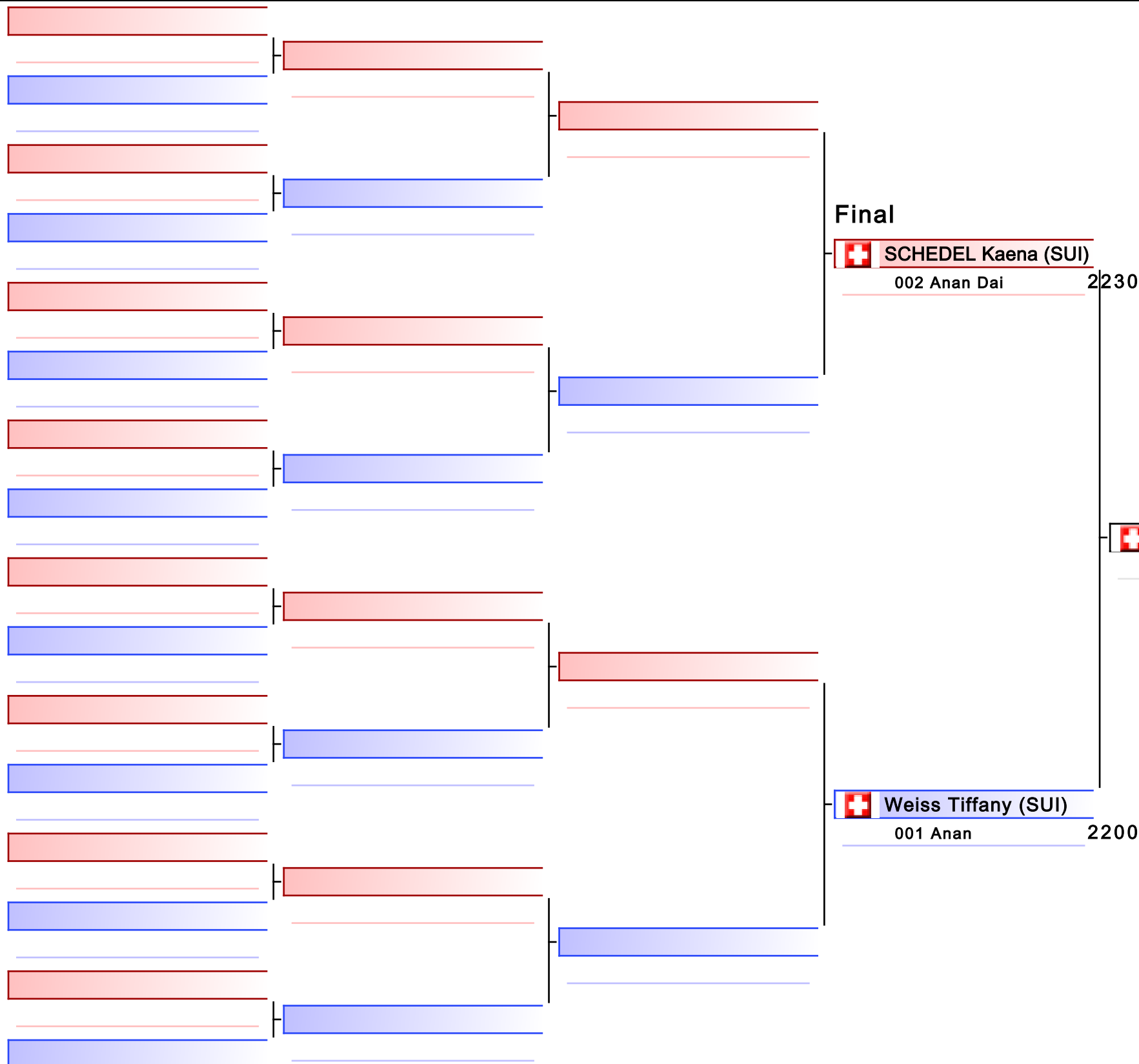

1. SCHEDEL KAENA (SUI)
2. WEISS TIFFANY (SUI)
3. CEDOLIN CLARA (FRA)
3. SIGILLÒ ANASTASIA (SUI)
5. MICHAUD ZOÉ (SUI)
5. COSTA NURIA (LUX)
7. ELS NOÉMIE (LUX)
7. BALDEON AMAZONA (LUX)

06 - Kata Female U14

Lion Cup 2024 Luxembourg

2024-06-07

Tatami
5 18:15

Pool
2

(c)sportdata GmbH & Co KG 2000-2024 (2024-06-08 18:41) v 10.1.0 build 1 (2024-01-24 23:23 CET) License: Online_Event_ID-7672_LionCup2024Luxembourg (expire 2024-06-21)

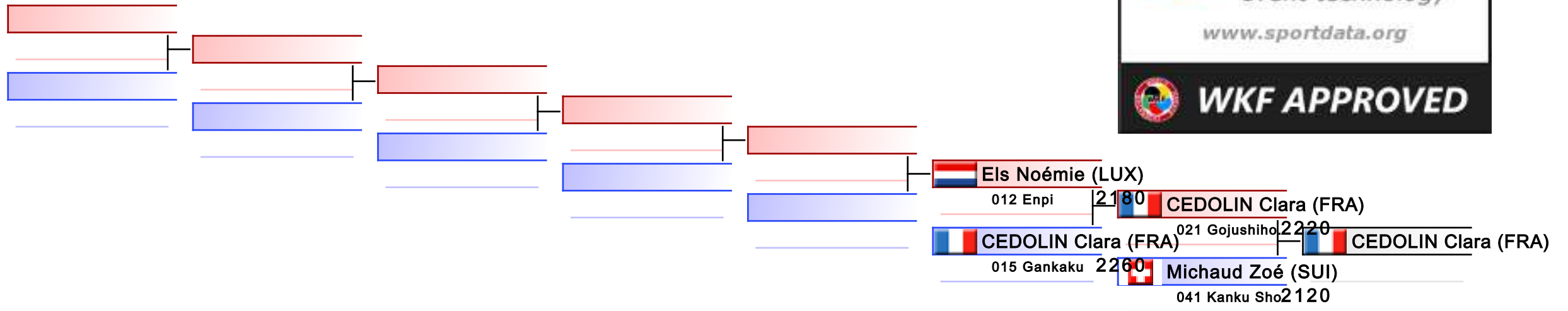

REPECHAGE: (2)

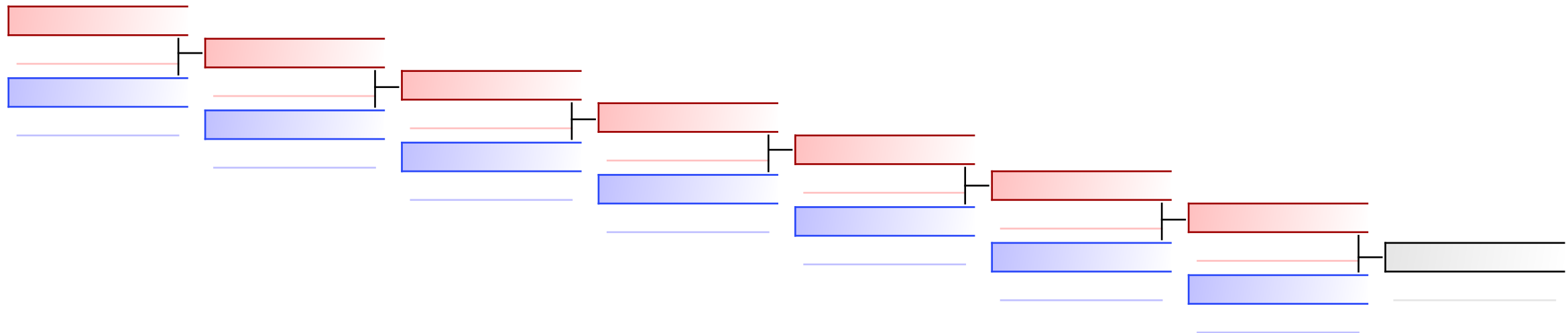

Lion Cup 2024 Luxembourg

297 Rue de Reckenthal L-2410 Strassen, LUXEMBOURG

Court Nr.	1	Pool	1	Date	2024-06-08	Field Position	49
RED				BLUE			
NOC	DEFRANCE INS (FRA)			NOC	BLAU CHLO (LUX)		
Category	06 - Kata Female U14						
3 Points	2 Points	1 Point	Score	1 Point	2 Points	3 Points	
			21 : 19				
Penatlity				Penatlity			
			21.1:1 ..				
WINNER			Total				

POINTS

Decision of Superiority

Judge 1	Judge 2	Judge 3	Judge 4	Judge 5	Judge 6	Judge 7	Referee

Name _____

Signature _____

Lion Cup 2024 Luxembourg

297 Rue de Reckenthal L-2410 Strassen, LUXEMBOURG

Court Nr.	1	Pool	1	Date	2024-06-08	Field Position	53
RED				BLUE			
NOC	STEINER SOLNE (SUI)			NOC	PAIVA OCEANE (LUX)		
Category	06 - Kata Female U14						
3 Points	2 Points	1 Point	Score	1 Point	2 Points	3 Points	
			19 : 20				
Penatlity					Penatlity		
				19.1:2 ..			
				Total	WINNER		

POINTS

Decision of Superiority

Judge 1	Judge 2	Judge 3	Judge 4	Judge 5	Judge 6	Judge 7	Referee

Name _____

Signature _____

Lion Cup 2024 Luxembourg

297 Rue de Reckenthal L-2410 Strassen, LUXEMBOURG

Court Nr.	1	Pool	1	Date	2024-06-08	Field Position	57
RED				BLUE			
NOC	DEFRANCE INS (FRA)			NOC	SIGILL ANASTASIA (SUI)		
Category	06 - Kata Female U14						
3 Points	2 Points	1 Point	Score	1 Point	2 Points	3 Points	
			21 : 21				
Penatlity				Penatlity			
			21.7:2 ..				
			Total	WINNER			

POINTS

Decision of Superiority

Judge 1	Judge 2	Judge 3	Judge 4	Judge 5	Judge 6	Judge 7	Referee

Name _____

Signature _____

Lion Cup 2024 Luxembourg

297 Rue de Reckenthal L-2410 Strassen, LUXEMBOURG

Court Nr.	1	Pool	1	Date	2024-06-08	Field Position	58
RED				BLUE			
NOC	BALDEON AMAZONA (LUX)			NOC	SCHEDEL KAENA (SUI)		
Category	06 - Kata Female U14						
3 Points	2 Points	1 Point	Score	1 Point	2 Points	3 Points	
			20 : 21				
Penatlity					Penatlity		
				20.6:2 ..			
				Total	WINNER		

POINTS

Decision of Superiority

Judge 1	Judge 2	Judge 3	Judge 4	Judge 5	Judge 6	Judge 7	Referee

Name _____

Signature _____

Lion Cup 2024 Luxembourg

297 Rue de Reckenthal L-2410 Strassen, LUXEMBOURG

Court Nr.	1	Pool	1	Date	2024-06-08	Field Position	59
RED				BLUE			
NOC	PAIVA OCEANE (LUX)			NOC	COSTA NURIA (LUX)		
Category	06 - Kata Female U14						
3 Points	2 Points	1 Point	Score	1 Point	2 Points	3 Points	
			19 : 21				
Penatlity				Penatlity			
			19.8:2 ..				
			Total	WINNER			

POINTS

Decision of Superiority

Judge 1	Judge 2	Judge 3	Judge 4	Judge 5	Judge 6	Judge 7	Referee

Name _____

Signature _____

Lion Cup 2024 Luxembourg

297 Rue de Reckenthal L-2410 Strassen, LUXEMBOURG

Court Nr.	1	Pool	1	Date	2024-06-08	Field Position	60
RED				BLUE			
NOC	GOLUBOVIC INIJA (SUI)			NOC	CORNET MAXINE (LUX)		
Category	06 - Kata Female U14						
3 Points	2 Points	1 Point	Score	1 Point	2 Points	3 Points	
			21 : 20				
Penatlity				Penatlity			
			21.5:2 ..				
WINNER			Total				

POINTS

Decision of Superiority

Judge 1	Judge 2	Judge 3	Judge 4	Judge 5	Judge 6	Judge 7	Referee

Name _____

Signature _____

Lion Cup 2024 Luxembourg

297 Rue de Reckenthal L-2410 Strassen, LUXEMBOURG

Court Nr.	1	Pool	1	Date	2024-06-08	Field Position	61
RED				BLUE			
NOC	SIGILL ANASTASIA (SUI)			NOC	SCHEDEL KAENA (SUI)		
Category	06 - Kata Female U14						
3 Points	2 Points	1 Point	Score	1 Point	2 Points	3 Points	
			21 : 21				
Penatlity					Penatlity		
				21.0:2 ..			
				Total	WINNER		

POINTS

Decision of Superiority

Judge 1	Judge 2	Judge 3	Judge 4	Judge 5	Judge 6	Judge 7	Referee

Name _____

Signature _____

Lion Cup 2024 Luxembourg

297 Rue de Reckenthal L-2410 Strassen, LUXEMBOURG

Court Nr.	1	Pool	1	Date	2024-06-08	Field Position	62
RED				BLUE			
NOC	COSTA NURIA (LUX)			NOC	GOLUBOVIC INIJA (SUI)		
Category	06 - Kata Female U14						
3 Points	2 Points	1 Point	Score	1 Point	2 Points	3 Points	
			21 : 20				
Penatlity				Penatlity			
			21.4:2 ..				
WINNER			Total				

POINTS

Decision of Superiority

Judge 1	Judge 2	Judge 3	Judge 4	Judge 5	Judge 6	Judge 7	Referee

Name _____

Signature _____

Lion Cup 2024 Luxembourg

297 Rue de Reckenthal L-2410 Strassen, LUXEMBOURG

Court Nr.	1	Pool	1	Date	2024-06-08	Field Position	63
RED				BLUE			
NOC	SCHEDEL KAENA (SUI)			NOC	COSTA NURIA (LUX)		
Category	06 - Kata Female U14						
3 Points	2 Points	1 Point	Score	1 Point	2 Points	3 Points	
			21 : 21				
Penatlity				Penatlity			
			21.6:2 ..				
WINNER			Total				

POINTS

Decision of Superiority

Judge 1	Judge 2	Judge 3	Judge 4	Judge 5	Judge 6	Judge 7	Referee

Name _____

Signature _____

Lion Cup 2024 Luxembourg

297 Rue de Reckenthal L-2410 Strassen, LUXEMBOURG

Court Nr.	2	Pool	2	Date	2024-06-08	Field Position	49
RED				BLUE			
NOC	GABALLA RAMA (EGY)			NOC	DURRER NAHIMA (LUX)		
Category	06 - Kata Female U14						
3 Points	2 Points	1 Point	Score	1 Point	2 Points	3 Points	
			:				
Penatlity				Penatlity			
			Total				

Decision of Superiority

Judge 1	Judge 2	Judge 3	Judge 4	Judge 5	Judge 6	Judge 7	Referee

Name _____

Signature _____

Lion Cup 2024 Luxembourg

297 Rue de Reckenthal L-2410 Strassen, LUXEMBOURG

Court Nr.	2	Pool	2	Date	2024-06-08	Field Position	53
RED				BLUE			
NOC	YAPOBY CAMERONE (FRA)			NOC	ELS NOMIE (LUX)		
Category	06 - Kata Female U14						
3 Points	2 Points	1 Point	Score	1 Point	2 Points	3 Points	
			:				
Penatlity				Penatlity			
			Total				

Decision of Superiority

Judge 1	Judge 2	Judge 3	Judge 4	Judge 5	Judge 6	Judge 7	Referee

Name _____

Signature _____

Lion Cup 2024 Luxembourg

297 Rue de Reckenthal L-2410 Strassen, LUXEMBOURG

Court Nr.	2	Pool	2	Date	2024-06-08	Field Position	57
RED				BLUE			
NOC	DURRER NAHIMA (LUX)			NOC	GOMES SOLARA (LUX)		
Category	06 - Kata Female U14						
3 Points	2 Points	1 Point	Score	1 Point	2 Points	3 Points	
			:				
Penatlity				Penatlity			
			Total				

Decision of Superiority

Judge 1	Judge 2	Judge 3	Judge 4	Judge 5	Judge 6	Judge 7	Referee

Name _____

Signature _____

Lion Cup 2024 Luxembourg

297 Rue de Reckenthal L-2410 Strassen, LUXEMBOURG

Court Nr.	2	Pool	2	Date	2024-06-08	Field Position	58
RED				BLUE			
NOC	MICHAUD ZO (SUI)			NOC	RIO ILIANA (FRA)		
Category	06 - Kata Female U14						
3 Points	2 Points	1 Point	Score	1 Point	2 Points	3 Points	
			:				
Penatlity				Penatlity			
			Total				

Decision of Superiority

Judge 1	Judge 2	Judge 3	Judge 4	Judge 5	Judge 6	Judge 7	Referee

Name _____

Signature _____

Lion Cup 2024 Luxembourg

297 Rue de Reckenthal L-2410 Strassen, LUXEMBOURG

Court Nr.	2	Pool	2	Date	2024-06-08	Field Position	59
RED				BLUE			
NOC	ELS NOMIE (LUX)			NOC	WEISS TIFFANY (SUI)		
Category	06 - Kata Female U14						
3 Points	2 Points	1 Point	Score	1 Point	2 Points	3 Points	
			:				
Penatlity				Penatlity			
			Total				

Decision of Superiority

Judge 1	Judge 2	Judge 3	Judge 4	Judge 5	Judge 6	Judge 7	Referee

Name _____

Signature _____

Lion Cup 2024 Luxembourg

297 Rue de Reckenthal L-2410 Strassen, LUXEMBOURG

Court Nr.	2	Pool	2	Date	2024-06-08	Field Position	60
RED				BLUE			
NOC	CEDOLIN CLARA (FRA)			NOC	INTINI RAFFAELLI LARA (LUX)		
Category	06 - Kata Female U14						
3 Points	2 Points	1 Point	Score	1 Point	2 Points	3 Points	
			:				
Penatlity				Penatlity			
			Total				

Decision of Superiority

Judge 1	Judge 2	Judge 3	Judge 4	Judge 5	Judge 6	Judge 7	Referee

Name _____

Signature _____

Lion Cup 2024 Luxembourg

297 Rue de Reckenthal L-2410 Strassen, LUXEMBOURG

Court Nr.	2	Pool	2	Date	2024-06-08	Field Position	61
RED				BLUE			
NOC	DURRER NAHIMA (LUX)			NOC	MICHAUD ZO (SUI)		
Category	06 - Kata Female U14						
3 Points	2 Points	1 Point	Score	1 Point	2 Points	3 Points	
			:				
Penatlity				Penatlity			
			Total				

Decision of Superiority

Judge 1	Judge 2	Judge 3	Judge 4	Judge 5	Judge 6	Judge 7	Referee

Name _____

Signature _____

Lion Cup 2024 Luxembourg

297 Rue de Reckenthal L-2410 Strassen, LUXEMBOURG

Court Nr.	2	Pool	2	Date	2024-06-08	Field Position	62
RED				BLUE			
NOC	WEISS TIFFANY (SUI)			NOC	CEDOLIN CLARA (FRA)		
Category	06 - Kata Female U14						
3 Points	2 Points	1 Point	Score	1 Point	2 Points	3 Points	
			:				
Penatlity				Penatlity			
			Total				

Decision of Superiority

Judge 1	Judge 2	Judge 3	Judge 4	Judge 5	Judge 6	Judge 7	Referee

Name _____

Signature _____

Lion Cup 2024 Luxembourg

297 Rue de Reckenthal L-2410 Strassen, LUXEMBOURG

Court Nr.	2	Pool	2	Date	2024-06-08	Field Position	63
RED				BLUE			
NOC	MICHAUD ZO (SUI)			NOC	WEISS TIFFANY (SUI)		
Category	06 - Kata Female U14						
3 Points	2 Points	1 Point	Score	1 Point	2 Points	3 Points	
			:				
Penatlity				Penatlity			
			Total				

Decision of Superiority

Judge 1	Judge 2	Judge 3	Judge 4	Judge 5	Judge 6	Judge 7	Referee

Name _____

Signature _____

Lion Cup 2024 Luxembourg

297 Rue de Reckenthal L-2410 Strassen, LUXEMBOURG

Court Nr.	1	Pool	1	Date	2024-06-08	Field Position	63
RED				BLUE			
NOC	SCHEDEL KAENA (SUI)			NOC	WEISS TIFFANY (SUI)		
Category	06 - Kata Female U14						
3 Points	2 Points	1 Point	Score	1 Point	2 Points	3 Points	
			:				
Penatlity				Penatlity			
			Total				

Decision of Superiority

Judge 1	Judge 2	Judge 3	Judge 4	Judge 5	Judge 6	Judge 7	Referee

Name _____

Signature _____

Lion Cup 2024 Luxembourg

297 Rue de Reckenthal L-2410 Strassen, LUXEMBOURG

Court Nr.	1	Pool	1	Date	2024-06-08	Field Position	0
RED				BLUE			
NOC	SIGILL ANASTASIA (SUI)			NOC	COSTA NURIA (LUX)		
Category	06 - Kata Female U14						
3 Points	2 Points	1 Point	Score	1 Point	2 Points	3 Points	
			21 : 21				
Penatlity				Penatlity			
			21.8:2 ..				
WINNER			Total				

POINTS

Decision of Superiority

Judge 1	Judge 2	Judge 3	Judge 4	Judge 5	Judge 6	Judge 7	Referee

Name _____

Signature _____

Lion Cup 2024 Luxembourg

297 Rue de Reckenthal L-2410 Strassen, LUXEMBOURG

Court Nr.	1	Pool	1	Date	2024-06-08	Field Position	2
RED				BLUE			
NOC	BALDEON AMAZONA (LUX)			NOC	SIGILL ANASTASIA (SUI)		
Category	06 - Kata Female U14						
3 Points	2 Points	1 Point	Score	1 Point	2 Points	3 Points	
			19 : 21				
Penatlity					Penatlity		
				19.9:2 ..			
				Total	WINNER		

POINTS

Decision of Superiority









Judge 1	Judge 2	Judge 3	Judge 4	Judge 5	Judge 6	Judge 7	Referee

Name _____

Signature _____

Lion Cup 2024 Luxembourg - 2024-06-07

Official Results

06 - Kata Female U14			
1	SHEDEL KAENA		SUI - SWITZERLAND
2	WEISS TIFFANY		SUI - SWITZERLAND
3	CEDOLIN CLARA		FRA - FRANCE
3	SIGILLÒ ANASTASIA		SUI - SWITZERLAND
5	MICHAUD ZOË		SUI - SWITZERLAND
5	COSTA NURIA		LUX - LUXEMBOURG
7	ELS NOÉMIE		LUX - LUXEMBOURG
7	BALDEON AMAZONA		LUX - LUXEMBOURG

07 - KATA FEMALE U16

Lion Cup 2024 Luxembourg

ENTRIES BY WEIGHT CATEGORY
07 - Kata Female U16

As of 8 JUN 2024

NOC Code	Gender	Name	Seeding
FRA	F	JUSTINE Kirsten	
FRA	F	NAKANO LEA	
FRA	F	Perie Marx Manon	
FRA	F	Sfih Inès	
FRA	F	VORATOVIC Iliana	
LUX	F	Breisch Anna	
LUX	F	Breiser Anastasia	
LUX	F	Coquillard Elise	
LUX	F	Johanns Camille	
LUX	F	Theisen Margot	
SUI	F	Campell Larissa	
SUI	F	Monnier Cassandra	
SUI	F	Ritz Maia	

07 - Kata Female U16

Lion Cup 2024 Luxembourg, 297 Rue de Reckenthal L-2410 Strassen, LUX

2024-06-07

Tatami
4 20:10

Pool
1/2

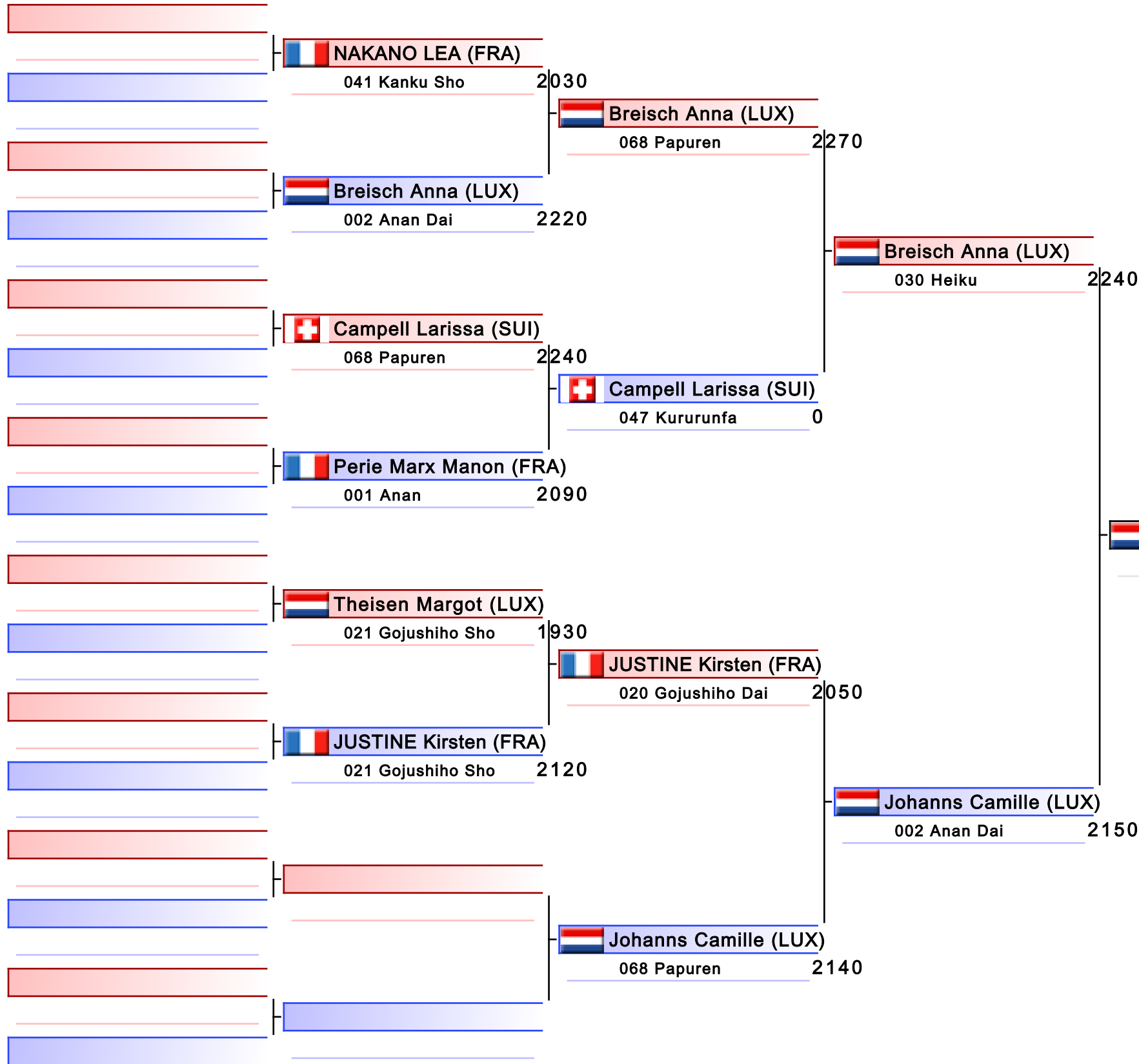

1. VORATOVIC ILIANA (FRA)
2. BREISCH ANNA (LUX)
3. JOHANNS CAMILLE (LUX)
3. SFIHI INÈS (FRA)
5. COQUILLARD ELISE (LUX)
5. CAMPPELL LARISSA (SUI)
7. MONNIER CASSANDRA (SUI)
7. NAKANO LEA (FRA)

07 - Kata Female U16

Lion Cup 2024 Luxembourg, 297 Rue de Reckenthal L-2410 Strassen, LUX

2024-06-07

Tatami
5 19:55

Pool
2/2

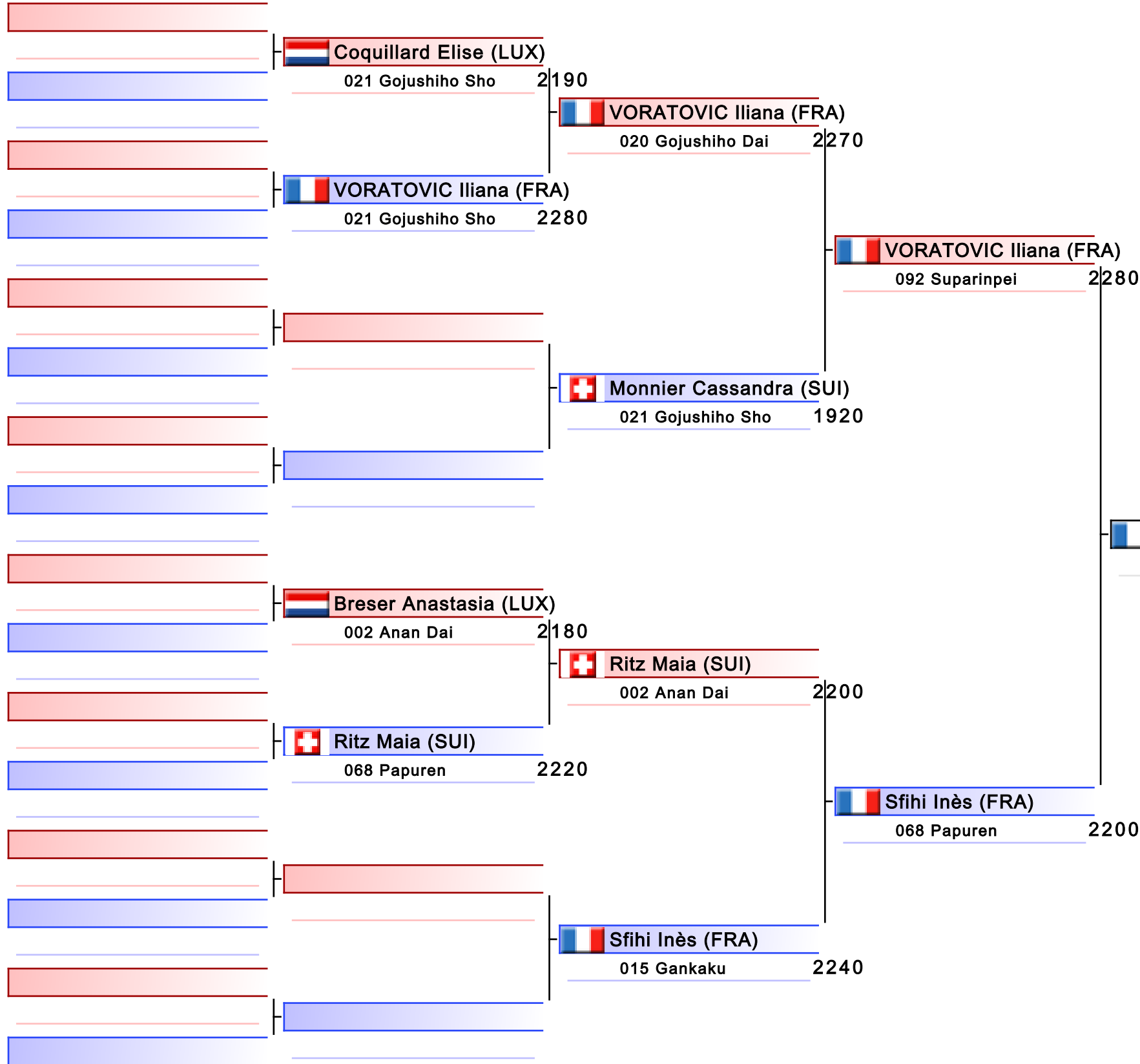

1. VORATOVIC ILIANA (FRA)
2. BREISCH ANNA (LUX)
3. JOHANNNS CAMILLE (LUX)
3. SFIHI INÈS (FRA)
5. COQUILLARD ELISE (LUX)
5. CAMPPELL LARISSA (SUI)
7. MONNIER CASSANDRA (SUI)
7. NAKANO LEA (FRA)

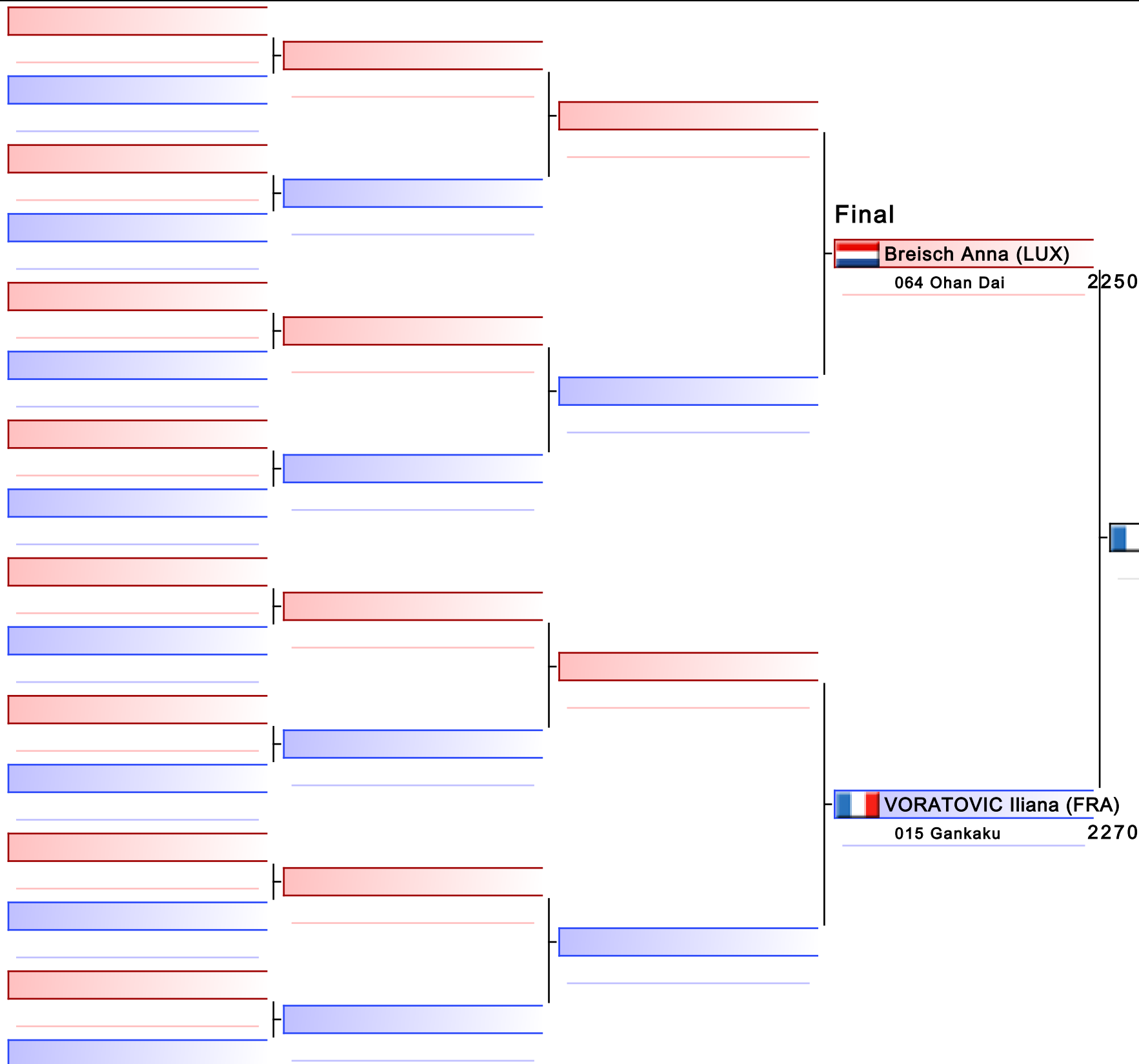

Final

Breisch Anna (LUX)
 064 Ohan Dai 2250

VORATOVIC Iliana (FRA)

VORATOVIC Iliana (FRA)
 015 Gankaku 2270

1. VORATOVIC ILIANA (FRA)
2. BREISCH ANNA (LUX)
3. JOHANNES CAMILLE (LUX)
3. SFIHI INÈS (FRA)
5. COQUILLARD ELISE (LUX)
5. CAMPELL LARISSA (SUI)
7. MONNIER CASSANDRA (SUI)
7. NAKANO LEA (FRA)

07 - Kata Female U16

Lion Cup 2024 Luxembourg

2024-06-07

Tatami
5 20:15

Pool
1

(c)sportdata GmbH & Co KG 2000-2024 (2024-06-08 18:41) v 10.1.0 build 1 (2024-01-24 23:23 CET) License: Online_Event_ID-7672_LionCup2024Luxembourg (expire 2024-06-21)

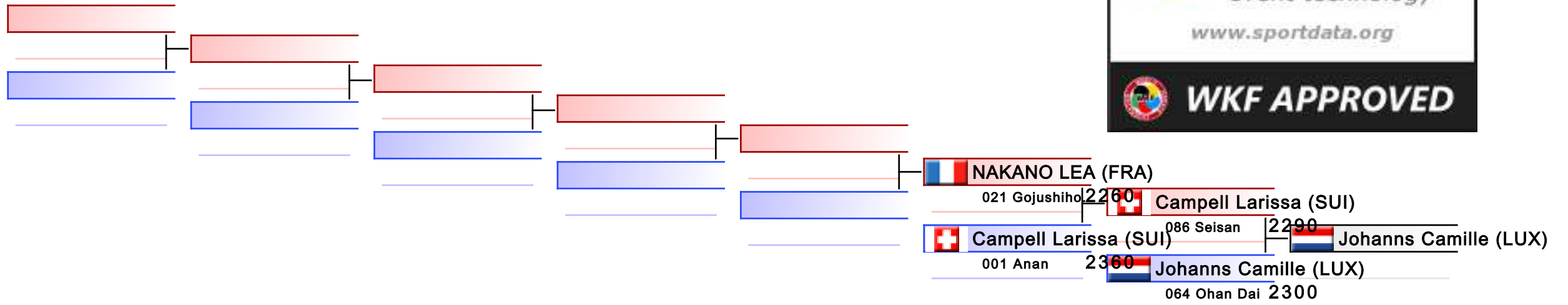

REPECHAGE: (1)

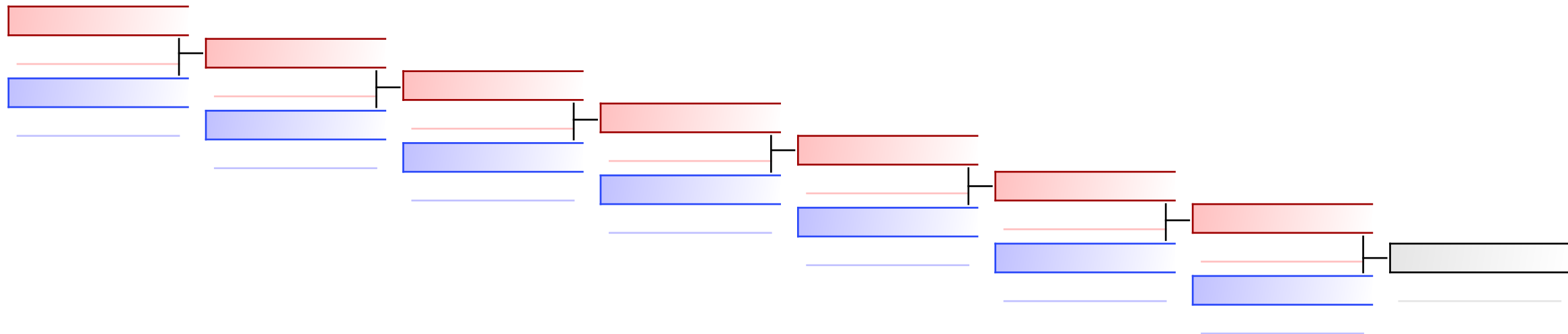

07 - Kata Female U16

Lion Cup 2024 Luxembourg

2024-06-07

Tatami
3 20:20

Pool
2

(c)sportdata GmbH & Co KG 2000-2024 (2024-06-08 18:41) v 10.1.0 build 1 (2024-01-24 23:23 CET) License: Online_Event_ID-7672_LionCup2024Luxembourg (expire 2024-06-21)

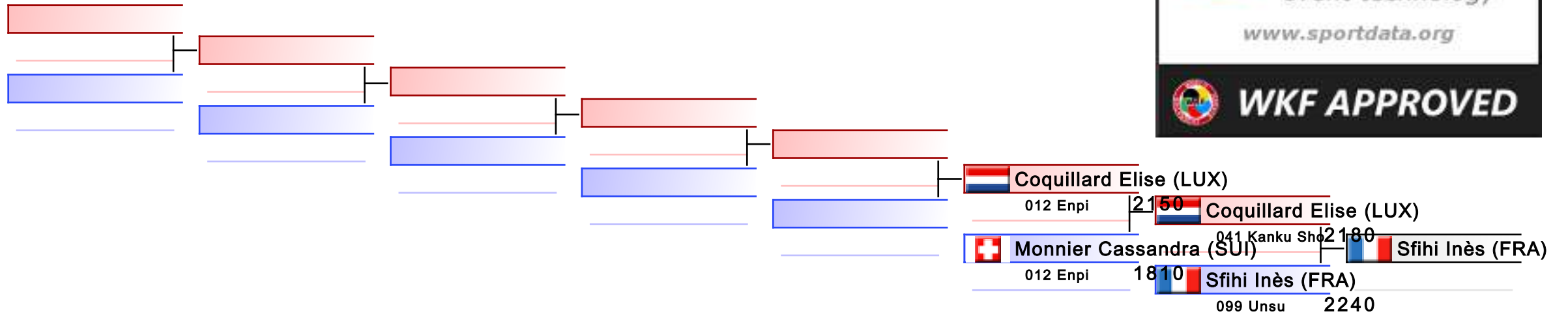

REPECHAGE: (2)

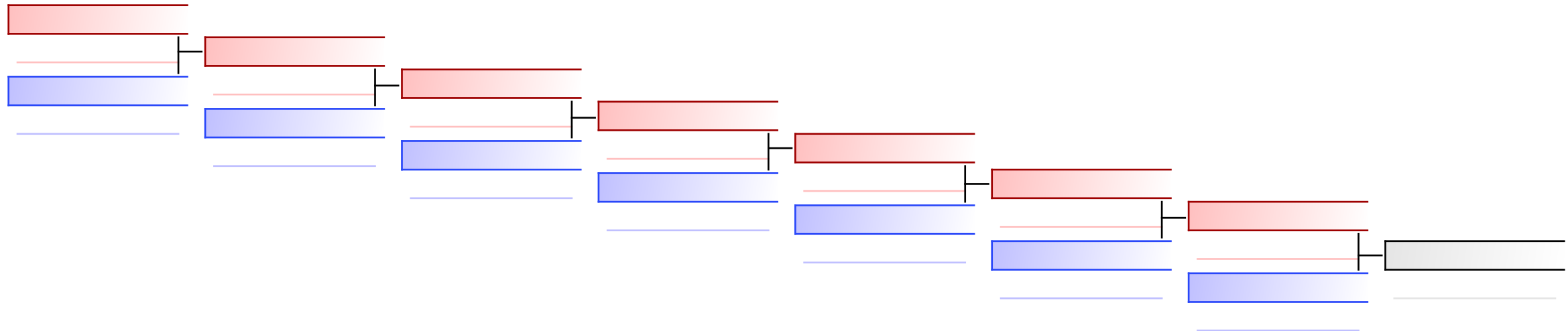

Lion Cup 2024 Luxembourg

297 Rue de Reckenthal L-2410 Strassen, LUXEMBOURG

Court Nr.	1	Pool	1	Date	2024-06-08	Field Position	57
RED				BLUE			
NOC	NAKANO LEA (FRA)			NOC	BREISCH ANNA (LUX)		
Category	07 - Kata Female U16						
3 Points	2 Points	1 Point	Score	1 Point	2 Points	3 Points	
			20 : 22				
Penatlity				Penatlity			
			20.3:2 ..				
			Total	WINNER			

POINTS

Decision of Superiority

Judge 1	Judge 2	Judge 3	Judge 4	Judge 5	Judge 6	Judge 7	Referee

Name _____

Signature _____

Lion Cup 2024 Luxembourg

297 Rue de Reckenthal L-2410 Strassen, LUXEMBOURG

Court Nr.	1	Pool	1	Date	2024-06-08	Field Position	58
RED				BLUE			
NOC	CAMPELL LARISSA (SUI)			NOC	PERIE MARX MANON (FRA)		
Category	07 - Kata Female U16						
3 Points	2 Points	1 Point	Score	1 Point	2 Points	3 Points	
			22 : 20				
Penatlity				Penatlity			
			22.4:2 ..				
WINNER			Total				

POINTS

Decision of Superiority

Judge 1	Judge 2	Judge 3	Judge 4	Judge 5	Judge 6	Judge 7	Referee

Name _____

Signature _____

Lion Cup 2024 Luxembourg

297 Rue de Reckenthal L-2410 Strassen, LUXEMBOURG

Court Nr.	1	Pool	1	Date	2024-06-08	Field Position	59
RED				BLUE			
NOC	THEISEN MARGOT (LUX)			NOC	JUSTINE KIRSTEN (FRA)		
Category	07 - Kata Female U16						
3 Points	2 Points	1 Point	Score	1 Point	2 Points	3 Points	
			19 : 21				
Penatlity				Penatlity			
				19.3:2 ..			
				Total	WINNER		

POINTS

Decision of Superiority

Judge 1	Judge 2	Judge 3	Judge 4	Judge 5	Judge 6	Judge 7	Referee

Name _____

Signature _____

Lion Cup 2024 Luxembourg

297 Rue de Reckenthal L-2410 Strassen, LUXEMBOURG

Court Nr.	1	Pool	1	Date	2024-06-08	Field Position	61
RED				BLUE			
NOC	BREISCH ANNA (LUX)			NOC	CAMPELL LARISSA (SUI)		
Category	07 - Kata Female U16						
3 Points	2 Points	1 Point	Score	1 Point	2 Points	3 Points	
			22 : 21				
Penatlity				Penatlity			
			22.7:2 ..				
WINNER			Total				

POINTS

Decision of Superiority

Judge 1	Judge 2	Judge 3	Judge 4	Judge 5	Judge 6	Judge 7	Referee

Name _____

Signature _____

Lion Cup 2024 Luxembourg

297 Rue de Reckenthal L-2410 Strassen, LUXEMBOURG

Court Nr.	1	Pool	1	Date	2024-06-08	Field Position	62
RED				BLUE			
NOC	JUSTINE KIRSTEN (FRA)			NOC	JOHANNIS CAMILLE (LUX)		
Category	07 - Kata Female U16						
3 Points	2 Points	1 Point	Score	1 Point	2 Points	3 Points	
			20 : 21				
Penatlity				Penatlity			
			20.5:2 ..				
			Total	WINNER			

POINTS

Decision of Superiority

Judge 1	Judge 2	Judge 3	Judge 4	Judge 5	Judge 6	Judge 7	Referee

Name _____

Signature _____

Lion Cup 2024 Luxembourg

297 Rue de Reckenthal L-2410 Strassen, LUXEMBOURG

Court Nr.	1	Pool	1	Date	2024-06-08	Field Position	63
RED				BLUE			
NOC	BREISCH ANNA (LUX)			NOC	JOHANNIS CAMILLE (LUX)		
Category	07 - Kata Female U16						
3 Points	2 Points	1 Point	Score	1 Point	2 Points	3 Points	
			22 : 21				
Penatlity				Penatlity			
			22.4:2 ..				
WINNER			Total				

POINTS

Decision of Superiority

Judge 1	Judge 2	Judge 3	Judge 4	Judge 5	Judge 6	Judge 7	Referee

Name _____

Signature _____

Lion Cup 2024 Luxembourg

297 Rue de Reckenthal L-2410 Strassen, LUXEMBOURG

Court Nr.	2	Pool	2	Date	2024-06-08	Field Position	57
RED				BLUE			
NOC	COQUILLARD ELISE (LUX)			NOC	VORATOVIC ILIANA (FRA)		
Category	07 - Kata Female U16						
3 Points	2 Points	1 Point	Score	1 Point	2 Points	3 Points	
			:				
Penatlity				Penatlity			
			Total				

Decision of Superiority

Judge 1	Judge 2	Judge 3	Judge 4	Judge 5	Judge 6	Judge 7	Referee

Name _____

Signature _____

Lion Cup 2024 Luxembourg

297 Rue de Reckenthal L-2410 Strassen, LUXEMBOURG

Court Nr.	2	Pool	2	Date	2024-06-08	Field Position	59
RED				BLUE			
NOC	BRESER ANASTASIA (LUX)			NOC	RITZ MAIA (SUI)		
Category	07 - Kata Female U16						
3 Points	2 Points	1 Point	Score	1 Point	2 Points	3 Points	
			:				
Penatlity				Penatlity			
			Total				

Decision of Superiority

Judge 1	Judge 2	Judge 3	Judge 4	Judge 5	Judge 6	Judge 7	Referee

Name _____

Signature _____

Lion Cup 2024 Luxembourg

297 Rue de Reckenthal L-2410 Strassen, LUXEMBOURG

Court Nr.	2	Pool	2	Date	2024-06-08	Field Position	61
RED				BLUE			
NOC	VORATOVIC ILIANA (FRA)			NOC	MONNIER CASSANDRA (SUI)		
Category	07 - Kata Female U16						
3 Points	2 Points	1 Point	Score	1 Point	2 Points	3 Points	
			:				
Penatlity				Penatlity			
			Total				

Decision of Superiority

Judge 1	Judge 2	Judge 3	Judge 4	Judge 5	Judge 6	Judge 7	Referee

Name _____

Signature _____

Lion Cup 2024 Luxembourg

297 Rue de Reckenthal L-2410 Strassen, LUXEMBOURG

Court Nr.	2	Pool	2	Date	2024-06-08	Field Position	62
RED				BLUE			
NOC	RITZ MAIA (SUI)			NOC	SFIHI INS (FRA)		
Category	07 - Kata Female U16						
3 Points	2 Points	1 Point	Score	1 Point	2 Points	3 Points	
			:				
Penatlity				Penatlity			
			Total				

Decision of Superiority

Judge 1	Judge 2	Judge 3	Judge 4	Judge 5	Judge 6	Judge 7	Referee

Name _____

Signature _____

Lion Cup 2024 Luxembourg

297 Rue de Reckenthal L-2410 Strassen, LUXEMBOURG

Court Nr.	2	Pool	2	Date	2024-06-08	Field Position	63
RED				BLUE			
NOC	VORATOVIC ILIANA (FRA)			NOC	SFIHI INS (FRA)		
Category	07 - Kata Female U16						
3 Points	2 Points	1 Point	Score	1 Point	2 Points	3 Points	
			:				
Penatlity				Penatlity			
			Total				

Decision of Superiority

Judge 1	Judge 2	Judge 3	Judge 4	Judge 5	Judge 6	Judge 7	Referee

Name _____

Signature _____

Lion Cup 2024 Luxembourg

297 Rue de Reckenthal L-2410 Strassen, LUXEMBOURG

Court Nr.	1	Pool	1	Date	2024-06-08	Field Position	63
RED				BLUE			
NOC	BREISCH ANNA (LUX)			NOC	VORATOVIC ILIANA (FRA)		
Category	07 - Kata Female U16						
3 Points	2 Points	1 Point	Score	1 Point	2 Points	3 Points	
			22 : 22				
Penatlity				Penatlity			
			22.5:2 ..				
			Total	WINNER			

POINTS

Decision of Superiority

Judge 1	Judge 2	Judge 3	Judge 4	Judge 5	Judge 6	Judge 7	Referee

Name _____

Signature _____

Lion Cup 2024 Luxembourg

297 Rue de Reckenthal L-2410 Strassen, LUXEMBOURG

Court Nr.	1	Pool	1	Date	2024-06-08	Field Position	0
RED				BLUE			
NOC	CAMPELL LARISSA (SUI)			NOC	JOHANNIS CAMILLE (LUX)		
Category	07 - Kata Female U16						
3 Points	2 Points	1 Point	Score	1 Point	2 Points	3 Points	
			22 : 23				
Penatlity				Penatlity			
			22.9:2 ..				
			Total	WINNER			

POINTS

Decision of Superiority

Judge 1	Judge 2	Judge 3	Judge 4	Judge 5	Judge 6	Judge 7	Referee

Name _____

Signature _____

Lion Cup 2024 Luxembourg

297 Rue de Reckenthal L-2410 Strassen, LUXEMBOURG

Court Nr.	1	Pool	1	Date	2024-06-08	Field Position	2
RED				BLUE			
NOC	NAKANO LEA (FRA)			NOC	CAMPELL LARISSA (SUI)		
Category	07 - Kata Female U16						
3 Points	2 Points	1 Point	Score	1 Point	2 Points	3 Points	
			22 : 23				
Penatlity				Penatlity			
			22.6:2 ..				
			Total	WINNER			

POINTS

Decision of Superiority

Judge 1	Judge 2	Judge 3	Judge 4	Judge 5	Judge 6	Judge 7	Referee

Name _____

Signature _____

Lion Cup 2024 Luxembourg - 2024-06-07

Official Results

07 - Kata Female U16			
1	VORATOVIC ILIANA		FRA - FRANCE
2	BREISCH ANNA		LUX - LUXEMBOURG
3	JOHANNES CAMILLE		LUX - LUXEMBOURG
3	SFIHI INÈS		FRA - FRANCE
5	COQUILLARD ELISE		LUX - LUXEMBOURG
5	CAMPELL LARISSA		SUI - SWITZERLAND
7	MONNIER CASSANDRA		SUI - SWITZERLAND
7	NAKANO LEA		FRA - FRANCE

08 - KATA FEMALE U18

Lion Cup 2024 Luxembourg

ENTRIES BY WEIGHT CATEGORY
08 - Kata Female U18

As of 8 JUN 2024

NOC Code	Gender	Name	Seeding
BEL	F	Henroteaux Lou	
BEL	F	LENARTZ Maeva	
BEL	F	Manca Giulia	
BEL	F	MILER Gelsey	
FRA	F	BAUDARD LAURE	
FRA	F	DRUJON Maelle	
FRA	F	GUILLAUME Cassandre	
FRA	F	VORATOVIC Iliana	
LUX	F	Reding Mia	
LUX	F	Rodrigo Sarah	
LUX	F	Rossy Mauricio Iana	
LUX	F	Theisen Monique	
SUI	F	Delay Sara	
SUI	F	Eiselt Zoe	
SUI	F	Fortunato Emma	
SUI	F	Gallimore Kim	
SUI	F	Pelladoni Gina	
SUI	F	Ritz Lila	
WAL	F	Lewis Chloe	

08 - Kata Female U18

Lion Cup 2024 Luxembourg, 297 Rue de Reckenthal L-2410 Strassen, LUX

2024-06-07

Tatami
1 17:30

Pool
1/1

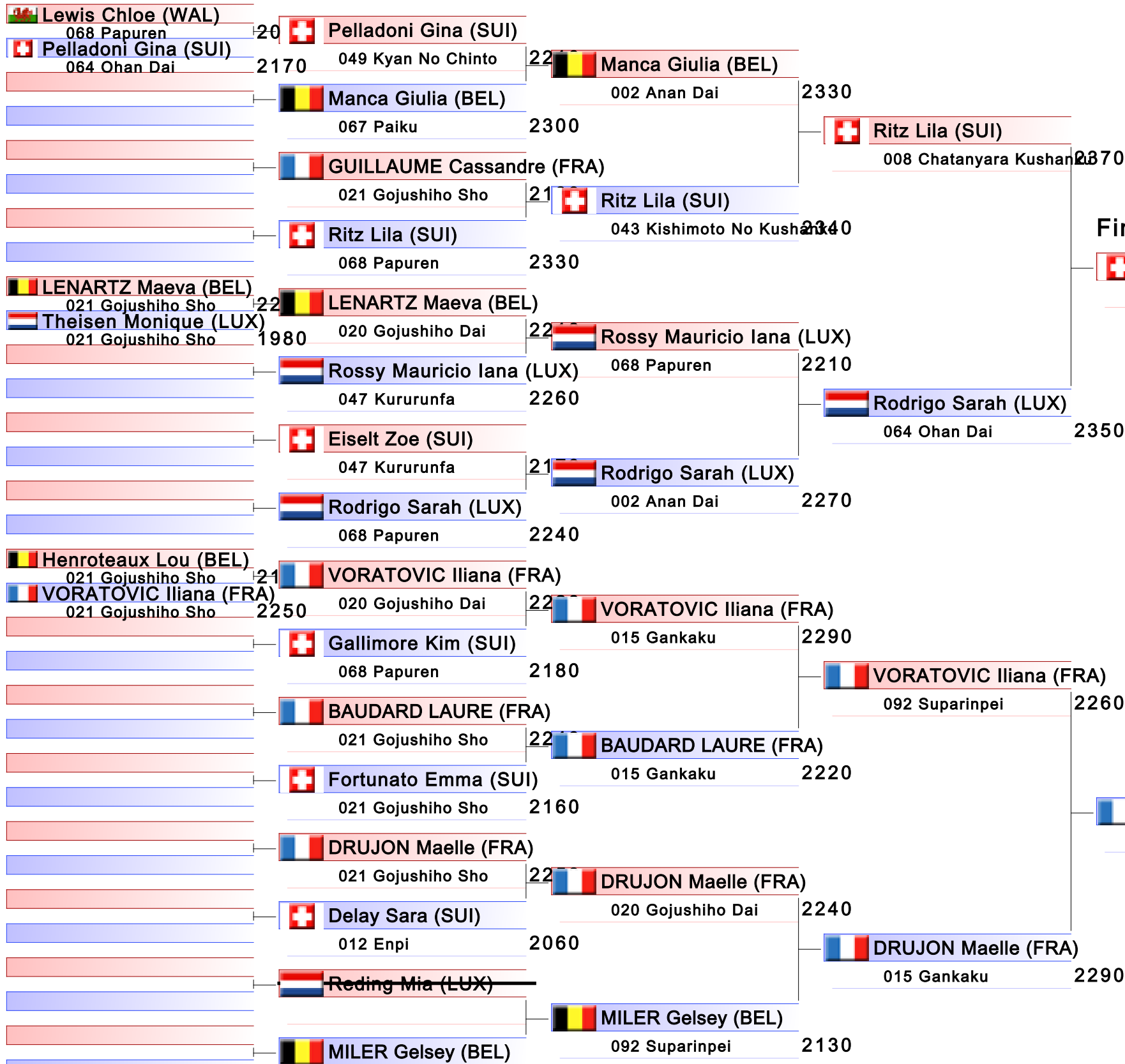

1. RITZ LILA (SUI)
2. DRUJON MAELLE (FRA)
3. MANCA GIULIA (BEL)
3. VORATOVIC ILIANA (FRA)
5. RODRIGO SARA (LUX)
5. MILER GELSEY (BEL)
7. GUILLAUME CASSANDRE (FRA)
7. DELAY SARA (SUI)

08 - Kata Female U18

Lion Cup 2024 Luxembourg

2024-06-07

Tatami
1 18:50

Pool
1

(c)sportdata GmbH & Co KG 2000-2024 (2024-06-08 18:41) v 10.1.0 build 1 (2024-01-24 23:23 CET) License: Online_Event_ID-7672_LionCup2024Luxembourg (expire 2024-06-21)

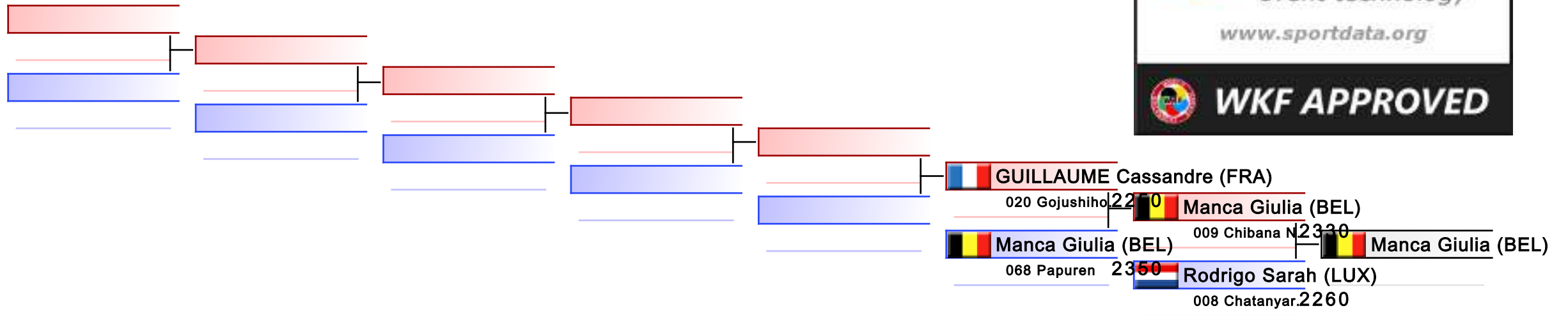

REPECHAGE: (1)

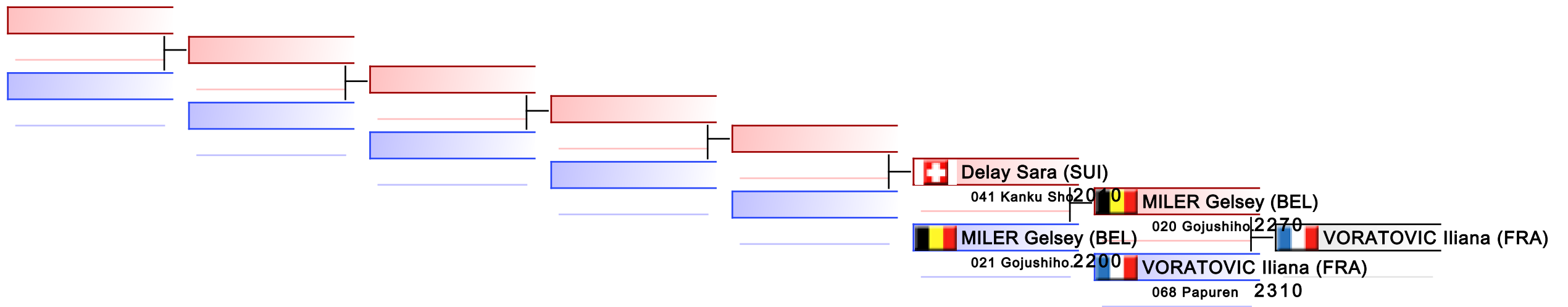

Lion Cup 2024 Luxembourg

297 Rue de Reckenthal L-2410 Strassen, LUXEMBOURG

Court Nr.	1	Pool	1	Date	2024-06-08	Field Position	33
RED				BLUE			
NOC	LEWIS CHLOE (WAL)			NOC	PELLADONI GINA (SUI)		
Category	08 - Kata Female U18						
3 Points	2 Points	1 Point	Score	1 Point	2 Points	3 Points	
			20 : 21				
Penatlity				Penatlity			
			20.3:2 ..				
			Total	WINNER			

POINTS

Decision of Superiority

Judge 1	Judge 2	Judge 3	Judge 4	Judge 5	Judge 6	Judge 7	Referee

Name _____

Signature _____

Lion Cup 2024 Luxembourg

297 Rue de Reckenthal L-2410 Strassen, LUXEMBOURG

Court Nr.	1	Pool	1	Date	2024-06-08	Field Position	37
RED				BLUE			
NOC	LENARTZ MAEVA (BEL)			NOC	THEISEN MONIQUE (LUX)		
Category	08 - Kata Female U18						
3 Points	2 Points	1 Point	Score	1 Point	2 Points	3 Points	
			22 : 19				
Penatlity				Penatlity			
			22.2:1 ..				
WINNER			Total				

POINTS

Decision of Superiority

Judge 1	Judge 2	Judge 3	Judge 4	Judge 5	Judge 6	Judge 7	Referee

Name _____

Signature _____

Lion Cup 2024 Luxembourg

297 Rue de Reckenthal L-2410 Strassen, LUXEMBOURG

Court Nr.	1	Pool	1	Date	2024-06-08	Field Position	41
RED				BLUE			
NOC	HENROTEAUX LOU (BEL)			NOC	VORATOVIC ILIANA (FRA)		
Category	08 - Kata Female U18						
3 Points	2 Points	1 Point	Score	1 Point	2 Points	3 Points	
			21 : 22				
Penatlity					Penatlity		
				21.8:2 ..			
				Total	WINNER		

POINTS

Decision of Superiority

Judge 1	Judge 2	Judge 3	Judge 4	Judge 5	Judge 6	Judge 7	Referee

Name _____

Signature _____

Lion Cup 2024 Luxembourg

297 Rue de Reckenthal L-2410 Strassen, LUXEMBOURG

Court Nr.	1	Pool	1	Date	2024-06-08	Field Position	49
RED				BLUE			
NOC	PELLADONI GINA (SUI)			NOC	MANCA GIULIA (BEL)		
Category	08 - Kata Female U18						
3 Points	2 Points	1 Point	Score	1 Point	2 Points	3 Points	
			22 : 23				
Penatlity				Penatlity			
			22.1:2 ..				
			Total	WINNER			

POINTS

Decision of Superiority

Judge 1	Judge 2	Judge 3	Judge 4	Judge 5	Judge 6	Judge 7	Referee

Name _____

Signature _____

Lion Cup 2024 Luxembourg

297 Rue de Reckenthal L-2410 Strassen, LUXEMBOURG

Court Nr.	1	Pool	1	Date	2024-06-08	Field Position	50
RED				BLUE			
NOC	GUILLAUME CASSANDRE (FRA)			NOC	RITZ LILA (SUI)		
Category	08 - Kata Female U18						
3 Points	2 Points	1 Point	Score	1 Point	2 Points	3 Points	
			21 : 23				
Penatlity				Penatlity			
			21.8:2 ..				
			Total	WINNER			

POINTS

Decision of Superiority

Judge 1	Judge 2	Judge 3	Judge 4	Judge 5	Judge 6	Judge 7	Referee

Name _____

Signature _____

Lion Cup 2024 Luxembourg

297 Rue de Reckenthal L-2410 Strassen, LUXEMBOURG

Court Nr.	1	Pool	1	Date	2024-06-08	Field Position	51
RED				BLUE			
NOC	LENARTZ MAEVA (BEL)			NOC	ROSSY MAURICIO IANA (LUX)		
Category	08 - Kata Female U18						
3 Points	2 Points	1 Point	Score	1 Point	2 Points	3 Points	
			22 : 22				
Penatlity				Penatlity			
			22.1:2 ..				
			Total	WINNER			

POINTS

Decision of Superiority

Judge 1	Judge 2	Judge 3	Judge 4	Judge 5	Judge 6	Judge 7	Referee

Name _____

Signature _____

Lion Cup 2024 Luxembourg

297 Rue de Reckenthal L-2410 Strassen, LUXEMBOURG

Court Nr.	1	Pool	1	Date	2024-06-08	Field Position	52
RED				BLUE			
NOC	EISELT ZOE (SUI)			NOC	RODRIGO SARAH (LUX)		
Category	08 - Kata Female U18						
3 Points	2 Points	1 Point	Score	1 Point	2 Points	3 Points	
			21 : 22				
Penatlity				Penatlity			
			21.7:2 ..				
			Total	WINNER			

POINTS

Decision of Superiority

Judge 1	Judge 2	Judge 3	Judge 4	Judge 5	Judge 6	Judge 7	Referee

Name _____

Signature _____

Lion Cup 2024 Luxembourg

297 Rue de Reckenthal L-2410 Strassen, LUXEMBOURG

Court Nr.	1	Pool	1	Date	2024-06-08	Field Position	53
RED				BLUE			
NOC	VORATOVIC ILIANA (FRA)			NOC	GALLIMORE KIM (SUI)		
Category	08 - Kata Female U18						
3 Points	2 Points	1 Point	Score	1 Point	2 Points	3 Points	
			22 : 21				
Penatlity					Penatlity		
				22.2:2 ..			
WINNER				Total			

POINTS

Decision of Superiority

Judge 1	Judge 2	Judge 3	Judge 4	Judge 5	Judge 6	Judge 7	Referee

Name _____

Signature _____

Lion Cup 2024 Luxembourg

297 Rue de Reckenthal L-2410 Strassen, LUXEMBOURG

Court Nr.	1	Pool	1	Date	2024-06-08	Field Position	54
RED				BLUE			
NOC	BAUDARD LAURE (FRA)			NOC	FORTUNATO EMMA (SUI)		
Category	08 - Kata Female U18						
3 Points	2 Points	1 Point	Score	1 Point	2 Points	3 Points	
			22 : 21				
Penatlity				Penatlity			
			22.4:2 ..				
WINNER			Total				

POINTS

Decision of Superiority

Judge 1	Judge 2	Judge 3	Judge 4	Judge 5	Judge 6	Judge 7	Referee

Name _____

Signature _____

Lion Cup 2024 Luxembourg

297 Rue de Reckenthal L-2410 Strassen, LUXEMBOURG

Court Nr.	1	Pool	1	Date	2024-06-08	Field Position	55
RED				BLUE			
NOC	DRUJON MAELLE (FRA)			NOC	DELAY SARA (SUI)		
Category	08 - Kata Female U18						
3 Points	2 Points	1 Point	Score	1 Point	2 Points	3 Points	
			22 : 20				
Penatlity				Penatlity			
			22.5:2 ..				
WINNER			Total				

POINTS

Decision of Superiority

Judge 1	Judge 2	Judge 3	Judge 4	Judge 5	Judge 6	Judge 7	Referee

Name _____

Signature _____

Lion Cup 2024 Luxembourg

297 Rue de Reckenthal L-2410 Strassen, LUXEMBOURG

Court Nr.	1	Pool	1	Date	2024-06-08	Field Position	57
RED				BLUE			
NOC	MANCA GIULIA (BEL)			NOC	RITZ LILA (SUI)		
Category	08 - Kata Female U18						
3 Points	2 Points	1 Point	Score	1 Point	2 Points	3 Points	
			23 : 23				
Penatlity				Penatlity			
			23.3:2 ..				
			Total	WINNER			

POINTS

Decision of Superiority

Judge 1	Judge 2	Judge 3	Judge 4	Judge 5	Judge 6	Judge 7	Referee

Name _____

Signature _____

Lion Cup 2024 Luxembourg

297 Rue de Reckenthal L-2410 Strassen, LUXEMBOURG

Court Nr.	1	Pool	1	Date	2024-06-08	Field Position	58
RED				BLUE			
NOC	ROSSY MAURICIO IANA (LUX)			NOC	RODRIGO SARAH (LUX)		
Category	08 - Kata Female U18						
3 Points	2 Points	1 Point	Score	1 Point	2 Points	3 Points	
			22 : 22				
Penatlity				Penatlity			
			22.1:2 ..				
			Total	WINNER			

POINTS

Decision of Superiority

Judge 1	Judge 2	Judge 3	Judge 4	Judge 5	Judge 6	Judge 7	Referee

Name _____

Signature _____

Lion Cup 2024 Luxembourg

297 Rue de Reckenthal L-2410 Strassen, LUXEMBOURG

Court Nr.	1	Pool	1	Date	2024-06-08	Field Position	59
RED				BLUE			
NOC	VORATOVIC ILIANA (FRA)			NOC	BAUDARD LAURE (FRA)		
Category	08 - Kata Female U18						
3 Points	2 Points	1 Point	Score	1 Point	2 Points	3 Points	
			22 : 22				
Penatlity				Penatlity			
			22.9:2 ..				
WINNER			Total				

POINTS

Decision of Superiority

Judge 1	Judge 2	Judge 3	Judge 4	Judge 5	Judge 6	Judge 7	Referee

Name _____

Signature _____

Lion Cup 2024 Luxembourg

297 Rue de Reckenthal L-2410 Strassen, LUXEMBOURG

Court Nr.	1	Pool	1	Date	2024-06-08	Field Position	60
RED				BLUE			
NOC	DRUJON MAELLE (FRA)			NOC	MILER GELSEY (BEL)		
Category	08 - Kata Female U18						
3 Points	2 Points	1 Point	Score	1 Point	2 Points	3 Points	
			22 : 21				
Penatlity				Penatlity			
			22.4:2 ..				
WINNER			Total				

POINTS

Decision of Superiority

Judge 1	Judge 2	Judge 3	Judge 4	Judge 5	Judge 6	Judge 7	Referee

Name _____

Signature _____

Lion Cup 2024 Luxembourg

297 Rue de Reckenthal L-2410 Strassen, LUXEMBOURG

Court Nr.	1	Pool	1	Date	2024-06-08	Field Position	61
RED				BLUE			
NOC	RITZ LILA (SUI)			NOC	RODRIGO SARAH (LUX)		
Category	08 - Kata Female U18						
3 Points	2 Points	1 Point	Score	1 Point	2 Points	3 Points	
			23 : 23				
Penatlity				Penatlity			
			23.7:2 ..				
WINNER			Total				

POINTS

Decision of Superiority

Judge 1	Judge 2	Judge 3	Judge 4	Judge 5	Judge 6	Judge 7	Referee

Name _____

Signature _____

Lion Cup 2024 Luxembourg

297 Rue de Reckenthal L-2410 Strassen, LUXEMBOURG

Court Nr.	1	Pool	1	Date	2024-06-08	Field Position	62
RED				BLUE			
NOC	VORATOVIC ILIANA (FRA)			NOC	DRUJON MAELLE (FRA)		
Category	08 - Kata Female U18						
3 Points	2 Points	1 Point	Score	1 Point	2 Points	3 Points	
			22 : 22				
Penatlity					Penatlity		
				22.6:2 ..			
				Total	WINNER		

POINTS

Decision of Superiority

Judge 1	Judge 2	Judge 3	Judge 4	Judge 5	Judge 6	Judge 7	Referee

Name _____

Signature _____

Lion Cup 2024 Luxembourg

297 Rue de Reckenthal L-2410 Strassen, LUXEMBOURG

Court Nr.	1	Pool	1	Date	2024-06-08	Field Position	63
RED				BLUE			
NOC	RITZ LILA (SUI)			NOC	DRUJON MAELLE (FRA)		
Category	08 - Kata Female U18						
3 Points	2 Points	1 Point	Score	1 Point	2 Points	3 Points	
			24 : 23				
Penatlity				Penatlity			
			24.5:2 ..				
WINNER			Total				

POINTS

Decision of Superiority

Judge 1	Judge 2	Judge 3	Judge 4	Judge 5	Judge 6	Judge 7	Referee

Name _____

Signature _____

Lion Cup 2024 Luxembourg

297 Rue de Reckenthal L-2410 Strassen, LUXEMBOURG

Court Nr.	1	Pool	1	Date	2024-06-08	Field Position	0
RED				BLUE			
NOC	MANCA GIULIA (BEL)			NOC	RODRIGO SARAH (LUX)		
Category	08 - Kata Female U18						
3 Points	2 Points	1 Point	Score	1 Point	2 Points	3 Points	
			23 : 22				
Penatlity				Penatlity			
			23.3:2 ..				
WINNER			Total				

POINTS

Decision of Superiority

Judge 1	Judge 2	Judge 3	Judge 4	Judge 5	Judge 6	Judge 7	Referee

Name _____

Signature _____

Lion Cup 2024 Luxembourg

297 Rue de Reckenthal L-2410 Strassen, LUXEMBOURG

Court Nr.	1	Pool	1	Date	2024-06-08	Field Position	2
RED				BLUE			
NOC	GUILLAUME CASSANDRE (FRA)			NOC	MANCA GIULIA (BEL)		
Category	08 - Kata Female U18						
3 Points	2 Points	1 Point	Score	1 Point	2 Points	3 Points	
			22 : 23				
Penatlity				Penatlity			
			22.5:2 ..				
			Total	WINNER			

POINTS

Decision of Superiority

Judge 1	Judge 2	Judge 3	Judge 4	Judge 5	Judge 6	Judge 7	Referee

Name _____

Signature _____

Lion Cup 2024 Luxembourg

297 Rue de Reckenthal L-2410 Strassen, LUXEMBOURG

Court Nr.	2	Pool	2	Date	2024-06-08	Field Position	0
RED				BLUE			
NOC	MILER GELSEY (BEL)			NOC	VORATOVIC ILIANA (FRA)		
Category	08 - Kata Female U18						
3 Points	2 Points	1 Point	Score	1 Point	2 Points	3 Points	
			22 : 23				
Penatlity				Penatlity			
			22.7:2 ..				
			Total	WINNER			

POINTS

Decision of Superiority

Judge 1	Judge 2	Judge 3	Judge 4	Judge 5	Judge 6	Judge 7	Referee

Name _____

Signature _____

Lion Cup 2024 Luxembourg

297 Rue de Reckenthal L-2410 Strassen, LUXEMBOURG

Court Nr.	2	Pool	2	Date	2024-06-08	Field Position	2
RED				BLUE			
NOC	DELAY SARA (SUI)			NOC	MILER GELSEY (BEL)		
Category	08 - Kata Female U18						
3 Points	2 Points	1 Point	Score	1 Point	2 Points	3 Points	
			20 : 22				
Penatlity				Penatlity			
			20.1:2 ..				
			Total	WINNER			

POINTS

Decision of Superiority

Judge 1	Judge 2	Judge 3	Judge 4	Judge 5	Judge 6	Judge 7	Referee

Name _____

Signature _____

Official Results

08 - Kata Female U18			
1	RITZ LILA		SUI - SWITZERLAND
2	DRUJON MAELLE		FRA - FRANCE
3	MANCA GIULIA		BEL - BELGIUM
3	VORATOVIC ILIANA		FRA - FRANCE
5	RODRIGO SARAH		LUX - LUXEMBOURG
5	MILER GELSEY		BEL - BELGIUM
7	GUILLAUME CASSANDRE		FRA - FRANCE
7	DELAY SARA		SUI - SWITZERLAND

09 - KATA FEMALE U21

Lion Cup 2024 Luxembourg

ENTRIES BY WEIGHT CATEGORY
09 - Kata Female U21

As of 8 JUN 2024

NOC Code	Gender	Name	Seeding
BEL	F	Scuflaire Emma	
FRA	F	Ancel Chloe	
FRA	F	DRUJON Lucille	
FRA	F	LEITAO Romane	
NED	F	Steenhuijsen Eva	
NED	F	Wu Lisa	
SUI	F	Tschanz Olivia	
SUI	F	Zayed Fatima	

09 - Kata Female U21

Lion Cup 2024 Luxembourg, 297 Rue de Reckenthal L-2410 Strassen, LUX

2024-06-07

Tatami
4 18:30

Pool
1 / 1

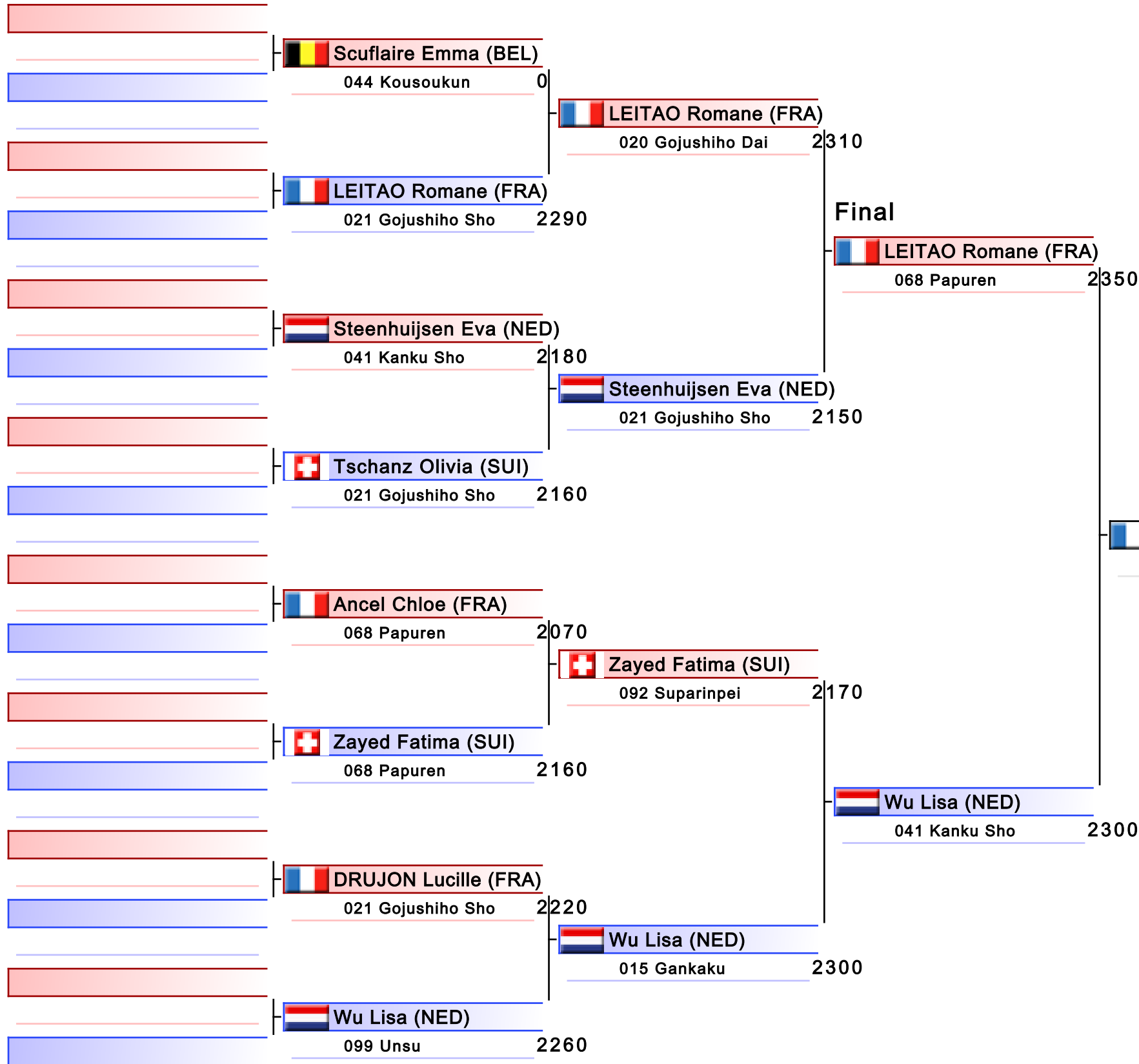

1. LEITAO ROMANE (FRA)
2. WU LISA (NED)
3. STEENHUIJSEN EVA (NED)
3. DRUJON LUCILLE (FRA)
5. SCUFLAIRE EMMA (BEL)
5. ZAYED FATIMA (SUI)

09 - Kata Female U21

Lion Cup 2024 Luxembourg

2024-06-07



Tatami
4 19:00

Pool
1

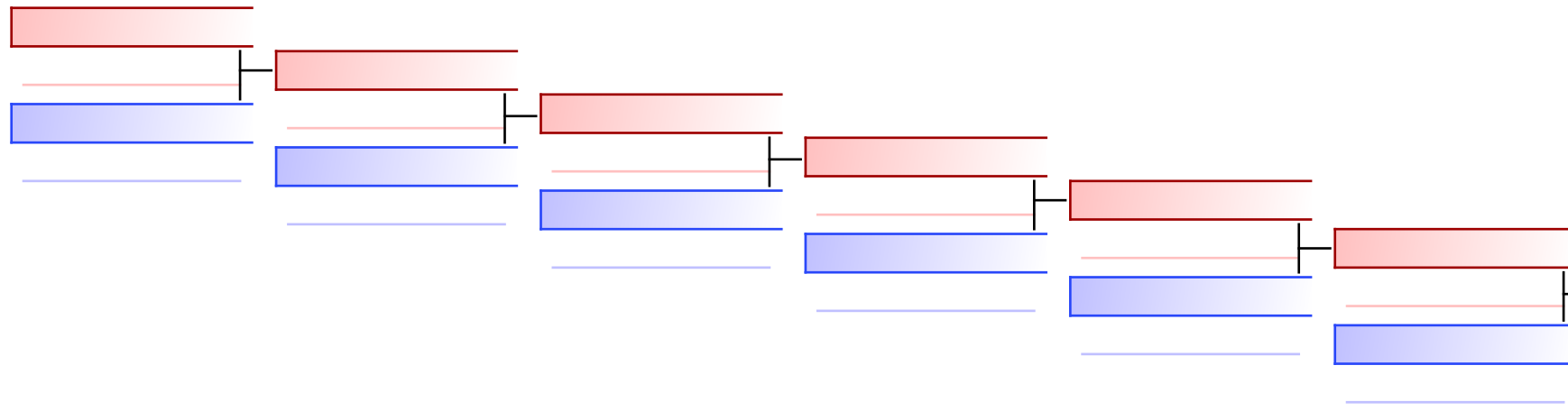
(c)sportdata GmbH & Co KG 2000-2024 (2024-06-08 18:41) v 10.1.0 build 1 (2024-01-24 23:23 CET) License: Online_Event_ID-7672_LionCup2024Luxembourg (expire 2024-06-21)





 **Scufaire Emma (BEL)**
019 Gojushindō 2020

 **Steenhuijsen Eva (NED)**
 **Steenhuijsen Eva (NED)**
015 Gankaku 2160

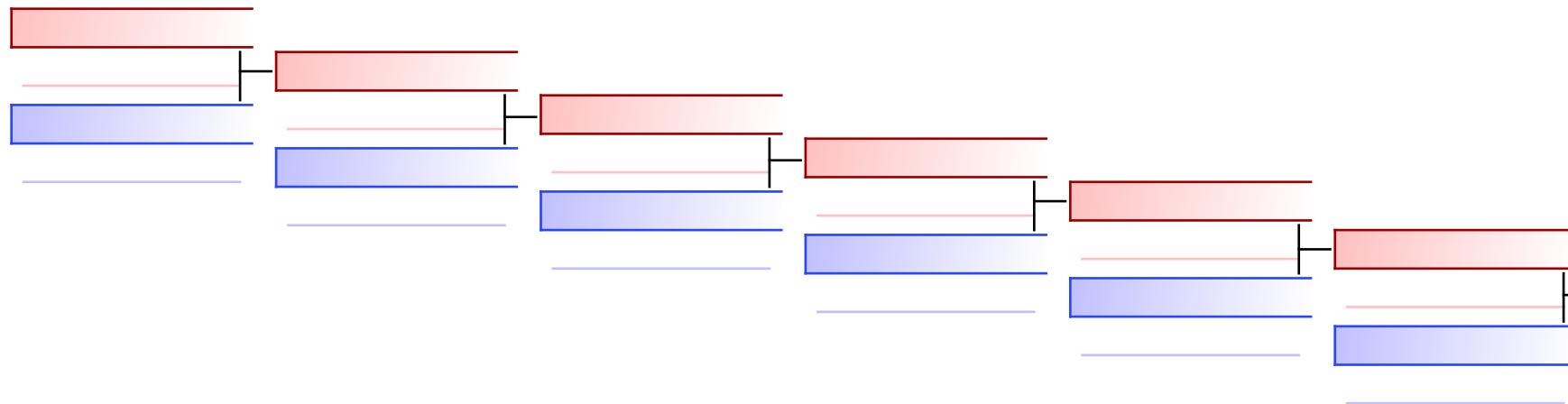
REPECHAGE: (1)



 **DRUJON Lucille (FRA)**
015 Gankaku 2230

 **DRUJON Lucille (FRA)**

 **Zayed Fatima (SUI)**
067 Paiku 2110

Lion Cup 2024 Luxembourg

297 Rue de Reckenthal L-2410 Strassen, LUXEMBOURG

Court Nr.	1	Pool	1	Date	2024-06-08	Field Position	57
RED				BLUE			
NOC	SCUFLAIRE EMMA (BEL)			NOC	LEITAO ROMANE (FRA)		
Category	09 - Kata Female U21						
3 Points	2 Points	1 Point	Score	1 Point	2 Points	3 Points	
			0 : 22				
Penatlity				Penatlity			
			Total				

Decision of Superiority

Judge 1	Judge 2	Judge 3	Judge 4	Judge 5	Judge 6	Judge 7	Referee

Name _____

Signature _____

Lion Cup 2024 Luxembourg

297 Rue de Reckenthal L-2410 Strassen, LUXEMBOURG

Court Nr.	1	Pool	1	Date	2024-06-08	Field Position	58
RED				BLUE			
NOC	STEENHUIJSEN EVA (NED)			NOC	TSCHANZ OLIVIA (SUI)		
Category	09 - Kata Female U21						
3 Points	2 Points	1 Point	Score	1 Point	2 Points	3 Points	
			21 : 21				
Penatlity					Penatlity		
				21.8:2 ..			
WINNER				Total			

POINTS

Decision of Superiority

Judge 1	Judge 2	Judge 3	Judge 4	Judge 5	Judge 6	Judge 7	Referee

Name _____

Signature _____

Lion Cup 2024 Luxembourg

297 Rue de Reckenthal L-2410 Strassen, LUXEMBOURG

Court Nr.	1	Pool	1	Date	2024-06-08	Field Position	59
RED				BLUE			
NOC	ANCEL CHLOE (FRA)			NOC	ZAYED FATIMA (SUI)		
Category	09 - Kata Female U21						
3 Points	2 Points	1 Point	Score	1 Point	2 Points	3 Points	
			20 : 21				
Penatlity				Penatlity			
			20.7:2 ..				
			Total	WINNER			

POINTS

Decision of Superiority

Judge 1	Judge 2	Judge 3	Judge 4	Judge 5	Judge 6	Judge 7	Referee

Name _____

Signature _____

Lion Cup 2024 Luxembourg

297 Rue de Reckenthal L-2410 Strassen, LUXEMBOURG

Court Nr.	1	Pool	1	Date	2024-06-08	Field Position	60
RED				BLUE			
NOC	DRUJON LUCILLE (FRA)			NOC	WU LISA (NED)		
Category	09 - Kata Female U21						
3 Points	2 Points	1 Point	Score	1 Point	2 Points	3 Points	
			22 : 22				
Penatlity				Penatlity			
			22.2:2 ..				
			Total	WINNER			

POINTS

Decision of Superiority

Judge 1	Judge 2	Judge 3	Judge 4	Judge 5	Judge 6	Judge 7	Referee

Name _____

Signature _____

Lion Cup 2024 Luxembourg

297 Rue de Reckenthal L-2410 Strassen, LUXEMBOURG

Court Nr.	1	Pool	1	Date	2024-06-08	Field Position	61
RED				BLUE			
NOC	LEITAO ROMANE (FRA)			NOC	STEENHUIJSEN EVA (NED)		
Category	09 - Kata Female U21						
3 Points	2 Points	1 Point	Score	1 Point	2 Points	3 Points	
			23 : 21				
Penatlity				Penatlity			
			23.1:2 ..				
WINNER			Total				

POINTS

Decision of Superiority

Judge 1	Judge 2	Judge 3	Judge 4	Judge 5	Judge 6	Judge 7	Referee

Name _____

Signature _____

Lion Cup 2024 Luxembourg

297 Rue de Reckenthal L-2410 Strassen, LUXEMBOURG

Court Nr.	1	Pool	1	Date	2024-06-08	Field Position	62
RED				BLUE			
NOC	ZAYED FATIMA (SUI)			NOC	WU LISA (NED)		
Category	09 - Kata Female U21						
3 Points	2 Points	1 Point	Score	1 Point	2 Points	3 Points	
			21 : 23				
Penatlity				Penatlity			
			21.7:2 ..				
			Total	WINNER			

POINTS

Decision of Superiority

Judge 1	Judge 2	Judge 3	Judge 4	Judge 5	Judge 6	Judge 7	Referee

Name _____

Signature _____

Lion Cup 2024 Luxembourg

297 Rue de Reckenthal L-2410 Strassen, LUXEMBOURG

Court Nr.	1	Pool	1	Date	2024-06-08	Field Position	63
RED				BLUE			
NOC	LEITAO ROMANE (FRA)			NOC	WU LISA (NED)		
Category	09 - Kata Female U21						
3 Points	2 Points	1 Point	Score	1 Point	2 Points	3 Points	
			23 : 23				
Penatlity					Penatlity		
				23.5:2 ..			
WINNER				Total			

POINTS

Decision of Superiority

Judge 1	Judge 2	Judge 3	Judge 4	Judge 5	Judge 6	Judge 7	Referee

Name _____

Signature _____

Lion Cup 2024 Luxembourg

297 Rue de Reckenthal L-2410 Strassen, LUXEMBOURG

Court Nr.	1	Pool	1	Date	2024-06-08	Field Position	0
RED				BLUE			
NOC	SCUFLAIRE EMMA (BEL)			NOC	STEENHUIJSEN EVA (NED)		
Category	09 - Kata Female U21						
3 Points	2 Points	1 Point	Score	1 Point	2 Points	3 Points	
			20 : 21				
Penatlity				Penatlity			
			20.2:2 ..				
			Total	WINNER			

POINTS

Decision of Superiority

Judge 1	Judge 2	Judge 3	Judge 4	Judge 5	Judge 6	Judge 7	Referee

Name _____

Signature _____

Lion Cup 2024 Luxembourg

297 Rue de Reckenthal L-2410 Strassen, LUXEMBOURG

Court Nr.	2	Pool	2	Date	2024-06-08	Field Position	0
RED				BLUE			
NOC	DRUJON LUCILLE (FRA)			NOC	ZAYED FATIMA (SUI)		
Category	09 - Kata Female U21						
3 Points	2 Points	1 Point	Score	1 Point	2 Points	3 Points	
			22 : 21				
Penatlity					Penatlity		
				22.3:2 ..			
WINNER				Total			

POINTS

Decision of Superiority

Judge 1	Judge 2	Judge 3	Judge 4	Judge 5	Judge 6	Judge 7	Referee

Name _____

Signature _____

Official Results

09 - Kata Female U21			
1	LEITAO ROMANE		FRA - FRANCE
2	WU LISA		NED - NETHERLANDS
3	STEENHUIJSEN EVA		NED - NETHERLANDS
3	DRUJON LUCILLE		FRA - FRANCE
5	SCUFLAIRE EMMA		BEL - BELGIUM
5	ZAYED FATIMA		SUI - SWITZERLAND

11 - KATA FEMALE SENIOR

Lion Cup 2024 Luxembourg

ENTRIES BY WEIGHT CATEGORY
11 - Kata Female Senior

As of 8 JUN 2024

NOC Code	Gender	Name	Seeding
BEL	F	Henroteaux Lou	
BEL	F	LENARTZ Maeva	
BEL	F	MILER Gelsey	
BEL	F	Scuflaire Emma	
FRA	F	BAUDARD LAURE	
FRA	F	DRUJON Lucille	
FRA	F	DRUJON Maelle	
FRA	F	GUILLAUME Cassandre	
FRA	F	LEITAO Romane	
LUX	F	Reding Mia	
LUX	F	Rodrigo Sarah	
LUX	F	Rossy Mauricio Iana	
NED	F	Beets Caitlin	
NED	F	Steenhuijsen Eva	
NED	F	Wu Lisa	
SUI	F	Eiselt Zoe	
SUI	F	Fortunato Emma	
SUI	F	Gallimore Kim	
SUI	F	Ritz Lila	
SUI	F	Tschanz Olivia	
SUI	F	Zayed Fatima	
SWE	F	Sökare Felicia	
WAL	F	Lewis Chloe	

11 - Kata Female Senior

Lion Cup 2024 Luxembourg, 297 Rue de Reckenthal L-2410 Strassen, LUX

2024-06-07

Tatami
1 19:20

Pool
1/2

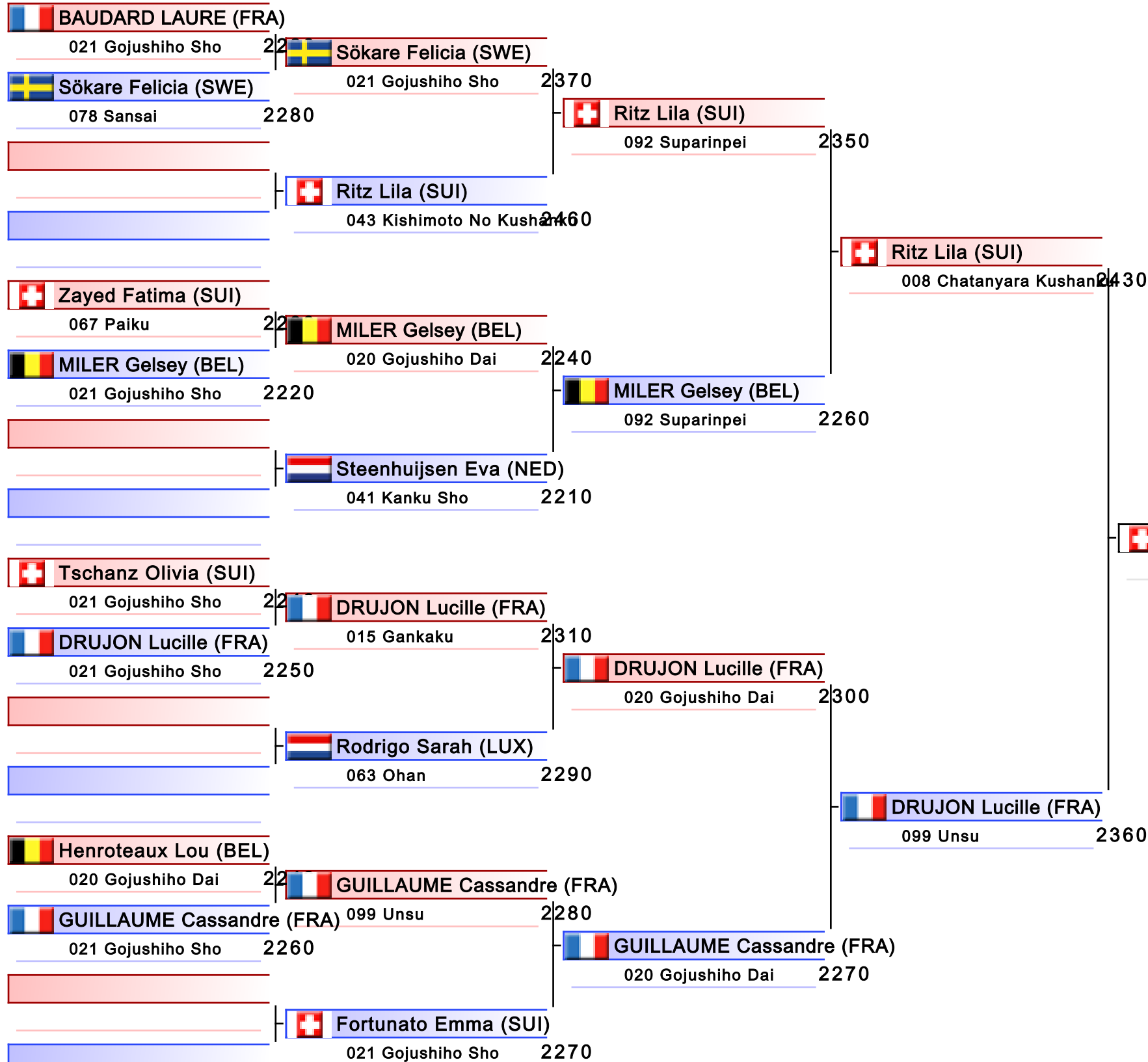

1. RITZ LILA (SUI)
2. LEITAO ROMANE (FRA)
3. WU LISA (NED)
3. SÖKARE FELICIA (SWE)
5. DRUJON MAELLE (FRA)
5. DRUJON LUCILLE (FRA)
7. EISELT ZOE (SUI)
7. MILER GELSEY (BEL)

11 - Kata Female Senior

Lion Cup 2024 Luxembourg, 297 Rue de Reckenthal L-2410 Strassen, LUX

2024-06-07

Tatami

2 19:15

Pool

2 / 2

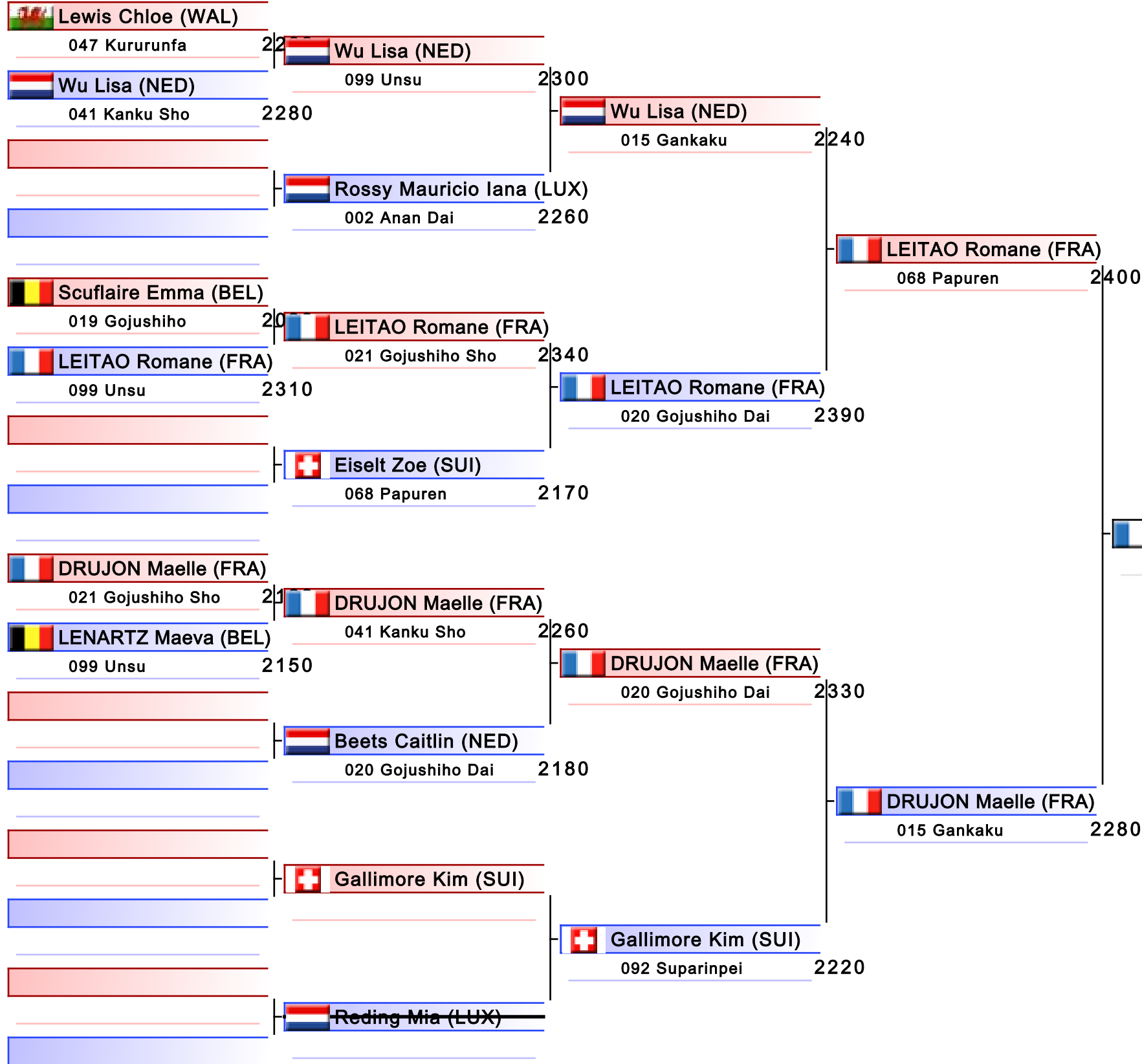

1. RITZ LILA (SUI)
2. LEITAO ROMANE (FRA)
3. WU LISA (NED)
3. SÖKARE FELICIA (SWE)
5. DRUJON MAELLE (FRA)
5. DRUJON LUCILLE (FRA)
7. EISELT ZOE (SUI)
7. MILER GELSEY (BEL)

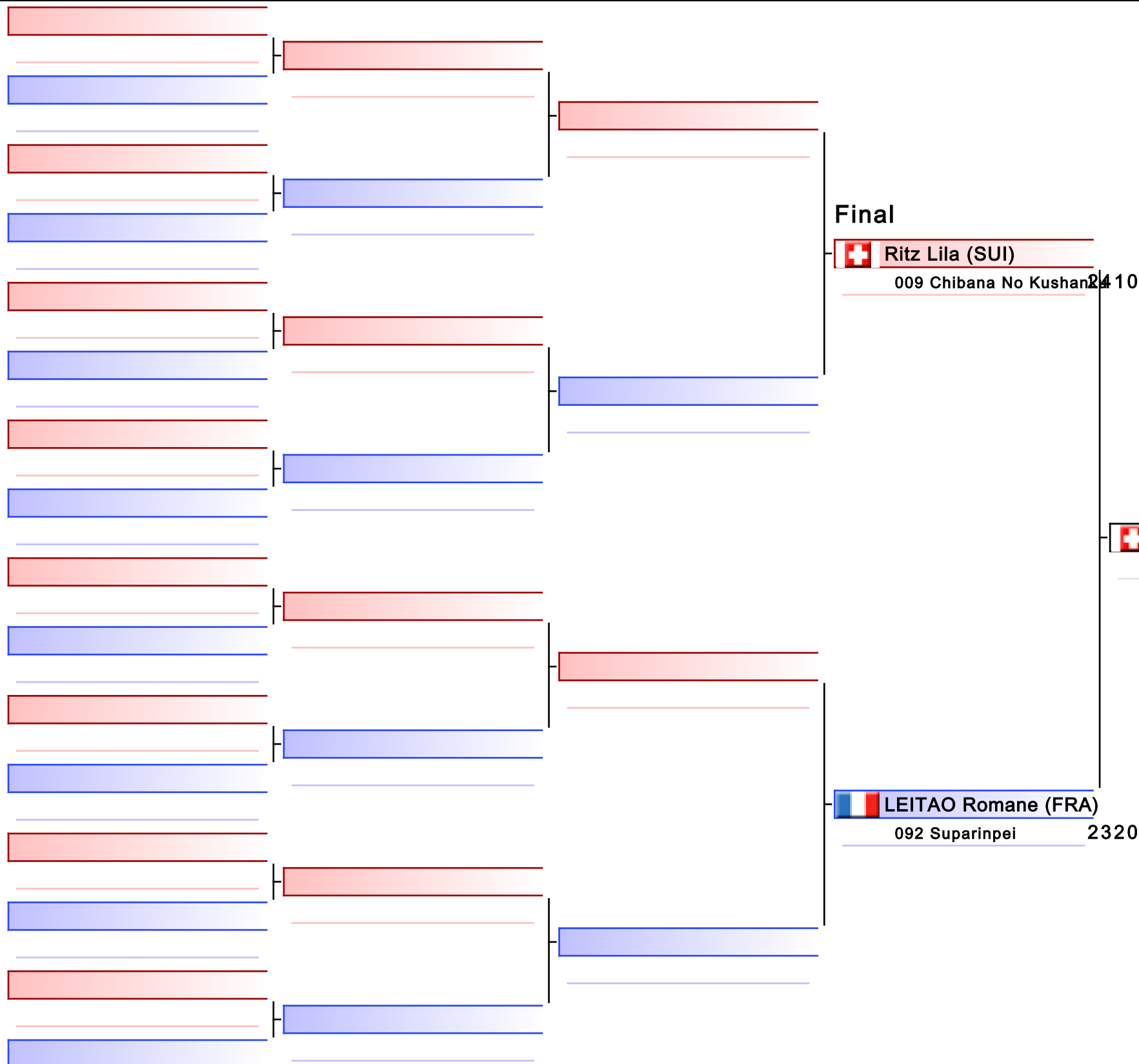

Ritz Lila (SUI)

1. RITZ LILA (SUI)
2. LEITAO ROMANE (FRA)
3. WU LISA (NED)
3. SÖKARE FELICIA (SWE)
5. DRUJON MAELLE (FRA)
5. DRUJON LUCILLE (FRA)
7. EISELT ZOE (SUI)
7. MILER GELSEY (BEL)

11 - Kata Female Senior

Lion Cup 2024 Luxembourg

2024-06-07

Tatami
1 20:15

Pool
1

(c)sportdata GmbH & Co KG 2000-2024 (2024-06-08 18:41) v 10.1.0 build 1 (2024-01-24 23:23 CET) License: Online_Event_ID-7672_LionCup2024Luxembourg (expire 2024-06-21)

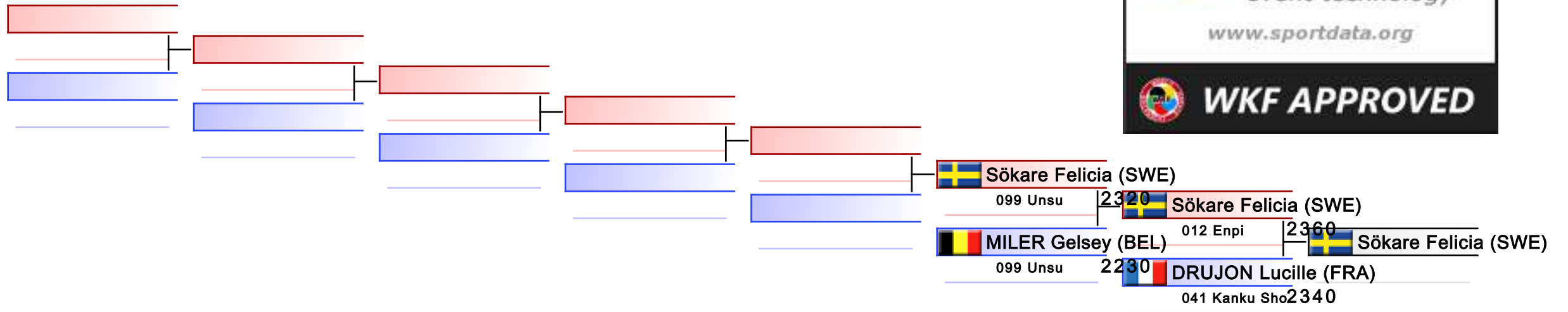

REPECHAGE: (1)

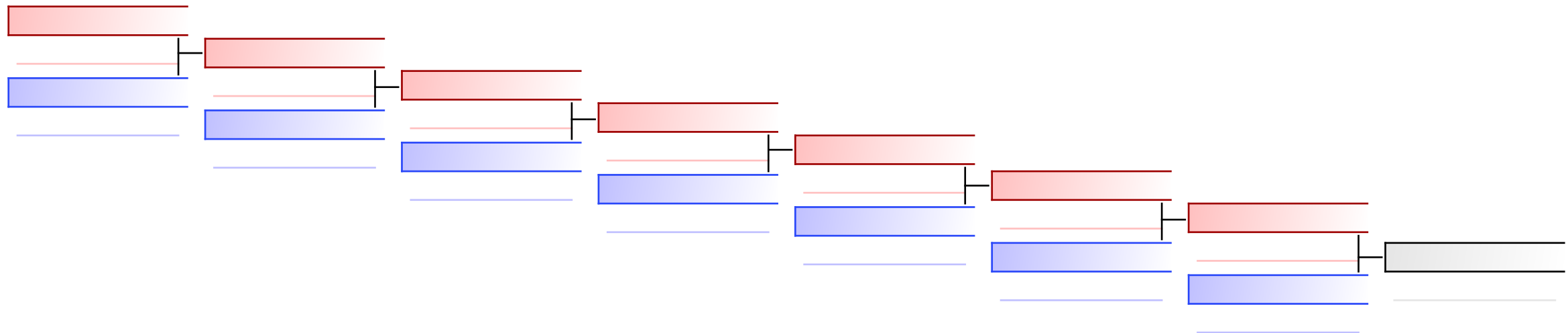

11 - Kata Female Senior

Lion Cup 2024 Luxembourg

2024-06-07

Tatami
2 20:05

Pool
2

(c)sportdata GmbH & Co KG 2000-2024 (2024-06-08 18:41) v 10.1.0 build 1 (2024-01-24 23:23 CET) License: Online_Event_ID-7672_LionCup2024Luxembourg (expire 2024-06-21)

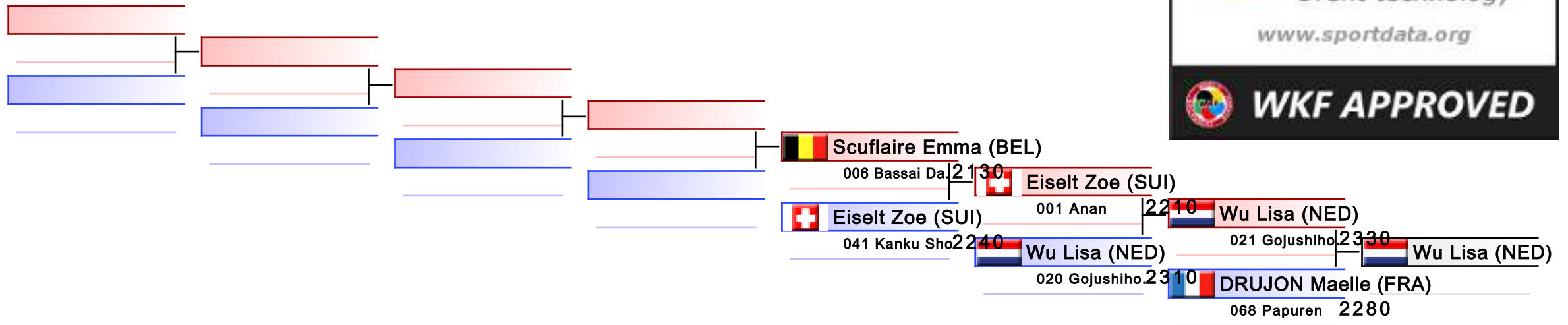

REPECHAGE: (2)

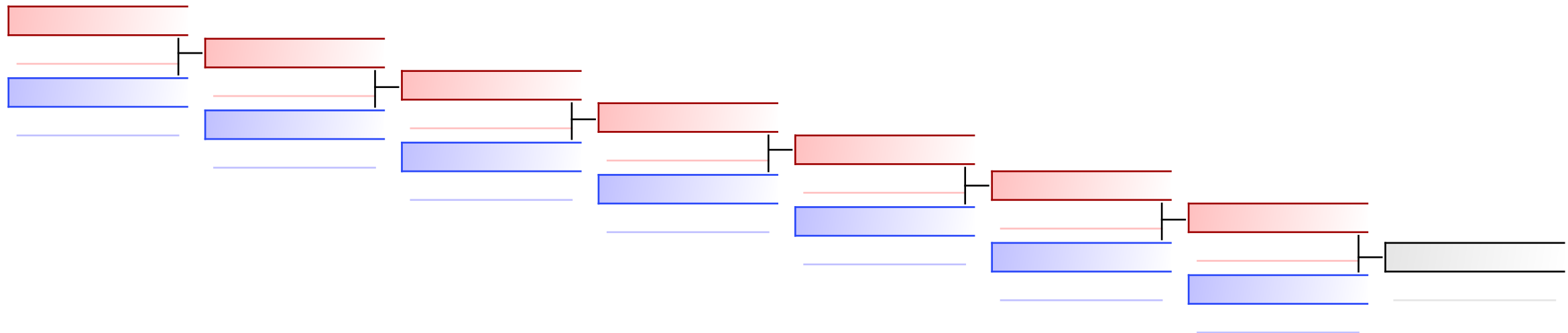

Lion Cup 2024 Luxembourg

297 Rue de Reckenthal L-2410 Strassen, LUXEMBOURG

Court Nr.	1	Pool	1	Date	2024-06-08	Field Position	49
RED				BLUE			
NOC	BAUDARD LAURE (FRA)			NOC	SKARE FELICIA (SWE)		
Category	11 - Kata Female Senior						
3 Points	2 Points	1 Point	Score	1 Point	2 Points	3 Points	
			22 : 22				
Penatlity					Penatlity		
				22.8:2 ..			
				Total	WINNER		

POINTS

Decision of Superiority

Judge 1	Judge 2	Judge 3	Judge 4	Judge 5	Judge 6	Judge 7	Referee

Name _____

Signature _____

Lion Cup 2024 Luxembourg

297 Rue de Reckenthal L-2410 Strassen, LUXEMBOURG

Court Nr.	1	Pool	1	Date	2024-06-08	Field Position	51
RED				BLUE			
NOC	ZAYED FATIMA (SUI)			NOC	MILER GELSEY (BEL)		
Category	11 - Kata Female Senior						
3 Points	2 Points	1 Point	Score	1 Point	2 Points	3 Points	
			22 : 22				
Penatlity				Penatlity			
			22.0:2 ..				
			Total	WINNER			

POINTS

Decision of Superiority

Judge 1	Judge 2	Judge 3	Judge 4	Judge 5	Judge 6	Judge 7	Referee

Name _____

Signature _____

Lion Cup 2024 Luxembourg

297 Rue de Reckenthal L-2410 Strassen, LUXEMBOURG

Court Nr.	1	Pool	1	Date	2024-06-08	Field Position	53
RED				BLUE			
NOC	TSCHANZ OLIVIA (SUI)			NOC	DRUJON LUCILLE (FRA)		
Category	11 - Kata Female Senior						
3 Points	2 Points	1 Point	Score	1 Point	2 Points	3 Points	
			22 : 22				
Penatlity				Penatlity			
			22.4:2 ..				
			Total	WINNER			

POINTS

Decision of Superiority

Judge 1	Judge 2	Judge 3	Judge 4	Judge 5	Judge 6	Judge 7	Referee

Name _____

Signature _____

Lion Cup 2024 Luxembourg

297 Rue de Reckenthal L-2410 Strassen, LUXEMBOURG

Court Nr.	1	Pool	1	Date	2024-06-08	Field Position	55
RED				BLUE			
NOC	HENROTEAUX LOU (BEL)			NOC	GUILLAUME CASSANDRE (FRA)		
Category	11 - Kata Female Senior						
3 Points	2 Points	1 Point	Score	1 Point	2 Points	3 Points	
			22 : 22				
Penatlity				Penatlity			
			22.4:2 ..				
			Total	WINNER			

POINTS

Decision of Superiority

Judge 1	Judge 2	Judge 3	Judge 4	Judge 5	Judge 6	Judge 7	Referee

Name _____

Signature _____

Lion Cup 2024 Luxembourg

297 Rue de Reckenthal L-2410 Strassen, LUXEMBOURG

Court Nr.	1	Pool	1	Date	2024-06-08	Field Position	57
RED				BLUE			
NOC	SKARE FELICIA (SWE)			NOC	RITZ LILA (SUI)		
Category	11 - Kata Female Senior						
3 Points	2 Points	1 Point	Score	1 Point	2 Points	3 Points	
			23 : 24				
Penatlity				Penatlity			
			23.7:2 ..				
			Total	WINNER			

POINTS

Decision of Superiority

Judge 1	Judge 2	Judge 3	Judge 4	Judge 5	Judge 6	Judge 7	Referee

Name _____

Signature _____

Lion Cup 2024 Luxembourg

297 Rue de Reckenthal L-2410 Strassen, LUXEMBOURG

Court Nr.	1	Pool	1	Date	2024-06-08	Field Position	58
RED				BLUE			
NOC	MILER GELSEY (BEL)			NOC	STEENHUIJSEN EVA (NED)		
Category	11 - Kata Female Senior						
3 Points	2 Points	1 Point	Score	1 Point	2 Points	3 Points	
			22 : 22				
Penatlity				Penatlity			
			22.4:2 ..				
WINNER			Total				

POINTS

Decision of Superiority

Judge 1	Judge 2	Judge 3	Judge 4	Judge 5	Judge 6	Judge 7	Referee

Name _____

Signature _____

Lion Cup 2024 Luxembourg

297 Rue de Reckenthal L-2410 Strassen, LUXEMBOURG

Court Nr.	1	Pool	1	Date	2024-06-08	Field Position	59
RED				BLUE			
NOC	DRUJON LUCILLE (FRA)			NOC	RODRIGO SARAH (LUX)		
Category	11 - Kata Female Senior						
3 Points	2 Points	1 Point	Score	1 Point	2 Points	3 Points	
			23 : 22				
Penatlity				Penatlity			
			23.1:2 ..				
WINNER			Total				

POINTS

Decision of Superiority

Judge 1	Judge 2	Judge 3	Judge 4	Judge 5	Judge 6	Judge 7	Referee

Name _____

Signature _____

Lion Cup 2024 Luxembourg

297 Rue de Reckenthal L-2410 Strassen, LUXEMBOURG

Court Nr.	1	Pool	1	Date	2024-06-08	Field Position	60
RED				BLUE			
NOC	GUILLAUME CASSANDRE (FRA)			NOC	FORTUNATO EMMA (SUI)		
Category	11 - Kata Female Senior						
3 Points	2 Points	1 Point	Score	1 Point	2 Points	3 Points	
			22 : 22				
Penatlity				Penatlity			
			22.8:2 ..				
WINNER			Total				

POINTS

Decision of Superiority

Judge 1	Judge 2	Judge 3	Judge 4	Judge 5	Judge 6	Judge 7	Referee

Name _____

Signature _____

Lion Cup 2024 Luxembourg

297 Rue de Reckenthal L-2410 Strassen, LUXEMBOURG

Court Nr.	1	Pool	1	Date	2024-06-08	Field Position	61
RED				BLUE			
NOC	RITZ LILA (SUI)			NOC	MILER GELSEY (BEL)		
Category	11 - Kata Female Senior						
3 Points	2 Points	1 Point	Score	1 Point	2 Points	3 Points	
			23 : 22				
Penatlity				Penatlity			
			23.5:2 ..				
WINNER			Total				

POINTS

Decision of Superiority

Judge 1	Judge 2	Judge 3	Judge 4	Judge 5	Judge 6	Judge 7	Referee

Name _____

Signature _____

Lion Cup 2024 Luxembourg

297 Rue de Reckenthal L-2410 Strassen, LUXEMBOURG

Court Nr.	1	Pool	1	Date	2024-06-08	Field Position	62
RED				BLUE			
NOC	DRUJON LUCILLE (FRA)			NOC	GUILLAUME CASSANDRE (FRA)		
Category	11 - Kata Female Senior						
3 Points	2 Points	1 Point	Score	1 Point	2 Points	3 Points	
			23 : 22				
Penatlity				Penatlity			
			23.0:2 ..				
WINNER			Total				

POINTS

Decision of Superiority

Judge 1	Judge 2	Judge 3	Judge 4	Judge 5	Judge 6	Judge 7	Referee

Name _____

Signature _____

Lion Cup 2024 Luxembourg

297 Rue de Reckenthal L-2410 Strassen, LUXEMBOURG

Court Nr.	1	Pool	1	Date	2024-06-08	Field Position	63
RED				BLUE			
NOC	RITZ LILA (SUI)			NOC	DRUJON LUCILLE (FRA)		
Category	11 - Kata Female Senior						
3 Points	2 Points	1 Point	Score	1 Point	2 Points	3 Points	
			24 : 23				
Penatlity				Penatlity			
			24.3:2 ..				
WINNER			Total				

POINTS

Decision of Superiority

Judge 1	Judge 2	Judge 3	Judge 4	Judge 5	Judge 6	Judge 7	Referee

Name _____

Signature _____

Lion Cup 2024 Luxembourg

297 Rue de Reckenthal L-2410 Strassen, LUXEMBOURG

Court Nr.	2	Pool	2	Date	2024-06-08	Field Position	49
RED				BLUE			
NOC	LEWIS CHLOE (WAL)			NOC	WU LISA (NED)		
Category	11 - Kata Female Senior						
3 Points	2 Points	1 Point	Score	1 Point	2 Points	3 Points	
			22 : 22				
Penatlity				Penatlity			
			22.0:2 ..				
			Total	WINNER			

POINTS

Decision of Superiority

Judge 1	Judge 2	Judge 3	Judge 4	Judge 5	Judge 6	Judge 7	Referee

Name _____

Signature _____

Lion Cup 2024 Luxembourg

297 Rue de Reckenthal L-2410 Strassen, LUXEMBOURG

Court Nr.	2	Pool	2	Date	2024-06-08	Field Position	51
RED				BLUE			
NOC	SCUFLAIRE EMMA (BEL)			NOC	LEITAO ROMANE (FRA)		
Category	11 - Kata Female Senior						
3 Points	2 Points	1 Point	Score	1 Point	2 Points	3 Points	
			20 : 23				
Penatlity				Penatlity			
			20.3:2 ..				
			Total	WINNER			

POINTS

Decision of Superiority

Judge 1	Judge 2	Judge 3	Judge 4	Judge 5	Judge 6	Judge 7	Referee

Name _____

Signature _____

Lion Cup 2024 Luxembourg

297 Rue de Reckenthal L-2410 Strassen, LUXEMBOURG

Court Nr.	2	Pool	2	Date	2024-06-08	Field Position	53
RED				BLUE			
NOC	DRUJON MAELLE (FRA)			NOC	LENARTZ MAEVA (BEL)		
Category	11 - Kata Female Senior						
3 Points	2 Points	1 Point	Score	1 Point	2 Points	3 Points	
			21 : 21				
Penatlity				Penatlity			
			21.8:2 ..				
WINNER			Total				

POINTS

Decision of Superiority

Judge 1	Judge 2	Judge 3	Judge 4	Judge 5	Judge 6	Judge 7	Referee

Name _____

Signature _____

Lion Cup 2024 Luxembourg

297 Rue de Reckenthal L-2410 Strassen, LUXEMBOURG

Court Nr.	2	Pool	2	Date	2024-06-08	Field Position	57
RED				BLUE			
NOC	WU LISA (NED)			NOC	ROSSY MAURICIO IANA (LUX)		
Category	11 - Kata Female Senior						
3 Points	2 Points	1 Point	Score	1 Point	2 Points	3 Points	
			23 : 22				
Penatlity				Penatlity			
			23.0:2 ..				
WINNER			Total				

POINTS

Decision of Superiority

Judge 1	Judge 2	Judge 3	Judge 4	Judge 5	Judge 6	Judge 7	Referee

Name _____

Signature _____

Lion Cup 2024 Luxembourg

297 Rue de Reckenthal L-2410 Strassen, LUXEMBOURG

Court Nr.	2	Pool	2	Date	2024-06-08	Field Position	58
RED				BLUE			
NOC	LEITAO ROMANE (FRA)			NOC	EISELT ZOE (SUI)		
Category	11 - Kata Female Senior						
3 Points	2 Points	1 Point	Score	1 Point	2 Points	3 Points	
			23 : 21				
Penatlity					Penatlity		
				23.4:2 ..			
WINNER				Total			

POINTS

Decision of Superiority

Judge 1	Judge 2	Judge 3	Judge 4	Judge 5	Judge 6	Judge 7	Referee

Name _____

Signature _____

Lion Cup 2024 Luxembourg

297 Rue de Reckenthal L-2410 Strassen, LUXEMBOURG

Court Nr.	2	Pool	2	Date	2024-06-08	Field Position	59
RED				BLUE			
NOC	DRUJON MAELLE (FRA)			NOC	BEETS CAITLIN (NED)		
Category	11 - Kata Female Senior						
3 Points	2 Points	1 Point	Score	1 Point	2 Points	3 Points	
			22 : 21				
Penatlity				Penatlity			
			22.6:2 ..				
WINNER			Total				

POINTS

Decision of Superiority

Judge 1	Judge 2	Judge 3	Judge 4	Judge 5	Judge 6	Judge 7	Referee

Name _____

Signature _____

Lion Cup 2024 Luxembourg

297 Rue de Reckenthal L-2410 Strassen, LUXEMBOURG

Court Nr.	2	Pool	2	Date	2024-06-08	Field Position	61
RED				BLUE			
NOC	WU LISA (NED)			NOC	LEITAO ROMANE (FRA)		
Category	11 - Kata Female Senior						
3 Points	2 Points	1 Point	Score	1 Point	2 Points	3 Points	
			22 : 23				
Penatlity				Penatlity			
			22.4:2 ..				
			Total	WINNER			

POINTS

Decision of Superiority

Judge 1	Judge 2	Judge 3	Judge 4	Judge 5	Judge 6	Judge 7	Referee

Name _____

Signature _____

Lion Cup 2024 Luxembourg

297 Rue de Reckenthal L-2410 Strassen, LUXEMBOURG

Court Nr.	2	Pool	2	Date	2024-06-08	Field Position	62
RED				BLUE			
NOC	DRUJON MAELLE (FRA)			NOC	GALLIMORE KIM (SUI)		
Category	11 - Kata Female Senior						
3 Points	2 Points	1 Point	Score	1 Point	2 Points	3 Points	
			23 : 22				
Penatlity				Penatlity			
			23.3:2 ..				
WINNER			Total				

POINTS

Decision of Superiority

Judge 1	Judge 2	Judge 3	Judge 4	Judge 5	Judge 6	Judge 7	Referee

Name _____

Signature _____

Lion Cup 2024 Luxembourg

297 Rue de Reckenthal L-2410 Strassen, LUXEMBOURG

Court Nr.	2	Pool	2	Date	2024-06-08	Field Position	63
RED				BLUE			
NOC	LEITAO ROMANE (FRA)			NOC	DRUJON MAELLE (FRA)		
Category	11 - Kata Female Senior						
3 Points	2 Points	1 Point	Score	1 Point	2 Points	3 Points	
			24 : 22				
Penatlity				Penatlity			
			24.0:2 ..				
WINNER			Total				

POINTS

Decision of Superiority

Judge 1	Judge 2	Judge 3	Judge 4	Judge 5	Judge 6	Judge 7	Referee

Name _____

Signature _____

Lion Cup 2024 Luxembourg

297 Rue de Reckenthal L-2410 Strassen, LUXEMBOURG

Court Nr.	1	Pool	1	Date	2024-06-08	Field Position	63
RED				BLUE			
NOC	RITZ LILA (SUI)			NOC	LEITAO ROMANE (FRA)		
Category	11 - Kata Female Senior						
3 Points	2 Points	1 Point	Score	1 Point	2 Points	3 Points	
			24 : 23				
Penatlity				Penatlity			
			24.1:2 ..				
WINNER			Total				

POINTS

Decision of Superiority

Judge 1	Judge 2	Judge 3	Judge 4	Judge 5	Judge 6	Judge 7	Referee

Name _____

Signature _____

Lion Cup 2024 Luxembourg

297 Rue de Reckenthal L-2410 Strassen, LUXEMBOURG

Court Nr.	1	Pool	1	Date	2024-06-08	Field Position	0
RED				BLUE			
NOC	SKARE FELICIA (SWE)			NOC	DRUJON LUCILLE (FRA)		
Category	11 - Kata Female Senior						
3 Points	2 Points	1 Point	Score	1 Point	2 Points	3 Points	
			23 : 23				
Penatlity				Penatlity			
			23.6:2 ..				
WINNER			Total				

POINTS

Decision of Superiority

Judge 1	Judge 2	Judge 3	Judge 4	Judge 5	Judge 6	Judge 7	Referee

Name _____

Signature _____

Lion Cup 2024 Luxembourg

297 Rue de Reckenthal L-2410 Strassen, LUXEMBOURG

Court Nr.	1	Pool	1	Date	2024-06-08	Field Position	2
RED				BLUE			
NOC	SKARE FELICIA (SWE)			NOC	MILER GELSEY (BEL)		
Category	11 - Kata Female Senior						
3 Points	2 Points	1 Point	Score	1 Point	2 Points	3 Points	
			23 : 22				
Penatlity				Penatlity			
			23.2:2 ..				
WINNER			Total				

POINTS

Decision of Superiority

Judge 1	Judge 2	Judge 3	Judge 4	Judge 5	Judge 6	Judge 7	Referee

Name _____

Signature _____

Lion Cup 2024 Luxembourg - 2024-06-07

Official Results

11 - Kata Female Senior			
1	RITZ LILA		SUI - SWITZERLAND
2	LEITAO ROMANE		FRA - FRANCE
3	WU LISA		NED - NETHERLANDS
3	SÖKARE FELICIA		SWE - SWEDEN
5	DRUJON MAELLE		FRA - FRANCE
5	DRUJON LUCILLE		FRA - FRANCE
7	EISELT ZOE		SUI - SWITZERLAND
7	MILER GELSEY		BEL - BELGIUM
9	SCUFLAIRE EMMA		BEL - BELGIUM

17 - KATA MALE U14

Lion Cup 2024 Luxembourg

ENTRIES BY WEIGHT CATEGORY
17 - Kata Male U14

As of 8 JUN 2024

NOC Code	Gender	Name	Seeding
BEL	M	Albu David	
BEL	M	Degée Louis	
BEL	M	Dernoncourt Sofiane	
FRA	M	Donghia ALESSIO	
FRA	M	DUPUIS Léo	
FRA	M	HART Enoha	
FRA	M	NGUYEN ERVIN	
LUX	M	Jesus Pereira Matias	
LUX	M	Pan Jaxon	
SUI	M	Limacher Ramon	
WAL	M	Lewis Caian	

17 - Kata Male U14

Lion Cup 2024 Luxembourg, 297 Rue de Reckenthal L-2410 Strassen, LUX

2024-06-07

Tatami
5 18:45

Pool
1/1

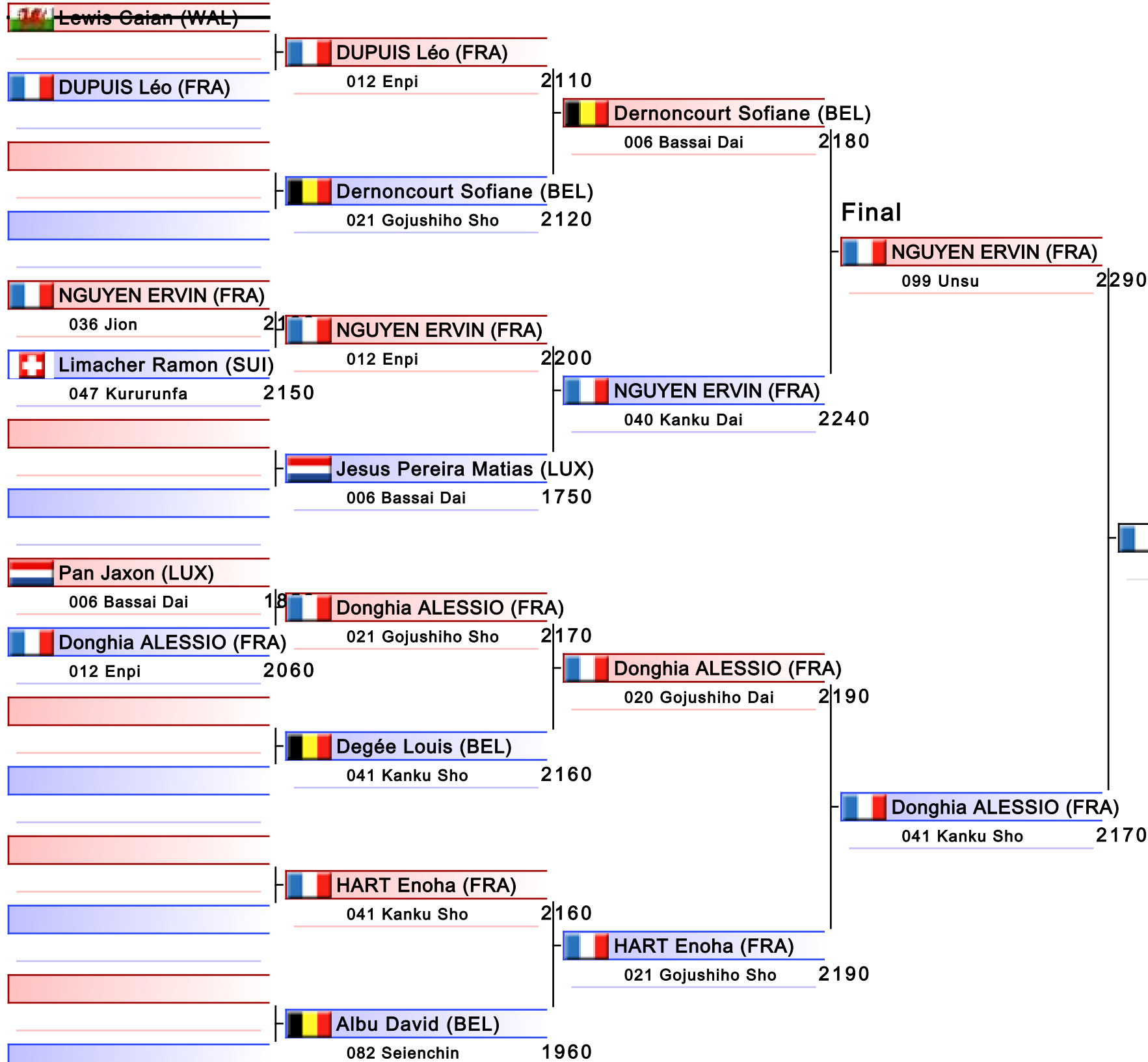

1. NGUYEN ERVIN (FRA)
2. DONGHIA ALESSIO (FRA)
3. DERNONCOURT SOFIANE (BEL)
3. DEGÉE LOUIS (BEL)
5. LIMACHER RAMON (SUI)
5. HART ENOHA (FRA)
7. JESUS PEREIRA MATIAS (LUX)
7. PAN JAXON (LUX)

17 - Kata Male U14

Lion Cup 2024 Luxembourg

2024-06-07

Tatami
5 19:30

Pool
1

(c)sportdata GmbH & Co KG 2000-2024 (2024-06-08 18:41) v 10.1.0 build 1 (2024-01-24 23:23 CET) License: Online_Event_ID-7672_LionCup2024Luxembourg (expire 2024-06-21)

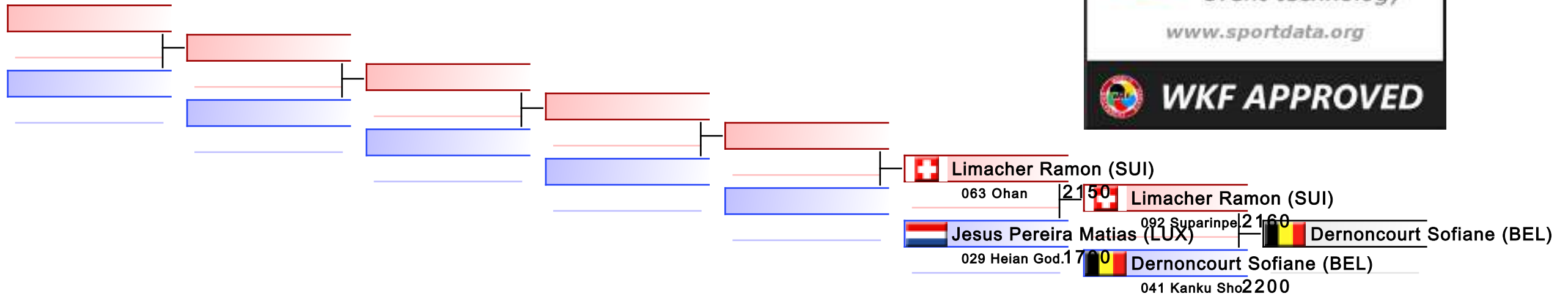

REPECHAGE: (1)

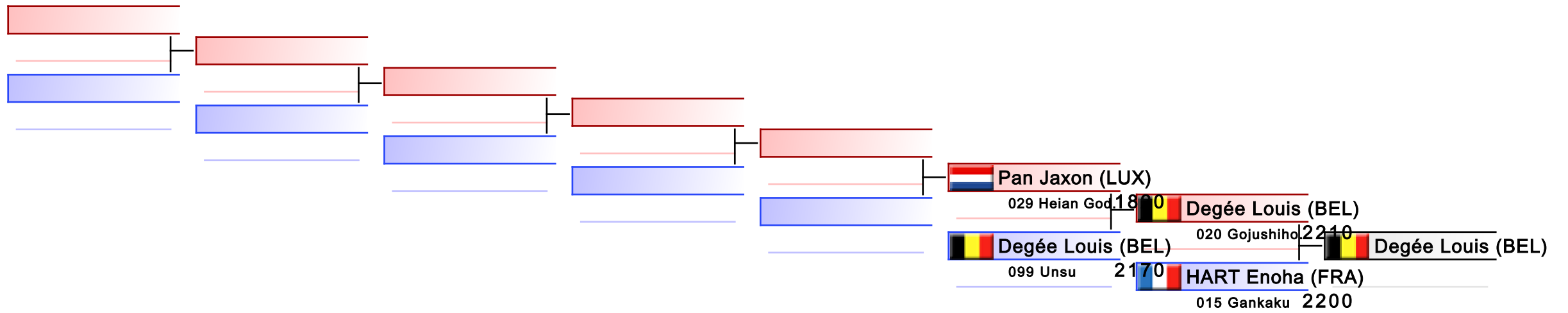

Lion Cup 2024 Luxembourg

297 Rue de Reckenthal L-2410 Strassen, LUXEMBOURG

Court Nr.	1	Pool	1	Date	2024-06-08	Field Position	51
RED				BLUE			
NOC	NGUYEN ERVIN (FRA)			NOC	LIMACHER RAMON (SUI)		
Category	17 - Kata Male U14						
3 Points	2 Points	1 Point	Score	1 Point	2 Points	3 Points	
			:				
Penatlity				Penatlity			
			Total				

Decision of Superiority

Judge 1	Judge 2	Judge 3	Judge 4	Judge 5	Judge 6	Judge 7	Referee

Name _____

Signature _____

Lion Cup 2024 Luxembourg

297 Rue de Reckenthal L-2410 Strassen, LUXEMBOURG

Court Nr.	1	Pool	1	Date	2024-06-08	Field Position	53
RED				BLUE			
NOC	PAN JAXON (LUX)			NOC	DONGHIA ALESSIO (FRA)		
Category	17 - Kata Male U14						
3 Points	2 Points	1 Point	Score	1 Point	2 Points	3 Points	
			:				
Penatlity				Penatlity			
			Total				

Decision of Superiority

Judge 1	Judge 2	Judge 3	Judge 4	Judge 5	Judge 6	Judge 7	Referee

Name _____

Signature _____

Lion Cup 2024 Luxembourg

297 Rue de Reckenthal L-2410 Strassen, LUXEMBOURG

Court Nr.	1	Pool	1	Date	2024-06-08	Field Position	57
RED				BLUE			
NOC	DUPUIS LO (FRA)			NOC	DERNONCOURT SOFIANE (BEL)		
Category	17 - Kata Male U14						
3 Points	2 Points	1 Point	Score	1 Point	2 Points	3 Points	
			:				
Penatlity				Penatlity			
			Total				

Decision of Superiority

Judge 1	Judge 2	Judge 3	Judge 4	Judge 5	Judge 6	Judge 7	Referee

Name _____

Signature _____

Lion Cup 2024 Luxembourg

297 Rue de Reckenthal L-2410 Strassen, LUXEMBOURG

Court Nr.	1	Pool	1	Date	2024-06-08	Field Position	58
RED				BLUE			
NOC	NGUYEN ERVIN (FRA)			NOC	JESUS PEREIRA MATIAS (LUX)		
Category	17 - Kata Male U14						
3 Points	2 Points	1 Point	Score	1 Point	2 Points	3 Points	
			:				
Penatlity				Penatlity			
			Total				

Decision of Superiority

Judge 1	Judge 2	Judge 3	Judge 4	Judge 5	Judge 6	Judge 7	Referee

Name _____

Signature _____

Lion Cup 2024 Luxembourg

297 Rue de Reckenthal L-2410 Strassen, LUXEMBOURG

Court Nr.	1	Pool	1	Date	2024-06-08	Field Position	59
RED				BLUE			
NOC	DONGHIA ALESSIO (FRA)			NOC	DEGE LOUIS (BEL)		
Category	17 - Kata Male U14						
3 Points	2 Points	1 Point	Score	1 Point	2 Points	3 Points	
			:				
Penatlity				Penatlity			
			Total				

Decision of Superiority

Judge 1	Judge 2	Judge 3	Judge 4	Judge 5	Judge 6	Judge 7	Referee

Name _____

Signature _____

Lion Cup 2024 Luxembourg

297 Rue de Reckenthal L-2410 Strassen, LUXEMBOURG

Court Nr.	1	Pool	1	Date	2024-06-08	Field Position	60
RED				BLUE			
NOC	HART ENOHA (FRA)			NOC	ALBU DAVID (BEL)		
Category	17 - Kata Male U14						
3 Points	2 Points	1 Point	Score	1 Point	2 Points	3 Points	
			:				
Penatlity				Penatlity			
			Total				

Decision of Superiority

Judge 1	Judge 2	Judge 3	Judge 4	Judge 5	Judge 6	Judge 7	Referee

Name _____

Signature _____

Lion Cup 2024 Luxembourg

297 Rue de Reckenthal L-2410 Strassen, LUXEMBOURG

Court Nr.	1	Pool	1	Date	2024-06-08	Field Position	61
RED				BLUE			
NOC	DERNONCOURT SOFIANE (BEL)			NOC	NGUYEN ERVIN (FRA)		
Category	17 - Kata Male U14						
3 Points	2 Points	1 Point	Score	1 Point	2 Points	3 Points	
			:				
Penatlity				Penatlity			
			Total				

Decision of Superiority

Judge 1	Judge 2	Judge 3	Judge 4	Judge 5	Judge 6	Judge 7	Referee

Name _____

Signature _____

Lion Cup 2024 Luxembourg

297 Rue de Reckenthal L-2410 Strassen, LUXEMBOURG

Court Nr.	1	Pool	1	Date	2024-06-08	Field Position	62
RED				BLUE			
NOC	DONGHIA ALESSIO (FRA)			NOC	HART ENOHA (FRA)		
Category	17 - Kata Male U14						
3 Points	2 Points	1 Point	Score	1 Point	2 Points	3 Points	
			:				
Penatlity				Penatlity			
			Total				

Decision of Superiority

Judge 1	Judge 2	Judge 3	Judge 4	Judge 5	Judge 6	Judge 7	Referee

Name _____

Signature _____

Lion Cup 2024 Luxembourg

297 Rue de Reckenthal L-2410 Strassen, LUXEMBOURG

Court Nr.	1	Pool	1	Date	2024-06-08	Field Position	63
RED				BLUE			
NOC	NGUYEN ERVIN (FRA)			NOC	DONGHIA ALESSIO (FRA)		
Category	17 - Kata Male U14						
3 Points	2 Points	1 Point	Score	1 Point	2 Points	3 Points	
			:				
Penatlity				Penatlity			
			Total				

Decision of Superiority

Judge 1	Judge 2	Judge 3	Judge 4	Judge 5	Judge 6	Judge 7	Referee

Name _____

Signature _____

Lion Cup 2024 Luxembourg

297 Rue de Reckenthal L-2410 Strassen, LUXEMBOURG

Court Nr.	1	Pool	1	Date	2024-06-08	Field Position	0
RED				BLUE			
NOC	LIMACHER RAMON (SUI)			NOC	DERNONCOURT SOFIANE (BEL)		
Category	17 - Kata Male U14						
3 Points	2 Points	1 Point	Score	1 Point	2 Points	3 Points	
			:				
Penatlity				Penatlity			
			Total				

Decision of Superiority

Judge 1	Judge 2	Judge 3	Judge 4	Judge 5	Judge 6	Judge 7	Referee

Name _____

Signature _____

Lion Cup 2024 Luxembourg

297 Rue de Reckenthal L-2410 Strassen, LUXEMBOURG

Court Nr.	1	Pool	1	Date	2024-06-08	Field Position	2
RED				BLUE			
NOC	LIMACHER RAMON (SUI)			NOC	JESUS PEREIRA MATIAS (LUX)		
Category	17 - Kata Male U14						
3 Points	2 Points	1 Point	Score	1 Point	2 Points	3 Points	
			:				
Penatlity				Penatlity			
			Total				

Decision of Superiority

Judge 1	Judge 2	Judge 3	Judge 4	Judge 5	Judge 6	Judge 7	Referee

Name _____

Signature _____

Lion Cup 2024 Luxembourg

297 Rue de Reckenthal L-2410 Strassen, LUXEMBOURG

Court Nr.	2	Pool	2	Date	2024-06-08	Field Position	0
RED				BLUE			
NOC	DEGE LOUIS (BEL)			NOC	HART ENOHA (FRA)		
Category	17 - Kata Male U14						
3 Points	2 Points	1 Point	Score	1 Point	2 Points	3 Points	
			:				
Penatlity				Penatlity			
			Total				

Decision of Superiority

Judge 1	Judge 2	Judge 3	Judge 4	Judge 5	Judge 6	Judge 7	Referee

Name _____

Signature _____

Lion Cup 2024 Luxembourg

297 Rue de Reckenthal L-2410 Strassen, LUXEMBOURG

Court Nr.	2	Pool	2	Date	2024-06-08	Field Position	2
RED				BLUE			
NOC	PAN JAXON (LUX)			NOC	DEGE LOUIS (BEL)		
Category	17 - Kata Male U14						
3 Points	2 Points	1 Point	Score	1 Point	2 Points	3 Points	
			:				
Penatlity				Penatlity			
			Total				

Decision of Superiority

Judge 1	Judge 2	Judge 3	Judge 4	Judge 5	Judge 6	Judge 7	Referee

Name _____

Signature _____

Lion Cup 2024 Luxembourg - 2024-06-07

Official Results

17 - Kata Male U14			
1	NGUYEN ERVIN		FRA - FRANCE
2	DONGHIA ALESSIO		FRA - FRANCE
3	DERNONCOURT SOFIANE		BEL - BELGIUM
3	DEGÉE LOUIS		BEL - BELGIUM
5	LIMACHER RAMON		SUI - SWITZERLAND
5	HART ENOHA		FRA - FRANCE
7	JESUS PEREIRA MATIAS		LUX - LUXEMBOURG
7	PAN JAXON		LUX - LUXEMBOURG

18 - KATA MALE U16

Lion Cup 2024 Luxembourg

ENTRIES BY WEIGHT CATEGORY
18 - Kata Male U16

As of 8 JUN 2024

NOC Code	Gender	Name	Seeding
BEL	M	EL MESBAHI younes	
BEL	M	Gilles Boschmans	
BEL	M	Marreda-le-Maignent Sasha	
FRA	M	Francais Killian	
FRA	M	GREGOIRE Loucyane	
FRA	M	Kunasuthan Santhosh	
FRA	M	Nguyen Thylane	
LUX	M	Dong Andy	
LUX	M	Soares Gonçalo	
SCO	M	Morrison Logan	
SUI	M	Dos Santos Samuel	
SUI	M	Lüthy Corsin Dion	
SUI	M	Mateus Gomes Cristiano	
SUI	M	Mateus Gomes Leonardo	
SUI	M	Soliaryk Platon	

18 - Kata Male U16

Lion Cup 2024 Luxembourg, 297 Rue de Reckenthal L-2410 Strassen, LUX

2024-06-07

Tatami
3 17:30

Pool
1 / 1

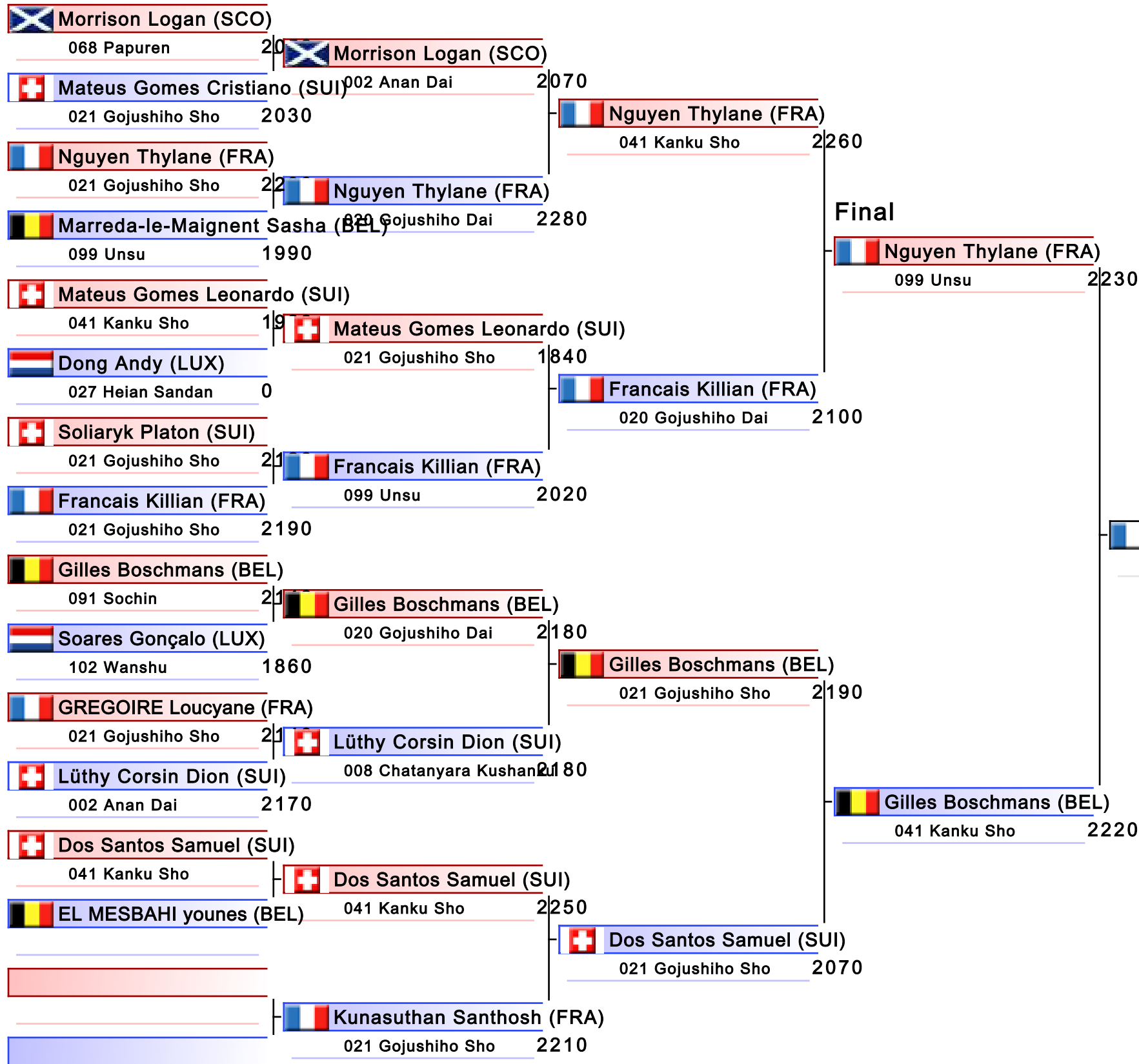

1. NGUYEN THYLANE (FRA)
2. GILLES BOSCHMANS (BEL)
3. FRANCAIS KILLIAN (FRA)
3. LÜTHY CORSIN DION (SUI)
5. MORRISON LOGAN (SCO)
5. DOS SANTOS SAMUEL (SUI)
7. MARREDA-LE-MAIGNENT SASHA (BEL)
7. SOARES GONÇALO (LUX)

18 - Kata Male U16

Lion Cup 2024 Luxembourg

2024-06-07

Tatami
3 18:35

Pool
1

(c)sportdata GmbH & Co KG 2000-2024 (2024-06-08 18:41) v 10.1.0 build 1 (2024-01-24 23:23 CET) License: Online_Event_ID-7672_LionCup2024Luxembourg (expire 2024-06-21)

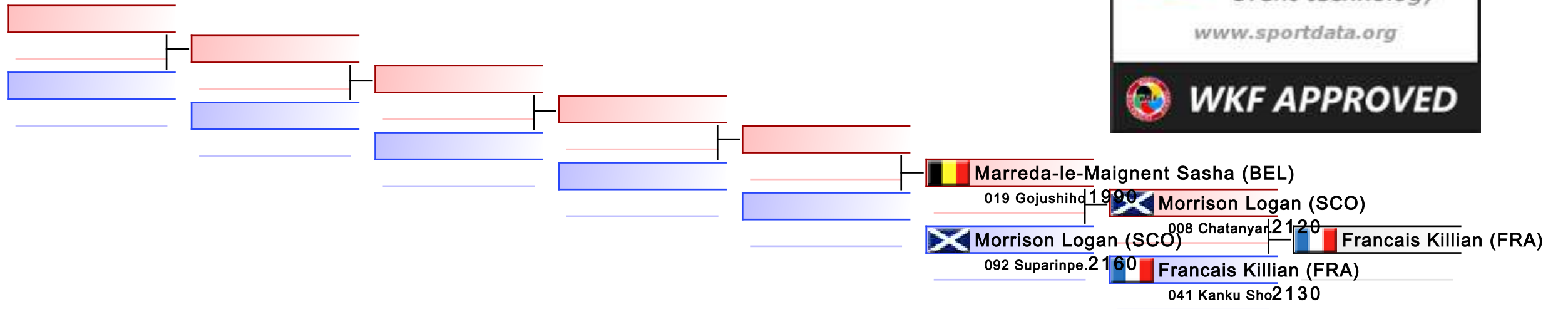

REPECHAGE: (1)

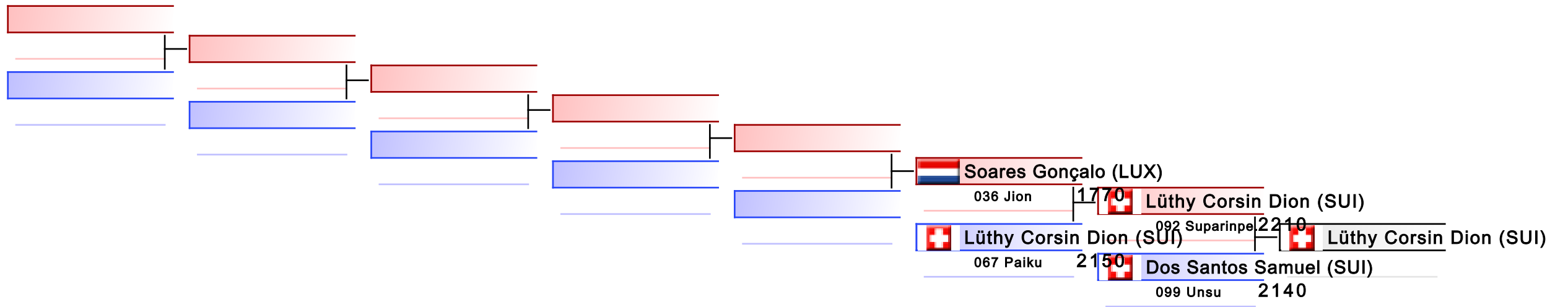

Lion Cup 2024 Luxembourg

297 Rue de Reckenthal L-2410 Strassen, LUXEMBOURG

Court Nr.	1	Pool	1	Date	2024-06-08	Field Position	49
RED				BLUE			
NOC	MORRISON LOGAN (SCO)			NOC	MATEUS GOMES CRISTIANO (SUI)		
Category	18 - Kata Male U16						
3 Points	2 Points	1 Point	Score	1 Point	2 Points	3 Points	
			20 : 20				
Penatlity				Penatlity			
			20.5:2 ..				
WINNER			Total				

POINTS

Decision of Superiority

Judge 1	Judge 2	Judge 3	Judge 4	Judge 5	Judge 6	Judge 7	Referee

Name _____

Signature _____

Lion Cup 2024 Luxembourg

297 Rue de Reckenthal L-2410 Strassen, LUXEMBOURG

Court Nr.	1	Pool	1	Date	2024-06-08	Field Position	50
RED				BLUE			
NOC	NGUYEN THYLANE (FRA)			NOC	MARREDA-LE-MAIGNENT SASHA (BEL)		
Category	18 - Kata Male U16						
3 Points	2 Points	1 Point	Score	1 Point	2 Points	3 Points	
			22 : 19				
Penatlity				Penatlity			
			22.3:1 ..				
WINNER			Total				

POINTS

Decision of Superiority

Judge 1	Judge 2	Judge 3	Judge 4	Judge 5	Judge 6	Judge 7	Referee

Name _____

Signature _____

Lion Cup 2024 Luxembourg

297 Rue de Reckenthal L-2410 Strassen, LUXEMBOURG

Court Nr.	1	Pool	1	Date	2024-06-08	Field Position	51
RED				BLUE			
NOC	MATEUS GOMES LEONARDO (SUI)			NOC	DONG ANDY (LUX)		
Category	18 - Kata Male U16						
3 Points	2 Points	1 Point	Score	1 Point	2 Points	3 Points	
			19 : 17				
Penatlity				Penatlity			
			19.8:1 ..				
WINNER			Total				

POINTS

Decision of Superiority

Judge 1	Judge 2	Judge 3	Judge 4	Judge 5	Judge 6	Judge 7	Referee

Name _____

Signature _____

Lion Cup 2024 Luxembourg

297 Rue de Reckenthal L-2410 Strassen, LUXEMBOURG

Court Nr.	1	Pool	1	Date	2024-06-08	Field Position	52
RED				BLUE			
NOC	SOLIARYK PLATON (SUI)			NOC	FRANCAIS KILLIAN (FRA)		
Category	18 - Kata Male U16						
3 Points	2 Points	1 Point	Score	1 Point	2 Points	3 Points	
			21 : 21				
Penatlity				Penatlity			
			21.2:2 ..				
			Total	WINNER			

POINTS

Decision of Superiority

Judge 1	Judge 2	Judge 3	Judge 4	Judge 5	Judge 6	Judge 7	Referee

Name _____

Signature _____

Lion Cup 2024 Luxembourg

297 Rue de Reckenthal L-2410 Strassen, LUXEMBOURG

Court Nr.	1	Pool	1	Date	2024-06-08	Field Position	53
RED				BLUE			
NOC	GILLES BOSCHMANS (BEL)			NOC	SOARES GONALO (LUX)		
Category	18 - Kata Male U16						
3 Points	2 Points	1 Point	Score	1 Point	2 Points	3 Points	
			21 : 18				
Penatlity				Penatlity			
			21.4:1 ..				
WINNER			Total				

POINTS

Decision of Superiority

Judge 1	Judge 2	Judge 3	Judge 4	Judge 5	Judge 6	Judge 7	Referee

Name _____

Signature _____

Lion Cup 2024 Luxembourg

297 Rue de Reckenthal L-2410 Strassen, LUXEMBOURG

Court Nr.	1	Pool	1	Date	2024-06-08	Field Position	54
RED				BLUE			
NOC	GREGOIRE LOUCYANE (FRA)			NOC	LTHY CORSIN DION (SUI)		
Category	18 - Kata Male U16						
3 Points	2 Points	1 Point	Score	1 Point	2 Points	3 Points	
			21 : 21				
Penatlity				Penatlity			
			21.4:2 ..				
			Total	WINNER			

POINTS

Decision of Superiority

Judge 1	Judge 2	Judge 3	Judge 4	Judge 5	Judge 6	Judge 7	Referee

Name _____

Signature _____

Lion Cup 2024 Luxembourg

297 Rue de Reckenthal L-2410 Strassen, LUXEMBOURG

Court Nr.	1	Pool	1	Date	2024-06-08	Field Position	55
RED				BLUE			
NOC	DOS SANTOS SAMUEL (SUI)			NOC	EL MESBAHI YOUNES (BEL)		
Category	18 - Kata Male U16						
3 Points	2 Points	1 Point	Score	1 Point	2 Points	3 Points	
			:				
Penatlity				Penatlity			
			Total				

Decision of Superiority

Judge 1	Judge 2	Judge 3	Judge 4	Judge 5	Judge 6	Judge 7	Referee

Name _____

Signature _____

Lion Cup 2024 Luxembourg

297 Rue de Reckenthal L-2410 Strassen, LUXEMBOURG

Court Nr.	1	Pool	1	Date	2024-06-08	Field Position	57
RED				BLUE			
NOC	MORRISON LOGAN (SCO)			NOC	NGUYEN THYLANE (FRA)		
Category	18 - Kata Male U16						
3 Points	2 Points	1 Point	Score	1 Point	2 Points	3 Points	
			20 : 22				
Penatlity				Penatlity			
			20.7:2 ..				
			Total	WINNER			

POINTS

Decision of Superiority

Judge 1	Judge 2	Judge 3	Judge 4	Judge 5	Judge 6	Judge 7	Referee

Name _____

Signature _____

Lion Cup 2024 Luxembourg

297 Rue de Reckenthal L-2410 Strassen, LUXEMBOURG

Court Nr.	1	Pool	1	Date	2024-06-08	Field Position	58
RED				BLUE			
NOC	MATEUS GOMES LEONARDO (SUI)			NOC	FRANCAIS KILLIAN (FRA)		
Category	18 - Kata Male U16						
3 Points	2 Points	1 Point	Score	1 Point	2 Points	3 Points	
			18 : 20				
Penatlity					Penatlity		
				18.4:2 ..			
				Total	WINNER		

POINTS

Decision of Superiority

Judge 1	Judge 2	Judge 3	Judge 4	Judge 5	Judge 6	Judge 7	Referee

Name _____

Signature _____

Lion Cup 2024 Luxembourg

297 Rue de Reckenthal L-2410 Strassen, LUXEMBOURG

Court Nr.	1	Pool	1	Date	2024-06-08	Field Position	59
RED				BLUE			
NOC	GILLES BOSCHMANS (BEL)			NOC	LTHY CORSIN DION (SUI)		
Category	18 - Kata Male U16						
3 Points	2 Points	1 Point	Score	1 Point	2 Points	3 Points	
			21 : 21				
Penatlity				Penatlity			
			21.8:2 ..				
WINNER			Total				

POINTS

Decision of Superiority

Judge 1	Judge 2	Judge 3	Judge 4	Judge 5	Judge 6	Judge 7	Referee

Name _____

Signature _____

Lion Cup 2024 Luxembourg

297 Rue de Reckenthal L-2410 Strassen, LUXEMBOURG

Court Nr.	1	Pool	1	Date	2024-06-08	Field Position	60
RED				BLUE			
NOC	DOS SANTOS SAMUEL (SUI)			NOC	KUNASUTHAN SANTHOSH (FRA)		
Category	18 - Kata Male U16						
3 Points	2 Points	1 Point	Score	1 Point	2 Points	3 Points	
			22 : 22				
Penatlity				Penatlity			
			22.5:2 ..				
WINNER			Total				

POINTS

Decision of Superiority

Judge 1	Judge 2	Judge 3	Judge 4	Judge 5	Judge 6	Judge 7	Referee

Name _____

Signature _____

Lion Cup 2024 Luxembourg

297 Rue de Reckenthal L-2410 Strassen, LUXEMBOURG

Court Nr.	1	Pool	1	Date	2024-06-08	Field Position	61
RED				BLUE			
NOC	NGUYEN THYLANE (FRA)			NOC	FRANCAIS KILLIAN (FRA)		
Category	18 - Kata Male U16						
3 Points	2 Points	1 Point	Score	1 Point	2 Points	3 Points	
			22 : 21				
Penatlity				Penatlity			
			22.6:2 ..				
WINNER			Total				

POINTS

Decision of Superiority

Judge 1	Judge 2	Judge 3	Judge 4	Judge 5	Judge 6	Judge 7	Referee

Name _____

Signature _____

Lion Cup 2024 Luxembourg

297 Rue de Reckenthal L-2410 Strassen, LUXEMBOURG

Court Nr.	1	Pool	1	Date	2024-06-08	Field Position	62
RED				BLUE			
NOC	GILLES BOSCHMANS (BEL)			NOC	DOS SANTOS SAMUEL (SUI)		
Category	18 - Kata Male U16						
3 Points	2 Points	1 Point	Score	1 Point	2 Points	3 Points	
			21 : 20				
Penatlity				Penatlity			
			21.9:2 ..				
WINNER			Total				

POINTS

Decision of Superiority

Judge 1	Judge 2	Judge 3	Judge 4	Judge 5	Judge 6	Judge 7	Referee

Name _____

Signature _____

Lion Cup 2024 Luxembourg

297 Rue de Reckenthal L-2410 Strassen, LUXEMBOURG

Court Nr.	1	Pool	1	Date	2024-06-08	Field Position	63
RED				BLUE			
NOC	NGUYEN THYLANE (FRA)			NOC	GILLES BOSCHMANS (BEL)		
Category	18 - Kata Male U16						
3 Points	2 Points	1 Point	Score	1 Point	2 Points	3 Points	
			22 : 22				
Penatlity				Penatlity			
			22.3:2 ..				
WINNER			Total				

POINTS

Decision of Superiority

Judge 1	Judge 2	Judge 3	Judge 4	Judge 5	Judge 6	Judge 7	Referee

Name _____

Signature _____

Lion Cup 2024 Luxembourg

297 Rue de Reckenthal L-2410 Strassen, LUXEMBOURG

Court Nr.	1	Pool	1	Date	2024-06-08	Field Position	0
RED				BLUE			
NOC	MORRISON LOGAN (SCO)			NOC	FRANCAIS KILLIAN (FRA)		
Category	18 - Kata Male U16						
3 Points	2 Points	1 Point	Score	1 Point	2 Points	3 Points	
			21 : 21				
Penatlity				Penatlity			
			21.2:2 ..				
			Total	WINNER			

POINTS

Decision of Superiority

Judge 1	Judge 2	Judge 3	Judge 4	Judge 5	Judge 6	Judge 7	Referee

Name _____

Signature _____

Lion Cup 2024 Luxembourg

297 Rue de Reckenthal L-2410 Strassen, LUXEMBOURG

Court Nr.	1	Pool	1	Date	2024-06-08	Field Position	2
RED				BLUE			
NOC	MARREDA-LE-MAIGNENT SASHA (BEL)			NOC	MORRISON LOGAN (SCO)		
Category	18 - Kata Male U16						
3 Points	2 Points	1 Point	Score	1 Point	2 Points	3 Points	
			19 : 21				
Penatlity				Penatlity			
			19.9:2 ..				
			Total	WINNER			

POINTS

Decision of Superiority

Judge 1	Judge 2	Judge 3	Judge 4	Judge 5	Judge 6	Judge 7	Referee

Name _____

Signature _____

Lion Cup 2024 Luxembourg

297 Rue de Reckenthal L-2410 Strassen, LUXEMBOURG

Court Nr.	2	Pool	2	Date	2024-06-08	Field Position	0
RED				BLUE			
NOC	LTHY CORSIN DION (SUI)			NOC	DOS SANTOS SAMUEL (SUI)		
Category	18 - Kata Male U16						
3 Points	2 Points	1 Point	Score	1 Point	2 Points	3 Points	
			22 : 21				
Penatlity				Penatlity			
			22.1:2 ..				
WINNER			Total				

POINTS

Decision of Superiority

Judge 1	Judge 2	Judge 3	Judge 4	Judge 5	Judge 6	Judge 7	Referee

Name _____

Signature _____

Lion Cup 2024 Luxembourg

297 Rue de Reckenthal L-2410 Strassen, LUXEMBOURG

Court Nr.	2	Pool	2	Date	2024-06-08	Field Position	2
RED				BLUE			
NOC	SOARES GONALO (LUX)			NOC	LTHY CORSIN DION (SUI)		
Category	18 - Kata Male U16						
3 Points	2 Points	1 Point	Score	1 Point	2 Points	3 Points	
			17 : 21				
Penatlity					Penatlity		
				17.7:2 ..			
				Total	WINNER		

POINTS

Decision of Superiority

Judge 1	Judge 2	Judge 3	Judge 4	Judge 5	Judge 6	Judge 7	Referee

Name _____

Signature _____

Official Results

18 - Kata Male U16			
1	NGUYEN THYLANE		FRA - FRANCE
2	GILLES BOSCHMANS		BEL - BELGIUM
3	FRANCAIS KILLIAN		FRA - FRANCE
3	LÜTHY CORSIN DION		SUI - SWITZERLAND
5	MORRISON LOGAN		SCO - SCOTLAND
5	DOS SANTOS SAMUEL		SUI - SWITZERLAND
7	MARREDA-LE-MAIGNENT SASHA		BEL - BELGIUM
7	SOARES GONÇALO		LUX - LUXEMBOURG

19 - KATA MALE U18

Lion Cup 2024 Luxembourg

ENTRIES BY WEIGHT CATEGORY
19 - Kata Male U18

As of 8 JUN 2024

NOC Code	Gender	Name	Seeding
BEL	M	Anisimov vladislav	
EGY	M	Hegazy Ammar	
EGY	M	Mohamed Salah	
FRA	M	D ONGHIA ENZO	
FRA	M	DEMMERLE Baptiste	
FRA	M	Louis Antonin	
LUX	M	Afonso Marques Leandro	
LUX	M	Arcq Herteleer Alexander	
LUX	M	Borges Joao	
LUX	M	Bruscella Samuele	
NED	M	Bagdja Benaya	
NED	M	van der Heijden Luca	
SUI	M	Bosch David	
SUI	M	Cajöri Milo	
SUI	M	Mischler Kevin	
SUI	M	Ott Simon	
SUI	M	Vogel Kaspar	

19 - Kata Male U18

Lion Cup 2024 Luxembourg, 297 Rue de Reckenthal L-2410 Strassen, LUX

2024-06-07

Tatami
2 17:30

Pool
1 / 1

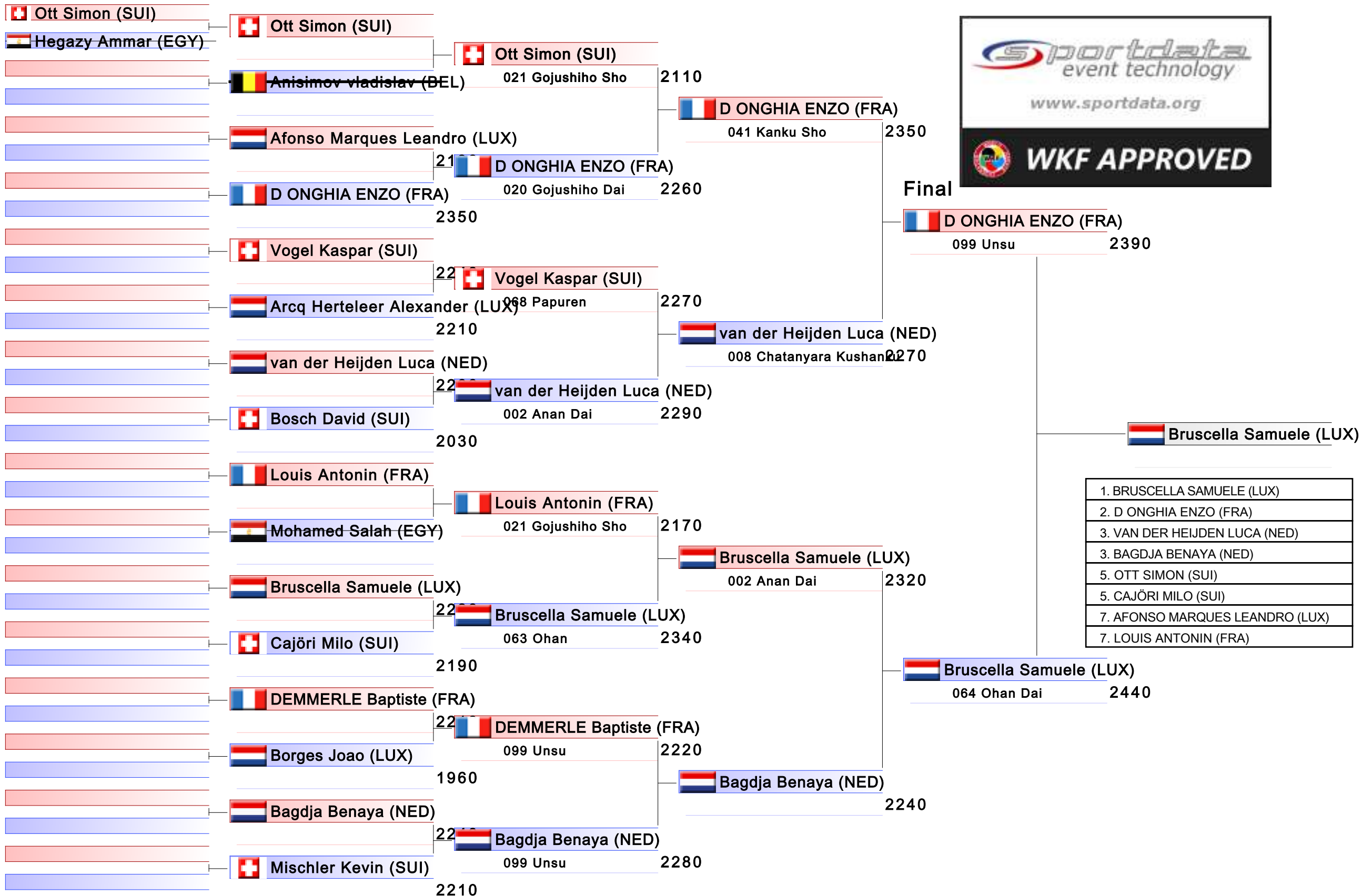

19 - Kata Male U18

Lion Cup 2024 Luxembourg

2024-06-07

Tatami
2 18:45

Pool
1

(c)sportdata GmbH & Co KG 2000-2024 (2024-06-08 18:41) v 10.1.0 build 1 (2024-01-24 23:23 CET) License: Online_Event_ID-7672_LionCup2024Luxembourg (expire 2024-06-21)

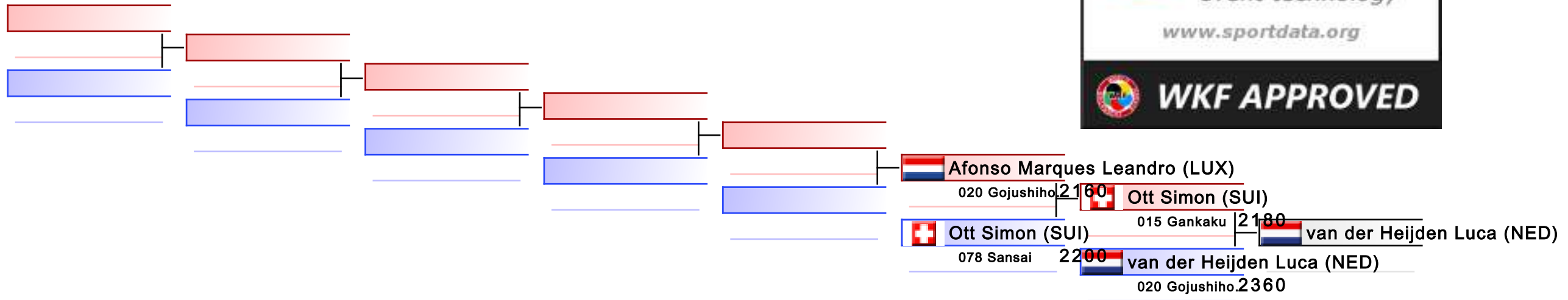

REPECHAGE: (1)

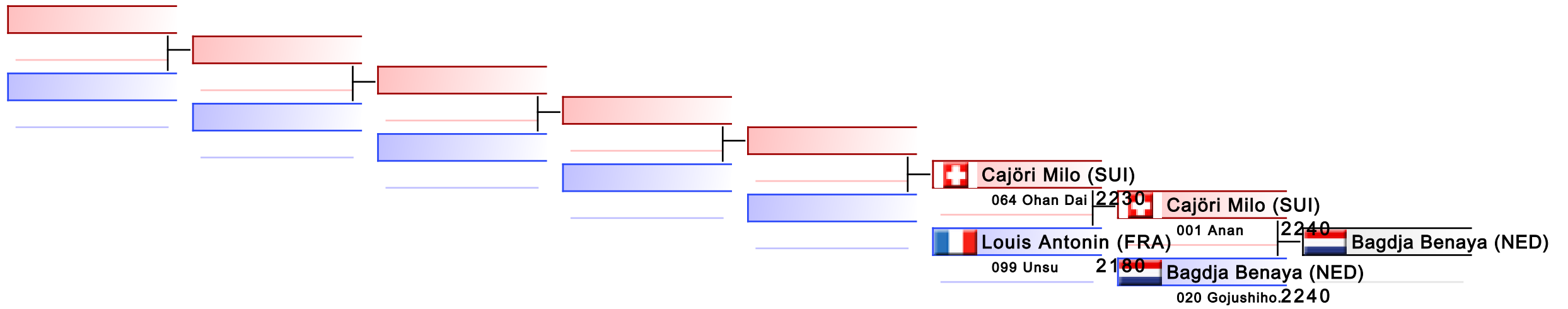

Lion Cup 2024 Luxembourg

297 Rue de Reckenthal L-2410 Strassen, LUXEMBOURG

Court Nr.	1	Pool	1	Date	2024-06-08	Field Position	50
RED				BLUE			
NOC	AFONSO MARQUES LEANDRO (LUX)			NOC	D ONGHIA ENZO (FRA)		
Category	19 - Kata Male U18						
3 Points	2 Points	1 Point	Score	1 Point	2 Points	3 Points	
			21 : 23				
Penatlity				Penatlity			
			21.9:2 ..				
			Total	WINNER			

POINTS

Decision of Superiority

Judge 1	Judge 2	Judge 3	Judge 4	Judge 5	Judge 6	Judge 7	Referee

Name _____

Signature _____

Lion Cup 2024 Luxembourg

297 Rue de Reckenthal L-2410 Strassen, LUXEMBOURG

Court Nr.	1	Pool	1	Date	2024-06-08	Field Position	51
RED				BLUE			
NOC	VOGEL KASPAR (SUI)			NOC	ARCQ HERTELEER ALEXANDER (LUX)		
Category	19 - Kata Male U18						
3 Points	2 Points	1 Point	Score	1 Point	2 Points	3 Points	
			22 : 22				
Penatlity				Penatlity			
			22.4:2 ..				
WINNER			Total				

POINTS

Decision of Superiority

Judge 1	Judge 2	Judge 3	Judge 4	Judge 5	Judge 6	Judge 7	Referee

Name _____

Signature _____

Lion Cup 2024 Luxembourg

297 Rue de Reckenthal L-2410 Strassen, LUXEMBOURG

Court Nr.	1	Pool	1	Date	2024-06-08	Field Position	52
RED				BLUE			
NOC	VAN DER HEIJDEN LUCA (NED)			NOC	BOSCH DAVID (SUI)		
Category	19 - Kata Male U18						
3 Points	2 Points	1 Point	Score	1 Point	2 Points	3 Points	
			22 : 20				
Penatlity				Penatlity			
			22.0:2 ..				
WINNER			Total				

POINTS

Decision of Superiority

Judge 1	Judge 2	Judge 3	Judge 4	Judge 5	Judge 6	Judge 7	Referee

Name _____

Signature _____

Lion Cup 2024 Luxembourg

297 Rue de Reckenthal L-2410 Strassen, LUXEMBOURG

Court Nr.	1	Pool	1	Date	2024-06-08	Field Position	54
RED				BLUE			
NOC	BRUSCELLA SAMUELE (LUX)			NOC	CAJRI MILO (SUI)		
Category	19 - Kata Male U18						
3 Points	2 Points	1 Point	Score	1 Point	2 Points	3 Points	
			22 : 21				
Penatlity				Penatlity			
			22.8:2 ..				
WINNER			Total				

POINTS

Decision of Superiority

Judge 1	Judge 2	Judge 3	Judge 4	Judge 5	Judge 6	Judge 7	Referee

Name _____

Signature _____

Lion Cup 2024 Luxembourg

297 Rue de Reckenthal L-2410 Strassen, LUXEMBOURG

Court Nr.	1	Pool	1	Date	2024-06-08	Field Position	55
RED				BLUE			
NOC	DEMNERLE BAPTISTE (FRA)			NOC	BORGES JOAO (LUX)		
Category	19 - Kata Male U18						
3 Points	2 Points	1 Point	Score	1 Point	2 Points	3 Points	
			22 : 19				
Penatlity				Penatlity			
			22.1:1 ..				
WINNER			Total				

POINTS

Decision of Superiority

Judge 1	Judge 2	Judge 3	Judge 4	Judge 5	Judge 6	Judge 7	Referee

Name _____

Signature _____

Lion Cup 2024 Luxembourg

297 Rue de Reckenthal L-2410 Strassen, LUXEMBOURG

Court Nr.	1	Pool	1	Date	2024-06-08	Field Position	56
RED				BLUE			
NOC	BAGDJA BENAYA (NED)			NOC	MISCHLER KEVIN (SUI)		
Category	19 - Kata Male U18						
3 Points	2 Points	1 Point	Score	1 Point	2 Points	3 Points	
			22 : 22				
Penatlity				Penatlity			
			22.4:2 ..				
WINNER			Total				

POINTS

Decision of Superiority

Judge 1	Judge 2	Judge 3	Judge 4	Judge 5	Judge 6	Judge 7	Referee

Name _____

Signature _____

Lion Cup 2024 Luxembourg

297 Rue de Reckenthal L-2410 Strassen, LUXEMBOURG

Court Nr.	1	Pool	1	Date	2024-06-08	Field Position	57
RED				BLUE			
NOC	OTT SIMON (SUI)			NOC	D ONGHIA ENZO (FRA)		
Category	19 - Kata Male U18						
3 Points	2 Points	1 Point	Score	1 Point	2 Points	3 Points	
			21 : 22				
Penatlity				Penatlity			
			21.1:2 ..				
			Total	WINNER			

POINTS

Decision of Superiority

Judge 1	Judge 2	Judge 3	Judge 4	Judge 5	Judge 6	Judge 7	Referee

Name _____

Signature _____

Lion Cup 2024 Luxembourg

297 Rue de Reckenthal L-2410 Strassen, LUXEMBOURG

Court Nr.	1	Pool	1	Date	2024-06-08	Field Position	58
RED				BLUE			
NOC	VOGEL KASPAR (SUI)			NOC	VAN DER HEIJDEN LUCA (NED)		
Category	19 - Kata Male U18						
3 Points	2 Points	1 Point	Score	1 Point	2 Points	3 Points	
			22 : 22				
Penatlity				Penatlity			
			22.7:2 ..				
			Total	WINNER			

POINTS

Decision of Superiority

Judge 1	Judge 2	Judge 3	Judge 4	Judge 5	Judge 6	Judge 7	Referee

Name _____

Signature _____

Lion Cup 2024 Luxembourg

297 Rue de Reckenthal L-2410 Strassen, LUXEMBOURG

Court Nr.	1	Pool	1	Date	2024-06-08	Field Position	59
RED				BLUE			
NOC	LOUIS ANTONIN (FRA)			NOC	BRUSCELLA SAMUELE (LUX)		
Category	19 - Kata Male U18						
3 Points	2 Points	1 Point	Score	1 Point	2 Points	3 Points	
			21 : 23				
Penatlity				Penatlity			
			21.7:2 ..				
			Total	WINNER			

POINTS

Decision of Superiority

Judge 1	Judge 2	Judge 3	Judge 4	Judge 5	Judge 6	Judge 7	Referee

Name _____

Signature _____

Lion Cup 2024 Luxembourg

297 Rue de Reckenthal L-2410 Strassen, LUXEMBOURG

Court Nr.	1	Pool	1	Date	2024-06-08	Field Position	60
RED				BLUE			
NOC	DEMMERLE BAPTISTE (FRA)			NOC	BAGDJA BENAYA (NED)		
Category	19 - Kata Male U18						
3 Points	2 Points	1 Point	Score	1 Point	2 Points	3 Points	
			22 : 22				
Penatlity				Penatlity			
			22.2:2 ..				
			Total	WINNER			

POINTS

Decision of Superiority

Judge 1	Judge 2	Judge 3	Judge 4	Judge 5	Judge 6	Judge 7	Referee

Name _____

Signature _____

Lion Cup 2024 Luxembourg

297 Rue de Reckenthal L-2410 Strassen, LUXEMBOURG

Court Nr.	1	Pool	1	Date	2024-06-08	Field Position	61
RED				BLUE			
NOC	D ONGHIA ENZO (FRA)			NOC	VAN DER HEIJDEN LUCA (NED)		
Category	19 - Kata Male U18						
3 Points	2 Points	1 Point	Score	1 Point	2 Points	3 Points	
			23 : 22				
Penatlity				Penatlity			
			23.5:2 ..				
WINNER			Total				

POINTS

Decision of Superiority

Judge 1	Judge 2	Judge 3	Judge 4	Judge 5	Judge 6	Judge 7	Referee

Name _____

Signature _____

Lion Cup 2024 Luxembourg

297 Rue de Reckenthal L-2410 Strassen, LUXEMBOURG

Court Nr.	1	Pool	1	Date	2024-06-08	Field Position	62
RED				BLUE			
NOC	BRUSCELLA SAMUELE (LUX)			NOC	BAGDJA BENAYA (NED)		
Category	19 - Kata Male U18						
3 Points	2 Points	1 Point	Score	1 Point	2 Points	3 Points	
			23 : 22				
Penatlity				Penatlity			
			23.2:2 ..				
WINNER			Total				

POINTS

Decision of Superiority

Judge 1	Judge 2	Judge 3	Judge 4	Judge 5	Judge 6	Judge 7	Referee

Name _____

Signature _____

Lion Cup 2024 Luxembourg

297 Rue de Reckenthal L-2410 Strassen, LUXEMBOURG

Court Nr.	1	Pool	1	Date	2024-06-08	Field Position	63
RED				BLUE			
NOC	D ONGHIA ENZO (FRA)			NOC	BRUSCELLA SAMUELE (LUX)		
Category	19 - Kata Male U18						
3 Points	2 Points	1 Point	Score	1 Point	2 Points	3 Points	
			23 : 24				
Penatlity				Penatlity			
			23.9:2 ..				
			Total	WINNER			

POINTS

Decision of Superiority

Judge 1	Judge 2	Judge 3	Judge 4	Judge 5	Judge 6	Judge 7	Referee

Name _____

Signature _____

Lion Cup 2024 Luxembourg

297 Rue de Reckenthal L-2410 Strassen, LUXEMBOURG

Court Nr.	1	Pool	1	Date	2024-06-08	Field Position	0
RED				BLUE			
NOC	OTT SIMON (SUI)			NOC	VAN DER HEIJDEN LUCA (NED)		
Category	19 - Kata Male U18						
3 Points	2 Points	1 Point	Score	1 Point	2 Points	3 Points	
			21 : 23				
Penatlity				Penatlity			
			21.8:2 ..				
			Total	WINNER			

POINTS

Decision of Superiority

Judge 1	Judge 2	Judge 3	Judge 4	Judge 5	Judge 6	Judge 7	Referee

Name _____

Signature _____

Lion Cup 2024 Luxembourg

297 Rue de Reckenthal L-2410 Strassen, LUXEMBOURG

Court Nr.	1	Pool	1	Date	2024-06-08	Field Position	2
RED				BLUE			
NOC	AFONSO MARQUES LEANDRO (LUX)			NOC	OTT SIMON (SUI)		
Category	19 - Kata Male U18						
3 Points	2 Points	1 Point	Score	1 Point	2 Points	3 Points	
			21 : 22				
Penatlity					Penatlity		
				21.6:2 ..			
				Total	WINNER		

POINTS

Decision of Superiority

Judge 1	Judge 2	Judge 3	Judge 4	Judge 5	Judge 6	Judge 7	Referee

Name _____

Signature _____

Lion Cup 2024 Luxembourg

297 Rue de Reckenthal L-2410 Strassen, LUXEMBOURG

Court Nr.	2	Pool	2	Date	2024-06-08	Field Position	0
RED				BLUE			
NOC	CAJRI MILO (SUI)			NOC	BAGDJA BENAYA (NED)		
Category	19 - Kata Male U18						
3 Points	2 Points	1 Point	Score	1 Point	2 Points	3 Points	
			22 : 22				
Penatlity				Penatlity			
			22.4:2 ..				
WINNER			Total				

POINTS

Decision of Superiority

Judge 1	Judge 2	Judge 3	Judge 4	Judge 5	Judge 6	Judge 7	Referee

Name _____

Signature _____

Lion Cup 2024 Luxembourg

297 Rue de Reckenthal L-2410 Strassen, LUXEMBOURG

Court Nr.	2	Pool	2	Date	2024-06-08	Field Position	2
RED				BLUE			
NOC	CAJRI MILO (SUI)			NOC	LOUIS ANTONIN (FRA)		
Category	19 - Kata Male U18						
3 Points	2 Points	1 Point	Score	1 Point	2 Points	3 Points	
			22 : 21				
Penatlity				Penatlity			
			22.3:2 ..				
WINNER			Total				

POINTS

Decision of Superiority

Judge 1	Judge 2	Judge 3	Judge 4	Judge 5	Judge 6	Judge 7	Referee

Name _____

Signature _____

Official Results

19 - Kata Male U18			
1	BRUSCELLA SAMUELE		LUX - LUXEMBOURG
2	D ONGHIA ENZO		FRA - FRANCE
3	VAN DER HEIJDEN LUCA		NED - NETHERLANDS
3	BAGDJA BENAYA		NED - NETHERLANDS
5	OTT SIMON		SUI - SWITZERLAND
5	CAJÖRI MILO		SUI - SWITZERLAND
7	AFONSO MARQUES LEANDRO		LUX - LUXEMBOURG
7	LOUIS ANTONIN		FRA - FRANCE

20 - KATA MALE U21

Lion Cup 2024 Luxembourg

ENTRIES BY WEIGHT CATEGORY
20 - Kata Male U21

As of 8 JUN 2024

NOC Code	Gender	Name	Seeding
FRA	M	GREGOIRE Liam	
LUX	M	Chaffort Lucas	
SUI	M	SCHEDDEL Keni	
SUI	M	Schertenleib Lars	

20 - Kata Male U21

Lion Cup 2024 Luxembourg, 297 Rue de Reckenthal L-2410 Strassen, LUX

2024-06-07

Tatami
5 18:30

Pool
1/1

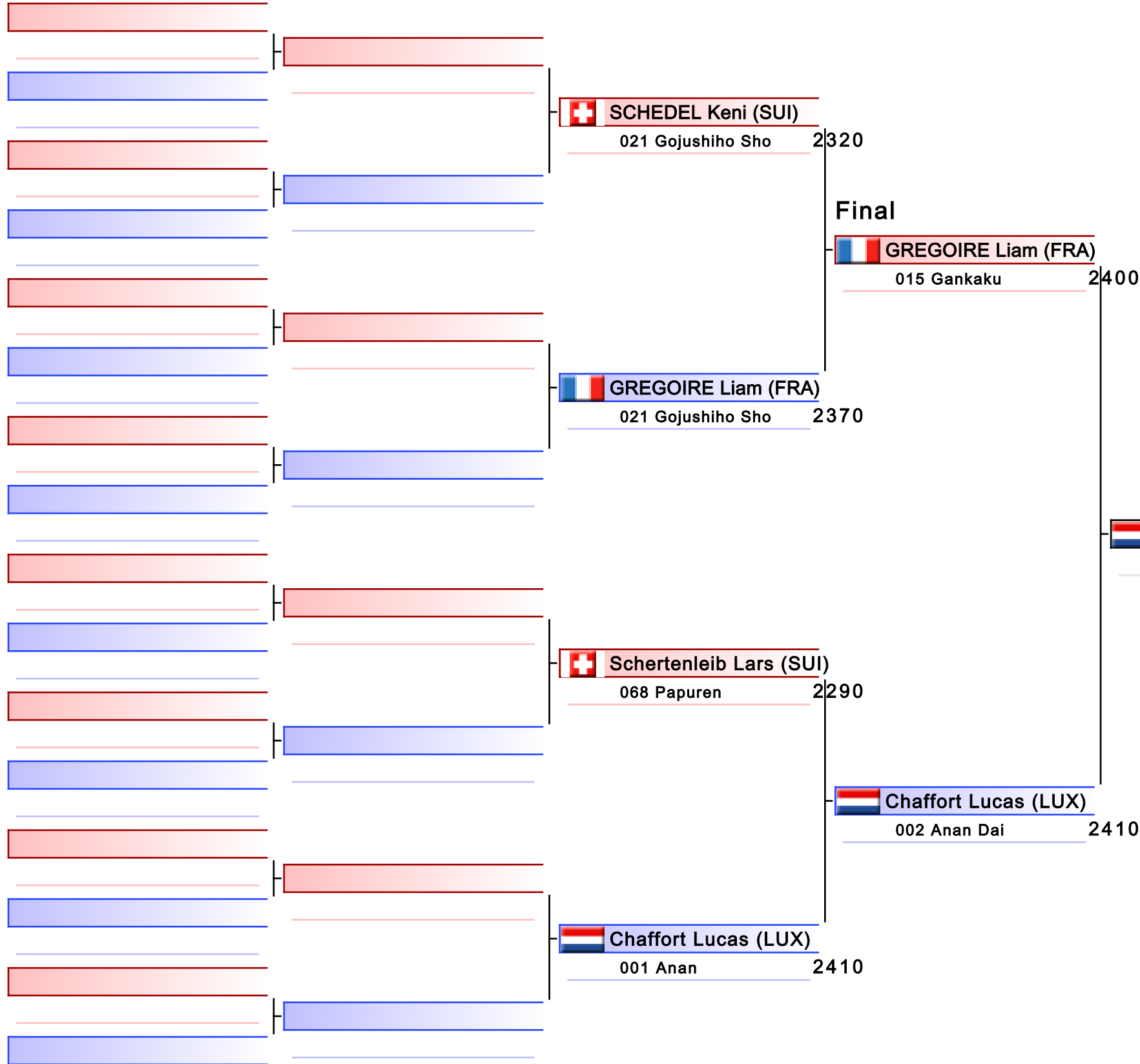

1. CHAFFORT LUCAS (LUX)
2. GREGOIRE LIAM (FRA)
3. SCHEDEL KENI (SUI)
3. SCHERTENLEIB LARS (SUI)

20 - Kata Male U21

Lion Cup 2024 Luxembourg

Tatami

Pool

1

(c)sportdata GmbH & Co KG 2000-2024 (2024-06-08 18:41) v 10.1.0 build 1 (2024-01-24 23:23 CET) License: Online_Event_ID-7672_LionCup2024Luxembourg (expire 2024-06-21)

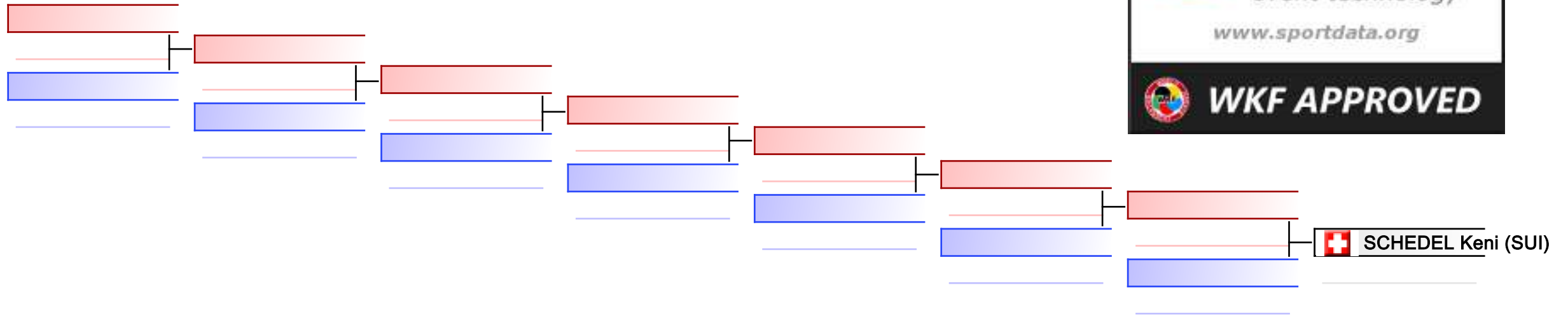

REPECHAGE: (1)

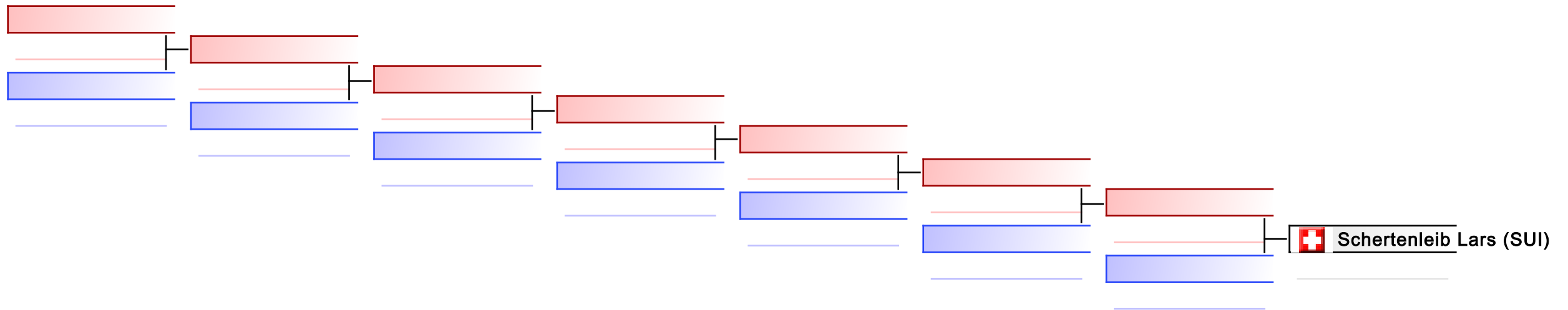

Lion Cup 2024 Luxembourg

297 Rue de Reckenthal L-2410 Strassen, LUXEMBOURG

Court Nr.	1	Pool	1	Date	2024-06-08	Field Position	61
RED				BLUE			
NOC	SCHEDEL KENI (SUI)			NOC	GREGOIRE LIAM (FRA)		
Category	20 - Kata Male U21						
3 Points	2 Points	1 Point	Score	1 Point	2 Points	3 Points	
			:				
Penatlity				Penatlity			
			Total				

Decision of Superiority

Judge 1	Judge 2	Judge 3	Judge 4	Judge 5	Judge 6	Judge 7	Referee

Name _____

Signature _____

Lion Cup 2024 Luxembourg

297 Rue de Reckenthal L-2410 Strassen, LUXEMBOURG

Court Nr.	1	Pool	1	Date	2024-06-08	Field Position	62
RED				BLUE			
NOC	SCHERTENLEIB LARS (SUI)			NOC	CHAFFORT LUCAS (LUX)		
Category	20 - Kata Male U21						
3 Points	2 Points	1 Point	Score	1 Point	2 Points	3 Points	
			:				
Penatlity				Penatlity			
			Total				

Decision of Superiority

Judge 1	Judge 2	Judge 3	Judge 4	Judge 5	Judge 6	Judge 7	Referee

Name _____

Signature _____

Lion Cup 2024 Luxembourg

297 Rue de Reckenthal L-2410 Strassen, LUXEMBOURG

Court Nr.	1	Pool	1	Date	2024-06-08	Field Position	63
RED				BLUE			
NOC	GREGOIRE LIAM (FRA)			NOC	CHAFFORT LUCAS (LUX)		
Category	20 - Kata Male U21						
3 Points	2 Points	1 Point	Score	1 Point	2 Points	3 Points	
			:				
Penatlity				Penatlity			
			Total				

Decision of Superiority





Judge 1	Judge 2	Judge 3	Judge 4	Judge 5	Judge 6	Judge 7	Referee

Name _____

Signature _____

Lion Cup 2024 Luxembourg - 2024-06-07

Official Results

20 - Kata Male U21			
1	CHAFFORT LUCAS		LUX - LUXEMBOURG
2	GREGOIRE LIAM		FRA - FRANCE
3	SCHEDER KENI		SUI - SWITZERLAND
3	SCHERTENLEIB LARS		SUI - SWITZERLAND

22 - KATA MALE SENIOR

Lion Cup 2024 Luxembourg

ENTRIES BY WEIGHT CATEGORY
22 - Kata Male Senior

As of 8 JUN 2024

NOC Code	Gender	Name	Seeding
EGY	M	Rashed Mohamed	
FRA	M	ALMEIDA DA SILVA Alexandre	
FRA	M	ASSEMAT REMI	
FRA	M	BUISSON Mattéo	
FRA	M	D ONGHIA ENZO	
FRA	M	DUCHAIINE GREGOIRE	
FRA	M	GREGOIRE Liam	
FRA	M	Louis Antonin	
FRA	M	Noel Arthur	
FRA	M	STASSIAUX MAHEL	
LUX	M	Afonso Marques Leandro	
LUX	M	Arcq Herteleer Alexander	
LUX	M	Bruscella Samuele	
LUX	M	Chaffort Lucas	
LUX	M	Petry Kevin	
LUX	M	Vilm Jérôme	
NED	M	van der Heijden Luca	
SUI	M	Mischler Kevin	
SUI	M	Ott Simon	
SUI	M	SCHEDDEL Keni	
SUI	M	Schertenleib Lars	

22 - Kata Male Senior

Lion Cup 2024 Luxembourg, 297 Rue de Reckenthal L-2410 Strassen, LUX

2024-06-07

Tatami
3 19:00

Pool
1/2

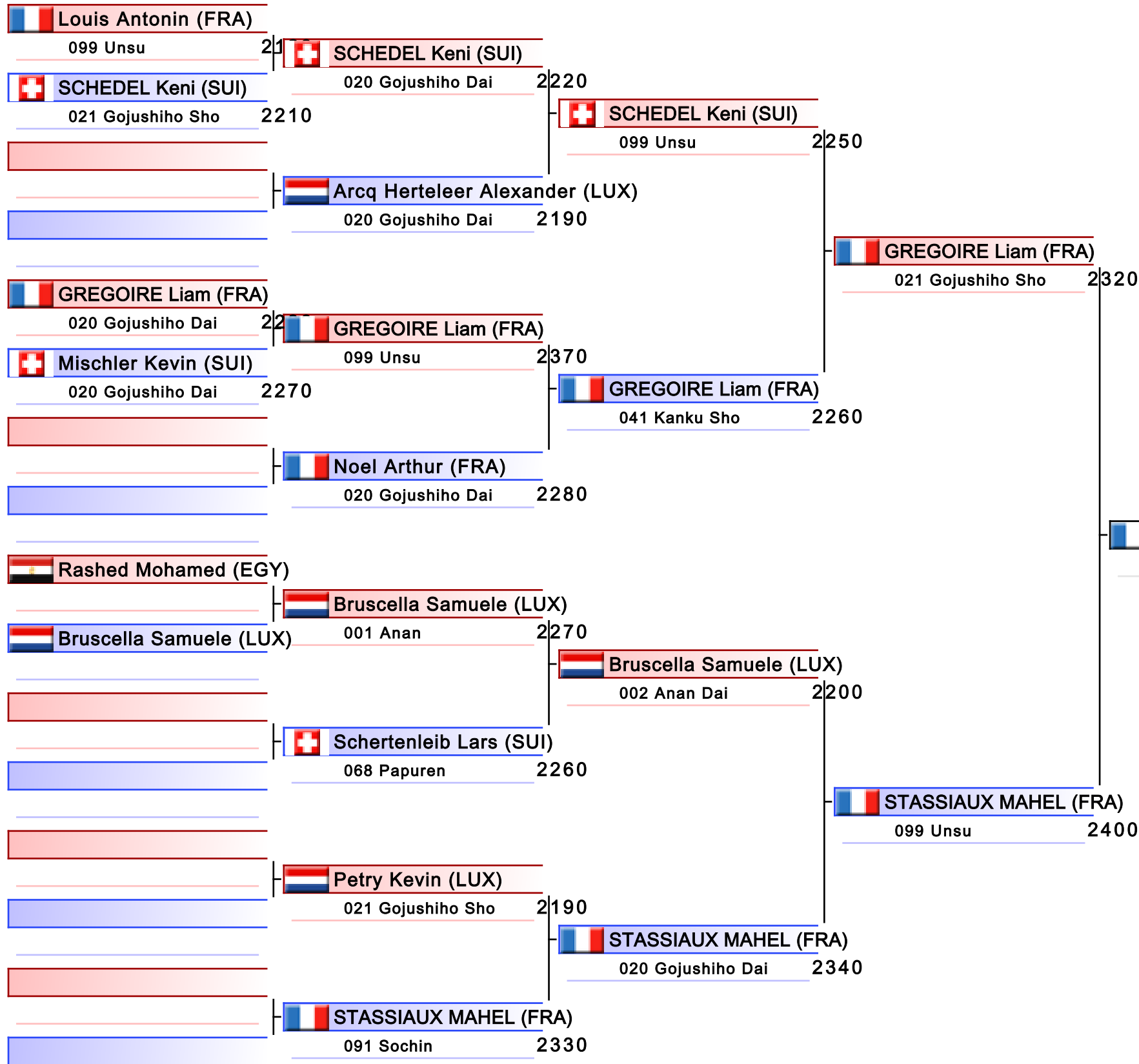

1. STASSIAUX MAHEL (FRA)
2. DUCHAINE GREGOIRE (FRA)
3. GREGOIRE LIAM (FRA)
3. CHAFFORT LUCAS (LUX)
5. BRUSCELLA SAMUELE (LUX)
5. D ONGHIA ENZO (FRA)
7. PETRY KEVIN (LUX)
7. AFONSO MARQUES LEANDRO (LUX)

22 - Kata Male Senior

Lion Cup 2024 Luxembourg, 297 Rue de Reckenthal L-2410 Strassen, LUX

2024-06-07

Tatami 4 19:15

Pool 2/2

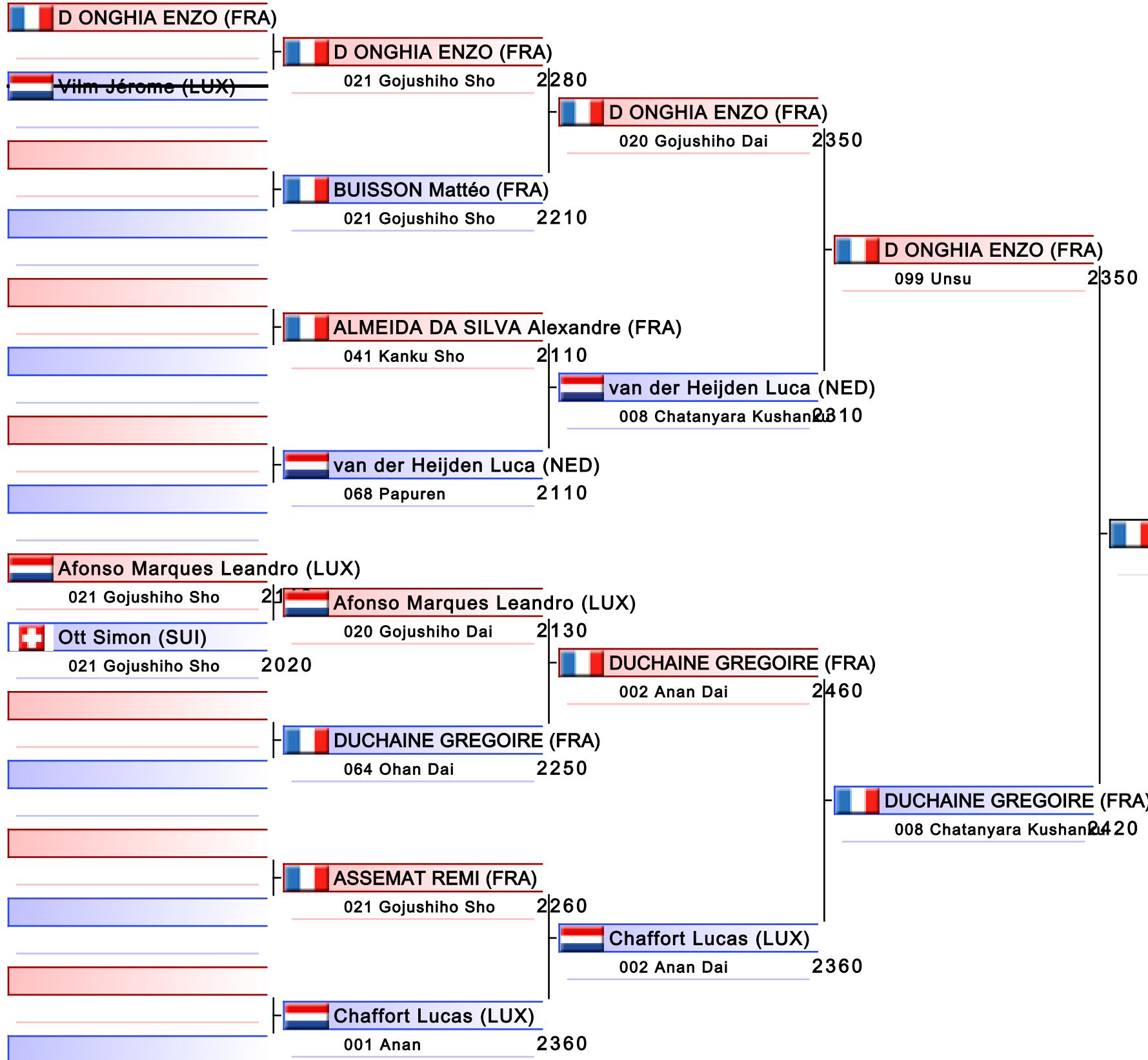

1. STASSIAUX MAHEL (FRA)
2. DUCHAINE GREGOIRE (FRA)
3. GREGOIRE LIAM (FRA)
3. CHAFFORT LUCAS (LUX)
5. BRUSCELLA SAMUELE (LUX)
5. D ONGHIA ENZO (FRA)
7. PETRY KEVIN (LUX)
7. AFONSO MARQUES LEANDRO (LUX)

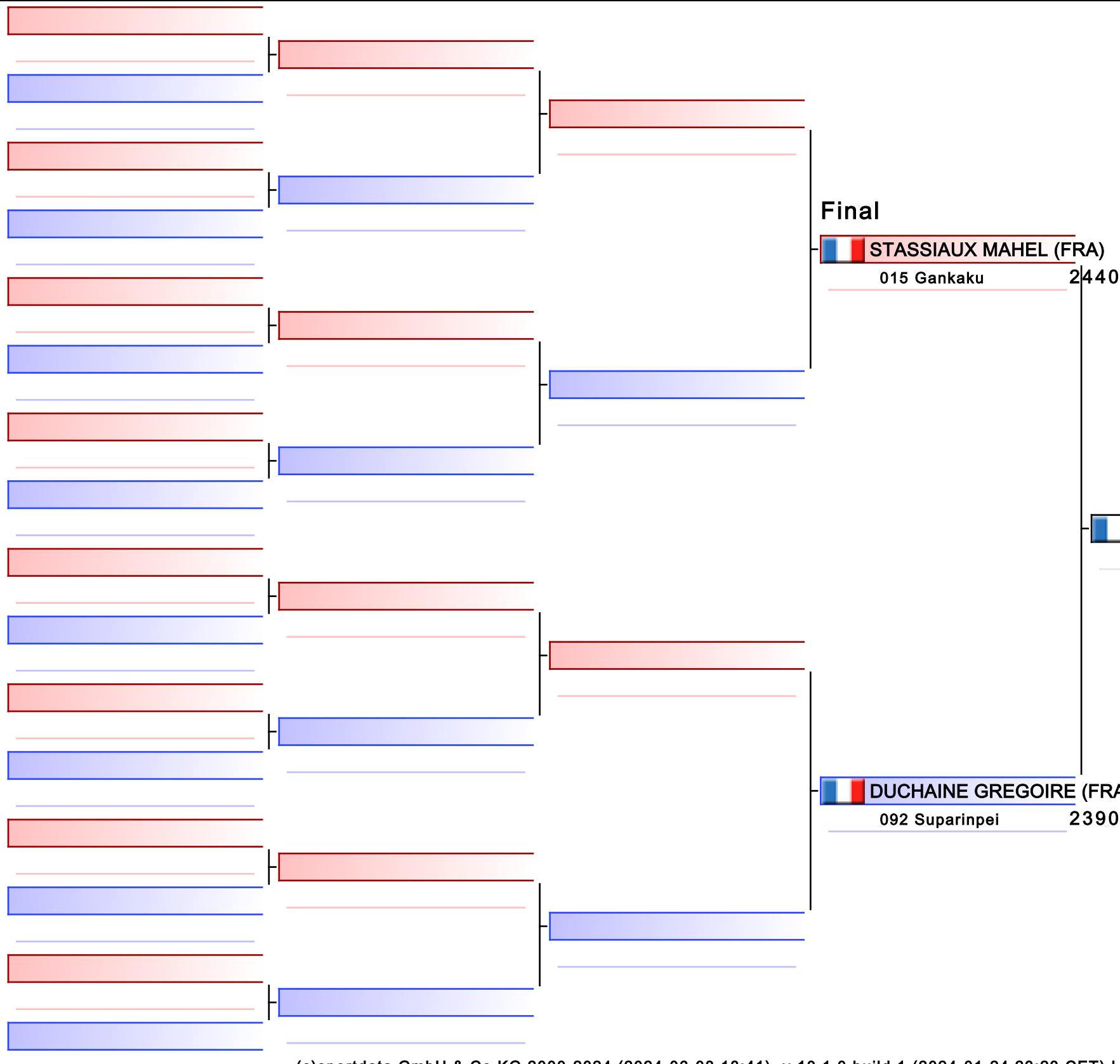

Final

STASSIAUX MAHEL (FRA)
 015 Gankaku 2440

STASSIAUX MAHEL (FRA)

DUCHAINE GREGOIRE (FRA)
 092 Suparinpei 2390

1. STASSIAUX MAHEL (FRA)
2. DUCHAINE GREGOIRE (FRA)
3. GREGOIRE LIAM (FRA)
3. CHAFFORT LUCAS (LUX)
5. BRUSCELLA SAMUELE (LUX)
5. D ONGHIA ENZO (FRA)
7. PETRY KEVIN (LUX)
7. AFONSO MARQUES LEANDRO (LUX)

22 - Kata Male Senior

Lion Cup 2024 Luxembourg

2024-06-07

Tatami 3 19:50

Pool 1

(c)sportdata GmbH & Co KG 2000-2024 (2024-06-08 18:41) v 10.1.0 build 1 (2024-01-24 23:23 CET) License: Online_Event_ID-7672_LionCup2024Luxembourg (expire 2024-06-21)

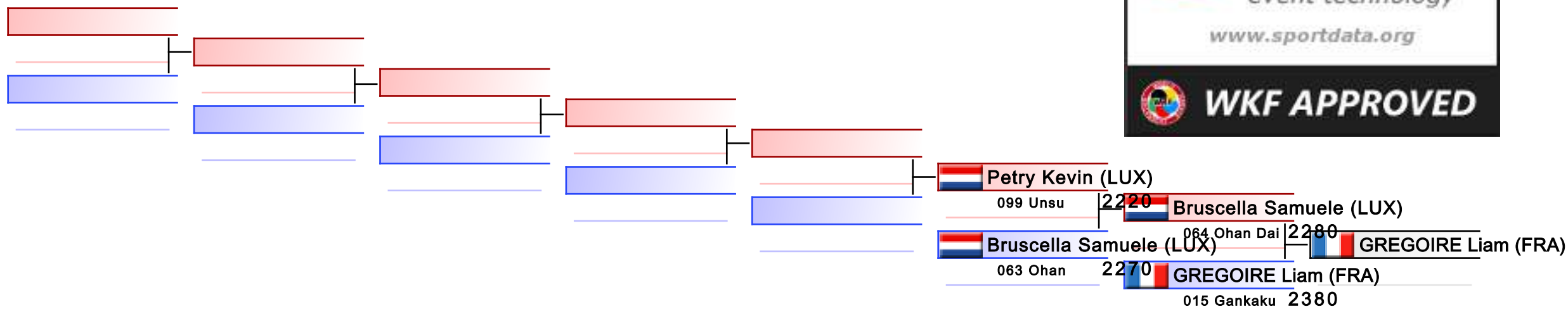

REPECHAGE: (1)

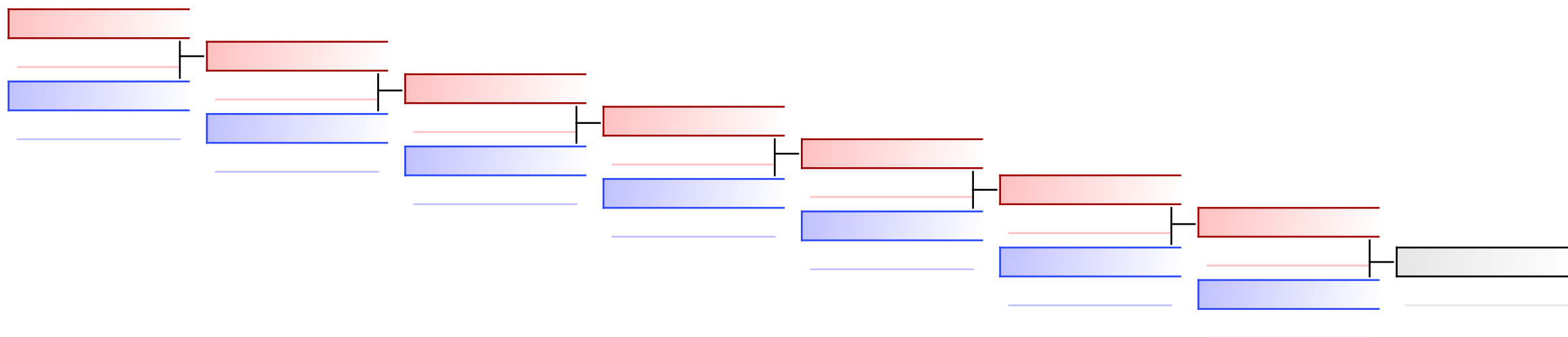

22 - Kata Male Senior

Lion Cup 2024 Luxembourg

2024-06-07

Tatami
4 19:55

Pool
2

(c)sportdata GmbH & Co KG 2000-2024 (2024-06-08 18:41) v 10.1.0 build 1 (2024-01-24 23:23 CET) License: Online_Event_ID-7672_LionCup2024Luxembourg (expire 2024-06-21)

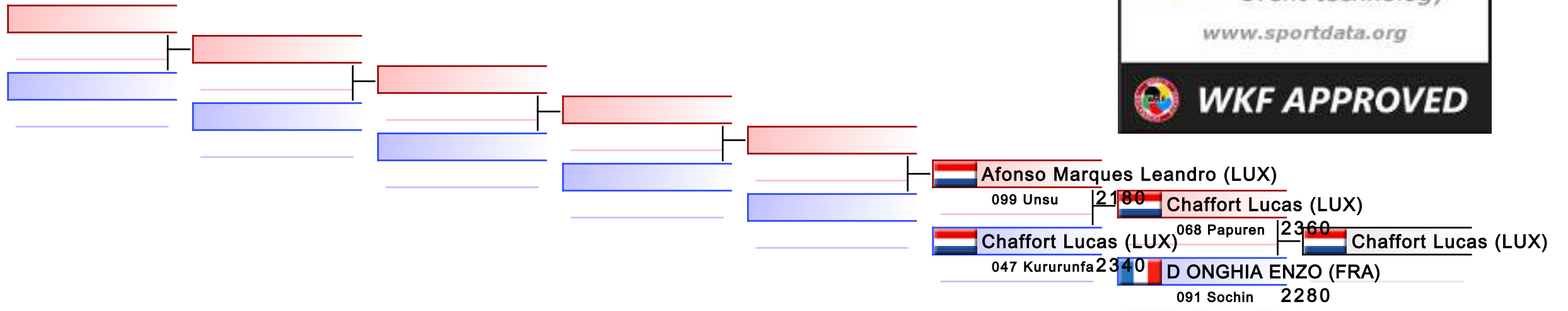

REPECHAGE: (2)

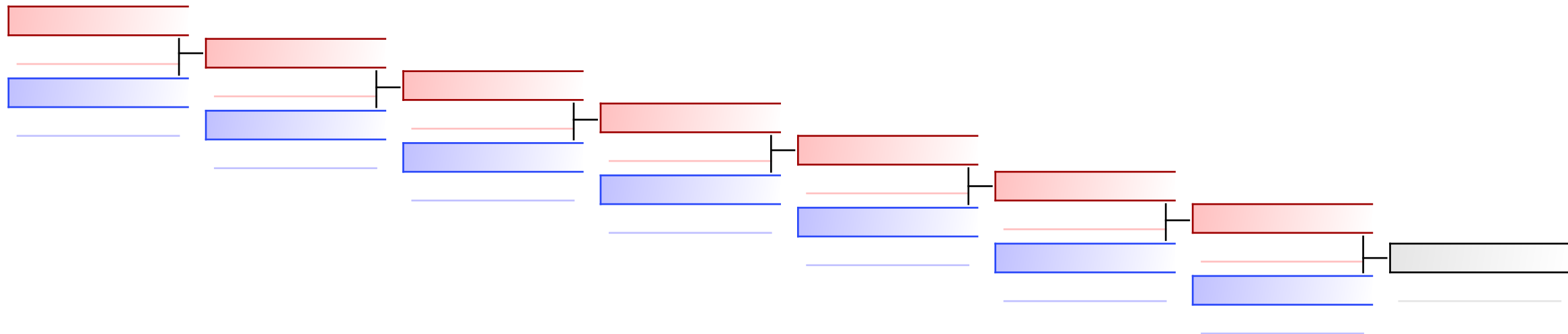

Lion Cup 2024 Luxembourg

297 Rue de Reckenthal L-2410 Strassen, LUXEMBOURG

Court Nr.	1	Pool	1	Date	2024-06-08	Field Position	49
RED				BLUE			
NOC	LOUIS ANTONIN (FRA)			NOC	SCHEDEL KENI (SUI)		
Category	22 - Kata Male Senior						
3 Points	2 Points	1 Point	Score	1 Point	2 Points	3 Points	
			21 : 22				
Penatlity				Penatlity			
			21.2:2 ..				
			Total	WINNER			

POINTS

Decision of Superiority

Judge 1	Judge 2	Judge 3	Judge 4	Judge 5	Judge 6	Judge 7	Referee

Name _____

Signature _____

Lion Cup 2024 Luxembourg

297 Rue de Reckenthal L-2410 Strassen, LUXEMBOURG

Court Nr.	1	Pool	1	Date	2024-06-08	Field Position	51
RED				BLUE			
NOC	GREGOIRE LIAM (FRA)			NOC	MISCHLER KEVIN (SUI)		
Category	22 - Kata Male Senior						
3 Points	2 Points	1 Point	Score	1 Point	2 Points	3 Points	
			22 : 22				
Penatlity				Penatlity			
			22.8:2 ..				
WINNER			Total				

POINTS

Decision of Superiority

Judge 1	Judge 2	Judge 3	Judge 4	Judge 5	Judge 6	Judge 7	Referee

Name _____

Signature _____

Lion Cup 2024 Luxembourg

297 Rue de Reckenthal L-2410 Strassen, LUXEMBOURG

Court Nr.	1	Pool	1	Date	2024-06-08	Field Position	53
RED				BLUE			
NOC	RASHED MOHAMED (EGY)			NOC	BRUSCELLA SAMUELE (LUX)		
Category	22 - Kata Male Senior						
3 Points	2 Points	1 Point	Score	1 Point	2 Points	3 Points	
			:				
Penatlity				Penatlity			
			Total				

Decision of Superiority

Judge 1	Judge 2	Judge 3	Judge 4	Judge 5	Judge 6	Judge 7	Referee

Name _____

Signature _____

Lion Cup 2024 Luxembourg

297 Rue de Reckenthal L-2410 Strassen, LUXEMBOURG

Court Nr.	1	Pool	1	Date	2024-06-08	Field Position	57
RED				BLUE			
NOC	SCHEDEL KENI (SUI)			NOC	ARCQ HERTELEER ALEXANDER (LUX)		
Category	22 - Kata Male Senior						
3 Points	2 Points	1 Point	Score	1 Point	2 Points	3 Points	
			22 : 21				
Penatlity				Penatlity			
			22.2:2 ..				
WINNER			Total				

POINTS

Decision of Superiority

Judge 1	Judge 2	Judge 3	Judge 4	Judge 5	Judge 6	Judge 7	Referee

Name _____

Signature _____

Lion Cup 2024 Luxembourg

297 Rue de Reckenthal L-2410 Strassen, LUXEMBOURG

Court Nr.	1	Pool	1	Date	2024-06-08	Field Position	58
RED				BLUE			
NOC	GREGOIRE LIAM (FRA)			NOC	NOEL ARTHUR (FRA)		
Category	22 - Kata Male Senior						
3 Points	2 Points	1 Point	Score	1 Point	2 Points	3 Points	
			23 : 22				
Penatlity				Penatlity			
			23.7:2 ..				
WINNER			Total				

POINTS

Decision of Superiority

Judge 1	Judge 2	Judge 3	Judge 4	Judge 5	Judge 6	Judge 7	Referee

Name _____

Signature _____

Lion Cup 2024 Luxembourg

297 Rue de Reckenthal L-2410 Strassen, LUXEMBOURG

Court Nr.	1	Pool	1	Date	2024-06-08	Field Position	59
RED				BLUE			
NOC	BRUSCELLA SAMUELE (LUX)			NOC	SCHERTENLEIB LARS (SUI)		
Category	22 - Kata Male Senior						
3 Points	2 Points	1 Point	Score	1 Point	2 Points	3 Points	
			22 : 22				
Penatlity				Penatlity			
			22.7:2 ..				
WINNER			Total				

POINTS

Decision of Superiority

Judge 1	Judge 2	Judge 3	Judge 4	Judge 5	Judge 6	Judge 7	Referee

Name _____

Signature _____

Lion Cup 2024 Luxembourg

297 Rue de Reckenthal L-2410 Strassen, LUXEMBOURG

Court Nr.	1	Pool	1	Date	2024-06-08	Field Position	60
RED				BLUE			
NOC	PETRY KEVIN (LUX)			NOC	STASSIAUX MAHEL (FRA)		
Category	22 - Kata Male Senior						
3 Points	2 Points	1 Point	Score	1 Point	2 Points	3 Points	
			21 : 23				
Penatlity				Penatlity			
			21.9:2 ..				
			Total	WINNER			

POINTS

Decision of Superiority

Judge 1	Judge 2	Judge 3	Judge 4	Judge 5	Judge 6	Judge 7	Referee

Name _____

Signature _____

Lion Cup 2024 Luxembourg

297 Rue de Reckenthal L-2410 Strassen, LUXEMBOURG

Court Nr.	1	Pool	1	Date	2024-06-08	Field Position	61
RED				BLUE			
NOC	SCHEDEL KENI (SUI)			NOC	GREGOIRE LIAM (FRA)		
Category	22 - Kata Male Senior						
3 Points	2 Points	1 Point	Score	1 Point	2 Points	3 Points	
			22 : 22				
Penatlity				Penatlity			
			22.5:2 ..				
			Total	WINNER			

POINTS

Decision of Superiority

Judge 1	Judge 2	Judge 3	Judge 4	Judge 5	Judge 6	Judge 7	Referee

Name _____

Signature _____

Lion Cup 2024 Luxembourg

297 Rue de Reckenthal L-2410 Strassen, LUXEMBOURG

Court Nr.	1	Pool	1	Date	2024-06-08	Field Position	62
RED				BLUE			
NOC	BRUSCELLA SAMUELE (LUX)			NOC	STASSIAUX MAHEL (FRA)		
Category	22 - Kata Male Senior						
3 Points	2 Points	1 Point	Score	1 Point	2 Points	3 Points	
			22 : 23				
Penatlity				Penatlity			
			22.0:2 ..				
			Total	WINNER			

POINTS

Decision of Superiority

Judge 1	Judge 2	Judge 3	Judge 4	Judge 5	Judge 6	Judge 7	Referee

Name _____

Signature _____

Lion Cup 2024 Luxembourg

297 Rue de Reckenthal L-2410 Strassen, LUXEMBOURG

Court Nr.	1	Pool	1	Date	2024-06-08	Field Position	63
RED				BLUE			
NOC	GREGOIRE LIAM (FRA)			NOC	STASSIAUX MAHEL (FRA)		
Category	22 - Kata Male Senior						
3 Points	2 Points	1 Point	Score	1 Point	2 Points	3 Points	
			23 : 24				
Penatlity				Penatlity			
			23.2:2 ..				
			Total	WINNER			

POINTS

Decision of Superiority

Judge 1	Judge 2	Judge 3	Judge 4	Judge 5	Judge 6	Judge 7	Referee

Name _____

Signature _____

Lion Cup 2024 Luxembourg

297 Rue de Reckenthal L-2410 Strassen, LUXEMBOURG

Court Nr.	2	Pool	2	Date	2024-06-08	Field Position	53
RED				BLUE			
NOC	AFONSO MARQUES LEANDRO (LUX)			NOC	OTT SIMON (SUI)		
Category	22 - Kata Male Senior						
3 Points	2 Points	1 Point	Score	1 Point	2 Points	3 Points	
			21 : 20				
Penatlity				Penatlity			
			21.1:2 ..				
WINNER			Total				

POINTS

Decision of Superiority

Judge 1	Judge 2	Judge 3	Judge 4	Judge 5	Judge 6	Judge 7	Referee

Name _____

Signature _____

Lion Cup 2024 Luxembourg

297 Rue de Reckenthal L-2410 Strassen, LUXEMBOURG

Court Nr.	2	Pool	2	Date	2024-06-08	Field Position	57
RED				BLUE			
NOC	D ONGHIA ENZO (FRA)			NOC	BUISSON MATTO (FRA)		
Category	22 - Kata Male Senior						
3 Points	2 Points	1 Point	Score	1 Point	2 Points	3 Points	
			22 : 22				
Penatlity				Penatlity			
			22.8:2 ..				
WINNER			Total				

POINTS

Decision of Superiority

Judge 1	Judge 2	Judge 3	Judge 4	Judge 5	Judge 6	Judge 7	Referee

Name _____

Signature _____

Lion Cup 2024 Luxembourg

297 Rue de Reckenthal L-2410 Strassen, LUXEMBOURG

Court Nr.	2	Pool	2	Date	2024-06-08	Field Position	58
RED				BLUE			
NOC	ALMEIDA DA SILVA ALEXANDRE (FRA)			NOC	VAN DER HEIJDEN LUCA (NED)		
Category	22 - Kata Male Senior						
3 Points	2 Points	1 Point	Score	1 Point	2 Points	3 Points	
			21 : 21				
Penatlity				Penatlity			
			21.1:2 ..				
			Total	WINNER			

POINTS

Decision of Superiority

Judge 1	Judge 2	Judge 3	Judge 4	Judge 5	Judge 6	Judge 7	Referee

Name _____

Signature _____

Lion Cup 2024 Luxembourg

297 Rue de Reckenthal L-2410 Strassen, LUXEMBOURG

Court Nr.	2	Pool	2	Date	2024-06-08	Field Position	59
RED				BLUE			
NOC	AFONSO MARQUES LEANDRO (LUX)			NOC	DUCHAINE GREGOIRE (FRA)		
Category	22 - Kata Male Senior						
3 Points	2 Points	1 Point	Score	1 Point	2 Points	3 Points	
			21 : 22				
Penatlity				Penatlity			
			21.3:2 ..				
			Total	WINNER			

POINTS

Decision of Superiority

Judge 1	Judge 2	Judge 3	Judge 4	Judge 5	Judge 6	Judge 7	Referee

Name _____

Signature _____

Lion Cup 2024 Luxembourg

297 Rue de Reckenthal L-2410 Strassen, LUXEMBOURG

Court Nr.	2	Pool	2	Date	2024-06-08	Field Position	60
RED				BLUE			
NOC	ASSEMAT REMI (FRA)			NOC	CHAFFORT LUCAS (LUX)		
Category	22 - Kata Male Senior						
3 Points	2 Points	1 Point	Score	1 Point	2 Points	3 Points	
			22 : 23				
Penatlity				Penatlity			
			22.6:2 ..				
			Total	WINNER			

POINTS

Decision of Superiority

Judge 1	Judge 2	Judge 3	Judge 4	Judge 5	Judge 6	Judge 7	Referee

Name _____

Signature _____

Lion Cup 2024 Luxembourg

297 Rue de Reckenthal L-2410 Strassen, LUXEMBOURG

Court Nr.	2	Pool	2	Date	2024-06-08	Field Position	61
RED				BLUE			
NOC	D ONGHIA ENZO (FRA)			NOC	VAN DER HEIJDEN LUCA (NED)		
Category	22 - Kata Male Senior						
3 Points	2 Points	1 Point	Score	1 Point	2 Points	3 Points	
			23 : 23				
Penatlity				Penatlity			
			23.5:2 ..				
WINNER			Total				

POINTS

Decision of Superiority

Judge 1	Judge 2	Judge 3	Judge 4	Judge 5	Judge 6	Judge 7	Referee

Name _____

Signature _____

Lion Cup 2024 Luxembourg

297 Rue de Reckenthal L-2410 Strassen, LUXEMBOURG

Court Nr.	2	Pool	2	Date	2024-06-08	Field Position	62
RED				BLUE			
NOC	DUCHAINE GREGOIRE (FRA)			NOC	CHAFFORT LUCAS (LUX)		
Category	22 - Kata Male Senior						
3 Points	2 Points	1 Point	Score	1 Point	2 Points	3 Points	
			24 : 23				
Penatlity					Penatlity		
				24.6:2 ..			
WINNER				Total			

POINTS

Decision of Superiority

Judge 1	Judge 2	Judge 3	Judge 4	Judge 5	Judge 6	Judge 7	Referee

Name _____

Signature _____

Lion Cup 2024 Luxembourg

297 Rue de Reckenthal L-2410 Strassen, LUXEMBOURG

Court Nr.	2	Pool	2	Date	2024-06-08	Field Position	63
RED				BLUE			
NOC	D ONGHIA ENZO (FRA)			NOC	DUCHAINE GREGOIRE (FRA)		
Category	22 - Kata Male Senior						
3 Points	2 Points	1 Point	Score	1 Point	2 Points	3 Points	
			23 : 24				
Penatlity				Penatlity			
			23.5:2 ..				
			Total	WINNER			

POINTS

Decision of Superiority

Judge 1	Judge 2	Judge 3	Judge 4	Judge 5	Judge 6	Judge 7	Referee

Name _____

Signature _____

Lion Cup 2024 Luxembourg

297 Rue de Reckenthal L-2410 Strassen, LUXEMBOURG

Court Nr.	1	Pool	1	Date	2024-06-08	Field Position	63
RED				BLUE			
NOC	STASSIAUX MAHEL (FRA)			NOC	DUCHAINE GREGOIRE (FRA)		
Category	22 - Kata Male Senior						
3 Points	2 Points	1 Point	Score	1 Point	2 Points	3 Points	
			24 : 23				
Penatlity				Penatlity			
			24.4:2 ..				
WINNER			Total				

POINTS

Decision of Superiority

Judge 1	Judge 2	Judge 3	Judge 4	Judge 5	Judge 6	Judge 7	Referee

Name _____

Signature _____

Lion Cup 2024 Luxembourg

297 Rue de Reckenthal L-2410 Strassen, LUXEMBOURG

Court Nr.	1	Pool	1	Date	2024-06-08	Field Position	0
RED				BLUE			
NOC	BRUSCELLA SAMUELE (LUX)			NOC	GREGOIRE LIAM (FRA)		
Category	22 - Kata Male Senior						
3 Points	2 Points	1 Point	Score	1 Point	2 Points	3 Points	
			22 : 23				
Penatlity				Penatlity			
			22.8:2 ..				
			Total	WINNER			

POINTS

Decision of Superiority

Judge 1	Judge 2	Judge 3	Judge 4	Judge 5	Judge 6	Judge 7	Referee

Name _____

Signature _____

Lion Cup 2024 Luxembourg

297 Rue de Reckenthal L-2410 Strassen, LUXEMBOURG

Court Nr.	1	Pool	1	Date	2024-06-08	Field Position	2
RED				BLUE			
NOC	PETRY KEVIN (LUX)			NOC	BRUSCELLA SAMUELE (LUX)		
Category	22 - Kata Male Senior						
3 Points	2 Points	1 Point	Score	1 Point	2 Points	3 Points	
			22 : 22				
Penatlity				Penatlity			
			22.2:2 ..				
			Total	WINNER			

POINTS

Decision of Superiority









Judge 1	Judge 2	Judge 3	Judge 4	Judge 5	Judge 6	Judge 7	Referee

Name _____

Signature _____

Lion Cup 2024 Luxembourg - 2024-06-07

Official Results

22 - Kata Male Senior			
1	STASSIAUX MAHEL		FRA - FRANCE
2	DUCHAINÉ GREGOIRE		FRA - FRANCE
3	GREGOIRE LIAM		FRA - FRANCE
3	CHAFFORT LUCAS		LUX - LUXEMBOURG
5	BRUSCELLA SAMUELE		LUX - LUXEMBOURG
5	D ONGHIA ENZO		FRA - FRANCE
7	PETRY KEVIN		LUX - LUXEMBOURG
7	AFONSO MARQUES LEANDRO		LUX - LUXEMBOURG

KUMITE FEMALE U12 -30KG

Lion Cup 2024 Luxembourg

ENTRIES BY WEIGHT CATEGORY
KUMITE FEMALE U12 -30KG

As of 8 JUN 2024

NOC Code	Gender	Name	Seeding
BEL	F	Albu Diana	
BEL	F	COMPAGNON Salsabile	
BEL	F	De Wilde Noa	
FRA	F	BOURAHLA Massyla	
FRA	F	Tchaldaev Halimat	
GER	F	Satter Anna	
GER	F	Satter Sara	
LUX	F	Cornet Marissa	
LUX	F	Moens Adele	
LUX	F	Parois Allegra	
LUX	F	Vanaudenhove Victoria	
SUI	F	Battistel Julia	
SUI	F	Dontsis Zoi	
SUI	F	Schwerzmann Mona	

KUMITE FEMALE U12 -30KG

Lion Cup 2024 Luxembourg, 297 Rue de Reckenthal L-2410 Strassen, LUX

2024-06-08

Tatami
5 14:50

Pool
1 / 1

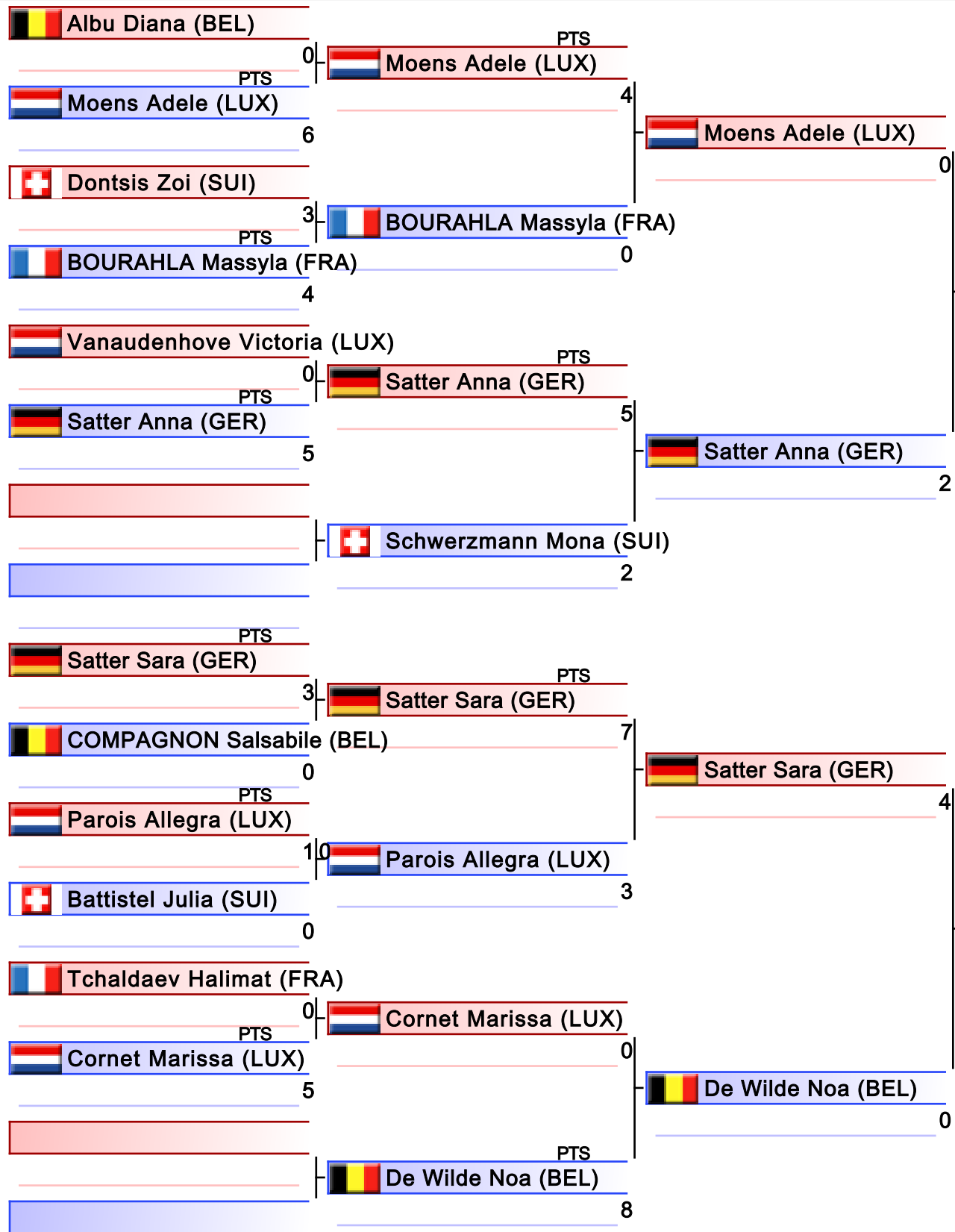

Final



1. SATTER SARA (GER)
2. SATTER ANNA (GER)
3. MOENS ADELE (LUX)
3. DE WILDE NOA (BEL)
5. SCHWERZMANN MONA (SUI)
5. PAROIS ALLEGRA (LUX)
7. VANAUDENHOVE VICTORIA (LUX)
7. COMPAGNON SALSABILE (BEL)

KUMITE FEMALE U12 -30KG

Lion Cup 2024 Luxembourg

2024-06-08

Tatami
5 15:25

Pool
1

(c)sportdata GmbH & Co KG 2000-2024 (2024-06-08 18:41) v 10.1.0 build 1 (2024-01-24 23:23 CET) License: Online_Event_ID-7672_LionCup2024Luxembourg (expire 2024-06-21)

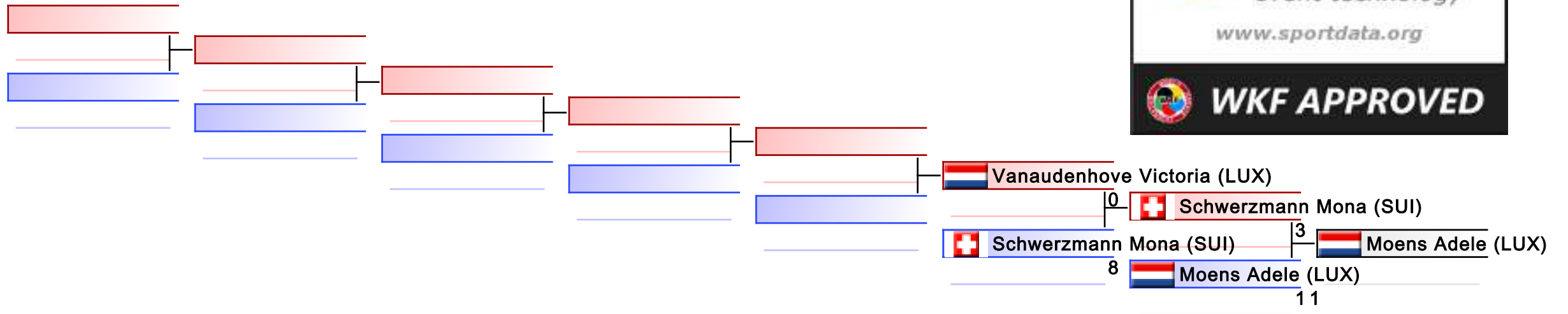

REPECHAGE: (1)

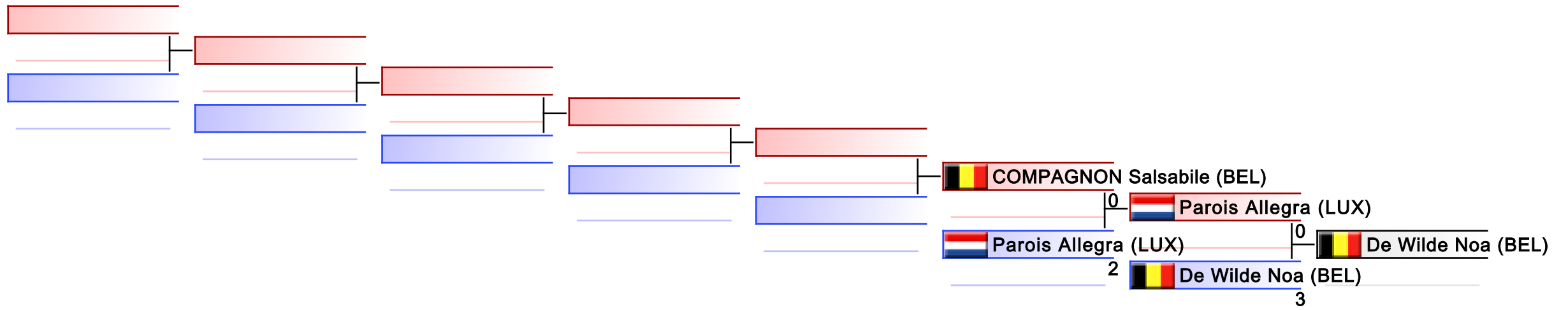

Lion Cup 2024 Luxembourg

297 Rue de Reckenthal L-2410 Strassen, LUXEMBOURG

Court Nr.	1	Pool	1	Date	2024-06-08	Field Position	49
RED				BLUE			
NOC	ALBU DIANA (BEL)			NOC	MOENS ADELE (LUX)		
Category	KUMITE FEMALE U12 -30KG						
3 Points	2 Points	1 Point	Score	1 Point	2 Points	3 Points	
			0 : 6				
Penatlity				Penatlity			
C1: , C2:			0:6	C1: C3, C2:			
			Total	WINNER			

PTS

Decision of Superiority

Judge 1	Judge 2	Judge 3	Judge 4	Judge 5	Judge 6	Judge 7	Referee

Name _____

Signature _____

Lion Cup 2024 Luxembourg

297 Rue de Reckenthal L-2410 Strassen, LUXEMBOURG

Court Nr.	1	Pool	1	Date	2024-06-08	Field Position	50	
RED				BLUE				
NOC	DONTSIS ZOI (SUI)			NOC	BOURAHLA MASSYLA (FRA)			
Category	KUMITE FEMALE U12 -30KG							
3 Points	2 Points	1 Point	Score	1 Point	2 Points	3 Points		
			3 : 4					
Penatlity				Penatlity				
C1: C1, C2:				3:4	C1: HC, C2:			
				Total	WINNER			

PTS

Decision of Superiority

Judge 1	Judge 2	Judge 3	Judge 4	Judge 5	Judge 6	Judge 7	Referee

Name _____

Signature _____

Lion Cup 2024 Luxembourg

297 Rue de Reckenthal L-2410 Strassen, LUXEMBOURG

Court Nr.	1	Pool	1	Date	2024-06-08	Field Position	51	
RED				BLUE				
NOC	VANAUDENHOVE VICTORIA (LUX)			NOC	SATTER ANNA (GER)			
Category	KUMITE FEMALE U12 -30KG							
3 Points	2 Points	1 Point	Score	1 Point	2 Points	3 Points		
			0 : 5					
Penatlity				Penatlity				
C1: , C2:				0:5	C1: C3, C2:			
				Total	WINNER			

PTS

Decision of Superiority

Judge 1	Judge 2	Judge 3	Judge 4	Judge 5	Judge 6	Judge 7	Referee

Name _____

Signature _____

Lion Cup 2024 Luxembourg

297 Rue de Reckenthal L-2410 Strassen, LUXEMBOURG

Court Nr.	1	Pool	1	Date	2024-06-08	Field Position	53
RED				BLUE			
NOC	SATTER SARA (GER)			NOC	COMPAGNON SALSABILE (BEL)		
Category	KUMITE FEMALE U12 -30KG						
3 Points	2 Points	1 Point	Score	1 Point	2 Points	3 Points	
			3 : 0				
Penatlity				Penatlity			
C1: , C2:				3:0	C1: , C2:		
WINNER				Total			

PTS

Decision of Superiority

Judge 1	Judge 2	Judge 3	Judge 4	Judge 5	Judge 6	Judge 7	Referee

Name _____

Signature _____

Lion Cup 2024 Luxembourg

297 Rue de Reckenthal L-2410 Strassen, LUXEMBOURG

Court Nr.	1	Pool	1	Date	2024-06-08	Field Position	54	
RED				BLUE				
NOC	PAROIS ALLEGRA (LUX)			NOC	BATTISTEL JULIA (SUI)			
Category	KUMITE FEMALE U12 -30KG							
3 Points	2 Points	1 Point	Score	1 Point	2 Points	3 Points		
			10 : 0					
Penatlity				Penatlity				
			C1: , C2:	10:0				C1: , C2:
			WINNER	Total				

PTS

Decision of Superiority

Judge 1	Judge 2	Judge 3	Judge 4	Judge 5	Judge 6	Judge 7	Referee

Name _____

Signature _____

Lion Cup 2024 Luxembourg

297 Rue de Reckenthal L-2410 Strassen, LUXEMBOURG

Court Nr.	1	Pool	1	Date	2024-06-08	Field Position	55
RED				BLUE			
NOC	TCHALDAEV HALIMAT (FRA)			NOC	CORNET MARISSA (LUX)		
Category	KUMITE FEMALE U12 -30KG						
3 Points	2 Points	1 Point	Score	1 Point	2 Points	3 Points	
			0 : 5				
Penatlity				Penatlity			
C1: , C2:				0:5	C1: C1, C2:		
				Total	WINNER		

PTS

Decision of Superiority

Judge 1	Judge 2	Judge 3	Judge 4	Judge 5	Judge 6	Judge 7	Referee

Name _____

Signature _____

Lion Cup 2024 Luxembourg

297 Rue de Reckenthal L-2410 Strassen, LUXEMBOURG

Court Nr.	1	Pool	1	Date	2024-06-08	Field Position	57	
RED				BLUE				
NOC	MOENS ADELE (LUX)			NOC	BOURAHLA MASSYLA (FRA)			
Category	KUMITE FEMALE U12 -30KG							
3 Points	2 Points	1 Point	Score	1 Point	2 Points	3 Points		
			4 : 0					
Penatlity				Penatlity				
C1: C1, C2:				4:0	C1: C1, C2:			
WINNER				Total				

PTS

Decision of Superiority

Judge 1	Judge 2	Judge 3	Judge 4	Judge 5	Judge 6	Judge 7	Referee

Name _____

Signature _____

Lion Cup 2024 Luxembourg

297 Rue de Reckenthal L-2410 Strassen, LUXEMBOURG

Court Nr.	1	Pool	1	Date	2024-06-08	Field Position	58	
RED				BLUE				
NOC	SATTER ANNA (GER)			NOC	SCHWERZMANN MONA (SUI)			
Category	KUMITE FEMALE U12 -30KG							
3 Points	2 Points	1 Point	Score	1 Point	2 Points	3 Points		
			5 : 2					
Penatlity					Penatlity			
C1: HC, C2:				5:2	C1: C1, C2:			
WINNER				Total				

PTS

Decision of Superiority

Judge 1	Judge 2	Judge 3	Judge 4	Judge 5	Judge 6	Judge 7	Referee

Name _____

Signature _____

Lion Cup 2024 Luxembourg

297 Rue de Reckenthal L-2410 Strassen, LUXEMBOURG

Court Nr.	1	Pool	1	Date	2024-06-08	Field Position	59
RED				BLUE			
NOC	SATTER SARA (GER)			NOC	PAROIS ALLEGRA (LUX)		
Category	KUMITE FEMALE U12 -30KG						
3 Points	2 Points	1 Point	Score	1 Point	2 Points	3 Points	
			7 : 3				
Penatlity				Penatlity			
C1: , C2:			7:3	C1: , C2:			
WINNER			Total				

PTS

Decision of Superiority

Judge 1	Judge 2	Judge 3	Judge 4	Judge 5	Judge 6	Judge 7	Referee

Name _____

Signature _____

Lion Cup 2024 Luxembourg

297 Rue de Reckenthal L-2410 Strassen, LUXEMBOURG

Court Nr.	1	Pool	1	Date	2024-06-08	Field Position	60
RED				BLUE			
NOC	CORNET MARISSA (LUX)			NOC	DE WILDE NOA (BEL)		
Category	KUMITE FEMALE U12 -30KG						
3 Points	2 Points	1 Point	Score	1 Point	2 Points	3 Points	
			0 : 8				
Penatlity				Penatlity			
C1: C2, C2:				0:8	C1: , C2:		
				Total	WINNER		

PTS

Decision of Superiority

Judge 1	Judge 2	Judge 3	Judge 4	Judge 5	Judge 6	Judge 7	Referee

Name _____

Signature _____

Lion Cup 2024 Luxembourg

297 Rue de Reckenthal L-2410 Strassen, LUXEMBOURG

Court Nr.	1	Pool	1	Date	2024-06-08	Field Position	61
RED				BLUE			
NOC	MOENS ADELE (LUX)			NOC	SATTER ANNA (GER)		
Category	KUMITE FEMALE U12 -30KG						
3 Points	2 Points	1 Point	Score	1 Point	2 Points	3 Points	
			0 : 2				
Penatlity				Penatlity			
C1: , C2:			0:2	C1: , C2:			
			Total	WINNER			

Decision of Superiority

Judge 1	Judge 2	Judge 3	Judge 4	Judge 5	Judge 6	Judge 7	Referee

Name _____

Signature _____

Lion Cup 2024 Luxembourg

297 Rue de Reckenthal L-2410 Strassen, LUXEMBOURG

Court Nr.	1	Pool	1	Date	2024-06-08	Field Position	62	
RED				BLUE				
NOC	SATTER SARA (GER)			NOC	DE WILDE NOA (BEL)			
Category	KUMITE FEMALE U12 -30KG							
3 Points	2 Points	1 Point	Score	1 Point	2 Points	3 Points		
			4 : 0					
Penatlity				Penatlity				
C1: C1, C2:				4:0	C1: C1, C2:			
WINNER				Total				

Decision of Superiority

Judge 1	Judge 2	Judge 3	Judge 4	Judge 5	Judge 6	Judge 7	Referee

Name _____

Signature _____

Lion Cup 2024 Luxembourg

297 Rue de Reckenthal L-2410 Strassen, LUXEMBOURG

Court Nr.	1	Pool	1	Date	2024-06-08	Field Position	63	
RED				BLUE				
NOC	SATTER ANNA (GER)			NOC	SATTER SARA (GER)			
Category	KUMITE FEMALE U12 -30KG							
3 Points	2 Points	1 Point	Score	1 Point	2 Points	3 Points		
			1 : 1					
Penatlity				Penatlity				
C1: HC, C2:				1:1	C1: C1, C2:			
				Total	WINNER			

Decision of Superiority

Judge 1	Judge 2	Judge 3	Judge 4	Judge 5	Judge 6	Judge 7	Referee

Name _____

Signature _____

Lion Cup 2024 Luxembourg

297 Rue de Reckenthal L-2410 Strassen, LUXEMBOURG

Court Nr.	1	Pool	1	Date	2024-06-08	Field Position	0
RED				BLUE			
NOC	SCHWERZMANN MONA (SUI)			NOC	MOENS ADELE (LUX)		
Category	KUMITE FEMALE U12 -30KG						
3 Points	2 Points	1 Point	Score	1 Point	2 Points	3 Points	
			3 : 11				
Penatlity				Penatlity			
C1: , C2:			3:11	C1: C1, C2:			
			Total	WINNER			

Decision of Superiority

Judge 1	Judge 2	Judge 3	Judge 4	Judge 5	Judge 6	Judge 7	Referee

Name _____

Signature _____

Lion Cup 2024 Luxembourg

297 Rue de Reckenthal L-2410 Strassen, LUXEMBOURG

Court Nr.	1	Pool	1	Date	2024-06-08	Field Position	2
RED				BLUE			
NOC	VANAUDENHOVE VICTORIA (LUX)			NOC	SCHWERZMANN MONA (SUI)		
Category	KUMITE FEMALE U12 -30KG						
3 Points	2 Points	1 Point	Score	1 Point	2 Points	3 Points	
			:				
Penatlity				Penatlity			
			Total				

Decision of Superiority

Judge 1	Judge 2	Judge 3	Judge 4	Judge 5	Judge 6	Judge 7	Referee

Name _____

Signature _____

Lion Cup 2024 Luxembourg

297 Rue de Reckenthal L-2410 Strassen, LUXEMBOURG

Court Nr.	2	Pool	2	Date	2024-06-08	Field Position	0
RED				BLUE			
NOC	PAROIS ALLEGRA (LUX)			NOC	DE WILDE NOA (BEL)		
Category	KUMITE FEMALE U12 -30KG						
3 Points	2 Points	1 Point	Score	1 Point	2 Points	3 Points	
			0 : 3				
Penatlity				Penatlity			
C1: , C2:				0:3	C1: , C2:		
				Total	WINNER		

Decision of Superiority

Judge 1	Judge 2	Judge 3	Judge 4	Judge 5	Judge 6	Judge 7	Referee

Name _____

Signature _____

Lion Cup 2024 Luxembourg

297 Rue de Reckenthal L-2410 Strassen, LUXEMBOURG

Court Nr.	2	Pool	2	Date	2024-06-08	Field Position	2
RED				BLUE			
NOC	COMPAGNON SALSABILE (BEL)			NOC	PAROIS ALLEGRA (LUX)		
Category	KUMITE FEMALE U12 -30KG						
3 Points	2 Points	1 Point	Score	1 Point	2 Points	3 Points	
			0 : 2				
Penatlity					Penatlity		
C1: HC, C2:				0:2	C1: , C2:		
				Total	WINNER		

Decision of Superiority

Judge 1	Judge 2	Judge 3	Judge 4	Judge 5	Judge 6	Judge 7	Referee

Name _____

Signature _____

Official Results

KUMITE FEMALE U12 -30KG			
1	SATTER SARA		GER - GERMANY
2	SATTER ANNA		GER - GERMANY
3	MOENS ADELE		LUX - LUXEMBOURG
3	DE WILDE NOA		BEL - BELGIUM
5	SCHWERZMANN MONA		SUI - SWITZERLAND
5	PAROIS ALLEGRA		LUX - LUXEMBOURG
7	VANAUDENHOVE VICTORIA		LUX - LUXEMBOURG
7	COMPAGNON SALSABILE		BEL - BELGIUM

KUMITE FEMALE U14 +52KG

Lion Cup 2024 Luxembourg

ENTRIES BY WEIGHT CATEGORY
KUMITE FEMALE U14 +52KG

As of 8 JUN 2024

NOC Code	Gender	Name	Seeding
ALG	F	TOUIDJINE SAMAH ZOULIKHA	
BEL	F	BOUHNA Assiya	
FRA	F	Geyikpinar Melissa	
FRA	F	Smaili Anfel	
GER	F	Paulus Chayenne	
LUX	F	Pierantoni Nora	
LUX	F	Plingers Aleonor	
NED	F	Leurs Lily	
NED	F	Tenzali Romaissa	
SUI	F	Tiefenauer Lena	
SUI	F	Weiss Tiffany	

KUMITE FEMALE U14 +52KG

Lion Cup 2024 Luxembourg, 297 Rue de Reckenthal L-2410 Strassen, LUX

2024-06-08

Tatami
6 13:40

Pool
1 / 1

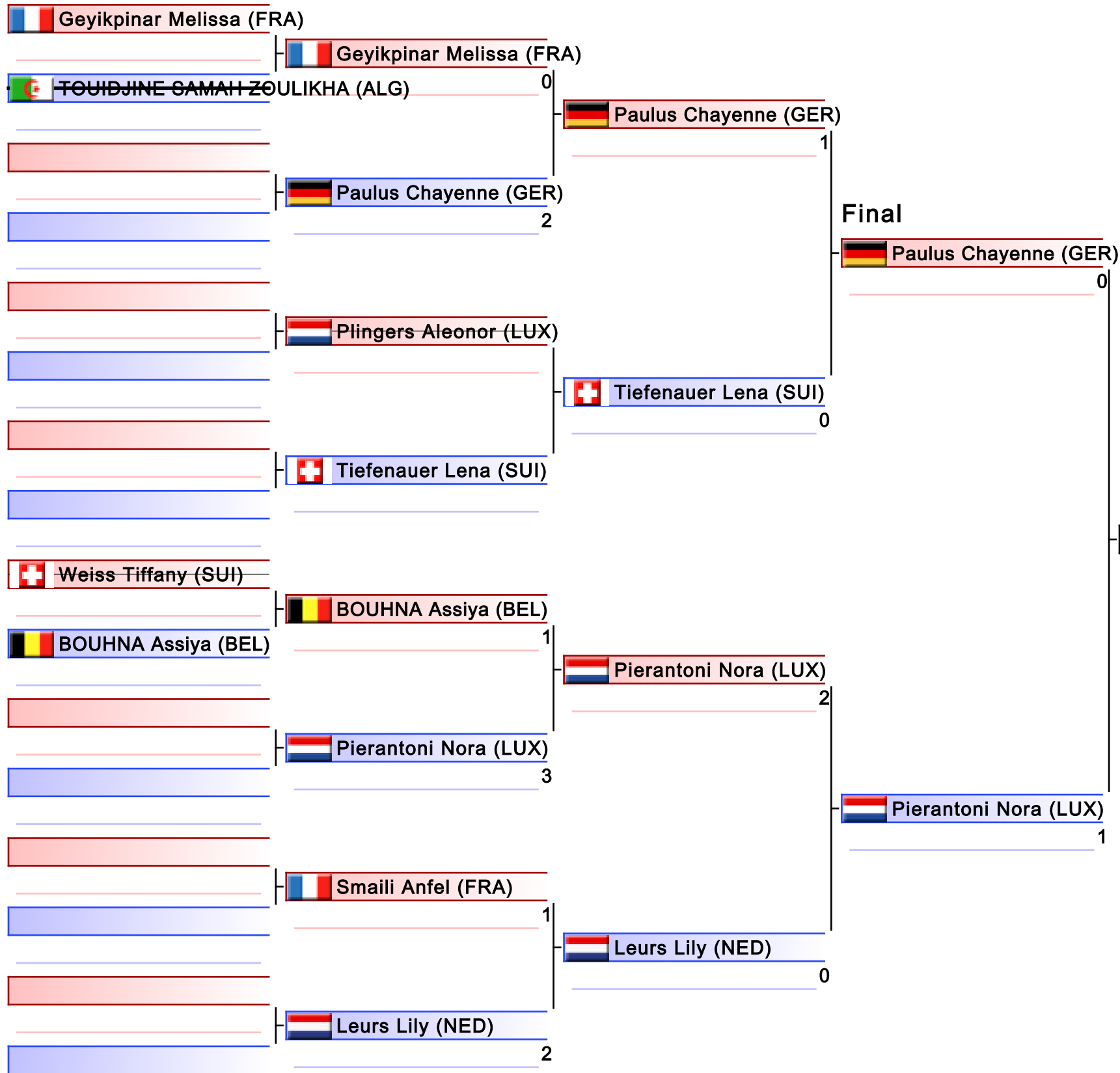

1. PIERANTONI NORA (LUX)
2. PAULUS CHAYENNE (GER)
3. GEYIKPINAR MELISSA (FRA)
3. LEURS LILY (NED)
5. TIEFENAUER LENA (SUI)
5. BOUHNA ASSIYA (BEL)

KUMITE FEMALE U14 +52KG

Lion Cup 2024 Luxembourg



2024-06-08

Tatami
6 14:20

Pool
1

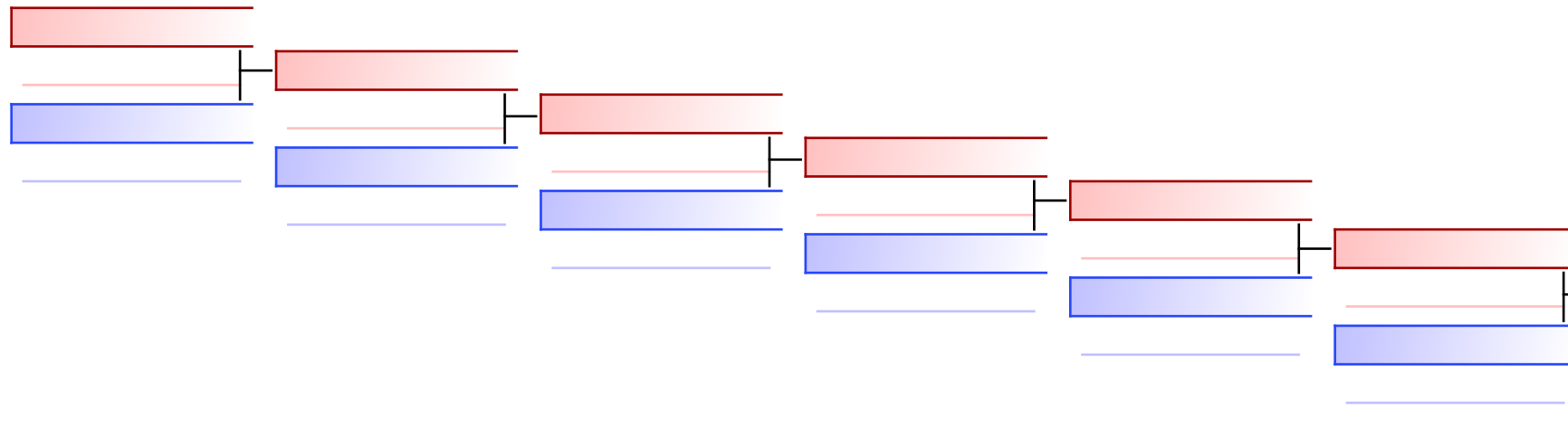

(c)sportdata GmbH & Co KG 2000-2024 (2024-06-08 18:41) v 10.1.0 build 1 (2024-01-24 23:23 CET) License: Online_Event_ID-7672_LionCup2024Luxembourg (expire 2024-06-21)

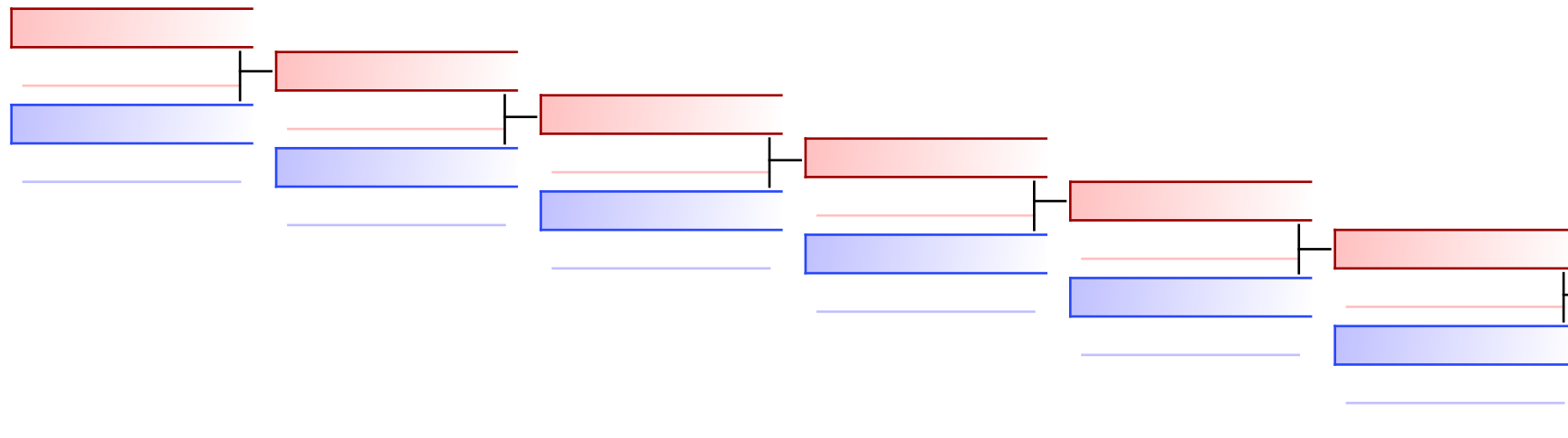

 Geyikpinar Melissa (FRA)
1
 Geyikpinar Melissa (FRA)
 Tiefenauer Lena (SUI)
0

REPECHAGE: (1)



 BOUHNA Assiya (BEL)
0
 Leurs Lily (NED)
 Leurs Lily (NED)
4

Lion Cup 2024 Luxembourg

297 Rue de Reckenthal L-2410 Strassen, LUXEMBOURG

Court Nr.	1	Pool	1	Date	2024-06-08	Field Position	57
RED				BLUE			
NOC	GEYIKPINAR MELISSA (FRA)			NOC	PAULUS CHAYENNE (GER)		
Category	KUMITE FEMALE U14 +52KG						
3 Points	2 Points	1 Point	Score	1 Point	2 Points	3 Points	
			0 : 2				
Penatlity				Penatlity			
C1: , C2:				0:2	C1: , C2:		
				Total	WINNER		

Decision of Superiority

Judge 1	Judge 2	Judge 3	Judge 4	Judge 5	Judge 6	Judge 7	Referee

Name _____

Signature _____

Lion Cup 2024 Luxembourg

297 Rue de Reckenthal L-2410 Strassen, LUXEMBOURG

Court Nr.	1	Pool	1	Date	2024-06-08	Field Position	59	
RED				BLUE				
NOC	BOUHNA ASSIYA (BEL)			NOC	PIERANTONI NORA (LUX)			
Category	KUMITE FEMALE U14 +52KG							
3 Points	2 Points	1 Point	Score	1 Point	2 Points	3 Points		
			1 : 3					
Penatlity				Penatlity				
C1: , C2:				1:3	C1: HC, C2:			
				Total	WINNER			

Decision of Superiority

Judge 1	Judge 2	Judge 3	Judge 4	Judge 5	Judge 6	Judge 7	Referee

Name _____

Signature _____

Lion Cup 2024 Luxembourg

297 Rue de Reckenthal L-2410 Strassen, LUXEMBOURG

Court Nr.	1	Pool	1	Date	2024-06-08	Field Position	60
RED				BLUE			
NOC	SMAILI ANFEL (FRA)			NOC	LEURS LILY (NED)		
Category	KUMITE FEMALE U14 +52KG						
3 Points	2 Points	1 Point	Score	1 Point	2 Points	3 Points	
			1 : 2				
Penatlity				Penatlity			
C1: C1, C2:				1:2	C1: , C2:		
				Total	WINNER		

Decision of Superiority

Judge 1	Judge 2	Judge 3	Judge 4	Judge 5	Judge 6	Judge 7	Referee

Name _____

Signature _____

Lion Cup 2024 Luxembourg

297 Rue de Reckenthal L-2410 Strassen, LUXEMBOURG

Court Nr.	1	Pool	1	Date	2024-06-08	Field Position	61
RED				BLUE			
NOC	PAULUS CHAYENNE (GER)			NOC	TIEFENAUER LENA (SUI)		
Category	KUMITE FEMALE U14 +52KG						
3 Points	2 Points	1 Point	Score	1 Point	2 Points	3 Points	
			1 : 0				
Penatlity				Penatlity			
C1: , C2:				1:0	C1: , C2:		
WINNER				Total			

Decision of Superiority

Judge 1	Judge 2	Judge 3	Judge 4	Judge 5	Judge 6	Judge 7	Referee

Name _____

Signature _____

Lion Cup 2024 Luxembourg

297 Rue de Reckenthal L-2410 Strassen, LUXEMBOURG

Court Nr.	1	Pool	1	Date	2024-06-08	Field Position	62
RED				BLUE			
NOC	PIERANTONI NORA (LUX)			NOC	LEURS LILY (NED)		
Category	KUMITE FEMALE U14 +52KG						
3 Points	2 Points	1 Point	Score	1 Point	2 Points	3 Points	
			2 : 0				
Penatlity				Penatlity			
C1: C3, C2:				2:0	C1: , C2:		
WINNER				Total			

Decision of Superiority

Judge 1	Judge 2	Judge 3	Judge 4	Judge 5	Judge 6	Judge 7	Referee

Name _____

Signature _____

Lion Cup 2024 Luxembourg

297 Rue de Reckenthal L-2410 Strassen, LUXEMBOURG

Court Nr.	1	Pool	1	Date	2024-06-08	Field Position	63
RED				BLUE			
NOC	PAULUS CHAYENNE (GER)			NOC	PIERANTONI NORA (LUX)		
Category	KUMITE FEMALE U14 +52KG						
3 Points	2 Points	1 Point	Score	1 Point	2 Points	3 Points	
			0 : 1				
Penatlity				Penatlity			
C1: C1, C2:				0:1	C1: , C2:		
				Total	WINNER		

Decision of Superiority

Judge 1	Judge 2	Judge 3	Judge 4	Judge 5	Judge 6	Judge 7	Referee

Name _____

Signature _____

Lion Cup 2024 Luxembourg

297 Rue de Reckenthal L-2410 Strassen, LUXEMBOURG

Court Nr.	1	Pool	1	Date	2024-06-08	Field Position	0
RED				BLUE			
NOC	GEYIKPINAR MELISSA (FRA)			NOC	TIEFENAUER LENA (SUI)		
Category	KUMITE FEMALE U14 +52KG						
3 Points	2 Points	1 Point	Score	1 Point	2 Points	3 Points	
			:				
Penatlity				Penatlity			
			Total				

Decision of Superiority

Judge 1	Judge 2	Judge 3	Judge 4	Judge 5	Judge 6	Judge 7	Referee

Name _____

Signature _____

Lion Cup 2024 Luxembourg

297 Rue de Reckenthal L-2410 Strassen, LUXEMBOURG

Court Nr.	2	Pool	2	Date	2024-06-08	Field Position	0	
RED				BLUE				
NOC	BOUHNA ASSIYA (BEL)			NOC	LEURS LILY (NED)			
Category	KUMITE FEMALE U14 +52KG							
3 Points	2 Points	1 Point	Score	1 Point	2 Points	3 Points		
			0 : 4					
Penatlity				Penatlity				
C1: , C2:				0:4	C1: HC, C2:			
				Total	WINNER			

Decision of Superiority

Judge 1	Judge 2	Judge 3	Judge 4	Judge 5	Judge 6	Judge 7	Referee

Name _____

Signature _____

Official Results

KUMITE FEMALE U14 +52KG			
1	PIERANTONI NORA		LUX - LUXEMBOURG
2	PAULUS CHAYENNE		GER - GERMANY
3	GEYIKPINAR MELISSA		FRA - FRANCE
3	LEURS LILY		NED - NETHERLANDS
5	TIEFENAUER LENA		SUI - SWITZERLAND
5	BOUHNA ASSIYA		BEL - BELGIUM

KUMITE FEMALE U14 -47KG

Lion Cup 2024 Luxembourg

ENTRIES BY WEIGHT CATEGORY
KUMITE FEMALE U14 -47KG

As of 8 JUN 2024

NOC Code	Gender	Name	Seeding
BEL	F	Guetari Yakin	
BEL	F	Kurtalic Sherazad	
FRA	F	stagni maelie	
LUX	F	Belabass Zineb	
LUX	F	Intini Raffaelli Lara	
LUX	F	Kessel Alexia	
NED	F	Loek Isa	
NED	F	Pcholko Varvara	
NED	F	Polianska Yuliia	
NED	F	Vlieland Kayleigh	
SUI	F	Büchler Sofia	
SUI	F	Gnägi Naya	
SUI	F	Näf Sylvie	

KUMITE FEMALE U14 -47KG

Lion Cup 2024 Luxembourg, 297 Rue de Reckenthal L-2410 Strassen, LUX

2024-06-08

Tatami
1 14:40

Pool
1 / 1

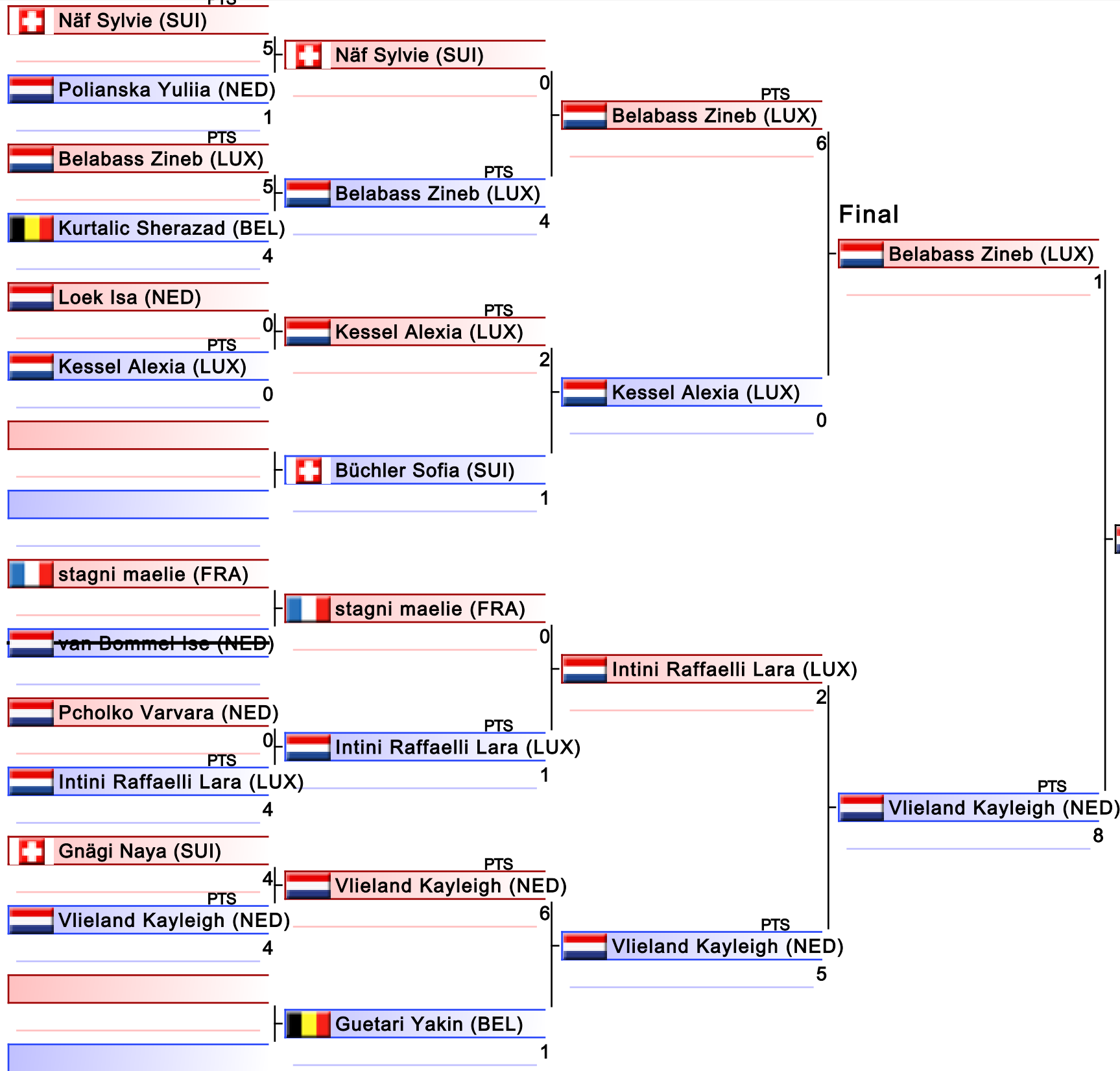

1. VLIELAND KAYLEIGH (NED)
2. BELABASS ZINEB (LUX)
3. NÄF SYLVIE (SUI)
3. GUETARI YAKIN (BEL)
5. KESSEL ALEXIA (LUX)
5. INTINI RAFFAELLI LARA (LUX)
7. KURTALIC SHERAZAD (BEL)
7. GNÄGI NAYA (SUI)

KUMITE FEMALE U14 -47KG

Lion Cup 2024 Luxembourg

2024-06-08

Tatami
1 15:30

Pool
1

(c)sportdata GmbH & Co KG 2000-2024 (2024-06-08 18:41) v 10.1.0 build 1 (2024-01-24 23:23 CET) License: Online_Event_ID-7672_LionCup2024Luxembourg (expire 2024-06-21)

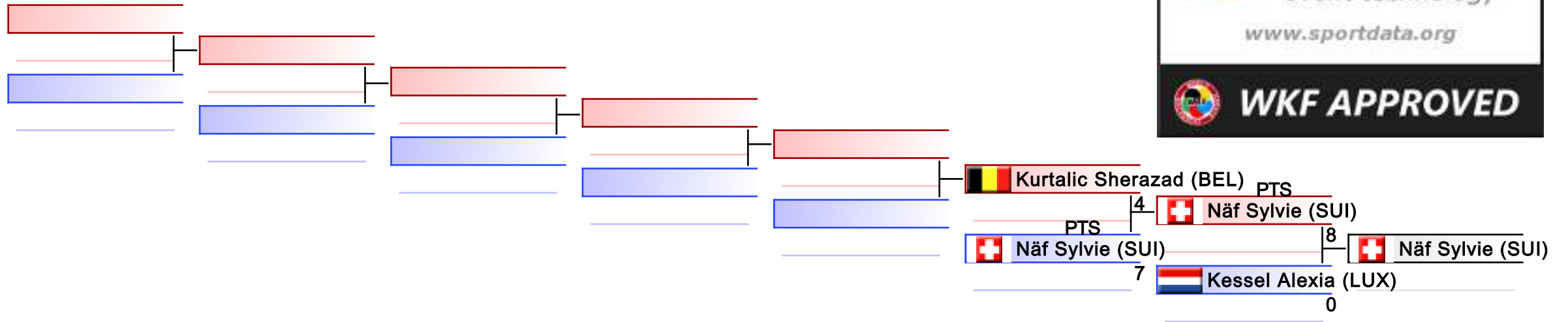

REPECHAGE: (1)

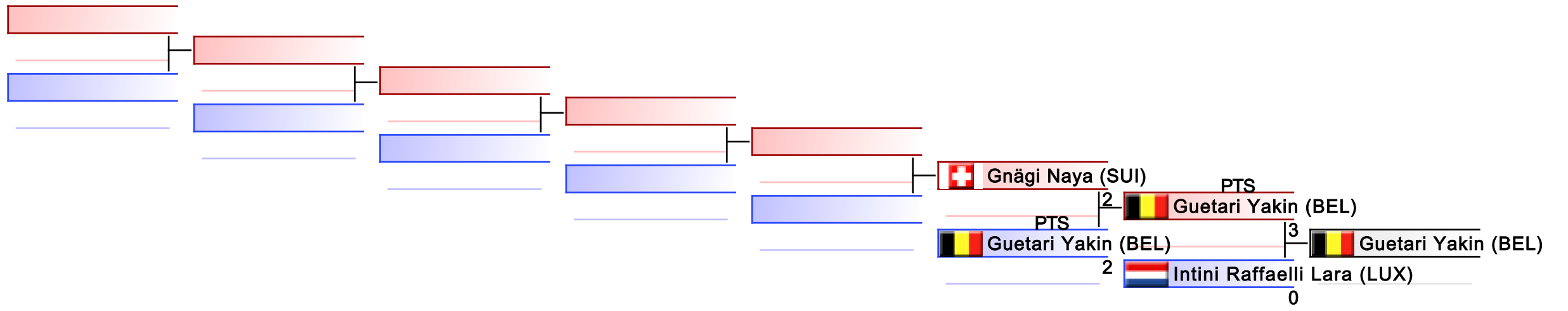

Lion Cup 2024 Luxembourg

297 Rue de Reckenthal L-2410 Strassen, LUXEMBOURG

Court Nr.	1	Pool	1	Date	2024-06-08	Field Position	49	
RED				BLUE				
NOC	NF SYLVIE (SUI)			NOC	POLIANSKA YULIIA (NED)			
Category	KUMITE FEMALE U14 -47KG							
3 Points	2 Points	1 Point	Score	1 Point	2 Points	3 Points		
			5 : 1					
Penatlity				Penatlity				
C1: , C2:				5:1	C1: HC, C2:			
WINNER				Total				

PTS

Decision of Superiority

Judge 1	Judge 2	Judge 3	Judge 4	Judge 5	Judge 6	Judge 7	Referee

Name _____

Signature _____

Lion Cup 2024 Luxembourg

297 Rue de Reckenthal L-2410 Strassen, LUXEMBOURG

Court Nr.	1	Pool	1	Date	2024-06-08	Field Position	50
RED				BLUE			
NOC	BELABASS ZINEB (LUX)			NOC	KURTALIC SHERAZAD (BEL)		
Category	KUMITE FEMALE U14 -47KG						
3 Points	2 Points	1 Point	Score	1 Point	2 Points	3 Points	
			5 : 4				
Penatlity				Penatlity			
C1: , C2:				5:4	C1: , C2:		
WINNER				Total			

PTS

Decision of Superiority

Judge 1	Judge 2	Judge 3	Judge 4	Judge 5	Judge 6	Judge 7	Referee

Name _____

Signature _____

Lion Cup 2024 Luxembourg

297 Rue de Reckenthal L-2410 Strassen, LUXEMBOURG

Court Nr.	1	Pool	1	Date	2024-06-08	Field Position	51	
RED				BLUE				
NOC	LOEK ISA (NED)			NOC	KESSEL ALEXIA (LUX)			
Category	KUMITE FEMALE U14 -47KG							
3 Points	2 Points	1 Point	Score	1 Point	2 Points	3 Points		
			0 : 0					
Penatlity				Penatlity				
C1: , C2:				0:0	C1: , C2:			
				Total	WINNER			

PTS

Decision of Superiority

Judge 1	Judge 2	Judge 3	Judge 4	Judge 5	Judge 6	Judge 7	Referee

Name _____

Signature _____

Lion Cup 2024 Luxembourg

297 Rue de Reckenthal L-2410 Strassen, LUXEMBOURG

Court Nr.	1	Pool	1	Date	2024-06-08	Field Position	54
RED				BLUE			
NOC	PCHOLKO VARVARA (NED)			NOC	INTINI RAFFAELLI LARA (LUX)		
Category	KUMITE FEMALE U14 -47KG						
3 Points	2 Points	1 Point	Score	1 Point	2 Points	3 Points	
			0 : 4				
Penatlity				Penatlity			
C1: , C2:			0:4	C1: C1, C2:			
			Total	WINNER			

PTS

Decision of Superiority

Judge 1	Judge 2	Judge 3	Judge 4	Judge 5	Judge 6	Judge 7	Referee

Name _____

Signature _____

Lion Cup 2024 Luxembourg

297 Rue de Reckenthal L-2410 Strassen, LUXEMBOURG

Court Nr.	1	Pool	1	Date	2024-06-08	Field Position	55	
RED				BLUE				
NOC	GNGI NAYA (SUI)			NOC	VLIELAND KAYLEIGH (NED)			
Category	KUMITE FEMALE U14 -47KG							
3 Points	2 Points	1 Point	Score	1 Point	2 Points	3 Points		
			4 : 4					
Penatlity				Penatlity				
C1: HC, C2:				4:4	C1: HC, C2:			
				Total	WINNER			

PTS

Decision of Superiority

Judge 1	Judge 2	Judge 3	Judge 4	Judge 5	Judge 6	Judge 7	Referee

Name _____

Signature _____

Lion Cup 2024 Luxembourg

297 Rue de Reckenthal L-2410 Strassen, LUXEMBOURG

Court Nr.	1	Pool	1	Date	2024-06-08	Field Position	57
RED				BLUE			
NOC	NF SYLVIE (SUI)			NOC	BELABASS ZINEB (LUX)		
Category	KUMITE FEMALE U14 -47KG						
3 Points	2 Points	1 Point	Score	1 Point	2 Points	3 Points	
			0 : 4				
Penatlity				Penatlity			
C1: C1, C2:				0:4	C1: C2, C2:		
				Total	WINNER		

PTS

Decision of Superiority

Judge 1	Judge 2	Judge 3	Judge 4	Judge 5	Judge 6	Judge 7	Referee

Name _____

Signature _____

Lion Cup 2024 Luxembourg

297 Rue de Reckenthal L-2410 Strassen, LUXEMBOURG

Court Nr.	1	Pool	1	Date	2024-06-08	Field Position	58
RED				BLUE			
NOC	KESSEL ALEXIA (LUX)			NOC	BCHLER SOFIA (SUI)		
Category	KUMITE FEMALE U14 -47KG						
3 Points	2 Points	1 Point	Score	1 Point	2 Points	3 Points	
			2 : 1				
Penatlity				Penatlity			
C1: C1, C2:				2:1	C1: C3, C2:		
WINNER				Total			

PTS

Decision of Superiority

Judge 1	Judge 2	Judge 3	Judge 4	Judge 5	Judge 6	Judge 7	Referee

Name _____

Signature _____

Lion Cup 2024 Luxembourg

297 Rue de Reckenthal L-2410 Strassen, LUXEMBOURG

Court Nr.	1	Pool	1	Date	2024-06-08	Field Position	59	
RED				BLUE				
NOC	STAGNI MAELIE (FRA)			NOC	INTINI RAFFAELLI LARA (LUX)			
Category	KUMITE FEMALE U14 -47KG							
3 Points	2 Points	1 Point	Score	1 Point	2 Points	3 Points		
			0 : 1					
Penatlity				Penatlity				
C1: C1, C2:				0:1	C1: C1, C2:			
				Total	WINNER			

PTS

Decision of Superiority

Judge 1	Judge 2	Judge 3	Judge 4	Judge 5	Judge 6	Judge 7	Referee

Name _____

Signature _____

Lion Cup 2024 Luxembourg

297 Rue de Reckenthal L-2410 Strassen, LUXEMBOURG

Court Nr.	1	Pool	1	Date	2024-06-08	Field Position	60	
RED				BLUE				
NOC	VLIELAND KAYLEIGH (NED)			NOC	GUETARI YAKIN (BEL)			
Category	KUMITE FEMALE U14 -47KG							
3 Points	2 Points	1 Point	Score	1 Point	2 Points	3 Points		
			6 : 1					
Penatlity				Penatlity				
C1: C1, C2:				6:1	C1: HC, C2:			
WINNER				Total				

PTS

Decision of Superiority

Judge 1	Judge 2	Judge 3	Judge 4	Judge 5	Judge 6	Judge 7	Referee

Name _____

Signature _____

Lion Cup 2024 Luxembourg

297 Rue de Reckenthal L-2410 Strassen, LUXEMBOURG

Court Nr.	1	Pool	1	Date	2024-06-08	Field Position	61
RED				BLUE			
NOC	BELABASS ZINEB (LUX)			NOC	KESSEL ALEXIA (LUX)		
Category	KUMITE FEMALE U14 -47KG						
3 Points	2 Points	1 Point	Score	1 Point	2 Points	3 Points	
			6 : 0				
Penatlity					Penatlity		
C1: HC, C2:				6:0	C1: , C2:		
WINNER				Total			

PTS

Decision of Superiority

Judge 1	Judge 2	Judge 3	Judge 4	Judge 5	Judge 6	Judge 7	Referee

Name _____

Signature _____

Lion Cup 2024 Luxembourg

297 Rue de Reckenthal L-2410 Strassen, LUXEMBOURG

Court Nr.	1	Pool	1	Date	2024-06-08	Field Position	62
RED				BLUE			
NOC	INTINI RAFFAELLI LARA (LUX)			NOC	VLIELAND KAYLEIGH (NED)		
Category	KUMITE FEMALE U14 -47KG						
3 Points	2 Points	1 Point	Score	1 Point	2 Points	3 Points	
			2 : 5				
Penatlity				Penatlity			
C1: C2, C2:				2:5	C1: , C2:		
				Total	WINNER		

PTS

Decision of Superiority

Judge 1	Judge 2	Judge 3	Judge 4	Judge 5	Judge 6	Judge 7	Referee

Name _____

Signature _____

Lion Cup 2024 Luxembourg

297 Rue de Reckenthal L-2410 Strassen, LUXEMBOURG

Court Nr.	1	Pool	1	Date	2024-06-08	Field Position	63
RED				BLUE			
NOC	BELABASS ZINEB (LUX)			NOC	VLIELAND KAYLEIGH (NED)		
Category	KUMITE FEMALE U14 -47KG						
3 Points	2 Points	1 Point	Score	1 Point	2 Points	3 Points	
			1 : 8				
Penatlity				Penatlity			
C1: , C2:				1:8	C1: HC, C2:		
				Total	WINNER		

PTS

Decision of Superiority

Judge 1	Judge 2	Judge 3	Judge 4	Judge 5	Judge 6	Judge 7	Referee

Name _____

Signature _____

Lion Cup 2024 Luxembourg

297 Rue de Reckenthal L-2410 Strassen, LUXEMBOURG

Court Nr.	1	Pool	1	Date	2024-06-08	Field Position	0
RED				BLUE			
NOC	NF SYLVIE (SUI)			NOC	KESSEL ALEXIA (LUX)		
Category	KUMITE FEMALE U14 -47KG						
3 Points	2 Points	1 Point	Score	1 Point	2 Points	3 Points	
			8 : 0				
Penatlity				Penatlity			
C1: , C2:				8:0	C1: , C2:		
WINNER				Total			

PTS

Decision of Superiority

Judge 1	Judge 2	Judge 3	Judge 4	Judge 5	Judge 6	Judge 7	Referee

Name _____

Signature _____

Lion Cup 2024 Luxembourg

297 Rue de Reckenthal L-2410 Strassen, LUXEMBOURG

Court Nr.	1	Pool	1	Date	2024-06-08	Field Position	2
RED				BLUE			
NOC	KURTALIC SHERAZAD (BEL)			NOC	NF SYLVIE (SUI)		
Category	KUMITE FEMALE U14 -47KG						
3 Points	2 Points	1 Point	Score	1 Point	2 Points	3 Points	
			:				
Penatlity				Penatlity			
			Total				

Decision of Superiority

Judge 1	Judge 2	Judge 3	Judge 4	Judge 5	Judge 6	Judge 7	Referee

Name _____

Signature _____

Lion Cup 2024 Luxembourg

297 Rue de Reckenthal L-2410 Strassen, LUXEMBOURG

Court Nr.	2	Pool	2	Date	2024-06-08	Field Position	0	
RED				BLUE				
NOC	GUETARI YAKIN (BEL)			NOC	INTINI RAFFAELLI LARA (LUX)			
Category	KUMITE FEMALE U14 -47KG							
3 Points	2 Points	1 Point	Score	1 Point	2 Points	3 Points		
			3 : 0					
Penatlity				Penatlity				
C1: C3, C2:				3:0	C1: C1, C2:			
WINNER				Total				

PTS

Decision of Superiority

Judge 1	Judge 2	Judge 3	Judge 4	Judge 5	Judge 6	Judge 7	Referee

Name _____

Signature _____

Lion Cup 2024 Luxembourg

297 Rue de Reckenthal L-2410 Strassen, LUXEMBOURG

Court Nr.	2	Pool	2	Date	2024-06-08	Field Position	2
RED				BLUE			
NOC	NGI NAYA (SUI)			NOC	GUETARI YAKIN (BEL)		
Category	KUMITE FEMALE U14 -47KG						
3 Points	2 Points	1 Point	Score	1 Point	2 Points	3 Points	
			2 : 2				
Penatlity				Penatlity			
C1: , C2:				2:2	C1: C1, C2:		
				Total	WINNER		

PTS

Decision of Superiority

Judge 1	Judge 2	Judge 3	Judge 4	Judge 5	Judge 6	Judge 7	Referee

Name _____

Signature _____

Official Results

KUMITE FEMALE U14 -47KG			
1	VLIELAND KAYLEIGH		NED - NETHERLANDS
2	BELABASS ZINEB		LUX - LUXEMBOURG
3	NÄF SYLVIE		SUI - SWITZERLAND
3	GUETARI YAKIN		BEL - BELGIUM
5	KESSEL ALEXIA		LUX - LUXEMBOURG
5	INTINI RAFFAELLI LARA		LUX - LUXEMBOURG
7	KURTALIC SHERAZAD		BEL - BELGIUM
7	GNÄGI NAYA		SUI - SWITZERLAND

KUMITE FEMALE U14 -52KG

Lion Cup 2024 Luxembourg

ENTRIES BY WEIGHT CATEGORY
KUMITE FEMALE U14 -52KG

As of 8 JUN 2024

NOC Code	Gender	Name	Seeding
BEL	F	Poskin Emilie	
FRA	F	Tchaldaev Gayna	
GER	F	Becker Celine	
GER	F	Mohammad Rouhaiv	
LUX	F	Durrer Nahima	
LUX	F	Rosa Maelys	
NED	F	Keulen van Norah	
NED	F	van Bommel Ise	
SUI	F	Sigillò Anastasia	

KUMITE FEMALE U14 -52KG

Lion Cup 2024 Luxembourg, 297 Rue de Reckenthal L-2410 Strassen, LUX

2024-06-08

Tatami
5 14:10

Pool
1/1

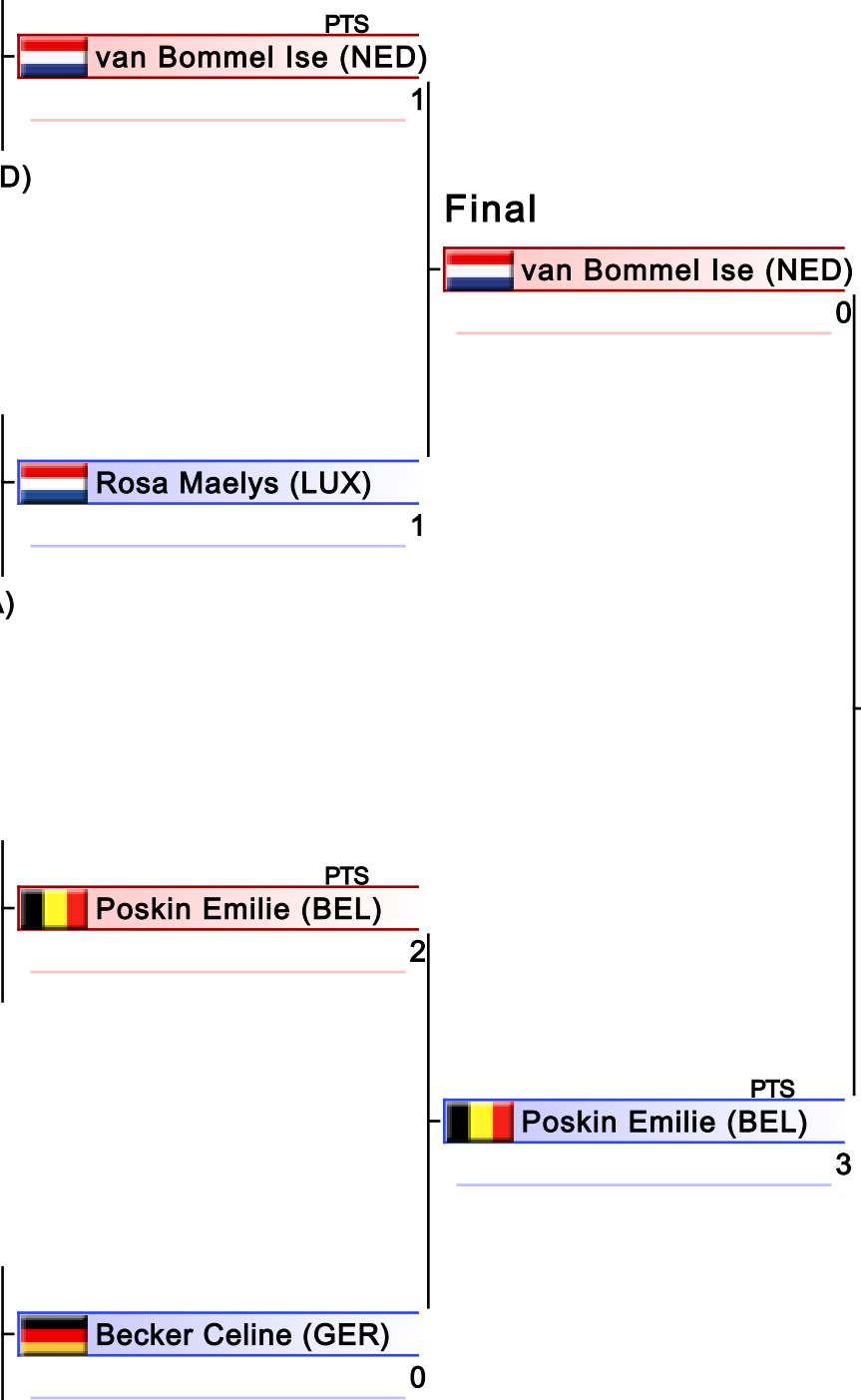
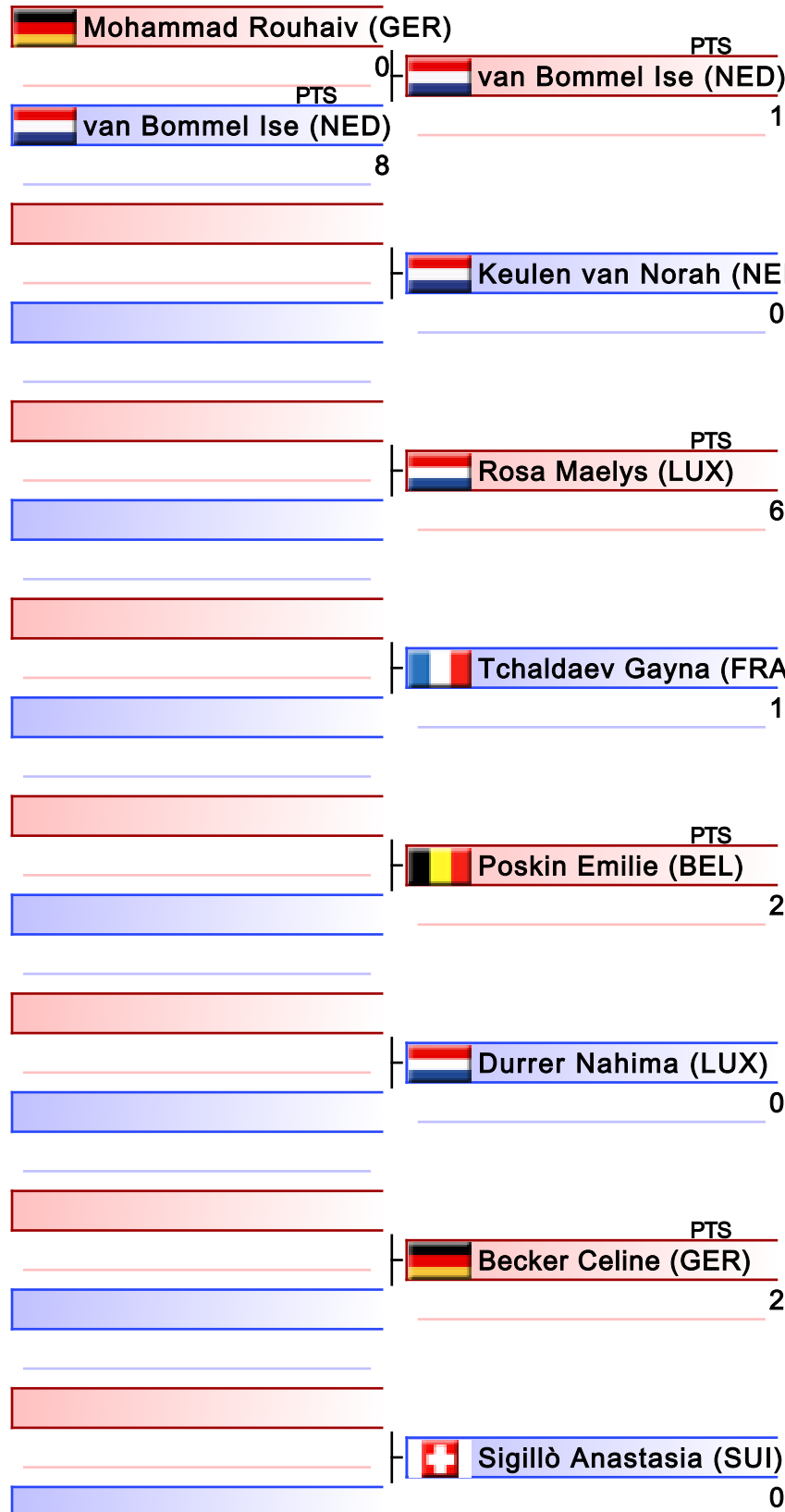

1. POSKIN EMILIE (BEL)
2. VAN BOMMEL ISE (NED)
3. BECKER CELINE (GER)
3. ROSA MAELYS (LUX)
5. DURRER NAHIMA (LUX)
5. KEULEN VAN NORAH (NED)
7. MOHAMMAD ROUHAIV (GER)

KUMITE FEMALE U14 -52KG

Lion Cup 2024 Luxembourg

2024-06-08

Tatami
5 14:35

Pool
1

(c)sportdata GmbH & Co KG 2000-2024 (2024-06-08 18:41) v 10.1.0 build 1 (2024-01-24 23:23 CET) License: Online_Event_ID-7672_LionCup2024Luxembourg (expire 2024-06-21)

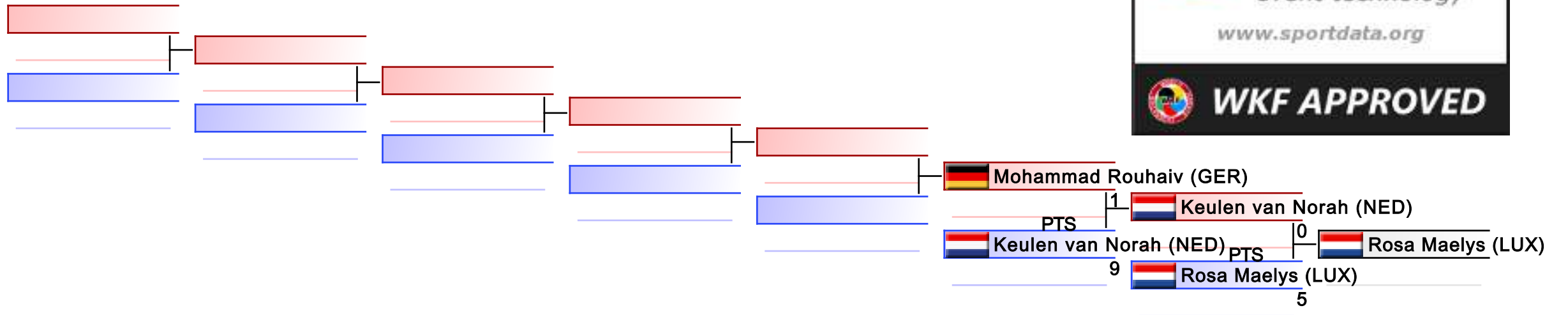

REPECHAGE: (1)

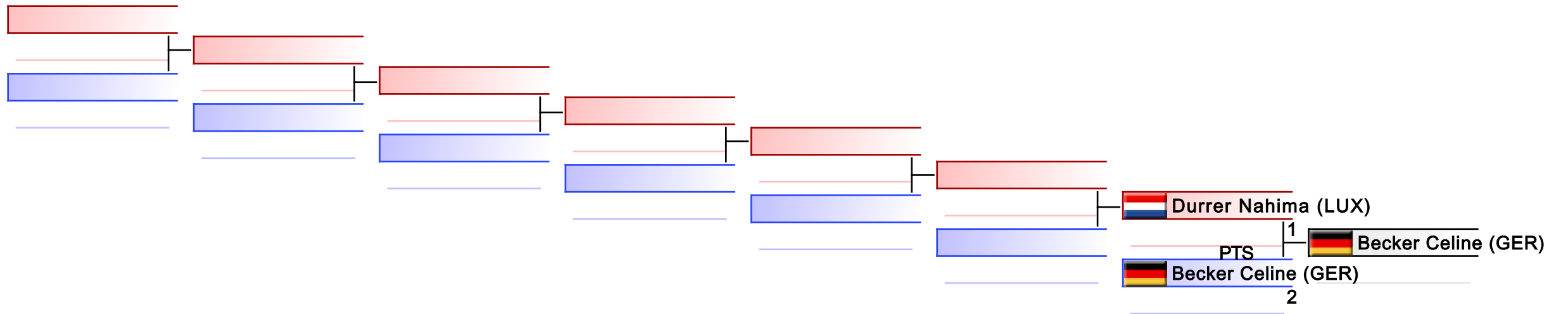

Lion Cup 2024 Luxembourg

297 Rue de Reckenthal L-2410 Strassen, LUXEMBOURG

Court Nr.	1	Pool	1	Date	2024-06-08	Field Position	49
RED				BLUE			
NOC	MOHAMMAD ROUHAIV (GER)			NOC	VAN BOMMEL ISE (NED)		
Category	KUMITE FEMALE U14 -52KG						
3 Points	2 Points	1 Point	Score	1 Point	2 Points	3 Points	
			0 : 8				
Penatlity				Penatlity			
C1: , C2:				0:8	C1: C1, C2:		
				Total	WINNER		

PTS

Decision of Superiority

Judge 1	Judge 2	Judge 3	Judge 4	Judge 5	Judge 6	Judge 7	Referee

Name _____

Signature _____

Lion Cup 2024 Luxembourg

297 Rue de Reckenthal L-2410 Strassen, LUXEMBOURG

Court Nr.	1	Pool	1	Date	2024-06-08	Field Position	57
RED				BLUE			
NOC	VAN BOMMEL ISE (NED)			NOC	KEULEN VAN NORAH (NED)		
Category	KUMITE FEMALE U14 -52KG						
3 Points	2 Points	1 Point	Score	1 Point	2 Points	3 Points	
			1 : 0				
Penatlity				Penatlity			
C1: HC, C2:				1:0	C1: , C2:		
WINNER				Total			

PTS

Decision of Superiority

Judge 1	Judge 2	Judge 3	Judge 4	Judge 5	Judge 6	Judge 7	Referee

Name _____

Signature _____

Lion Cup 2024 Luxembourg

297 Rue de Reckenthal L-2410 Strassen, LUXEMBOURG

Court Nr.	1	Pool	1	Date	2024-06-08	Field Position	58
RED				BLUE			
NOC	ROSA MAELYS (LUX)			NOC	TCHALDAEV GAYNA (FRA)		
Category	KUMITE FEMALE U14 -52KG						
3 Points	2 Points	1 Point	Score	1 Point	2 Points	3 Points	
			6 : 1				
Penatlity					Penatlity		
C1: , C2:				6:1	C1: C1, C2:		
WINNER				Total			

PTS

Decision of Superiority

Judge 1	Judge 2	Judge 3	Judge 4	Judge 5	Judge 6	Judge 7	Referee

Name _____

Signature _____

Lion Cup 2024 Luxembourg

297 Rue de Reckenthal L-2410 Strassen, LUXEMBOURG

Court Nr.	1	Pool	1	Date	2024-06-08	Field Position	59
RED				BLUE			
NOC	POSKIN EMILIE (BEL)			NOC	DURRER NAHIMA (LUX)		
Category	KUMITE FEMALE U14 -52KG						
3 Points	2 Points	1 Point	Score	1 Point	2 Points	3 Points	
			2 : 0				
Penatlity				Penatlity			
C1: , C2:			2:0	C1: , C2:			
WINNER			Total				

PTS

Decision of Superiority

Judge 1	Judge 2	Judge 3	Judge 4	Judge 5	Judge 6	Judge 7	Referee

Name _____

Signature _____

Lion Cup 2024 Luxembourg

297 Rue de Reckenthal L-2410 Strassen, LUXEMBOURG

Court Nr.	1	Pool	1	Date	2024-06-08	Field Position	60
RED				BLUE			
NOC	BECKER CELINE (GER)			NOC	SIGILL ANASTASIA (SUI)		
Category	KUMITE FEMALE U14 -52KG						
3 Points	2 Points	1 Point	Score	1 Point	2 Points	3 Points	
			2 : 0				
Penatlity				Penatlity			
C1: HC, C2:			2:0	C1: , C2:			
WINNER			Total				

PTS

Decision of Superiority

Judge 1	Judge 2	Judge 3	Judge 4	Judge 5	Judge 6	Judge 7	Referee

Name _____

Signature _____

Lion Cup 2024 Luxembourg

297 Rue de Reckenthal L-2410 Strassen, LUXEMBOURG

Court Nr.	1	Pool	1	Date	2024-06-08	Field Position	61
RED				BLUE			
NOC	VAN BOMMEL ISE (NED)			NOC	ROSA MAELYS (LUX)		
Category	KUMITE FEMALE U14 -52KG						
3 Points	2 Points	1 Point	Score	1 Point	2 Points	3 Points	
			1 : 1				
Penatlity				Penatlity			
C1: C1, C2:				1:1	C1: C2, C2:		
WINNER				Total			

PTS

Decision of Superiority

Judge 1	Judge 2	Judge 3	Judge 4	Judge 5	Judge 6	Judge 7	Referee

Name _____

Signature _____

Lion Cup 2024 Luxembourg

297 Rue de Reckenthal L-2410 Strassen, LUXEMBOURG

Court Nr.	1	Pool	1	Date	2024-06-08	Field Position	62
RED				BLUE			
NOC	POSKIN EMILIE (BEL)			NOC	BECKER CELINE (GER)		
Category	KUMITE FEMALE U14 -52KG						
3 Points	2 Points	1 Point	Score	1 Point	2 Points	3 Points	
			2 : 0				
Penatlity				Penatlity			
C1: HC, C2:			2:0	C1: C1, C2:			
WINNER			Total				

PTS

Decision of Superiority

Judge 1	Judge 2	Judge 3	Judge 4	Judge 5	Judge 6	Judge 7	Referee

Name _____

Signature _____

Lion Cup 2024 Luxembourg

297 Rue de Reckenthal L-2410 Strassen, LUXEMBOURG

Court Nr.	1	Pool	1	Date	2024-06-08	Field Position	63
RED				BLUE			
NOC	VAN BOMMEL ISE (NED)			NOC	POSKIN EMILIE (BEL)		
Category	KUMITE FEMALE U14 -52KG						
3 Points	2 Points	1 Point	Score	1 Point	2 Points	3 Points	
			0 : 3				
Penatlity				Penatlity			
C1: , C2:				0:3	C1: , C2:		
				Total	WINNER		

PTS

Decision of Superiority

Judge 1	Judge 2	Judge 3	Judge 4	Judge 5	Judge 6	Judge 7	Referee

Name _____

Signature _____

Lion Cup 2024 Luxembourg

297 Rue de Reckenthal L-2410 Strassen, LUXEMBOURG

Court Nr.	1	Pool	1	Date	2024-06-08	Field Position	0
RED				BLUE			
NOC	KEULEN VAN NORAH (NED)			NOC	ROSA MAELYS (LUX)		
Category	KUMITE FEMALE U14 -52KG						
3 Points	2 Points	1 Point	Score	1 Point	2 Points	3 Points	
			0 : 5				
Penatlity				Penatlity			
C1: , C2:				0:5	C1: C2, C2:		
				Total	WINNER		

PTS

Decision of Superiority

Judge 1	Judge 2	Judge 3	Judge 4	Judge 5	Judge 6	Judge 7	Referee

Name _____

Signature _____

Lion Cup 2024 Luxembourg

297 Rue de Reckenthal L-2410 Strassen, LUXEMBOURG

Court Nr.	1	Pool	1	Date	2024-06-08	Field Position	2
RED				BLUE			
NOC	MOHAMMAD ROUHAIV (GER)			NOC	KEULEN VAN NORAH (NED)		
Category	KUMITE FEMALE U14 -52KG						
3 Points	2 Points	1 Point	Score	1 Point	2 Points	3 Points	
			:				
Penatlity				Penatlity			
			Total				

Decision of Superiority

Judge 1	Judge 2	Judge 3	Judge 4	Judge 5	Judge 6	Judge 7	Referee

Name _____

Signature _____

Lion Cup 2024 Luxembourg

297 Rue de Reckenthal L-2410 Strassen, LUXEMBOURG

Court Nr.	2	Pool	2	Date	2024-06-08	Field Position	0
RED				BLUE			
NOC	DURRER NAHIMA (LUX)			NOC	BECKER CELINE (GER)		
Category	KUMITE FEMALE U14 -52KG						
3 Points	2 Points	1 Point	Score	1 Point	2 Points	3 Points	
			1 : 2				
Penatlity				Penatlity			
C1: , C2:			1:2	C1: , C2:			
			Total	WINNER			

PTS

Decision of Superiority

Judge 1	Judge 2	Judge 3	Judge 4	Judge 5	Judge 6	Judge 7	Referee

Name _____

Signature _____

Official Results

KUMITE FEMALE U14 -52KG			
1	POSKIN EMILIE		BEL - BELGIUM
2	VAN BOMMEL ISE		NED - NETHERLANDS
3	BECKER CELINE		GER - GERMANY
3	ROSA MAELYS		LUX - LUXEMBOURG
5	DURRER NAHIMA		LUX - LUXEMBOURG
5	KEULEN VAN NORAH		NED - NETHERLANDS
7	MOHAMMAD ROUHAIV		GER - GERMANY

KUMITE FEMALE U18 +66KG

Lion Cup 2024 Luxembourg

ENTRIES BY WEIGHT CATEGORY
KUMITE FEMALE U18 +66kg









As of 8 JUN 2024

NOC Code	Gender	Name	Seeding
NED	F	Hout van Liz	
NED	F	Zwanenburg Robin	
TUN	F	Ettaleb Meriame	

KUMITE FEMALE U18 +66kg - Round Robin (each against each)

Lion Cup 2024 Luxembourg, 297 Rue de Reckenthal L-2410 Strassen, LUX

2024-06-08 Tatami 4 10:05 Pool 1/1

- 1  Hout van Liz (NED)  Hout van Liz (NED)
- 2  Ettaleb Meriame (TUN)
- 3  Hout van Liz (NED) 2  Zwanenburg Robin (NED)
- 4  Zwanenburg Robin (NED) 2
- 5  Ettaleb Meriame (TUN)  Zwanenburg Robin (NED)
- 6  Zwanenburg Robin (NED)



1. ZWANENBURG ROBIN (NED)
2. HOUT VAN LIZ (NED)

Lion Cup 2024 Luxembourg

297 Rue de Reckenthal L-2410 Strassen, LUXEMBOURG

Court Nr.	1	Pool	1	Date	2024-06-08	Field Position	-9950
RED				BLUE			
NOC	HOUT VAN LIZ (NED)			NOC	ZWANENBURG ROBIN (NED)		
Category	KUMITE FEMALE U18 +66kg						
3 Points	2 Points	1 Point	Score	1 Point	2 Points	3 Points	
			2 : 2				
Penatlity				Penatlity			
C1: C1, C2:			2:2	C1: C1, C2:			
			Total	WINNER			

Decision of Superiority



Judge 1	Judge 2	Judge 3	Judge 4	Judge 5	Judge 6	Judge 7	Referee

Name _____

Signature _____

Lion Cup 2024 Luxembourg - 2024-06-07

Official Results

KUMITE FEMALE U18 +66kg			
1	ZWANENBURG ROBIN		NED - NETHERLANDS
2	HOUT VAN LIZ		NED - NETHERLANDS

KUMITE FEMALE U18 -66KG

Lion Cup 2024 Luxembourg

ENTRIES BY WEIGHT CATEGORY
KUMITE FEMALE U18 -66KG

As of 8 JUN 2024

NOC Code	Gender	Name	Seeding
FIN	F	Kirov Vanessa	
FIN	F	Saadaoui Sonya	
LUX	F	Theisen Monique	
NED	F	Rozenblad Adriana M A	
NED	F	Valk Imane	
SUI	F	Caluori Svenja	
SUI	F	Staub Nia	
SWE	F	Jakesevic Ivana	

KUMITE FEMALE U18 -66KG

Lion Cup 2024 Luxembourg, 297 Rue de Reckenthal L-2410 Strassen, LUX

2024-06-08

Tatami
3 11:05

Pool
1 / 1

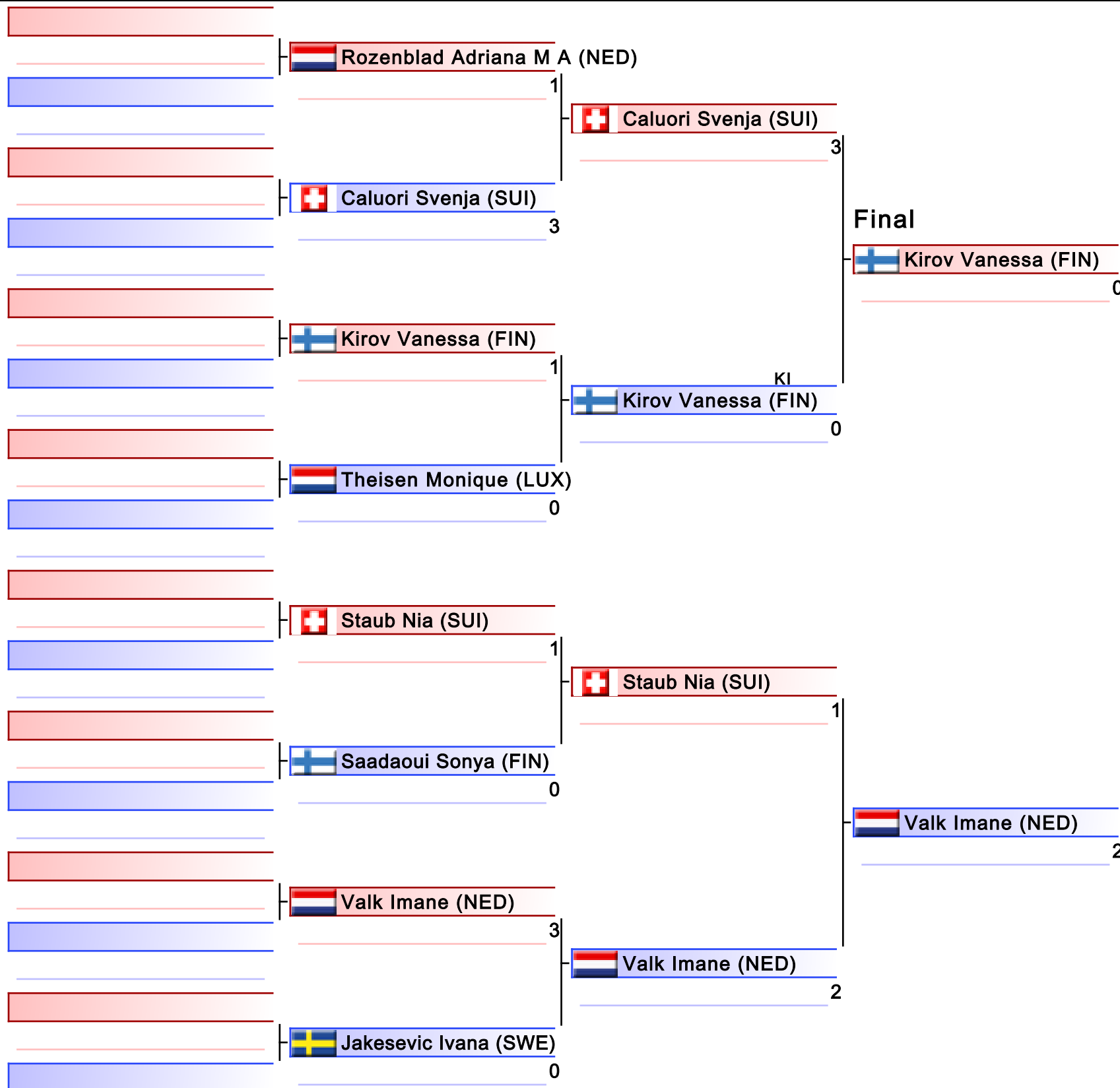

Valk Imane (NED)

1. VALK IMANE (NED)
2. KIROV VANESSA (FIN)
3. THEISEN MONIQUE (LUX)
3. JAKESEVIC IVANA (SWE)
5. CALUORI SVENJA (SUI)
5. STAUB NIA (SUI)

KUMITE FEMALE U18 -66KG

Lion Cup 2024 Luxembourg

2024-06-08

Tatami
3 11:35

Pool
1

(c)sportdata GmbH & Co KG 2000-2024 (2024-06-08 18:41) v 10.1.0 build 1 (2024-01-24 23:23 CET) License: Online_Event_ID-7672_LionCup2024Luxembourg (expire 2024-06-21)

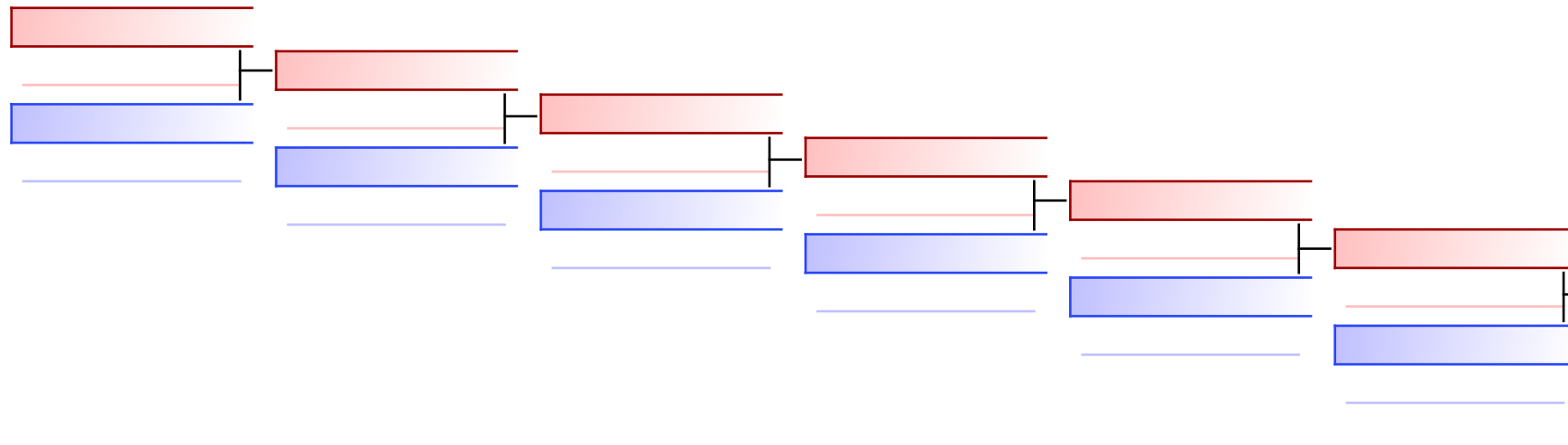

KI

Theisen Monique (LUX)	0	Theisen Monique (LUX)
Caluori Svenja (SUI)	0	

REPECHAGE: (1)

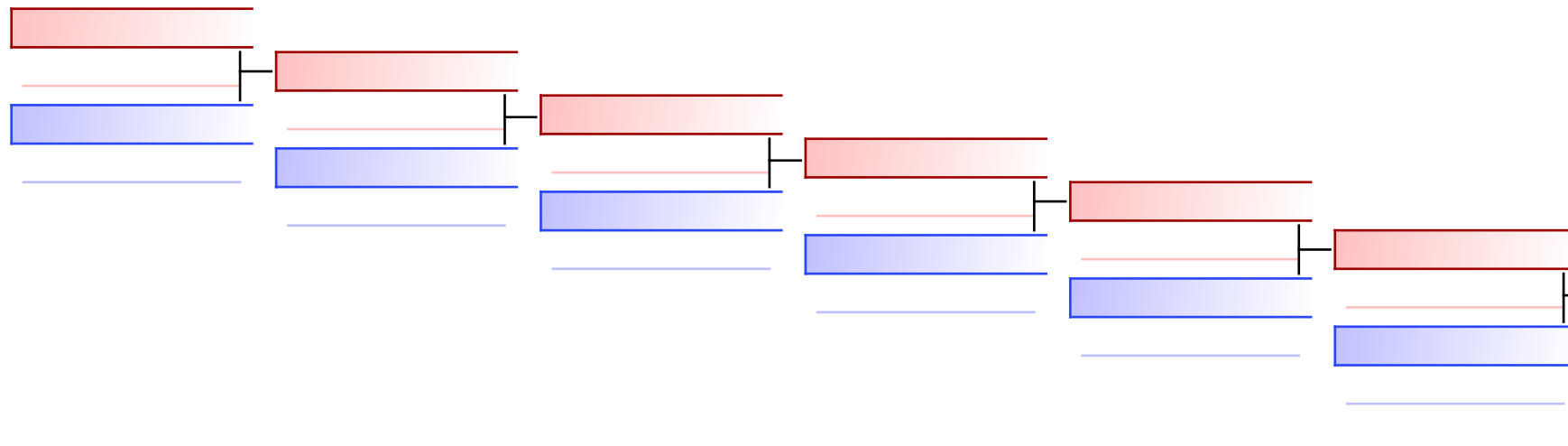

Jakešević Ivana (SWE)	1	Jakešević Ivana (SWE)
Staub Nia (SUI)	0	

Lion Cup 2024 Luxembourg

297 Rue de Reckenthal L-2410 Strassen, LUXEMBOURG

Court Nr.	1	Pool	1	Date	2024-06-08	Field Position	57	
RED				BLUE				
NOC	ROZENBLAD ADRIANA M A (NED)			NOC	CALUORI SVENJA (SUI)			
Category	KUMITE FEMALE U18 -66KG							
3 Points	2 Points	1 Point	Score	1 Point	2 Points	3 Points		
			1 : 3					
Penatlity				Penatlity				
C1: HC, C2:				1:3	C1: HC, C2:			
				Total	WINNER			

Decision of Superiority

Judge 1	Judge 2	Judge 3	Judge 4	Judge 5	Judge 6	Judge 7	Referee

Name _____

Signature _____

Lion Cup 2024 Luxembourg

297 Rue de Reckenthal L-2410 Strassen, LUXEMBOURG

Court Nr.	1	Pool	1	Date	2024-06-08	Field Position	58
RED				BLUE			
NOC	KIROV VANESSA (FIN)			NOC	THEISEN MONIQUE (LUX)		
Category	KUMITE FEMALE U18 -66KG						
3 Points	2 Points	1 Point	Score	1 Point	2 Points	3 Points	
			1 : 0				
Penatlity				Penatlity			
C1: C2, C2:				1:0	C1: C1, C2:		
WINNER				Total			

Decision of Superiority

Judge 1	Judge 2	Judge 3	Judge 4	Judge 5	Judge 6	Judge 7	Referee

Name _____

Signature _____

Lion Cup 2024 Luxembourg

297 Rue de Reckenthal L-2410 Strassen, LUXEMBOURG

Court Nr.	1	Pool	1	Date	2024-06-08	Field Position	59
RED				BLUE			
NOC	STAUB NIA (SUI)			NOC	SAADAOUI SONYA (FIN)		
Category	KUMITE FEMALE U18 -66KG						
3 Points	2 Points	1 Point	Score	1 Point	2 Points	3 Points	
			1 : 0				
Penatlity				Penatlity			
C1: HC, C2:				1:0	C1: , C2:		
WINNER				Total			

Decision of Superiority

Judge 1	Judge 2	Judge 3	Judge 4	Judge 5	Judge 6	Judge 7	Referee

Name _____

Signature _____

Lion Cup 2024 Luxembourg

297 Rue de Reckenthal L-2410 Strassen, LUXEMBOURG

Court Nr.	1	Pool	1	Date	2024-06-08	Field Position	60
RED				BLUE			
NOC	VALK IMANE (NED)			NOC	JAKESEVIC IVANA (SWE)		
Category	KUMITE FEMALE U18 -66KG						
3 Points	2 Points	1 Point	Score	1 Point	2 Points	3 Points	
			3 : 0				
Penatlity				Penatlity			
C1: C1, C2:				3:0	C1: C3, C2:		
WINNER				Total			

Decision of Superiority

Judge 1	Judge 2	Judge 3	Judge 4	Judge 5	Judge 6	Judge 7	Referee

Name _____

Signature _____

Lion Cup 2024 Luxembourg

297 Rue de Reckenthal L-2410 Strassen, LUXEMBOURG

Court Nr.	1	Pool	1	Date	2024-06-08	Field Position	61
RED				BLUE			
NOC	CALUORI SVENJA (SUI)			NOC	KIROV VANESSA (FIN)		
Category	KUMITE FEMALE U18 -66KG						
3 Points	2 Points	1 Point	Score	1 Point	2 Points	3 Points	
			3 : 0				
Penatlity				Penatlity			
C1: C1, C2:				3:0	C1: C1, C2:		
				Total	WINNER		

KI

Decision of Superiority

Judge 1	Judge 2	Judge 3	Judge 4	Judge 5	Judge 6	Judge 7	Referee

Name _____

Signature _____

Lion Cup 2024 Luxembourg

297 Rue de Reckenthal L-2410 Strassen, LUXEMBOURG

Court Nr.	1	Pool	1	Date	2024-06-08	Field Position	62
RED				BLUE			
NOC	STAUB NIA (SUI)			NOC	VALK IMANE (NED)		
Category	KUMITE FEMALE U18 -66KG						
3 Points	2 Points	1 Point	Score	1 Point	2 Points	3 Points	
			1 : 2				
Penatlity					Penatlity		
C1: C1, C2:				1:2	C1: C2, C2:		
				Total	WINNER		

Decision of Superiority

Judge 1	Judge 2	Judge 3	Judge 4	Judge 5	Judge 6	Judge 7	Referee

Name _____

Signature _____

Lion Cup 2024 Luxembourg

297 Rue de Reckenthal L-2410 Strassen, LUXEMBOURG

Court Nr.	1	Pool	1	Date	2024-06-08	Field Position	63	
RED				BLUE				
NOC	KIROV VANESSA (FIN)			NOC	VALK IMANE (NED)			
Category	KUMITE FEMALE U18 -66KG							
3 Points	2 Points	1 Point	Score	1 Point	2 Points	3 Points		
			0 : 2					
Penatlity				Penatlity				
C1: HC, C2:				0:2	C1: HC, C2:			
				Total	WINNER			

Decision of Superiority

Judge 1	Judge 2	Judge 3	Judge 4	Judge 5	Judge 6	Judge 7	Referee

Name _____

Signature _____

Lion Cup 2024 Luxembourg

297 Rue de Reckenthal L-2410 Strassen, LUXEMBOURG

Court Nr.	1	Pool	1	Date	2024-06-08	Field Position	0
RED				BLUE			
NOC	THEISEN MONIQUE (LUX)			NOC	CALUORI SVENJA (SUI)		
Category	KUMITE FEMALE U18 -66KG						
3 Points	2 Points	1 Point	Score	1 Point	2 Points	3 Points	
			:				
Penatlity				Penatlity			
			Total				

Decision of Superiority

Judge 1	Judge 2	Judge 3	Judge 4	Judge 5	Judge 6	Judge 7	Referee

Name _____

Signature _____

Lion Cup 2024 Luxembourg

297 Rue de Reckenthal L-2410 Strassen, LUXEMBOURG

Court Nr.	2	Pool	2	Date	2024-06-08	Field Position	0
RED				BLUE			
NOC	JAKESEVIC IVANA (SWE)			NOC	STAUB NIA (SUI)		
Category	KUMITE FEMALE U18 -66KG						
3 Points	2 Points	1 Point	Score	1 Point	2 Points	3 Points	
			1 : 0				
Penatlity					Penatlity		
C1: C1, C2:				1:0	C1: C2, C2:		
WINNER				Total			

Decision of Superiority

Judge 1	Judge 2	Judge 3	Judge 4	Judge 5	Judge 6	Judge 7	Referee

Name _____

Signature _____

Official Results

KUMITE FEMALE U18 -66KG			
1	VALK IMANE		NED - NETHERLANDS
2	KIROV VANESSA		FIN - FINLAND
3	THEISEN MONIQUE		LUX - LUXEMBOURG
3	JAKESEVIC IVANA		SWE - SWEDEN
5	CALUORI SVENJA		SUI - SWITZERLAND
5	STAUB NIA		SUI - SWITZERLAND

KUMITE MALE U14 -45KG_

Lion Cup 2024 Luxembourg

ENTRIES BY WEIGHT CATEGORY
KUMITE MALE U14 -45kg_

As of 8 JUN 2024

NOC Code	Gender	Name	Seeding
BEL	M	es-salehy ismail	
BEL	M	Ferrari Samuel	
BEL	M	STIRBU David	
LUX	M	Cohen sabban Timothee	
LUX	M	Pang Jason	
LUX	M	Yildirm Ali	
NED	M	Enthoven Scott	
NED	M	Essers Reinier	
NED	M	Peschier Kyanu	
NED	M	Werner Ruben	
SUI	M	Battistel Florin	
SUI	M	Solomon Merih	

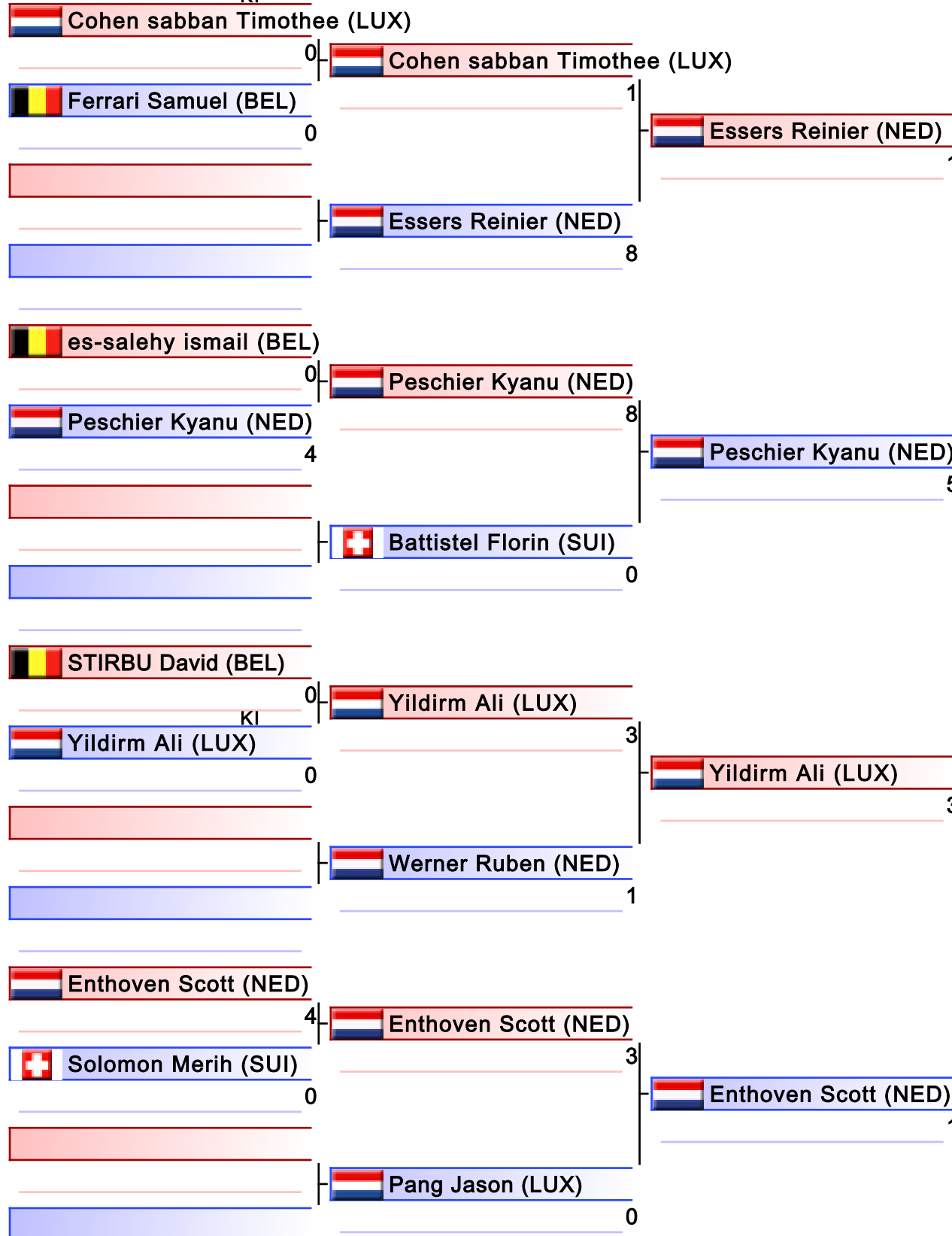

Final

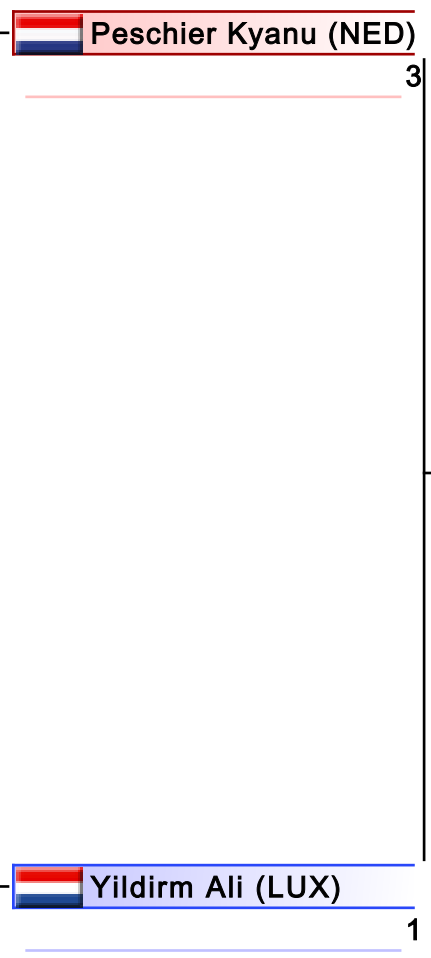

Peschier Kyanu (NED)

1. PESCHIER KYANU (NED)
2. YILDIRM ALI (LUX)
3. ENTHOVEN SCOTT (NED)
3. ESSERS REINIER (NED)
5. WERNER RUBEN (NED)
5. ES-SALEHY ISMAIL (BEL)
7. STIRBU DAVID (BEL)
7. BATTISTEL FLORIN (SUI)

KUMITE MALE U14 -45kg_

Lion Cup 2024 Luxembourg

2024-06-08

Tatami
3 15:25

Pool
1

(c)sportdata GmbH & Co KG 2000-2024 (2024-06-08 18:41) v 10.1.0 build 1 (2024-01-24 23:23 CET) License: Online_Event_ID-7672_LionCup2024Luxembourg (expire 2024-06-21)

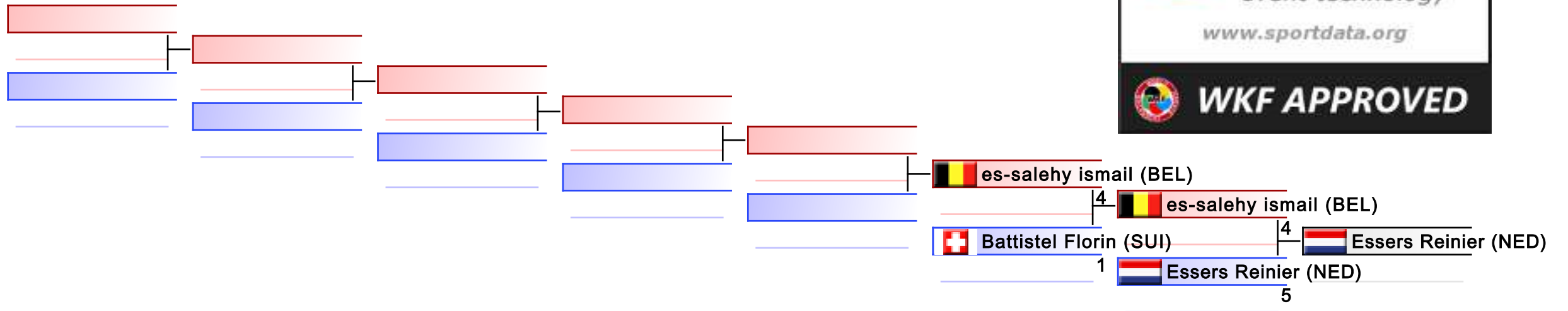

REPECHAGE: (1)

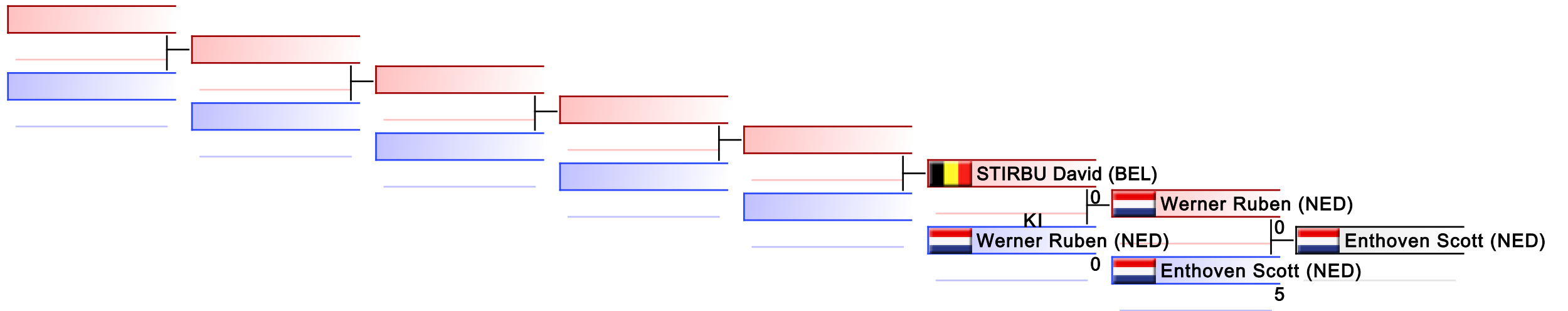

Lion Cup 2024 Luxembourg

297 Rue de Reckenthal L-2410 Strassen, LUXEMBOURG

Court Nr.	1	Pool	1	Date	2024-06-08	Field Position	49
RED				BLUE			
NOC	COHEN SABBAN TIMOTHEE (LUX)			NOC	FERRARI SAMUEL (BEL)		
Category	KUMITE MALE U14 -45kg_						
3 Points	2 Points	1 Point	Score	1 Point	2 Points	3 Points	
			0 : 0				
Penatlity				Penatlity			
C1: , C2:				0:0	C1: , C2:		
WINNER				Total			

KI

Decision of Superiority

Judge 1	Judge 2	Judge 3	Judge 4	Judge 5	Judge 6	Judge 7	Referee

Name _____

Signature _____

Lion Cup 2024 Luxembourg

297 Rue de Reckenthal L-2410 Strassen, LUXEMBOURG

Court Nr.	1	Pool	1	Date	2024-06-08	Field Position	51
RED				BLUE			
NOC	ES-SALEHY ISMAIL (BEL)			NOC	PESCHIER KYANU (NED)		
Category	KUMITE MALE U14 -45kg_						
3 Points	2 Points	1 Point	Score	1 Point	2 Points	3 Points	
			0 : 4				
Penatlity					Penatlity		
C1: C2, C2:				0:4	C1: HC, C2:		
				Total	WINNER		

Decision of Superiority

Judge 1	Judge 2	Judge 3	Judge 4	Judge 5	Judge 6	Judge 7	Referee

Name _____

Signature _____

Lion Cup 2024 Luxembourg

297 Rue de Reckenthal L-2410 Strassen, LUXEMBOURG

Court Nr.	1	Pool	1	Date	2024-06-08	Field Position	53
RED				BLUE			
NOC	STIRBU DAVID (BEL)			NOC	YILDIRM ALI (LUX)		
Category	KUMITE MALE U14 -45kg_						
3 Points	2 Points	1 Point	Score	1 Point	2 Points	3 Points	
			0 : 0				
Penatlity				Penatlity			
C1: , C2:				0:0	C1: , C2:		
				Total	WINNER		

KI

Decision of Superiority

Judge 1	Judge 2	Judge 3	Judge 4	Judge 5	Judge 6	Judge 7	Referee

Name _____

Signature _____

Lion Cup 2024 Luxembourg

297 Rue de Reckenthal L-2410 Strassen, LUXEMBOURG

Court Nr.	1	Pool	1	Date	2024-06-08	Field Position	55	
RED				BLUE				
NOC	ENTHOVEN SCOTT (NED)			NOC	SOLOMON MERIH (SUI)			
Category	KUMITE MALE U14 -45kg_							
3 Points	2 Points	1 Point	Score	1 Point	2 Points	3 Points		
			4 : 0					
Penatlity				Penatlity				
C1: , C2:				4:0	C1: , C2:			
WINNER				Total				

Decision of Superiority

Judge 1	Judge 2	Judge 3	Judge 4	Judge 5	Judge 6	Judge 7	Referee

Name _____

Signature _____

Lion Cup 2024 Luxembourg

297 Rue de Reckenthal L-2410 Strassen, LUXEMBOURG

Court Nr.	1	Pool	1	Date	2024-06-08	Field Position	57	
RED				BLUE				
NOC	COHEN SABBAN TIMOTHEE (LUX)			NOC	ESSERS REINIER (NED)			
Category	KUMITE MALE U14 -45kg_							
3 Points	2 Points	1 Point	Score	1 Point	2 Points	3 Points		
			1 : 8					
Penatlity				Penatlity				
C1: HC, C2:				1:8	C1: C3, C2:			
				Total	WINNER			

Decision of Superiority

Judge 1	Judge 2	Judge 3	Judge 4	Judge 5	Judge 6	Judge 7	Referee

Name _____

Signature _____

Lion Cup 2024 Luxembourg

297 Rue de Reckenthal L-2410 Strassen, LUXEMBOURG

Court Nr.	1	Pool	1	Date	2024-06-08	Field Position	58	
RED				BLUE				
NOC	PESCHIER KYANU (NED)			NOC	BATTISTEL FLORIN (SUI)			
Category	KUMITE MALE U14 -45kg_							
3 Points	2 Points	1 Point	Score	1 Point	2 Points	3 Points		
			8 : 0					
Penatlity				Penatlity				
C1: , C2:				8:0	C1: C2, C2:			
WINNER				Total				

Decision of Superiority

Judge 1	Judge 2	Judge 3	Judge 4	Judge 5	Judge 6	Judge 7	Referee

Name _____

Signature _____

Lion Cup 2024 Luxembourg

297 Rue de Reckenthal L-2410 Strassen, LUXEMBOURG

Court Nr.	1	Pool	1	Date	2024-06-08	Field Position	59
RED				BLUE			
NOC	YILDIRM ALI (LUX)			NOC	WERNER RUBEN (NED)		
Category	KUMITE MALE U14 -45kg_						
3 Points	2 Points	1 Point	Score	1 Point	2 Points	3 Points	
			3 : 1				
Penatlity				Penatlity			
C1: , C2:				3:1	C1: , C2:		
WINNER				Total			

Decision of Superiority

Judge 1	Judge 2	Judge 3	Judge 4	Judge 5	Judge 6	Judge 7	Referee

Name _____

Signature _____

Lion Cup 2024 Luxembourg

297 Rue de Reckenthal L-2410 Strassen, LUXEMBOURG

Court Nr.	1	Pool	1	Date	2024-06-08	Field Position	60
RED				BLUE			
NOC	ENTHOVEN SCOTT (NED)			NOC	PANG JASON (LUX)		
Category	KUMITE MALE U14 -45kg_						
3 Points	2 Points	1 Point	Score	1 Point	2 Points	3 Points	
			3 : 0				
Penatlity				Penatlity			
C1: C1, C2:				3:0	C1: C1, C2:		
WINNER				Total			

Decision of Superiority

Judge 1	Judge 2	Judge 3	Judge 4	Judge 5	Judge 6	Judge 7	Referee

Name _____

Signature _____

Lion Cup 2024 Luxembourg

297 Rue de Reckenthal L-2410 Strassen, LUXEMBOURG

Court Nr.	1	Pool	1	Date	2024-06-08	Field Position	61	
RED				BLUE				
NOC	ESSERS REINIER (NED)			NOC	PESCHIER KYANU (NED)			
Category	KUMITE MALE U14 -45kg_							
3 Points	2 Points	1 Point	Score	1 Point	2 Points	3 Points		
			1 : 5					
Penatlity				Penatlity				
C1: , C2:				1:5	C1: HC, C2:			
				Total	WINNER			

Decision of Superiority

Judge 1	Judge 2	Judge 3	Judge 4	Judge 5	Judge 6	Judge 7	Referee

Name _____

Signature _____

Lion Cup 2024 Luxembourg

297 Rue de Reckenthal L-2410 Strassen, LUXEMBOURG

Court Nr.	1	Pool	1	Date	2024-06-08	Field Position	62	
RED				BLUE				
NOC	YILDIRM ALI (LUX)			NOC	ENTHOVEN SCOTT (NED)			
Category	KUMITE MALE U14 -45kg_							
3 Points	2 Points	1 Point	Score	1 Point	2 Points	3 Points		
			3 : 1					
Penatlity				Penatlity				
C1: HC, C2:				3:1	C1: C1, C2:			
WINNER				Total				

Decision of Superiority

Judge 1	Judge 2	Judge 3	Judge 4	Judge 5	Judge 6	Judge 7	Referee

Name _____

Signature _____

Lion Cup 2024 Luxembourg

297 Rue de Reckenthal L-2410 Strassen, LUXEMBOURG

Court Nr.	1	Pool	1	Date	2024-06-08	Field Position	63
RED				BLUE			
NOC	PESCHIER KYANU (NED)			NOC	YILDIRM ALI (LUX)		
Category	KUMITE MALE U14 -45kg_						
3 Points	2 Points	1 Point	Score	1 Point	2 Points	3 Points	
			3 : 1				
Penatlity				Penatlity			
C1: HC, C2:				3:1	C1: , C2:		
WINNER				Total			

Decision of Superiority

Judge 1	Judge 2	Judge 3	Judge 4	Judge 5	Judge 6	Judge 7	Referee

Name _____

Signature _____

Lion Cup 2024 Luxembourg

297 Rue de Reckenthal L-2410 Strassen, LUXEMBOURG

Court Nr.	1	Pool	1	Date	2024-06-08	Field Position	0
RED				BLUE			
NOC	ES-SALEHY ISMAIL (BEL)			NOC	ESSERS REINIER (NED)		
Category	KUMITE MALE U14 -45kg_						
3 Points	2 Points	1 Point	Score	1 Point	2 Points	3 Points	
			4 : 5				
Penatlity				Penatlity			
C1: H, C2:			4:5	C1: HC, C2:			
			Total	WINNER			

Decision of Superiority

Judge 1	Judge 2	Judge 3	Judge 4	Judge 5	Judge 6	Judge 7	Referee

Name _____

Signature _____

Lion Cup 2024 Luxembourg

297 Rue de Reckenthal L-2410 Strassen, LUXEMBOURG

Court Nr.	1	Pool	1	Date	2024-06-08	Field Position	2
RED				BLUE			
NOC	ES-SALEHY ISMAIL (BEL)			NOC	BATTISTEL FLORIN (SUI)		
Category	KUMITE MALE U14 -45kg_						
3 Points	2 Points	1 Point	Score	1 Point	2 Points	3 Points	
			:				
Penatlity				Penatlity			
			Total				

Decision of Superiority

Judge 1	Judge 2	Judge 3	Judge 4	Judge 5	Judge 6	Judge 7	Referee

Name _____

Signature _____

Lion Cup 2024 Luxembourg

297 Rue de Reckenthal L-2410 Strassen, LUXEMBOURG

Court Nr.	2	Pool	2	Date	2024-06-08	Field Position	0
RED				BLUE			
NOC	WERNER RUBEN (NED)			NOC	ENTHOVEN SCOTT (NED)		
Category	KUMITE MALE U14 -45kg_						
3 Points	2 Points	1 Point	Score	1 Point	2 Points	3 Points	
			0 : 5				
Penatlity				Penatlity			
C1: C1, C2:				0:5	C1: , C2:		
				Total	WINNER		

Decision of Superiority

Judge 1	Judge 2	Judge 3	Judge 4	Judge 5	Judge 6	Judge 7	Referee

Name _____

Signature _____

Lion Cup 2024 Luxembourg

297 Rue de Reckenthal L-2410 Strassen, LUXEMBOURG

Court Nr.	2	Pool	2	Date	2024-06-08	Field Position	2	
RED				BLUE				
NOC	STIRBU DAVID (BEL)			NOC	WERNER RUBEN (NED)			
Category	KUMITE MALE U14 -45kg_							
3 Points	2 Points	1 Point	Score	1 Point	2 Points	3 Points		
			0 : 0					
Penatlity				Penatlity				
C1: , C2:				0:0	C1: , C2:			
				Total	WINNER			

KI

Decision of Superiority

Judge 1	Judge 2	Judge 3	Judge 4	Judge 5	Judge 6	Judge 7	Referee

Name _____

Signature _____

Lion Cup 2024 Luxembourg - 2024-06-07

Official Results

KUMITE MALE U14 -45kg_			
1	PESCHIER KYANU		NED - NETHERLANDS
2	YILDIRM ALI		LUX - LUXEMBOURG
3	ENTHOVEN SCOTT		NED - NETHERLANDS
3	ESSERS REINIER		NED - NETHERLANDS
5	WERNER RUBEN		NED - NETHERLANDS
5	ES-SALEHY ISMAIL		BEL - BELGIUM
7	STIRBU DAVID		BEL - BELGIUM
7	BATTISTEL FLORIN		SUI - SWITZERLAND

KUMITE FEMALE SENIOR +68KG

Lion Cup 2024 Luxembourg

ENTRIES BY WEIGHT CATEGORY
Kumite Female Senior +68kg

As of 8 JUN 2024

NOC Code	Gender	Name	Seeding
FIN	F	Voutilainen Sonja	
NED	F	Koetsier Sanne	
NED	F	Telles Jenna	
NED	F	van Wezel Robin	
NED	F	Zollner Kimberley	
POL	F	Nykolyn Yuliia	
SUI	F	Bonjour Pauline	
SUI	F	Bonny Shania	
SUI	F	Kaufmann Fabienne	
SUI	F	Rose Nolet Lily	

Kumite Female Senior +68kg

Lion Cup 2024 Luxembourg, 297 Rue de Reckenthal L-2410 Strassen, LUX

2024-06-08

Tatami
4 09:10

Pool
1 / 1

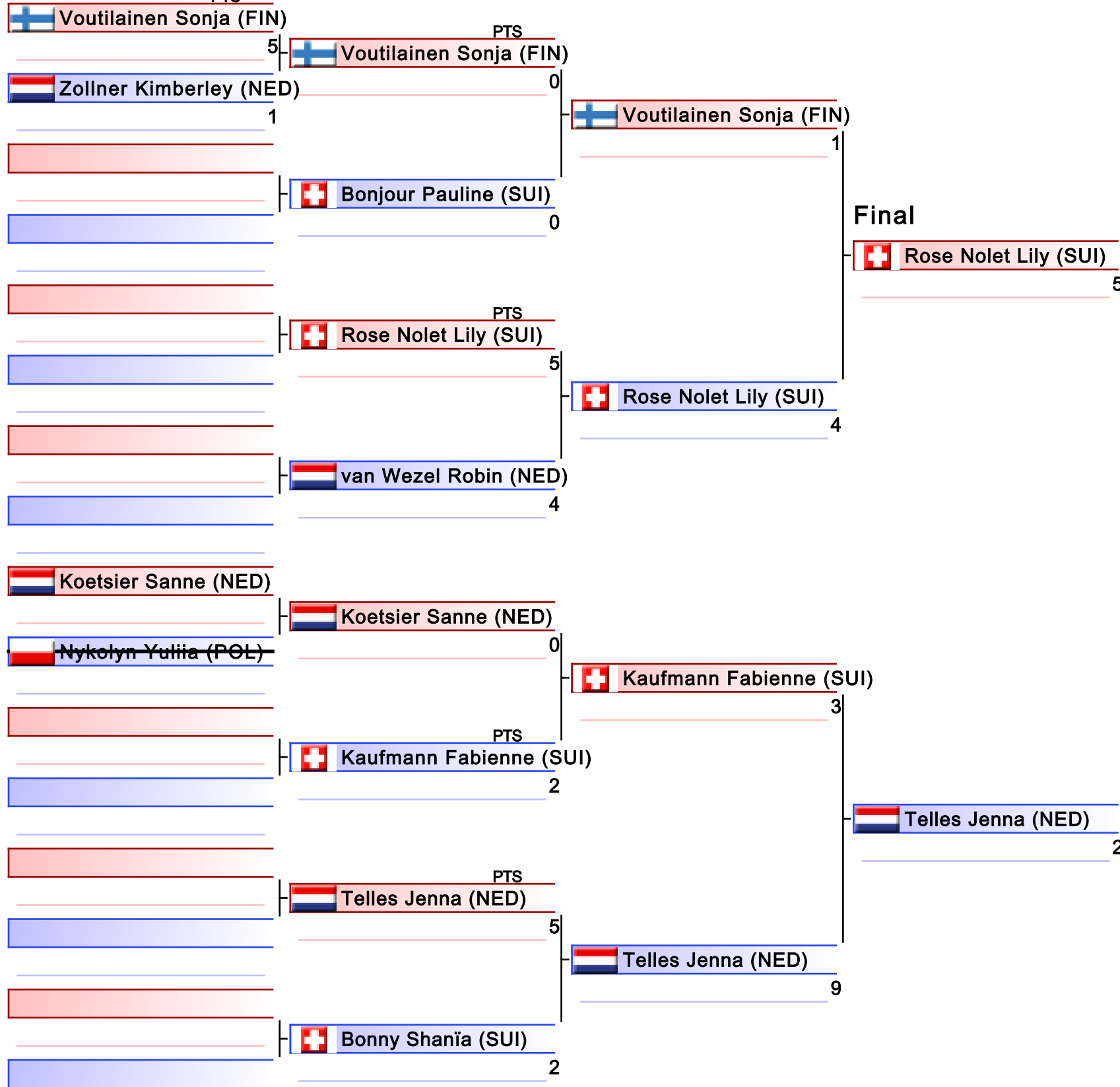

1. ROSE NOLET LILY (SUI)
2. TELLES JENNA (NED)
3. VAN WEZEL ROBIN (NED)
3. KAUFMANN FABIENNE (SUI)
5. VOUTILAINEN SONJA (FIN)
5. BONNY SHANĬA (SUI)

Kumite Female Senior +68kg

Lion Cup 2024 Luxembourg

2024-06-08

Tatami
4 09:40

Pool
1

(c)sportdata GmbH & Co KG 2000-2024 (2024-06-08 18:41) v 10.1.0 build 1 (2024-01-24 23:23 CET) License: Online_Event_ID-7672_LionCup2024Luxembourg (expire 2024-06-21)

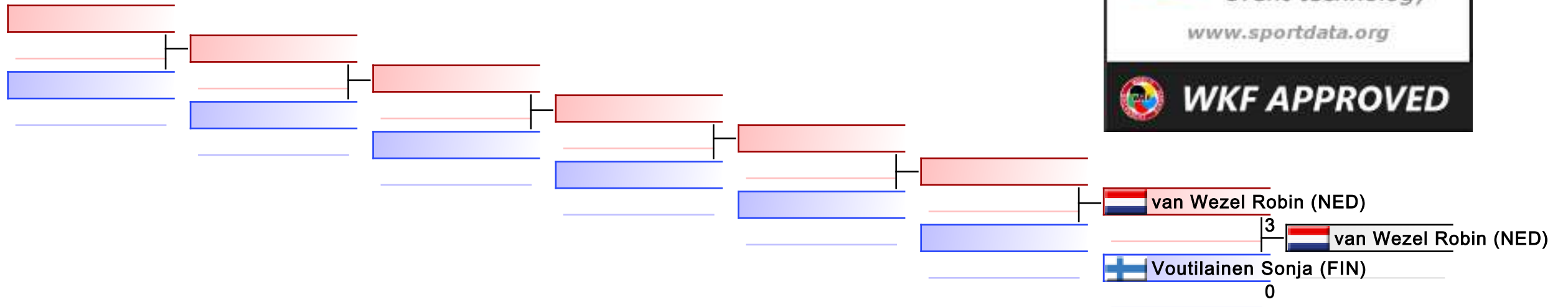

REPECHAGE: (1)

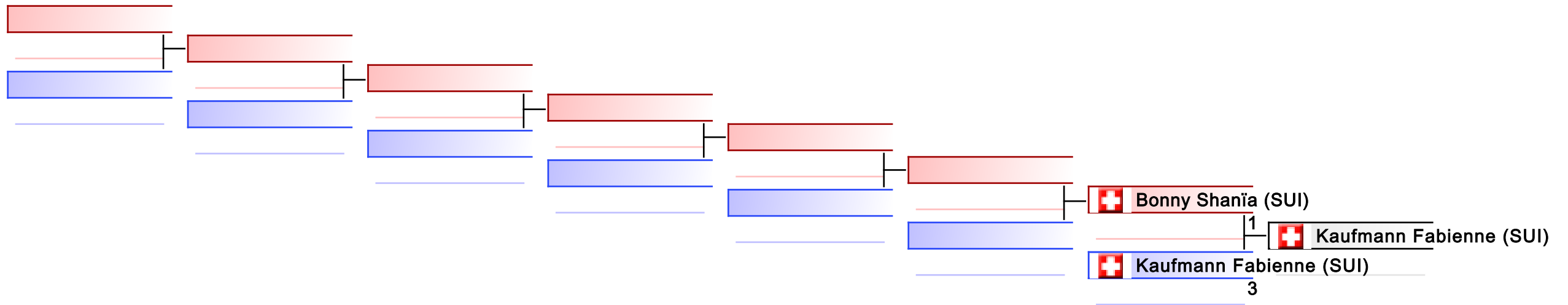

Lion Cup 2024 Luxembourg

297 Rue de Reckenthal L-2410 Strassen, LUXEMBOURG

Court Nr.	1	Pool	1	Date	2024-06-08	Field Position	49
RED				BLUE			
NOC	VOUTILAINEN SONJA (FIN)			NOC	ZOLLNER KIMBERLEY (NED)		
Category	Kumite Female Senior +68kg						
3 Points	2 Points	1 Point	Score	1 Point	2 Points	3 Points	
			5 : 1				
Penatlity					Penatlity		
C1: C2, C2:				5:1	C1: , C2:		
WINNER				Total			

PTS

Decision of Superiority

Judge 1	Judge 2	Judge 3	Judge 4	Judge 5	Judge 6	Judge 7	Referee

Name _____

Signature _____

Lion Cup 2024 Luxembourg

297 Rue de Reckenthal L-2410 Strassen, LUXEMBOURG

Court Nr.	1	Pool	1	Date	2024-06-08	Field Position	57	
RED				BLUE				
NOC	VOUTILAINEN SONJA (FIN)			NOC	BONJOUR PAULINE (SUI)			
Category	Kumite Female Senior +68kg							
3 Points	2 Points	1 Point	Score	1 Point	2 Points	3 Points		
			0 : 0					
Penatlity				Penatlity				
C1: C3, C2:				0:0	C1: HC, C2:			
WINNER				Total				

PTS

Decision of Superiority

Judge 1	Judge 2	Judge 3	Judge 4	Judge 5	Judge 6	Judge 7	Referee

Name _____

Signature _____

Lion Cup 2024 Luxembourg

297 Rue de Reckenthal L-2410 Strassen, LUXEMBOURG

Court Nr.	1	Pool	1	Date	2024-06-08	Field Position	58	
RED				BLUE				
NOC	ROSE NOLET LILY (SUI)			NOC	VAN WEZEL ROBIN (NED)			
Category	Kumite Female Senior +68kg							
3 Points	2 Points	1 Point	Score	1 Point	2 Points	3 Points		
			5 : 4					
Penatlity				Penatlity				
C1: HC, C2:				5:4	C1: HC, C2:			
WINNER				Total				

PTS

Decision of Superiority

Judge 1	Judge 2	Judge 3	Judge 4	Judge 5	Judge 6	Judge 7	Referee

Name _____

Signature _____

Lion Cup 2024 Luxembourg

297 Rue de Reckenthal L-2410 Strassen, LUXEMBOURG

Court Nr.	1	Pool	1	Date	2024-06-08	Field Position	59	
RED				BLUE				
NOC	KOETSIER SANNE (NED)			NOC	KAUFMANN FABIENNE (SUI)			
Category	Kumite Female Senior +68kg							
3 Points	2 Points	1 Point	Score	1 Point	2 Points	3 Points		
			0 : 2					
Penatlity				Penatlity				
C1: C1, C2:				0:2	C1: C2, C2:			
				Total	WINNER			

PTS

Decision of Superiority

Judge 1	Judge 2	Judge 3	Judge 4	Judge 5	Judge 6	Judge 7	Referee

Name _____

Signature _____

Lion Cup 2024 Luxembourg

297 Rue de Reckenthal L-2410 Strassen, LUXEMBOURG

Court Nr.	1	Pool	1	Date	2024-06-08	Field Position	60
RED				BLUE			
NOC	TELLES JENNA (NED)			NOC	BONNY SHANA (SUI)		
Category	Kumite Female Senior +68kg						
3 Points	2 Points	1 Point	Score	1 Point	2 Points	3 Points	
			5 : 2				
Penatlity				Penatlity			
C1: C1, C2:			5:2	C1: C1, C2:			
WINNER			Total				

PTS

Decision of Superiority

Judge 1	Judge 2	Judge 3	Judge 4	Judge 5	Judge 6	Judge 7	Referee

Name _____

Signature _____

Lion Cup 2024 Luxembourg

297 Rue de Reckenthal L-2410 Strassen, LUXEMBOURG

Court Nr.	1	Pool	1	Date	2024-06-08	Field Position	61	
RED				BLUE				
NOC	VOUTILAINEN SONJA (FIN)			NOC	ROSE NOLET LILY (SUI)			
Category	Kumite Female Senior +68kg							
3 Points	2 Points	1 Point	Score	1 Point	2 Points	3 Points		
			1 : 4					
Penatlity				Penatlity				
C1: C1, C2:				1:4	C1: HC, C2:			
				Total	WINNER			

Decision of Superiority

Judge 1	Judge 2	Judge 3	Judge 4	Judge 5	Judge 6	Judge 7	Referee

Name _____

Signature _____

Lion Cup 2024 Luxembourg

297 Rue de Reckenthal L-2410 Strassen, LUXEMBOURG

Court Nr.	1	Pool	1	Date	2024-06-08	Field Position	62	
RED				BLUE				
NOC	KAUFMANN FABIENNE (SUI)			NOC	TELLES JENNA (NED)			
Category	Kumite Female Senior +68kg							
3 Points	2 Points	1 Point	Score	1 Point	2 Points	3 Points		
			3 : 9					
Penatlity				Penatlity				
C1: , C2:				3:9	C1: HC, C2:			
				Total	WINNER			

Decision of Superiority

Judge 1	Judge 2	Judge 3	Judge 4	Judge 5	Judge 6	Judge 7	Referee

Name _____

Signature _____

Lion Cup 2024 Luxembourg

297 Rue de Reckenthal L-2410 Strassen, LUXEMBOURG

Court Nr.	1	Pool	1	Date	2024-06-08	Field Position	63
RED				BLUE			
NOC	ROSE NOLET LILY (SUI)			NOC	TELLES JENNA (NED)		
Category	Kumite Female Senior +68kg						
3 Points	2 Points	1 Point	Score	1 Point	2 Points	3 Points	
			5 : 2				
Penatlity				Penatlity			
C1: C3, C2:			5:2	C1: , C2:			
WINNER			Total				

Decision of Superiority

Judge 1	Judge 2	Judge 3	Judge 4	Judge 5	Judge 6	Judge 7	Referee

Name _____

Signature _____

Lion Cup 2024 Luxembourg

297 Rue de Reckenthal L-2410 Strassen, LUXEMBOURG

Court Nr.	1	Pool	1	Date	2024-06-08	Field Position	0
RED				BLUE			
NOC	VAN WEZEL ROBIN (NED)			NOC	VOUTILAINEN SONJA (FIN)		
Category	Kumite Female Senior +68kg						
3 Points	2 Points	1 Point	Score	1 Point	2 Points	3 Points	
			:				
Penatlity				Penatlity			
			Total				

Decision of Superiority

Judge 1	Judge 2	Judge 3	Judge 4	Judge 5	Judge 6	Judge 7	Referee

Name _____

Signature _____

Lion Cup 2024 Luxembourg

297 Rue de Reckenthal L-2410 Strassen, LUXEMBOURG

Court Nr.	2	Pool	2	Date	2024-06-08	Field Position	0
RED				BLUE			
NOC	BONNY SHANA (SUI)			NOC	KAUFMANN FABIENNE (SUI)		
Category	Kumite Female Senior +68kg						
3 Points	2 Points	1 Point	Score	1 Point	2 Points	3 Points	
			1 : 3				
Penatlity				Penatlity			
C1: C2, C2:			1:3	C1: C1, C2:			
			Total	WINNER			







Decision of Superiority

Judge 1	Judge 2	Judge 3	Judge 4	Judge 5	Judge 6	Judge 7	Referee

Name _____

Signature _____

Official Results

Kumite Female Senior +68kg			
1	ROSE NOLET LILY		SUI - SWITZERLAND
2	TELLES JENNA		NED - NETHERLANDS
3	VAN WEZEL ROBIN		NED - NETHERLANDS
3	KAUFMANN FABIENNE		SUI - SWITZERLAND
5	VOUTILAINEN SONJA		FIN - FINLAND
5	BONNY SHANIA		SUI - SWITZERLAND

KUMITE FEMALE SENIOR -50KG

Lion Cup 2024 Luxembourg

ENTRIES BY WEIGHT CATEGORY
Kumite Female Senior -50kg

As of 8 JUN 2024

NOC Code	Gender	Name	Seeding
BEL	F	Guinotte Shona	
FRA	F	Bas Loussine	
LUX	F	Belabass Kenza	
LUX	F	Bezruk Olha	
NED	F	Yalçin Samina	
SUI	F	Boutracit Aïcha	
SUI	F	Huber Lea	

Kumite Female Senior -50kg

Lion Cup 2024 Luxembourg, 297 Rue de Reckenthal L-2410 Strassen, LUX

2024-06-08

Tatami
6 09:40

Pool
1 / 1

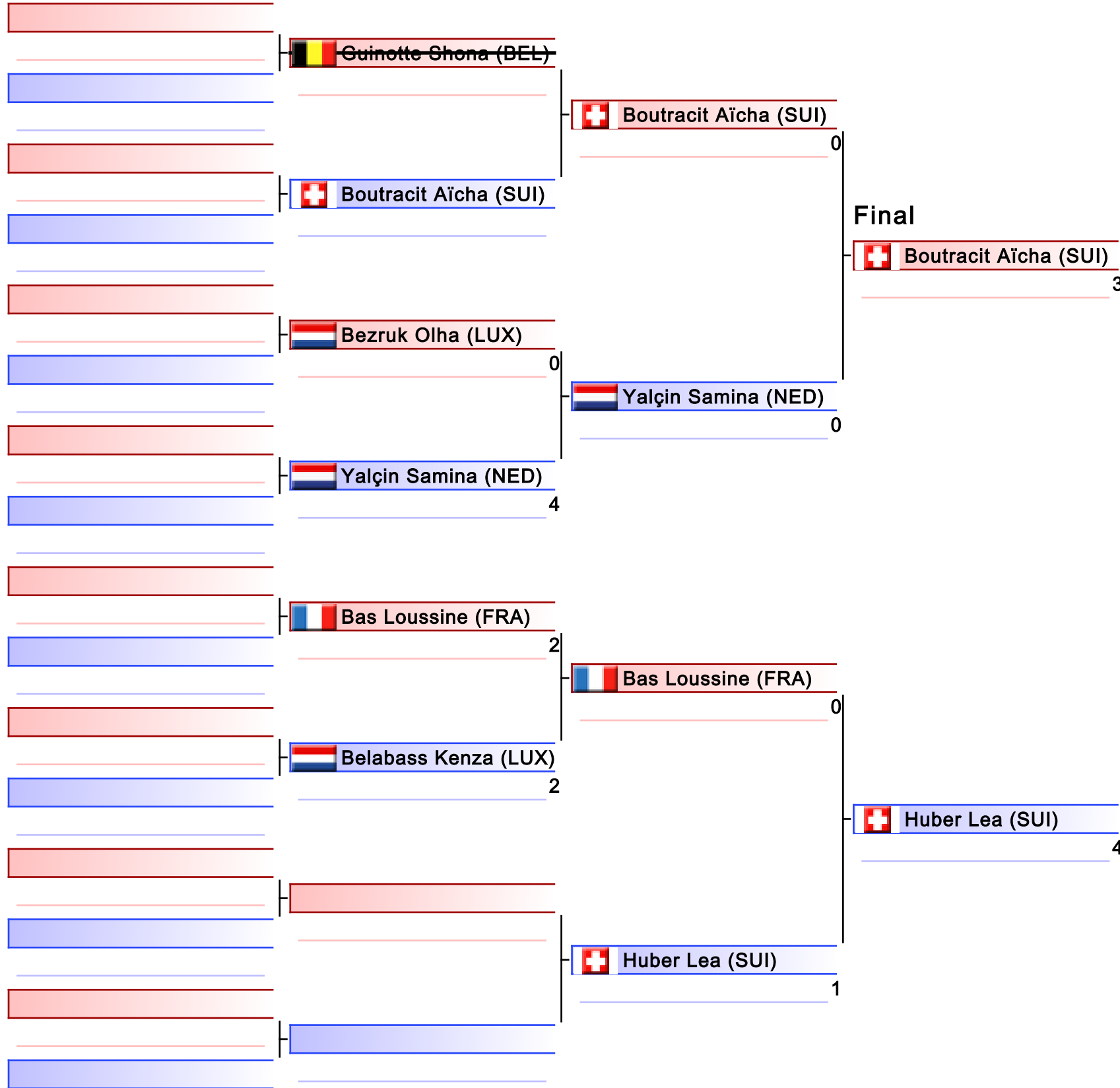

1. HUBER LEA (SUI)
2. BOUTRACIT AÏCHA (SUI)
3. YALÇIN SAMINA (NED)
3. BAS LOUSSINE (FRA)

Kumite Female Senior -50kg

Lion Cup 2024 Luxembourg

2024-06-08

Tatami
6 10:05

Pool
1

(c)sportdata GmbH & Co KG 2000-2024 (2024-06-08 18:41) v 10.1.0 build 1 (2024-01-24 23:23 CET) License: Online_Event_ID-7672_LionCup2024Luxembourg (expire 2024-06-21)

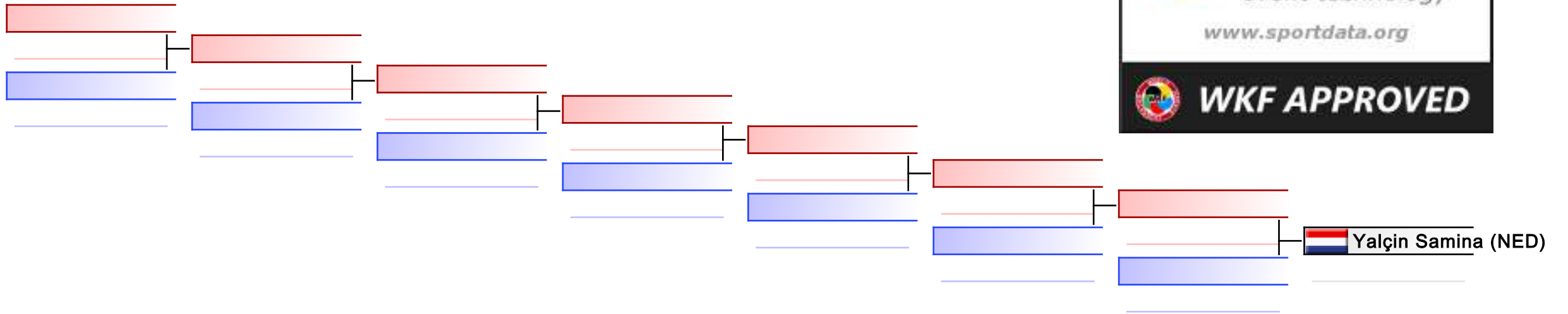

REPECHAGE: (1)

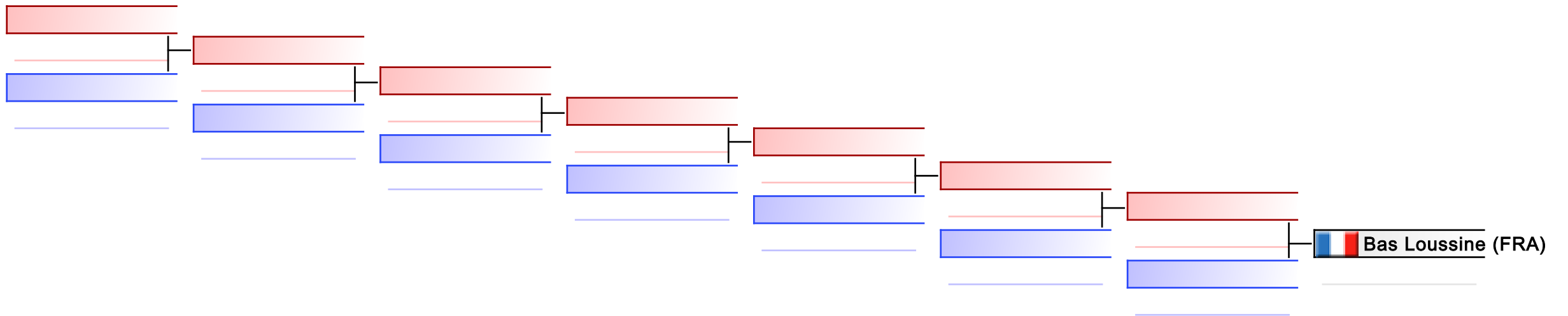

Lion Cup 2024 Luxembourg

297 Rue de Reckenthal L-2410 Strassen, LUXEMBOURG

Court Nr.	1	Pool	1	Date	2024-06-08	Field Position	58
RED				BLUE			
NOC	BEZRUK OLHA (LUX)			NOC	YALIN SAMINA (NED)		
Category	Kumite Female Senior -50kg						
3 Points	2 Points	1 Point	Score	1 Point	2 Points	3 Points	
			0 : 4				
Penatlity				Penatlity			
C1: , C2:			0:4	C1: HC, C2:			
			Total	WINNER			

Decision of Superiority

Judge 1	Judge 2	Judge 3	Judge 4	Judge 5	Judge 6	Judge 7	Referee

Name _____

Signature _____

Lion Cup 2024 Luxembourg

297 Rue de Reckenthal L-2410 Strassen, LUXEMBOURG

Court Nr.	1	Pool	1	Date	2024-06-08	Field Position	59
RED				BLUE			
NOC	BAS LOUSSINE (FRA)			NOC	BELABASS KENZA (LUX)		
Category	Kumite Female Senior -50kg						
3 Points	2 Points	1 Point	Score	1 Point	2 Points	3 Points	
			2 : 2				
Penatlity				Penatlity			
C1: C1, C2:			2:2	C1: C2, C2:			
WINNER			Total				

Decision of Superiority

Judge 1	Judge 2	Judge 3	Judge 4	Judge 5	Judge 6	Judge 7	Referee

Name _____

Signature _____

Lion Cup 2024 Luxembourg

297 Rue de Reckenthal L-2410 Strassen, LUXEMBOURG

Court Nr.	1	Pool	1	Date	2024-06-08	Field Position	61
RED				BLUE			
NOC	BOUTRACIT ACHA (SUI)			NOC	YALIN SAMINA (NED)		
Category	Kumite Female Senior -50kg						
3 Points	2 Points	1 Point	Score	1 Point	2 Points	3 Points	
			0 : 0				
Penatlity				Penatlity			
C1: C1, C2:			0:0	C1: C1, C2:			
WINNER			Total				

Decision of Superiority

Judge 1	Judge 2	Judge 3	Judge 4	Judge 5	Judge 6	Judge 7	Referee

Name _____

Signature _____

Lion Cup 2024 Luxembourg

297 Rue de Reckenthal L-2410 Strassen, LUXEMBOURG

Court Nr.	1	Pool	1	Date	2024-06-08	Field Position	62
RED				BLUE			
NOC	BAS LOUSSINE (FRA)			NOC	HUBER LEA (SUI)		
Category	Kumite Female Senior -50kg						
3 Points	2 Points	1 Point	Score	1 Point	2 Points	3 Points	
			0 : 1				
Penatlity					Penatlity		
C1: C1, C2:				0:1	C1: HC, C2:		
				Total	WINNER		

Decision of Superiority

Judge 1	Judge 2	Judge 3	Judge 4	Judge 5	Judge 6	Judge 7	Referee

Name _____

Signature _____

Lion Cup 2024 Luxembourg

297 Rue de Reckenthal L-2410 Strassen, LUXEMBOURG

Court Nr.	1	Pool	1	Date	2024-06-08	Field Position	63	
RED				BLUE				
NOC	BOUTRACIT ACHA (SUI)			NOC	HUBER LEA (SUI)			
Category	Kumite Female Senior -50kg							
3 Points	2 Points	1 Point	Score	1 Point	2 Points	3 Points		
			3 : 4					
Penatlity				Penatlity				
C1: C3, C2:				3:4	C1: HC, C2:			
				Total	WINNER			

Decision of Superiority





Judge 1	Judge 2	Judge 3	Judge 4	Judge 5	Judge 6	Judge 7	Referee

Name _____

Signature _____

Lion Cup 2024 Luxembourg - 2024-06-07

Official Results

Kumite Female Senior -50kg			
1	HUBER LEA		SUI - SWITZERLAND
2	BOUTRACIT AÏCHA		SUI - SWITZERLAND
3	YALÇIN SAMINA		NED - NETHERLANDS
3	BAS LOUSSINE		FRA - FRANCE

KUMITE FEMALE SENIOR -55 KG

Lion Cup 2024 Luxembourg

ENTRIES BY WEIGHT CATEGORY
Kumite Female Senior -55 kg

As of 8 JUN 2024

NOC Code	Gender	Name	Seeding
BEL	F	Ejja Imane	
ENG	F	Monk Rosie	
LUX	F	Da Nazare Lena	
LUX	F	Nobre Ameixa Cynthia	
LUX	F	Warling Jenny	
NED	F	Göktekin Simla	
NED	F	van den Brand Julie	
NOR	F	Rasmussen Maja Knøvl	

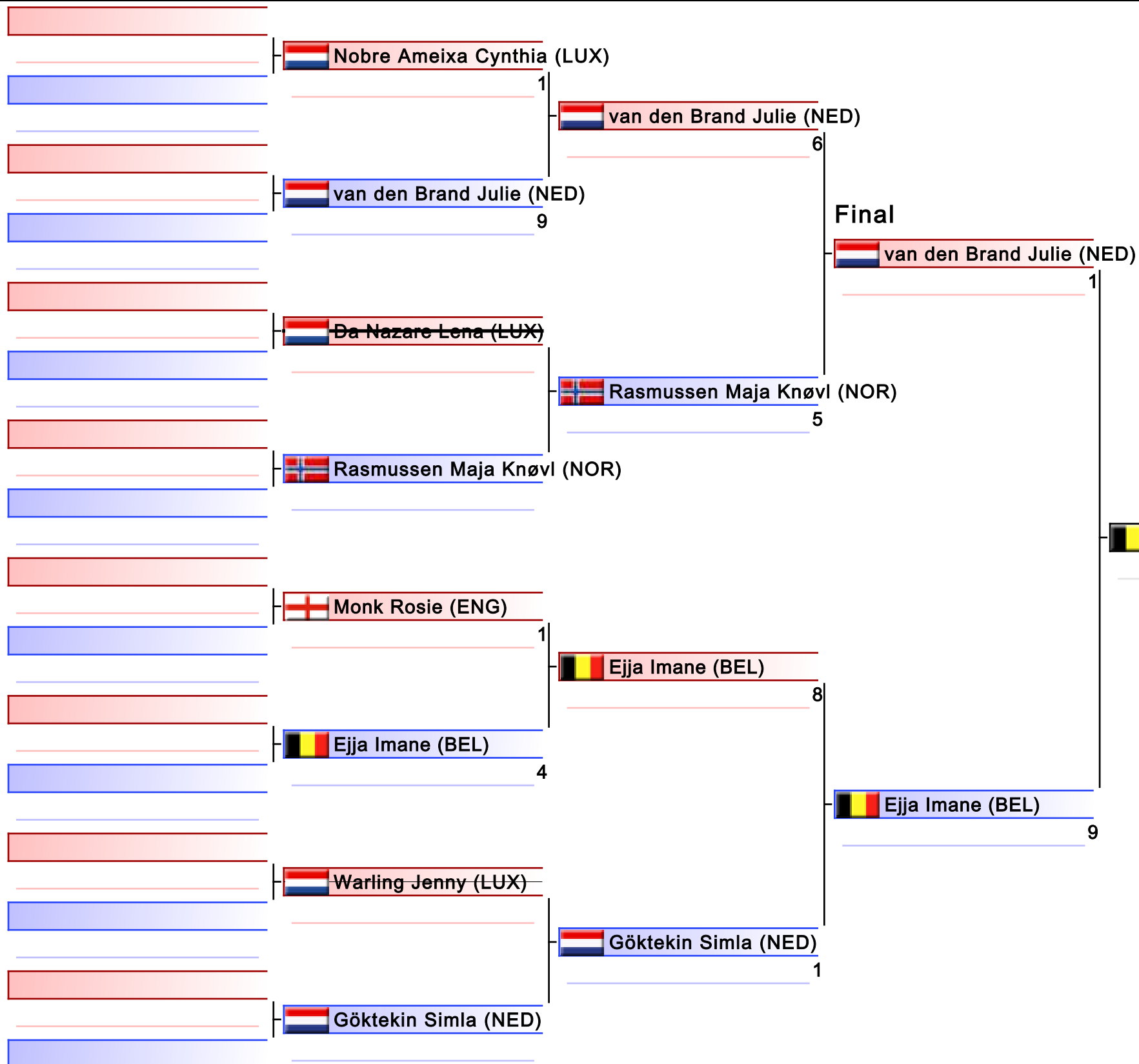

1. EJJA IMANE (BEL)
2. VAN DEN BRAND JULIE (NED)
3. RASMUSSEN MAJA KNØVL (NOR)
3. GÖKTEKIN SIMLA (NED)
5. NOBRE AMEIXA CYNTHIA (LUX)
5. MONK ROSIE (ENG)

Kumite Female Senior -55 kg

Lion Cup 2024 Luxembourg

2024-06-08

Tatami
3 10:50

Pool
1

(c)sportdata GmbH & Co KG 2000-2024 (2024-06-08 18:41) v 10.1.0 build 1 (2024-01-24 23:23 CET) License: Online_Event_ID-7672_LionCup2024Luxembourg (expire 2024-06-21)

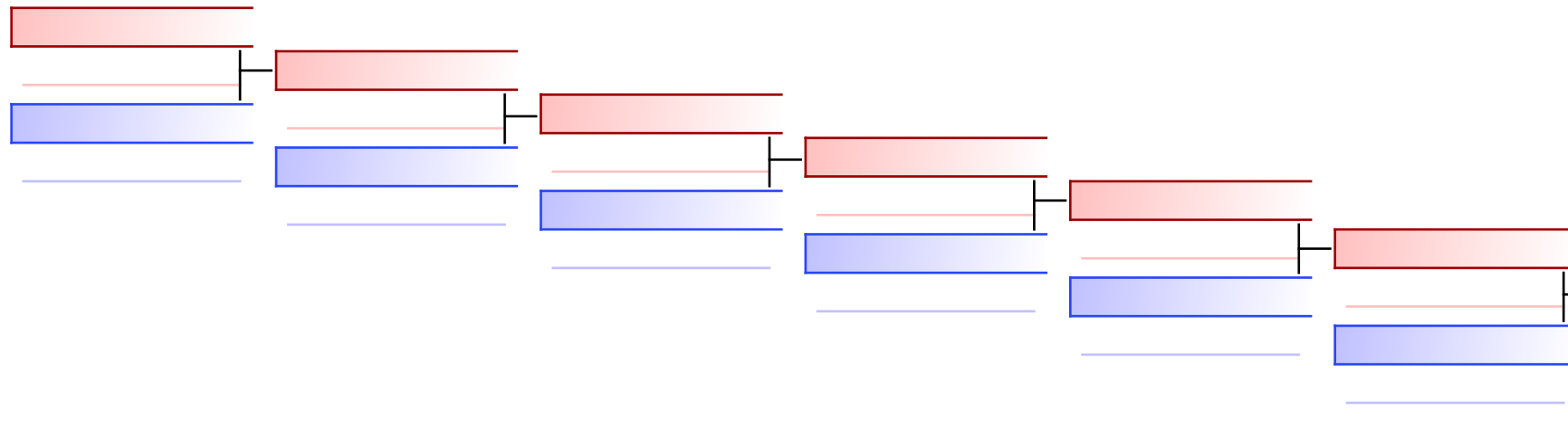

Nobre Ameixa Cynthia (LUX)
1
 Rasmussen Maja Knøvl (NOR)
 Rasmussen Maja Knøvl (NOR)
5

REPECHAGE: (1)

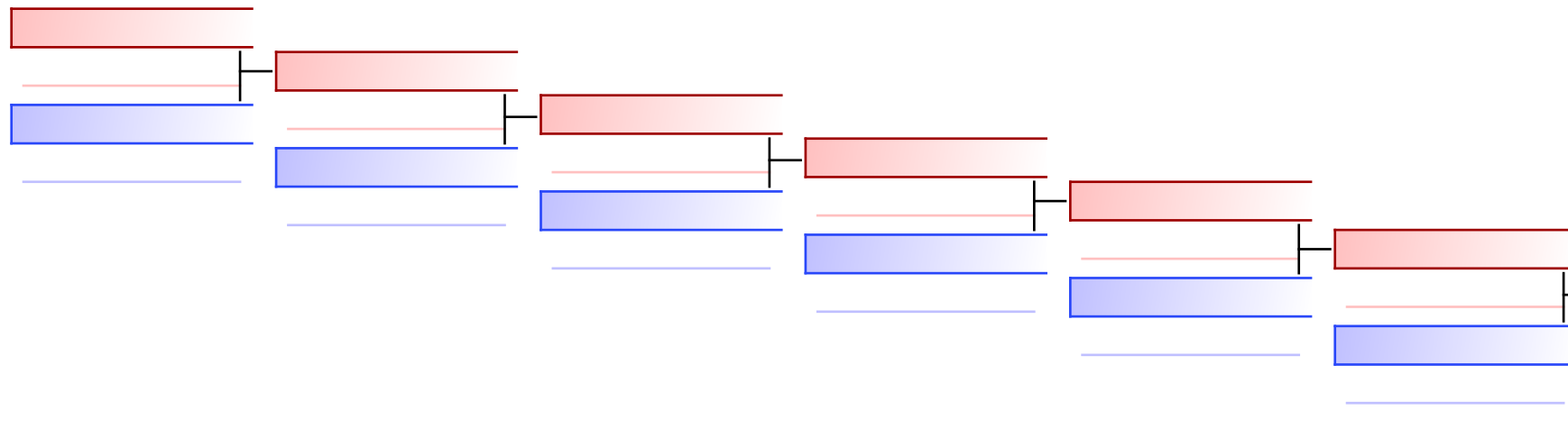

Monk Rosie (ENG)
3
 Göktekin Simla (NED)
 Göktekin Simla (NED)
7

Lion Cup 2024 Luxembourg

297 Rue de Reckenthal L-2410 Strassen, LUXEMBOURG

Court Nr.	1	Pool	1	Date	2024-06-08	Field Position	57
RED				BLUE			
NOC	NOBRE AMEIXA CYNTHIA (LUX)			NOC	VAN DEN BRAND JULIE (NED)		
Category	Kumite Female Senior -55 kg						
3 Points	2 Points	1 Point	Score	1 Point	2 Points	3 Points	
			1 : 9				
Penatlity				Penatlity			
C1: , C2:				1:9	C1: C2, C2:		
				Total	WINNER		

Decision of Superiority

Judge 1	Judge 2	Judge 3	Judge 4	Judge 5	Judge 6	Judge 7	Referee

Name _____

Signature _____

Lion Cup 2024 Luxembourg

297 Rue de Reckenthal L-2410 Strassen, LUXEMBOURG

Court Nr.	1	Pool	1	Date	2024-06-08	Field Position	59
RED				BLUE			
NOC	MONK ROSIE (ENG)			NOC	EJJA IMANE (BEL)		
Category	Kumite Female Senior -55 kg						
3 Points	2 Points	1 Point	Score	1 Point	2 Points	3 Points	
			1 : 4				
Penatlity				Penatlity			
C1: , C2:			1:4	C1: C2, C2:			
			Total	WINNER			

Decision of Superiority

Judge 1	Judge 2	Judge 3	Judge 4	Judge 5	Judge 6	Judge 7	Referee

Name _____

Signature _____

Lion Cup 2024 Luxembourg

297 Rue de Reckenthal L-2410 Strassen, LUXEMBOURG

Court Nr.	1	Pool	1	Date	2024-06-08	Field Position	61	
RED				BLUE				
NOC	VAN DEN BRAND JULIE (NED)			NOC	RASMUSSEN MAJA KNVL (NOR)			
Category	Kumite Female Senior -55 kg							
3 Points	2 Points	1 Point	Score	1 Point	2 Points	3 Points		
			6 : 5					
Penatlity				Penatlity				
C1: C3, C2:				6:5	C1: C1, C2:			
WINNER				Total				

Decision of Superiority

Judge 1	Judge 2	Judge 3	Judge 4	Judge 5	Judge 6	Judge 7	Referee

Name _____

Signature _____

Lion Cup 2024 Luxembourg

297 Rue de Reckenthal L-2410 Strassen, LUXEMBOURG

Court Nr.	1	Pool	1	Date	2024-06-08	Field Position	62	
RED				BLUE				
NOC	EJJA IMANE (BEL)			NOC	GKTEKIN SIMLA (NED)			
Category	Kumite Female Senior -55 kg							
3 Points	2 Points	1 Point	Score	1 Point	2 Points	3 Points		
			8 : 1					
Penatlity				Penatlity				
C1: C1, C2:				8:1	C1: , C2:			
WINNER				Total				

Decision of Superiority

Judge 1	Judge 2	Judge 3	Judge 4	Judge 5	Judge 6	Judge 7	Referee

Name _____

Signature _____

Lion Cup 2024 Luxembourg

297 Rue de Reckenthal L-2410 Strassen, LUXEMBOURG

Court Nr.	1	Pool	1	Date	2024-06-08	Field Position	63
RED				BLUE			
NOC	VAN DEN BRAND JULIE (NED)			NOC	EJJA IMANE (BEL)		
Category	Kumite Female Senior -55 kg						
3 Points	2 Points	1 Point	Score	1 Point	2 Points	3 Points	
			1 : 9				
Penatlity				Penatlity			
C1: , C2:			1:9	C1: , C2:			
			Total	WINNER			

Decision of Superiority

Judge 1	Judge 2	Judge 3	Judge 4	Judge 5	Judge 6	Judge 7	Referee

Name _____

Signature _____

Lion Cup 2024 Luxembourg

297 Rue de Reckenthal L-2410 Strassen, LUXEMBOURG

Court Nr.	1	Pool	1	Date	2024-06-08	Field Position	0
RED				BLUE			
NOC	NOBRE AMEIXA CYNTHIA (LUX)			NOC	RASMUSSEN MAJA KNVL (NOR)		
Category	Kumite Female Senior -55 kg						
3 Points	2 Points	1 Point	Score	1 Point	2 Points	3 Points	
			:				
Penatlity				Penatlity			
			Total				

Decision of Superiority

Judge 1	Judge 2	Judge 3	Judge 4	Judge 5	Judge 6	Judge 7	Referee

Name _____

Signature _____

Lion Cup 2024 Luxembourg

297 Rue de Reckenthal L-2410 Strassen, LUXEMBOURG

Court Nr.	2	Pool	2	Date	2024-06-08	Field Position	0
RED				BLUE			
NOC	MONK ROSIE (ENG)			NOC	GKTEKIN SIMLA (NED)		
Category	Kumite Female Senior -55 kg						
3 Points	2 Points	1 Point	Score	1 Point	2 Points	3 Points	
			3 : 7				
Penatlity				Penatlity			
C1: , C2:			3:7	C1: C2, C2:			
			Total	WINNER			

Decision of Superiority

Judge 1	Judge 2	Judge 3	Judge 4	Judge 5	Judge 6	Judge 7	Referee

Name _____

Signature _____

Lion Cup 2024 Luxembourg - 2024-06-07

Official Results

Kumite Female Senior -55 kg			
1	EJJA IMANE		BEL - BELGIUM
2	VAN DEN BRAND JULIE		NED - NETHERLANDS
3	RASMUSSEN MAJA KNØVL		NOR - NORWAY
3	GÖKTEKIN SIMLA		NED - NETHERLANDS
5	NOBRE AMEIXA CYNTHIA		LUX - LUXEMBOURG
5	MONK ROSIE		ENG - ENGLAND

KUMITE FEMALE SENIOR -61KG

Lion Cup 2024 Luxembourg

ENTRIES BY WEIGHT CATEGORY
Kumite Female Senior -61kg

As of 8 JUN 2024

NOC Code	Gender	Name	Seeding
BEL	F	Choly Fostine	
BEL	F	LE MESTRE LARA	
FRA	F	bougrine amel	
LUX	F	TIZOURINE Lisa	
NED	F	Horsmans Joanna	
NED	F	Kaewborisut Lyana	
NED	F	Kakiay Ashley	
NED	F	Landman Merel	
POR	F	Carvalho Lara	
SUI	F	Bosshard Lea Marie	
SUI	F	Burri Liliane	
SUI	F	Quirici Melika	
SUI	F	Radjenovic Nina	
SUI	F	Rose Nolet Lily	
SUI	F	Wohlgemuth Naiya Elin	

Kumite Female Senior -61kg

Lion Cup 2024 Luxembourg, 297 Rue de Reckenthal L-2410 Strassen, LUX

2024-06-08

Tatami
6 10:20

Pool
1 / 1

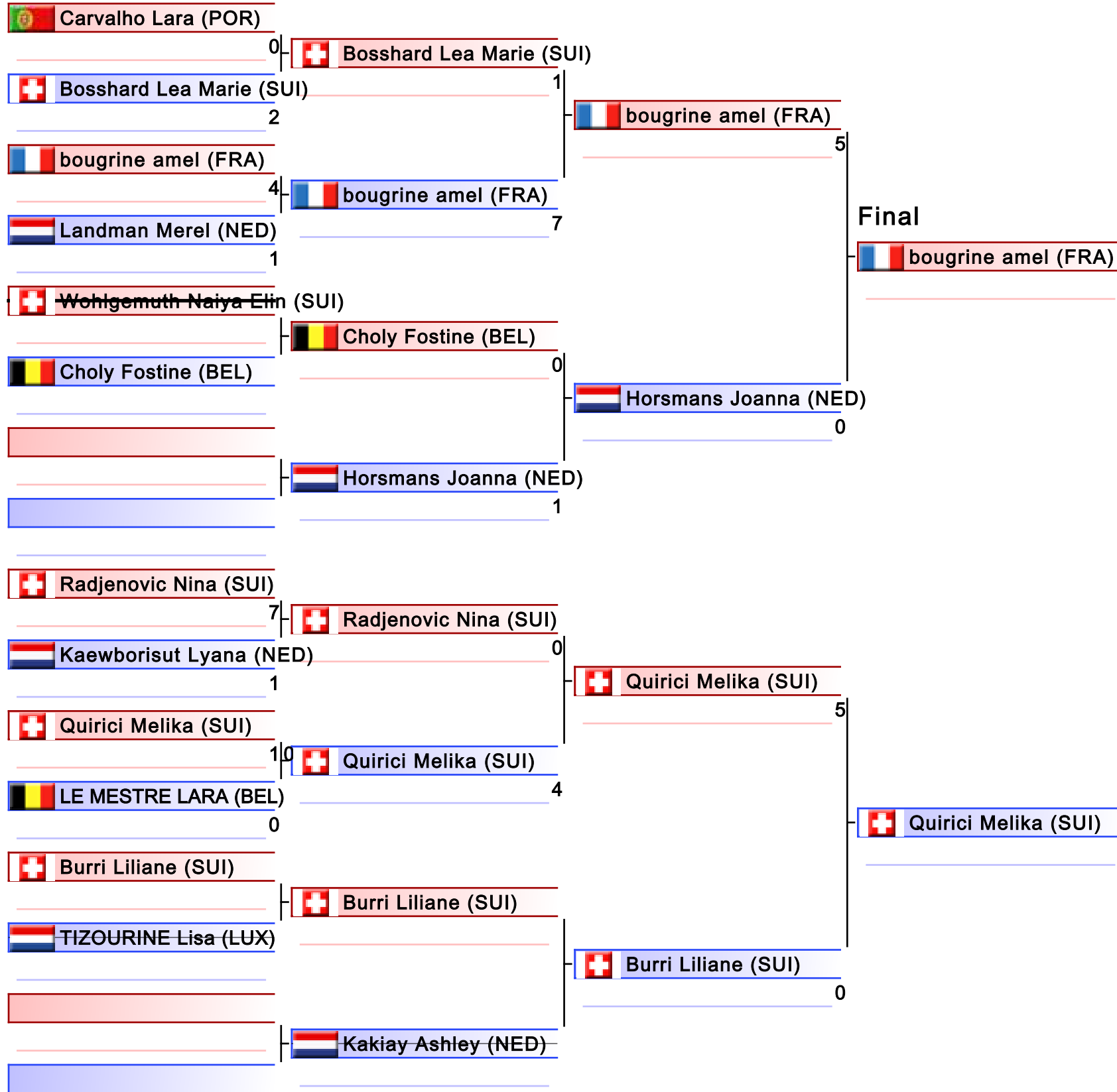

1. BOUGRINE AMEL (FRA)
2. QUIRICI MELIKA (SUI)
3. BOSSHARD LEA MARIE (SUI)
3. RADJENOVIC NINA (SUI)
5. HORSMANS JOANNA (NED)
5. BURRI LILIANE (SUI)
7. LANDMAN MEREL (NED)
7. LE MESTRE LARA (BEL)

Kumite Female Senior -61kg

Lion Cup 2024 Luxembourg

2024-06-08

Tatami
6 11:05

Pool
1

(c)sportdata GmbH & Co KG 2000-2024 (2024-06-08 18:41) v 10.1.0 build 1 (2024-01-24 23:23 CET) License: Online_Event_ID-7672_LionCup2024Luxembourg (expire 2024-06-21)

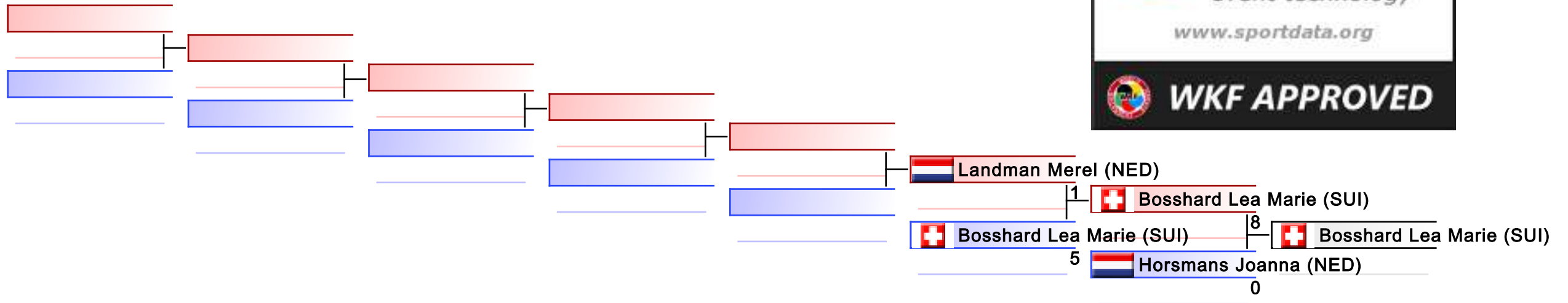

REPECHAGE: (1)

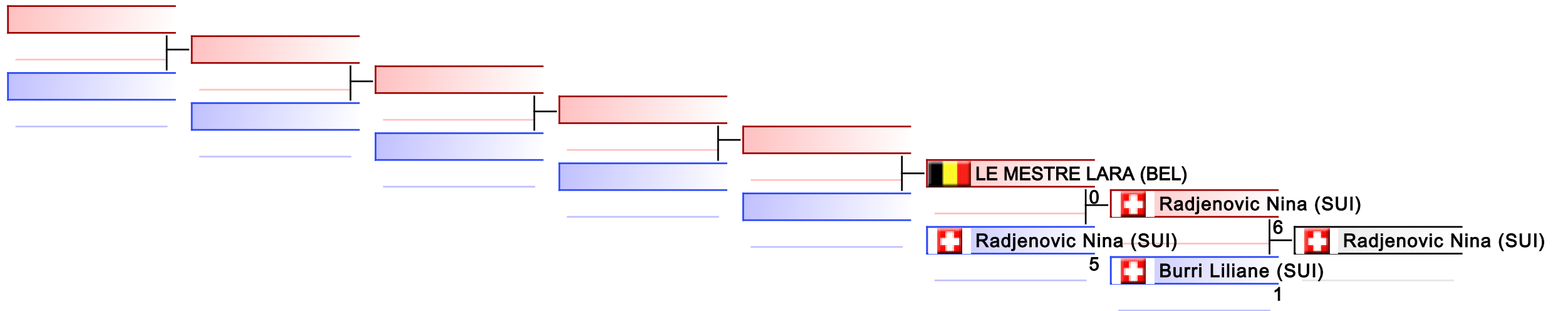

Lion Cup 2024 Luxembourg

297 Rue de Reckenthal L-2410 Strassen, LUXEMBOURG

Court Nr.	1	Pool	1	Date	2024-06-08	Field Position	49	
RED				BLUE				
NOC	CARVALHO LARA (POR)			NOC	BOSSHARD LEA MARIE (SUI)			
Category	Kumite Female Senior -61kg							
3 Points	2 Points	1 Point	Score	1 Point	2 Points	3 Points		
			0 : 2					
Penatlity				Penatlity				
C1: C2, C2:				0:2	C1: C2, C2:			
				Total	WINNER			

Decision of Superiority

Judge 1	Judge 2	Judge 3	Judge 4	Judge 5	Judge 6	Judge 7	Referee

Name _____

Signature _____

Lion Cup 2024 Luxembourg

297 Rue de Reckenthal L-2410 Strassen, LUXEMBOURG

Court Nr.	1	Pool	1	Date	2024-06-08	Field Position	50
RED				BLUE			
NOC	BOUGRINE AMEL (FRA)			NOC	LANDMAN MEREL (NED)		
Category	Kumite Female Senior -61kg						
3 Points	2 Points	1 Point	Score	1 Point	2 Points	3 Points	
			4 : 1				
Penatlity				Penatlity			
C1: HC, C2:			4:1	C1: C1, C2:			
WINNER			Total				

Decision of Superiority

Judge 1	Judge 2	Judge 3	Judge 4	Judge 5	Judge 6	Judge 7	Referee

Name _____

Signature _____

Lion Cup 2024 Luxembourg

297 Rue de Reckenthal L-2410 Strassen, LUXEMBOURG

Court Nr.	1	Pool	1	Date	2024-06-08	Field Position	53	
RED				BLUE				
NOC	RADJENOVIC NINA (SUI)			NOC	KAEWBORISUT LYANA (NED)			
Category	Kumite Female Senior -61kg							
3 Points	2 Points	1 Point	Score	1 Point	2 Points	3 Points		
			7 : 1					
Penatlity				Penatlity				
C1: C3, C2:				7:1	C1: HC, C2:			
WINNER				Total				

Decision of Superiority

Judge 1	Judge 2	Judge 3	Judge 4	Judge 5	Judge 6	Judge 7	Referee

Name _____

Signature _____

Lion Cup 2024 Luxembourg

297 Rue de Reckenthal L-2410 Strassen, LUXEMBOURG

Court Nr.	1	Pool	1	Date	2024-06-08	Field Position	54	
RED				BLUE				
NOC	QUIRICI MELIKA (SUI)			NOC	LE MESTRE LARA (BEL)			
Category	Kumite Female Senior -61kg							
3 Points	2 Points	1 Point	Score	1 Point	2 Points	3 Points		
			10 : 0					
Penatlity				Penatlity				
			C1: , C2:	10:0				C1: , C2:
			WINNER	Total				

Decision of Superiority

Judge 1	Judge 2	Judge 3	Judge 4	Judge 5	Judge 6	Judge 7	Referee

Name _____

Signature _____

Lion Cup 2024 Luxembourg

297 Rue de Reckenthal L-2410 Strassen, LUXEMBOURG

Court Nr.	1	Pool	1	Date	2024-06-08	Field Position	57	
RED				BLUE				
NOC	BOSSHARD LEA MARIE (SUI)			NOC	BOUGRINE AMEL (FRA)			
Category	Kumite Female Senior -61kg							
3 Points	2 Points	1 Point	Score	1 Point	2 Points	3 Points		
			1 : 7					
Penatlity				Penatlity				
C1: HC, C2:				1:7	C1: C2, C2:			
				Total	WINNER			

Decision of Superiority

Judge 1	Judge 2	Judge 3	Judge 4	Judge 5	Judge 6	Judge 7	Referee

Name _____

Signature _____

Lion Cup 2024 Luxembourg

297 Rue de Reckenthal L-2410 Strassen, LUXEMBOURG

Court Nr.	1	Pool	1	Date	2024-06-08	Field Position	58
RED				BLUE			
NOC	CHOLY FOSTINE (BEL)			NOC	HORSMANS JOANNA (NED)		
Category	Kumite Female Senior -61kg						
3 Points	2 Points	1 Point	Score	1 Point	2 Points	3 Points	
			0 : 1				
Penatlity				Penatlity			
C1: C2, C2:			0:1	C1: C1, C2:			
			Total	WINNER			

Decision of Superiority

Judge 1	Judge 2	Judge 3	Judge 4	Judge 5	Judge 6	Judge 7	Referee

Name _____

Signature _____

Lion Cup 2024 Luxembourg

297 Rue de Reckenthal L-2410 Strassen, LUXEMBOURG

Court Nr.	1	Pool	1	Date	2024-06-08	Field Position	59
RED				BLUE			
NOC	RADJENOVIC NINA (SUI)			NOC	QUIRICI MELIKA (SUI)		
Category	Kumite Female Senior -61kg						
3 Points	2 Points	1 Point	Score	1 Point	2 Points	3 Points	
			0 : 4				
Penatlity				Penatlity			
C1: C3, C2:			0:4	C1: C3, C2:			
			Total	WINNER			

Decision of Superiority

Judge 1	Judge 2	Judge 3	Judge 4	Judge 5	Judge 6	Judge 7	Referee

Name _____

Signature _____

Lion Cup 2024 Luxembourg

297 Rue de Reckenthal L-2410 Strassen, LUXEMBOURG

Court Nr.	1	Pool	1	Date	2024-06-08	Field Position	61
RED				BLUE			
NOC	BOUGRINE AMEL (FRA)			NOC	HORSMANS JOANNA (NED)		
Category	Kumite Female Senior -61kg						
3 Points	2 Points	1 Point	Score	1 Point	2 Points	3 Points	
			5 : 0				
Penatlity				Penatlity			
C1: C2, C2:				5:0	C1: , C2:		
WINNER				Total			

Decision of Superiority

Judge 1	Judge 2	Judge 3	Judge 4	Judge 5	Judge 6	Judge 7	Referee

Name _____

Signature _____

Lion Cup 2024 Luxembourg

297 Rue de Reckenthal L-2410 Strassen, LUXEMBOURG

Court Nr.	1	Pool	1	Date	2024-06-08	Field Position	62
RED				BLUE			
NOC	QUIRICI MELIKA (SUI)			NOC	BURRI LILIANE (SUI)		
Category	Kumite Female Senior -61kg						
3 Points	2 Points	1 Point	Score	1 Point	2 Points	3 Points	
			5 : 0				
Penatlity				Penatlity			
C1: C1, C2:				5:0	C1: , C2:		
WINNER				Total			

Decision of Superiority

Judge 1	Judge 2	Judge 3	Judge 4	Judge 5	Judge 6	Judge 7	Referee

Name _____

Signature _____

Lion Cup 2024 Luxembourg

297 Rue de Reckenthal L-2410 Strassen, LUXEMBOURG

Court Nr.	1	Pool	1	Date	2024-06-08	Field Position	63
RED				BLUE			
NOC	BOUGRINE AMEL (FRA)			NOC	QUIRICI MELIKA (SUI)		
Category	Kumite Female Senior -61kg						
3 Points	2 Points	1 Point	Score	1 Point	2 Points	3 Points	
			4 : 4				
Penatlity					Penatlity		
C1: C2, C2:				4:4	C1: HC, C2:		
WINNER				Total			

Decision of Superiority

Judge 1	Judge 2	Judge 3	Judge 4	Judge 5	Judge 6	Judge 7	Referee

Name _____

Signature _____

Lion Cup 2024 Luxembourg

297 Rue de Reckenthal L-2410 Strassen, LUXEMBOURG

Court Nr.	1	Pool	1	Date	2024-06-08	Field Position	0	
RED				BLUE				
NOC	BOSSHARD LEA MARIE (SUI)			NOC	HORSMANS JOANNA (NED)			
Category	Kumite Female Senior -61kg							
3 Points	2 Points	1 Point	Score	1 Point	2 Points	3 Points		
			8 : 0					
Penatlity				Penatlity				
C1: C3, C2:				8:0	C1: C1, C2:			
WINNER				Total				

Decision of Superiority

Judge 1	Judge 2	Judge 3	Judge 4	Judge 5	Judge 6	Judge 7	Referee

Name _____

Signature _____

Lion Cup 2024 Luxembourg

297 Rue de Reckenthal L-2410 Strassen, LUXEMBOURG

Court Nr.	1	Pool	1	Date	2024-06-08	Field Position	2
RED				BLUE			
NOC	LANDMAN MEREL (NED)			NOC	BOSSHARD LEA MARIE (SUI)		
Category	Kumite Female Senior -61kg						
3 Points	2 Points	1 Point	Score	1 Point	2 Points	3 Points	
			:				
Penatlity				Penatlity			
			Total				

Decision of Superiority

Judge 1	Judge 2	Judge 3	Judge 4	Judge 5	Judge 6	Judge 7	Referee

Name _____

Signature _____

Lion Cup 2024 Luxembourg

297 Rue de Reckenthal L-2410 Strassen, LUXEMBOURG

Court Nr.	2	Pool	2	Date	2024-06-08	Field Position	0	
RED				BLUE				
NOC	RADJENOVIC NINA (SUI)			NOC	BURRI LILIANE (SUI)			
Category	Kumite Female Senior -61kg							
3 Points	2 Points	1 Point	Score	1 Point	2 Points	3 Points		
			6 : 1					
Penatlity				Penatlity				
C1: , C2:				6:1	C1: , C2:			
WINNER				Total				

Decision of Superiority

Judge 1	Judge 2	Judge 3	Judge 4	Judge 5	Judge 6	Judge 7	Referee

Name _____

Signature _____

Lion Cup 2024 Luxembourg

297 Rue de Reckenthal L-2410 Strassen, LUXEMBOURG

Court Nr.	2	Pool	2	Date	2024-06-08	Field Position	2
RED				BLUE			
NOC	LE MESTRE LARA (BEL)			NOC	RADJENOVIC NINA (SUI)		
Category	Kumite Female Senior -61kg						
3 Points	2 Points	1 Point	Score	1 Point	2 Points	3 Points	
			0 : 5				
Penatlity				Penatlity			
C1: , C2:			0:5	C1: , C2:			
			Total	WINNER			

Decision of Superiority

Judge 1	Judge 2	Judge 3	Judge 4	Judge 5	Judge 6	Judge 7	Referee

Name _____

Signature _____

Lion Cup 2024 Luxembourg - 2024-06-07

Official Results

Kumite Female Senior -61kg			
1	BOUGRINE AMEL		FRA - FRANCE
2	QUIRICI MELIKA		SUI - SWITZERLAND
3	BOSSHARD LEA MARIE		SUI - SWITZERLAND
3	RADJENOVIC NINA		SUI - SWITZERLAND
5	HORSMANS JOANNA		NED - NETHERLANDS
5	BURRI LILIANE		SUI - SWITZERLAND
7	LANDMAN MEREL		NED - NETHERLANDS
7	LE MESTRE LARA		BEL - BELGIUM

KUMITE FEMALE SENIOR -68KG

Lion Cup 2024 Luxembourg

ENTRIES BY WEIGHT CATEGORY
Kumite Female Senior -68kg

As of 8 JUN 2024

NOC Code	Gender	Name	Seeding
BEL	F	Vervoort Tess	
DEN	F	Aakerman Sarah Lundquist	
FRA	F	bougrine amina	
FRA	F	bougrine nesrine	
GER	F	Mielke Nele	
NED	F	Mamadeus Sennah	
NED	F	Snel Lynn	

Kumite Female Senior -68kg

Lion Cup 2024 Luxembourg, 297 Rue de Reckenthal L-2410 Strassen, LUX

2024-06-08

Tatami
5 09:20

Pool
1 / 1

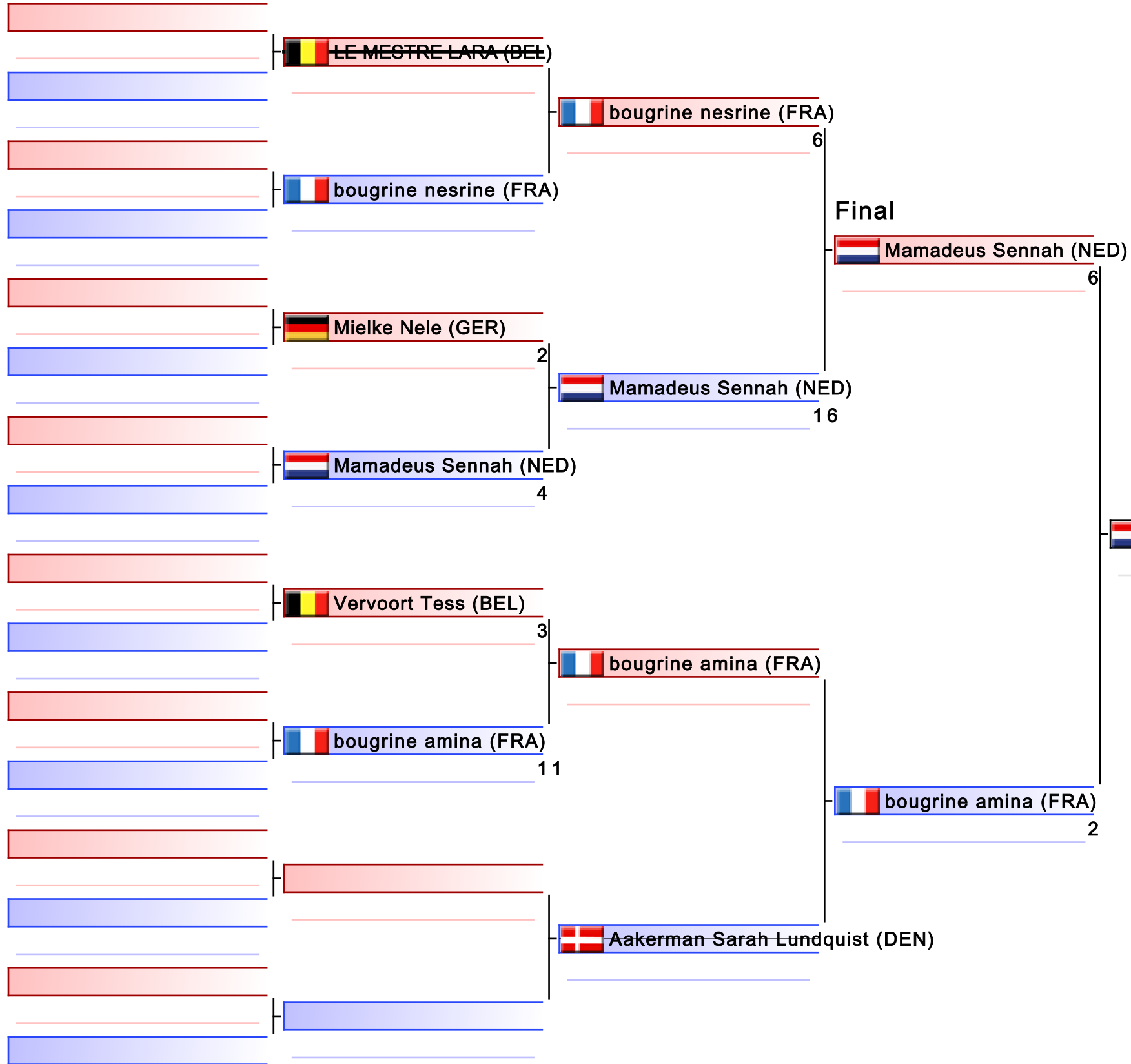

1. MAMADEUS SENNAH (NED)
2. BOUGRINE AMINA (FRA)
3. VERVOORT TESS (BEL)
3. BOUGRINE NESRINE (FRA)
5. MIELKE NELE (GER)

Kumite Female Senior -68kg

Lion Cup 2024 Luxembourg

2024-06-08

Tatami
5 09:50

Pool
1

(c)sportdata GmbH & Co KG 2000-2024 (2024-06-08 18:41) v 10.1.0 build 1 (2024-01-24 23:23 CET) License: Online_Event_ID-7672_LionCup2024Luxembourg (expire 2024-06-21)

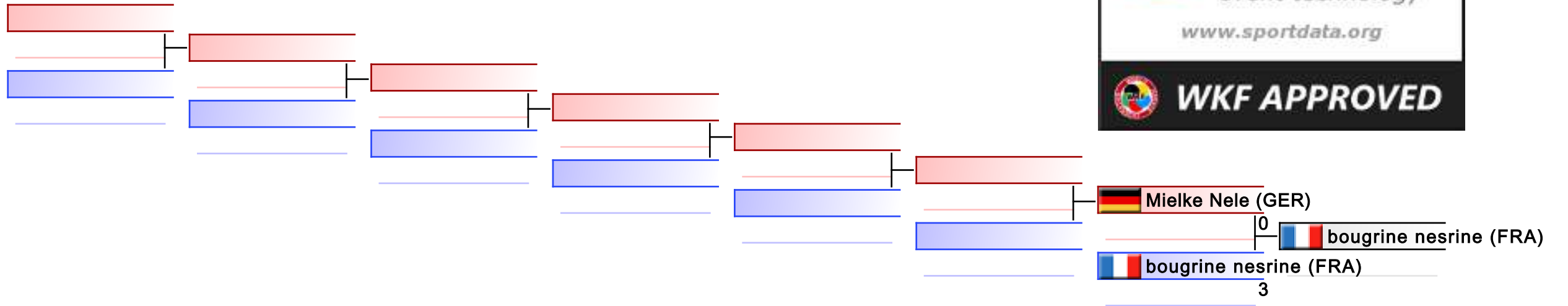

REPECHAGE: (1)

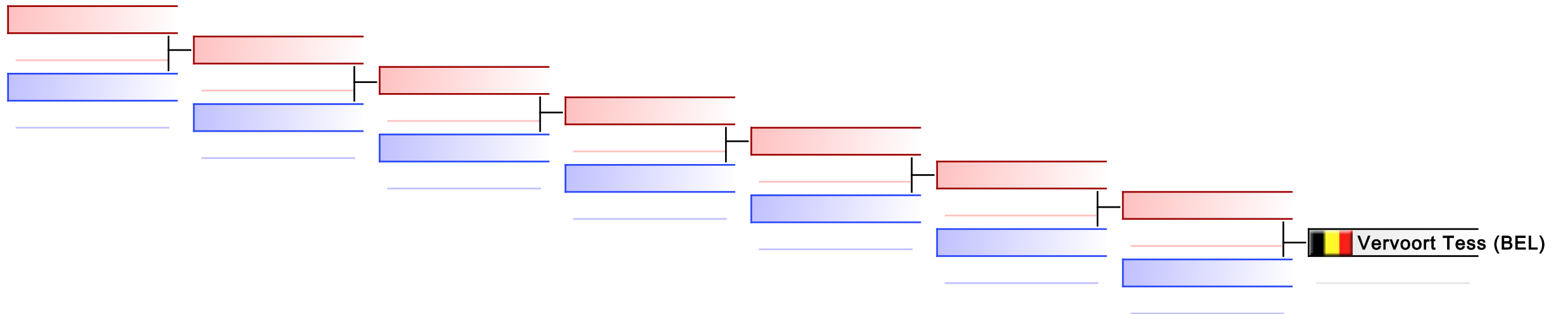

Lion Cup 2024 Luxembourg

297 Rue de Reckenthal L-2410 Strassen, LUXEMBOURG

Court Nr.	1	Pool	1	Date	2024-06-08	Field Position	58
RED				BLUE			
NOC	MIELKE NELE (GER)			NOC	MAMADEUS SENNAH (NED)		
Category	Kumite Female Senior -68kg						
3 Points	2 Points	1 Point	Score	1 Point	2 Points	3 Points	
			2 : 4				
Penatlity				Penatlity			
C1: C1, C2:			2:4	C1: C3, C2:			
			Total	WINNER			

Decision of Superiority

Judge 1	Judge 2	Judge 3	Judge 4	Judge 5	Judge 6	Judge 7	Referee

Name _____

Signature _____

Lion Cup 2024 Luxembourg

297 Rue de Reckenthal L-2410 Strassen, LUXEMBOURG

Court Nr.	1	Pool	1	Date	2024-06-08	Field Position	59
RED				BLUE			
NOC	VERVOORT TESS (BEL)			NOC	BOUGRINE AMINA (FRA)		
Category	Kumite Female Senior -68kg						
3 Points	2 Points	1 Point	Score	1 Point	2 Points	3 Points	
			3 : 11				
Penatlity				Penatlity			
C1: C2, C2:			3:11	C1: HC, C2:			
			Total	WINNER			

Decision of Superiority

Judge 1	Judge 2	Judge 3	Judge 4	Judge 5	Judge 6	Judge 7	Referee

Name _____

Signature _____

Lion Cup 2024 Luxembourg

297 Rue de Reckenthal L-2410 Strassen, LUXEMBOURG

Court Nr.	1	Pool	1	Date	2024-06-08	Field Position	61
RED				BLUE			
NOC	BOUGRINE NESRINE (FRA)			NOC	MAMADEUS SENNAH (NED)		
Category	Kumite Female Senior -68kg						
3 Points	2 Points	1 Point	Score	1 Point	2 Points	3 Points	
			6 : 16				
Penatlity				Penatlity			
C1: HC, C2:			6:16	C1: C2, C2:			
			Total	WINNER			

Decision of Superiority

Judge 1	Judge 2	Judge 3	Judge 4	Judge 5	Judge 6	Judge 7	Referee

Name _____

Signature _____

Lion Cup 2024 Luxembourg

297 Rue de Reckenthal L-2410 Strassen, LUXEMBOURG

Court Nr.	1	Pool	1	Date	2024-06-08	Field Position	63
RED				BLUE			
NOC	MAMADEUS SENNAH (NED)			NOC	BOUGRINE AMINA (FRA)		
Category	Kumite Female Senior -68kg						
3 Points	2 Points	1 Point	Score	1 Point	2 Points	3 Points	
			6 : 2				
Penatlity				Penatlity			
C1: C1, C2:			6:2	C1: C1, C2:			
WINNER			Total				

Decision of Superiority

Judge 1	Judge 2	Judge 3	Judge 4	Judge 5	Judge 6	Judge 7	Referee

Name _____

Signature _____

Lion Cup 2024 Luxembourg

297 Rue de Reckenthal L-2410 Strassen, LUXEMBOURG

Court Nr.	1	Pool	1	Date	2024-06-08	Field Position	0
RED				BLUE			
NOC	MIELKE NELE (GER)			NOC	BOUGRINE NESRINE (FRA)		
Category	Kumite Female Senior -68kg						
3 Points	2 Points	1 Point	Score	1 Point	2 Points	3 Points	
			:				
Penatlity				Penatlity			
			Total				

Decision of Superiority

Judge 1	Judge 2	Judge 3	Judge 4	Judge 5	Judge 6	Judge 7	Referee

Name _____

Signature _____

Official Results

Kumite Female Senior -68kg			
1	MAMADEUS SENNAH		NED - NETHERLANDS
2	BOUGRINE AMINA		FRA - FRANCE
3	VERVOORT TESS		BEL - BELGIUM
3	BOUGRINE NESRINE		FRA - FRANCE
5	MIELKE NELE		GER - GERMANY

KUMITE FEMALE U12 +40KG

Lion Cup 2024 Luxembourg

ENTRIES BY WEIGHT CATEGORY
Kumite Female U12 +40kg

As of 8 JUN 2024

NOC Code	Gender	Name	Seeding
BEL	F	Mansour Sonia	
BEL	F	Van de Velde Elhya	
BEL	F	Vekemans Luana	
FRA	F	Al Mouhajir Wiam	
FRA	F	Mazzoleni Naelys	
NED	F	Bohoudi Amani	
SUI	F	Aregger Leila	
SUI	F	Zecca Cassandra	

Kumite Female U12 +40kg

Lion Cup 2024 Luxembourg, 297 Rue de Reckenthal L-2410 Strassen, LUX

2024-06-08

Tatami

5 13:10

Pool

1 / 1

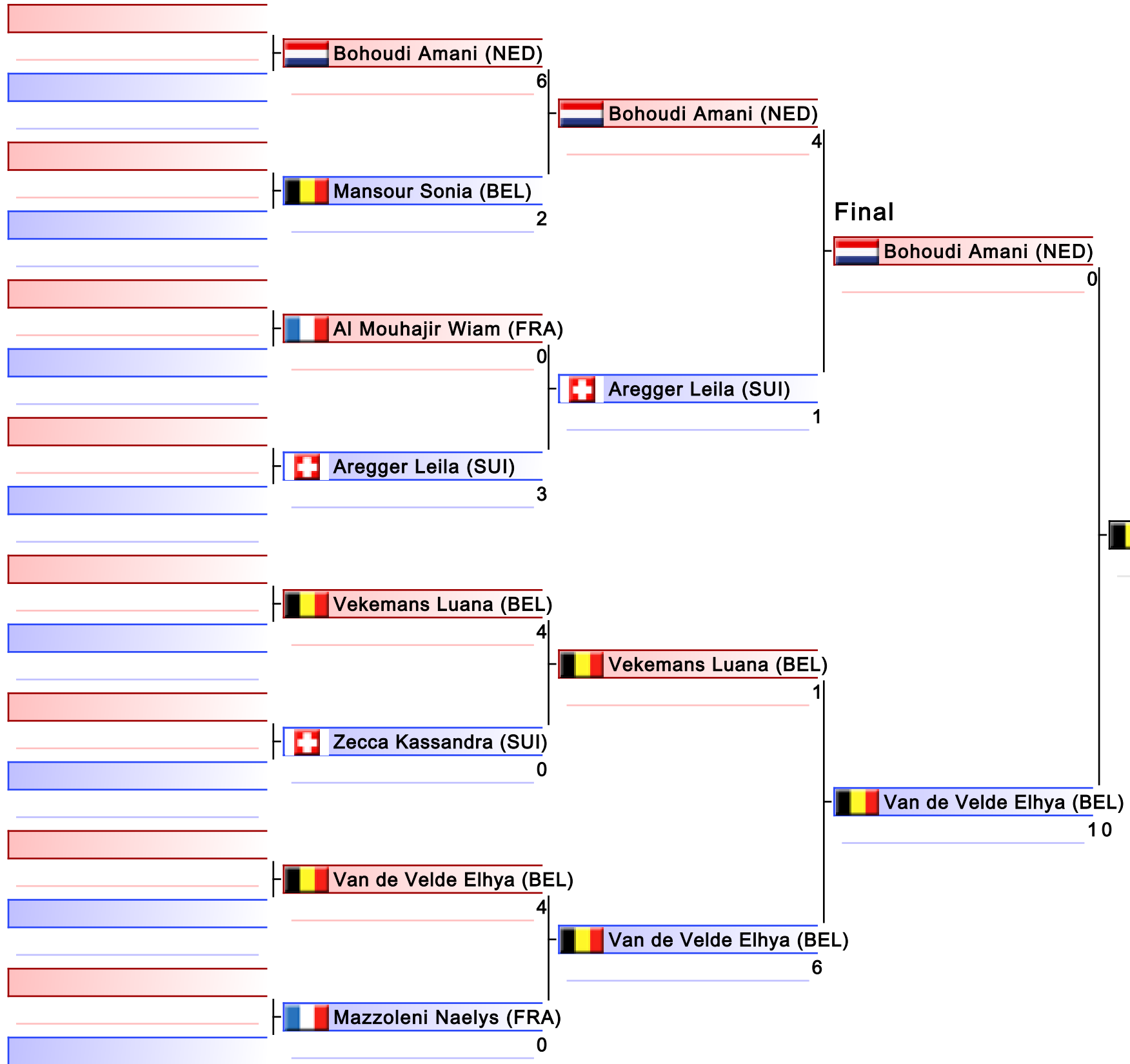

1. VAN DE VELDE ELHYA (BEL)
2. BOHOUDI AMANI (NED)
3. AREGGER LEILA (SUI)
3. VEKEMANS LUANA (BEL)
5. MANSOUR SONIA (BEL)
5. MAZZOLENI NAELYS (FRA)

Kumite Female U12 +40kg

Lion Cup 2024 Luxembourg

2024-06-08

Tatami
5 13:25

Pool
1

(c)sportdata GmbH & Co KG 2000-2024 (2024-06-08 18:41) v 10.1.0 build 1 (2024-01-24 23:23 CET) License: Online_Event_ID-7672_LionCup2024Luxembourg (expire 2024-06-21)

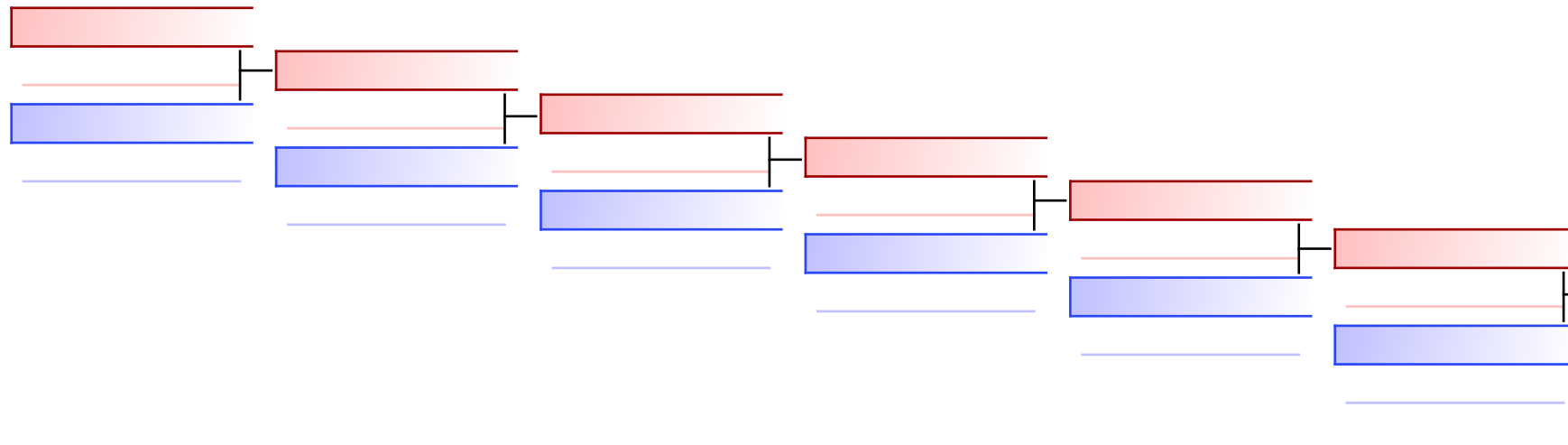

Mansour Sonia (BEL)
1
 Aregger Leila (SUI)
 Aregger Leila (SUI)
5

REPECHAGE: (1)

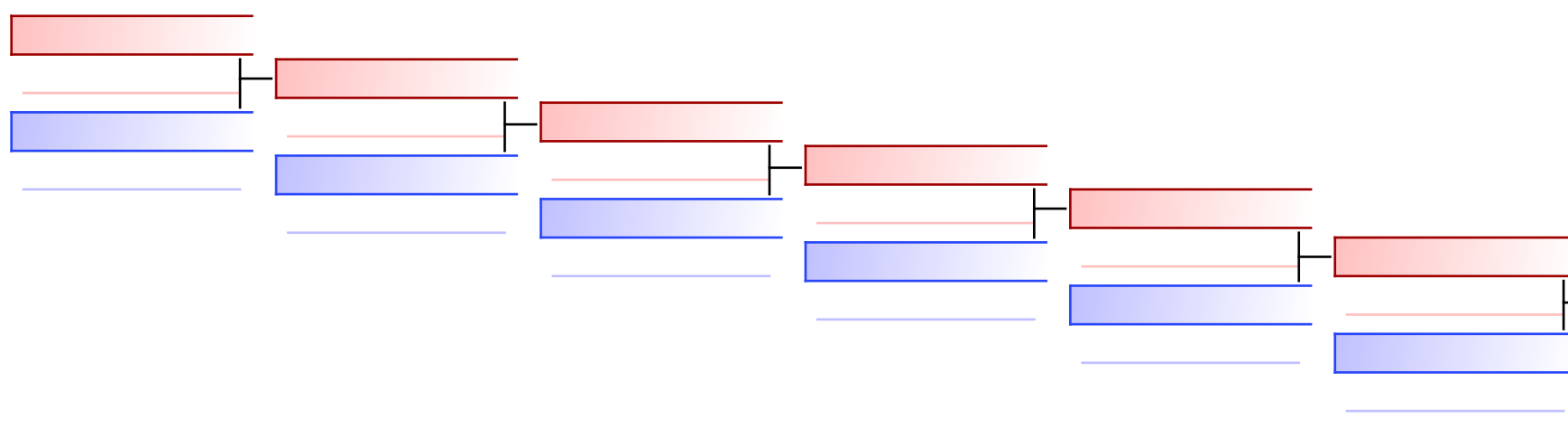

Mazzoleni Naelys (FRA)
0
 Vekemans Luana (BEL)
 Vekemans Luana (BEL)
3

Lion Cup 2024 Luxembourg

297 Rue de Reckenthal L-2410 Strassen, LUXEMBOURG

Court Nr.	1	Pool	1	Date	2024-06-08	Field Position	57	
RED				BLUE				
NOC	BOHOUDI AMANI (NED)			NOC	MANSOUR SONIA (BEL)			
Category	Kumite Female U12 +40kg							
3 Points	2 Points	1 Point	Score	1 Point	2 Points	3 Points		
			6 : 2					
Penatlity				Penatlity				
C1: HC, C2:				6:2	C1: C2, C2:			
WINNER				Total				

Decision of Superiority

Judge 1	Judge 2	Judge 3	Judge 4	Judge 5	Judge 6	Judge 7	Referee

Name _____

Signature _____

Lion Cup 2024 Luxembourg

297 Rue de Reckenthal L-2410 Strassen, LUXEMBOURG

Court Nr.	1	Pool	1	Date	2024-06-08	Field Position	58
RED				BLUE			
NOC	AL MOUHAJIR WIAM (FRA)			NOC	AREGGER LEILA (SUI)		
Category	Kumite Female U12 +40kg						
3 Points	2 Points	1 Point	Score	1 Point	2 Points	3 Points	
			0 : 3				
Penatlity				Penatlity			
C1: , C2:				0:3	C1: , C2:		
				Total	WINNER		

Decision of Superiority

Judge 1	Judge 2	Judge 3	Judge 4	Judge 5	Judge 6	Judge 7	Referee

Name _____

Signature _____

Lion Cup 2024 Luxembourg

297 Rue de Reckenthal L-2410 Strassen, LUXEMBOURG

Court Nr.	1	Pool	1	Date	2024-06-08	Field Position	59	
RED				BLUE				
NOC	VEKEMANS LUANA (BEL)			NOC	ZECCA KASSANDRA (SUI)			
Category	Kumite Female U12 +40kg							
3 Points	2 Points	1 Point	Score	1 Point	2 Points	3 Points		
			4 : 0					
Penatlity				Penatlity				
C1: , C2:				4:0	C1: C1, C2:			
WINNER				Total				

Decision of Superiority

Judge 1	Judge 2	Judge 3	Judge 4	Judge 5	Judge 6	Judge 7	Referee

Name _____

Signature _____

Lion Cup 2024 Luxembourg

297 Rue de Reckenthal L-2410 Strassen, LUXEMBOURG

Court Nr.	1	Pool	1	Date	2024-06-08	Field Position	60
RED				BLUE			
NOC	VAN DE VELDE ELHYA (BEL)			NOC	MAZZOLENI NAELYS (FRA)		
Category	Kumite Female U12 +40kg						
3 Points	2 Points	1 Point	Score	1 Point	2 Points	3 Points	
			4 : 0				
Penatlity				Penatlity			
C1: C2, C2:				4:0	C1: , C2:		
WINNER				Total			

Decision of Superiority

Judge 1	Judge 2	Judge 3	Judge 4	Judge 5	Judge 6	Judge 7	Referee

Name _____

Signature _____

Lion Cup 2024 Luxembourg

297 Rue de Reckenthal L-2410 Strassen, LUXEMBOURG

Court Nr.	1	Pool	1	Date	2024-06-08	Field Position	61
RED				BLUE			
NOC	BOHOUDI AMANI (NED)			NOC	AREGGER LEILA (SUI)		
Category	Kumite Female U12 +40kg						
3 Points	2 Points	1 Point	Score	1 Point	2 Points	3 Points	
			4 : 1				
Penatlity				Penatlity			
C1: , C2:			4:1	C1: , C2:			
WINNER			Total				

Decision of Superiority

Judge 1	Judge 2	Judge 3	Judge 4	Judge 5	Judge 6	Judge 7	Referee

Name _____

Signature _____

Lion Cup 2024 Luxembourg

297 Rue de Reckenthal L-2410 Strassen, LUXEMBOURG

Court Nr.	1	Pool	1	Date	2024-06-08	Field Position	62
RED				BLUE			
NOC	VEKEMANS LUANA (BEL)			NOC	VAN DE VELDE ELHYA (BEL)		
Category	Kumite Female U12 +40kg						
3 Points	2 Points	1 Point	Score	1 Point	2 Points	3 Points	
			1 : 6				
Penatlity				Penatlity			
C1: C1, C2:			1:6	C1: C3, C2:			
			Total	WINNER			

Decision of Superiority

Judge 1	Judge 2	Judge 3	Judge 4	Judge 5	Judge 6	Judge 7	Referee

Name _____

Signature _____

Lion Cup 2024 Luxembourg

297 Rue de Reckenthal L-2410 Strassen, LUXEMBOURG

Court Nr.	1	Pool	1	Date	2024-06-08	Field Position	63
RED				BLUE			
NOC	BOHOUDI AMANI (NED)			NOC	VAN DE VELDE ELHYA (BEL)		
Category	Kumite Female U12 +40kg						
3 Points	2 Points	1 Point	Score	1 Point	2 Points	3 Points	
			0 : 10				
Penatlity				Penatlity			
C1: , C2:			0:10	C1: C1, C2:			
			Total	WINNER			

Decision of Superiority

Judge 1	Judge 2	Judge 3	Judge 4	Judge 5	Judge 6	Judge 7	Referee

Name _____

Signature _____

Lion Cup 2024 Luxembourg

297 Rue de Reckenthal L-2410 Strassen, LUXEMBOURG

Court Nr.	1	Pool	1	Date	2024-06-08	Field Position	0
RED				BLUE			
NOC	MANSOUR SONIA (BEL)			NOC	AREGGER LEILA (SUI)		
Category	Kumite Female U12 +40kg						
3 Points	2 Points	1 Point	Score	1 Point	2 Points	3 Points	
			:				
Penatlity				Penatlity			
			Total				

Decision of Superiority

Judge 1	Judge 2	Judge 3	Judge 4	Judge 5	Judge 6	Judge 7	Referee

Name _____

Signature _____

Lion Cup 2024 Luxembourg

297 Rue de Reckenthal L-2410 Strassen, LUXEMBOURG

Court Nr.	2	Pool	2	Date	2024-06-08	Field Position	0	
RED				BLUE				
NOC	MAZZOLENI NAELYS (FRA)			NOC	VEKEMANS LUANA (BEL)			
Category	Kumite Female U12 +40kg							
3 Points	2 Points	1 Point	Score	1 Point	2 Points	3 Points		
			0 : 3					
Penatlity				Penatlity				
C1: C1, C2:				0:3	C1: HC, C2:			
				Total	WINNER			

Decision of Superiority

Judge 1	Judge 2	Judge 3	Judge 4	Judge 5	Judge 6	Judge 7	Referee

Name _____

Signature _____

Official Results

Kumite Female U12 +40kg			
1	VAN DE VELDE ELHYA		BEL - BELGIUM
2	BOHOUDI AMANI		NED - NETHERLANDS
3	AREGGER LEILA		SUI - SWITZERLAND
3	VEKEMANS LUANA		BEL - BELGIUM
5	MANSOUR SONIA		BEL - BELGIUM
5	MAZZOLENI NAELYS		FRA - FRANCE

KUMITE FEMALE U12 -35KG

Lion Cup 2024 Luxembourg

ENTRIES BY WEIGHT CATEGORY
Kumite Female U12 -35kg

As of 8 JUN 2024

NOC Code	Gender	Name	Seeding
BEL	F	MAATOUG Meryame	
LUX	F	Durrer Maya	
LUX	F	Fonseca Lara	
LUX	F	Moens Adele	
LUX	F	Serra Rodrigues Ines	
NED	F	Lućkin Ajla	
NED	F	Nassiri Lyna	
SUI	F	Boutracit Marwa	

Kumite Female U12 -35kg

Lion Cup 2024 Luxembourg, 297 Rue de Reckenthal L-2410 Strassen, LUX

2024-06-08

Tatami
6 13:10

Pool
1 / 1

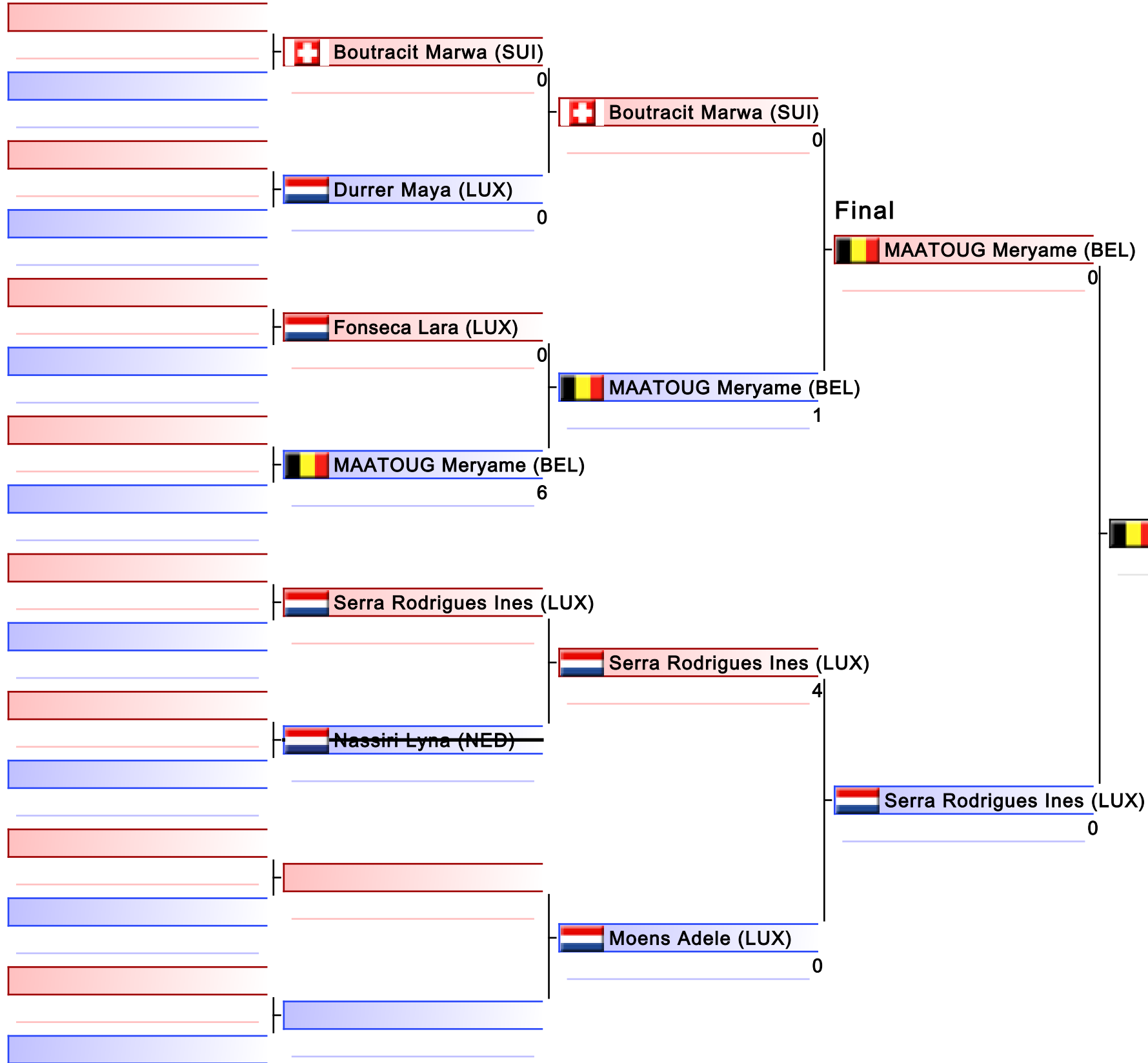

1. MAATOUG MERYAME (BEL)
2. SERRA RODRIGUES INES (LUX)
3. MOENS ADELE (LUX)
3. BOUTRACIT MARWA (SUI)
5. FONSECA LARA (LUX)

Kumite Female U12 -35kg

Lion Cup 2024 Luxembourg

2024-06-08

Tatami
6 13:25

Pool
1

(c)sportdata GmbH & Co KG 2000-2024 (2024-06-08 18:41) v 10.1.0 build 1 (2024-01-24 23:23 CET) License: Online_Event_ID-7672_LionCup2024Luxembourg (expire 2024-06-21)

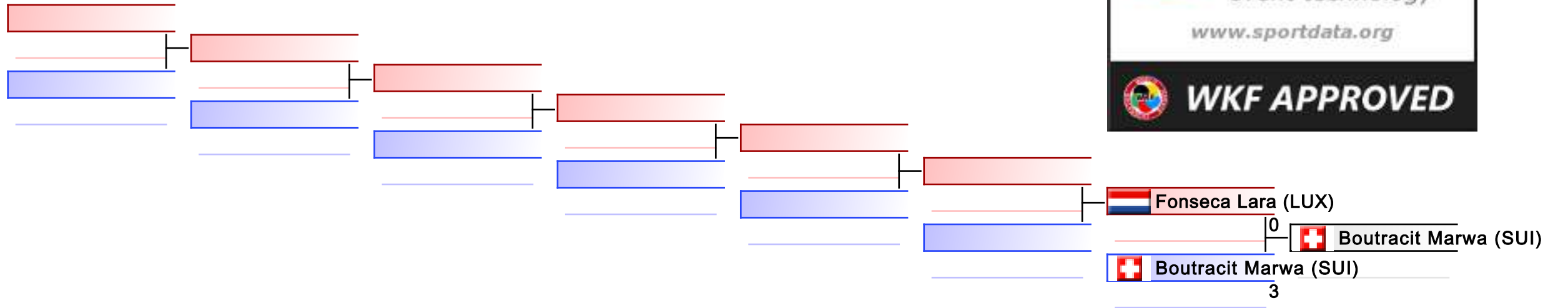

REPECHAGE: (1)

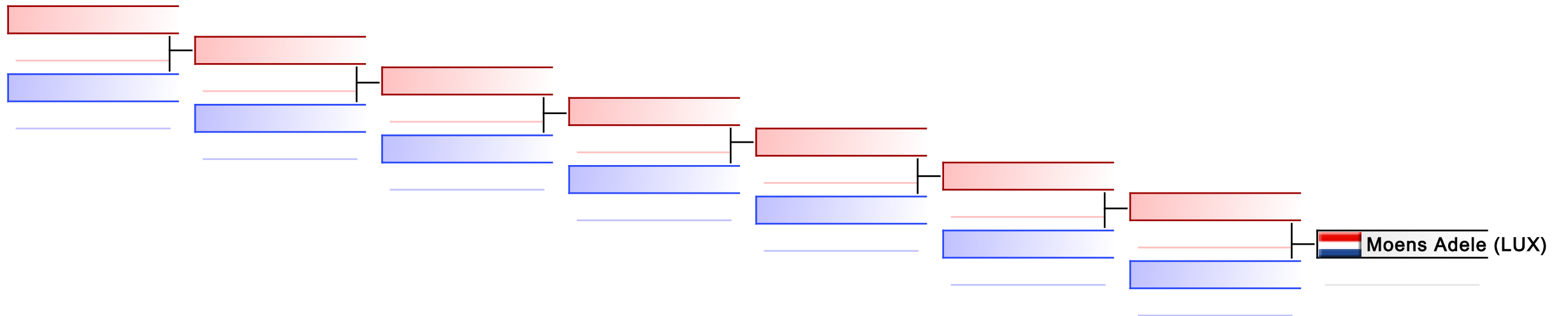

Lion Cup 2024 Luxembourg

297 Rue de Reckenthal L-2410 Strassen, LUXEMBOURG

Court Nr.	1	Pool	1	Date	2024-06-08	Field Position	57	
RED				BLUE				
NOC	BOUTRACIT MARWA (SUI)			NOC	DURRER MAYA (LUX)			
Category	Kumite Female U12 -35kg							
3 Points	2 Points	1 Point	Score	1 Point	2 Points	3 Points		
			0 : 0					
Penatlity				Penatlity				
C1: C3, C2:				0:0	C1: C2, C2:			
WINNER				Total				

Decision of Superiority

Judge 1	Judge 2	Judge 3	Judge 4	Judge 5	Judge 6	Judge 7	Referee

Name _____

Signature _____

Lion Cup 2024 Luxembourg

297 Rue de Reckenthal L-2410 Strassen, LUXEMBOURG

Court Nr.	1	Pool	1	Date	2024-06-08	Field Position	58
RED				BLUE			
NOC	FONSECA LARA (LUX)			NOC	MAATOUG MERYAME (BEL)		
Category	Kumite Female U12 -35kg						
3 Points	2 Points	1 Point	Score	1 Point	2 Points	3 Points	
			0 : 6				
Penatlity				Penatlity			
C1: , C2:				0:6	C1: , C2:		
				Total	WINNER		

Decision of Superiority

Judge 1	Judge 2	Judge 3	Judge 4	Judge 5	Judge 6	Judge 7	Referee

Name _____

Signature _____

Lion Cup 2024 Luxembourg

297 Rue de Reckenthal L-2410 Strassen, LUXEMBOURG

Court Nr.	1	Pool	1	Date	2024-06-08	Field Position	61
RED				BLUE			
NOC	BOUTRACIT MARWA (SUI)			NOC	MAATOUG MERYAME (BEL)		
Category	Kumite Female U12 -35kg						
3 Points	2 Points	1 Point	Score	1 Point	2 Points	3 Points	
			0 : 1				
Penatlity				Penatlity			
C1: , C2:				0:1	C1: C3, C2:		
				Total	WINNER		

Decision of Superiority

Judge 1	Judge 2	Judge 3	Judge 4	Judge 5	Judge 6	Judge 7	Referee

Name _____

Signature _____

Lion Cup 2024 Luxembourg

297 Rue de Reckenthal L-2410 Strassen, LUXEMBOURG

Court Nr.	1	Pool	1	Date	2024-06-08	Field Position	62
RED				BLUE			
NOC	SERRA RODRIGUES INES (LUX)			NOC	MOENS ADELE (LUX)		
Category	Kumite Female U12 -35kg						
3 Points	2 Points	1 Point	Score	1 Point	2 Points	3 Points	
			4 : 0				
Penatlity				Penatlity			
C1: , C2:				4:0	C1: C2, C2:		
WINNER				Total			

Decision of Superiority

Judge 1	Judge 2	Judge 3	Judge 4	Judge 5	Judge 6	Judge 7	Referee

Name _____

Signature _____

Lion Cup 2024 Luxembourg

297 Rue de Reckenthal L-2410 Strassen, LUXEMBOURG

Court Nr.	1	Pool	1	Date	2024-06-08	Field Position	63
RED				BLUE			
NOC	MAATOUG MERYAME (BEL)			NOC	SERRA RODRIGUES INES (LUX)		
Category	Kumite Female U12 -35kg						
3 Points	2 Points	1 Point	Score	1 Point	2 Points	3 Points	
			0 : 0				
Penatlity				Penatlity			
C1: C1, C2:				0:0	C1: , C2:		
WINNER				Total			

Decision of Superiority

Judge 1	Judge 2	Judge 3	Judge 4	Judge 5	Judge 6	Judge 7	Referee

Name _____

Signature _____

Lion Cup 2024 Luxembourg

297 Rue de Reckenthal L-2410 Strassen, LUXEMBOURG

Court Nr.	1	Pool	1	Date	2024-06-08	Field Position	0
RED				BLUE			
NOC	FONSECA LARA (LUX)			NOC	BOUTRACIT MARWA (SUI)		
Category	Kumite Female U12 -35kg						
3 Points	2 Points	1 Point	Score	1 Point	2 Points	3 Points	
			:				
Penatlity				Penatlity			
			Total				

Decision of Superiority

Judge 1	Judge 2	Judge 3	Judge 4	Judge 5	Judge 6	Judge 7	Referee

Name _____

Signature _____

Official Results

Kumite Female U12 -35kg			
1	MAATOUG MERYAME		BEL - BELGIUM
2	SERRA RODRIGUES INES		LUX - LUXEMBOURG
3	MOENS ADELE		LUX - LUXEMBOURG
3	BOUTRACIT MARWA		SUI - SWITZERLAND
5	FONSECA LARA		LUX - LUXEMBOURG

KUMITE FEMALE U12 -40KG

Lion Cup 2024 Luxembourg

ENTRIES BY WEIGHT CATEGORY
Kumite Female U12 -40kg

As of 8 JUN 2024

NOC Code	Gender	Name	Seeding
BEL	F	EL HOUDIFI Esmā	
FRA	F	Bouhraoua Loubna	
FRA	F	Zanoun Keyla	
GER	F	Baumgärtner Lena	
LUX	F	CUSTODERO Sara	
LUX	F	Rusovici Catalina	
LUX	F	Taibi Nuria	
NED	F	Kashash Sham	
SUI	F	Payziner Asya	

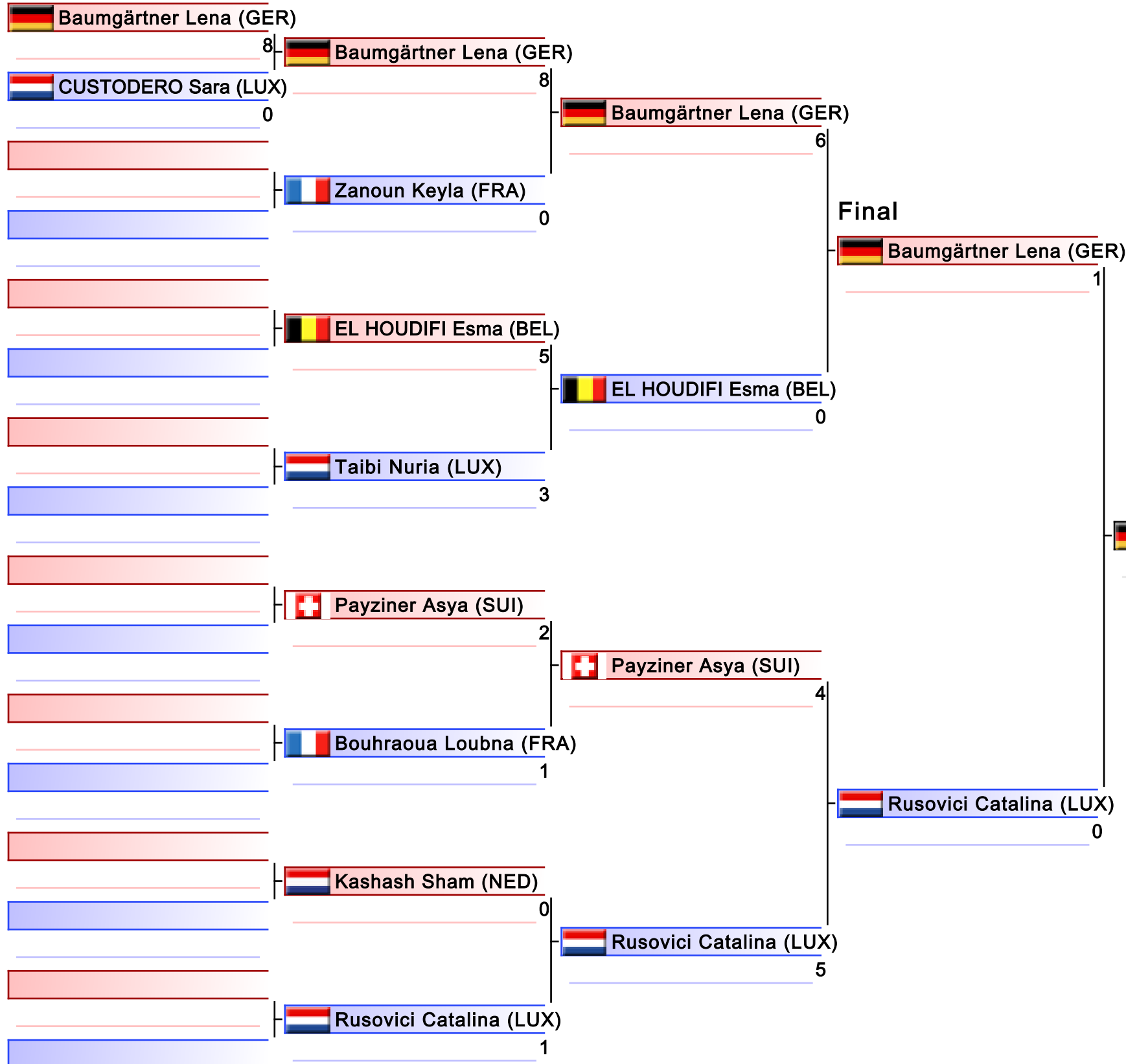

1. BAUMGÄRTNER LENA (GER)
2. RUSOVICI CATALINA (LUX)
3. PAYZINER ASYA (SUI)
3. EL HOUDIFI ESMA (BEL)
5. KASHASH SHAM (NED)
5. ZANOUN KEYLA (FRA)
7. CUSTODERO SARA (LUX)

Kumite Female U12 -40kg

Lion Cup 2024 Luxembourg

2024-06-08

Tatami
5 13:55

Pool
1

(c)sportdata GmbH & Co KG 2000-2024 (2024-06-08 18:41) v 10.1.0 build 1 (2024-01-24 23:23 CET) License: Online_Event_ID-7672_LionCup2024Luxembourg (expire 2024-06-21)

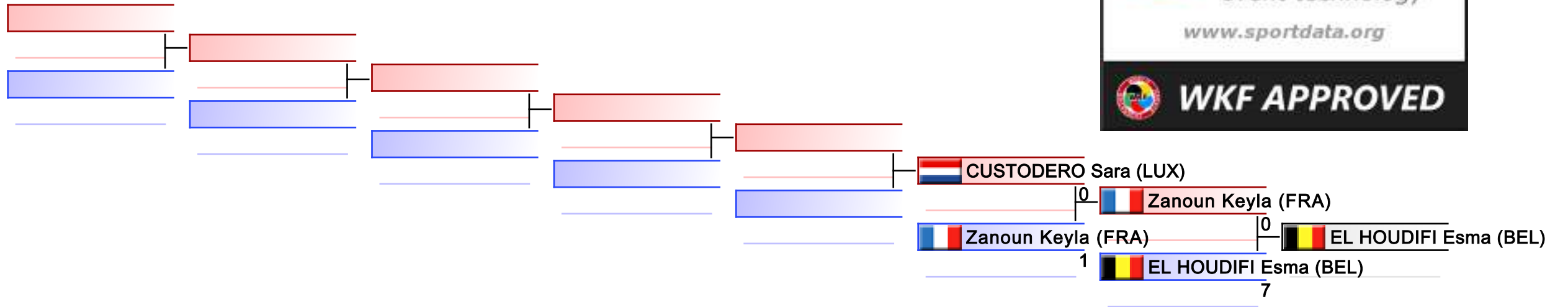

REPECHAGE: (1)

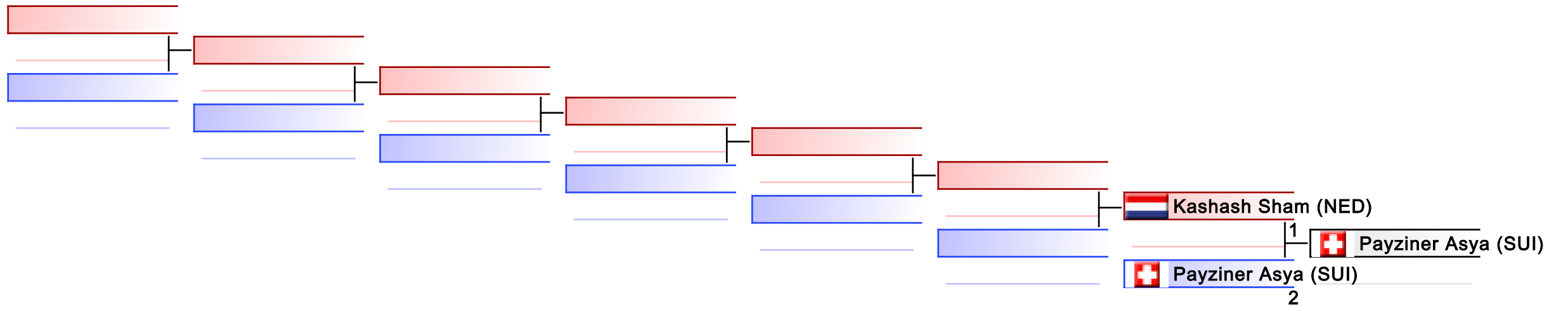

Lion Cup 2024 Luxembourg

297 Rue de Reckenthal L-2410 Strassen, LUXEMBOURG

Court Nr.	1	Pool	1	Date	2024-06-08	Field Position	49	
RED				BLUE				
NOC	BAUMGRTNER LENA (GER)			NOC	CUSTODERO SARA (LUX)			
Category	Kumite Female U12 -40kg							
3 Points	2 Points	1 Point	Score	1 Point	2 Points	3 Points		
			8 : 0					
Penatlity				Penatlity				
C1: , C2:				8:0	C1: , C2:			
WINNER				Total				

Decision of Superiority

Judge 1	Judge 2	Judge 3	Judge 4	Judge 5	Judge 6	Judge 7	Referee

Name _____

Signature _____

Lion Cup 2024 Luxembourg

297 Rue de Reckenthal L-2410 Strassen, LUXEMBOURG

Court Nr.	1	Pool	1	Date	2024-06-08	Field Position	57
RED				BLUE			
NOC	BAUMGRTNER LENA (GER)			NOC	ZANOUN KEYLA (FRA)		
Category	Kumite Female U12 -40kg						
3 Points	2 Points	1 Point	Score	1 Point	2 Points	3 Points	
			8 : 0				
Penatlity				Penatlity			
C1: C1, C2:				8:0	C1: , C2:		
WINNER				Total			

Decision of Superiority

Judge 1	Judge 2	Judge 3	Judge 4	Judge 5	Judge 6	Judge 7	Referee

Name _____

Signature _____

Lion Cup 2024 Luxembourg

297 Rue de Reckenthal L-2410 Strassen, LUXEMBOURG

Court Nr.	1	Pool	1	Date	2024-06-08	Field Position	58
RED				BLUE			
NOC	EL HOUDIFI ESMA (BEL)			NOC	TAIBI NURIA (LUX)		
Category	Kumite Female U12 -40kg						
3 Points	2 Points	1 Point	Score	1 Point	2 Points	3 Points	
			5 : 3				
Penatlity				Penatlity			
C1: C1, C2:				5:3	C1: , C2:		
WINNER				Total			

Decision of Superiority

Judge 1	Judge 2	Judge 3	Judge 4	Judge 5	Judge 6	Judge 7	Referee

Name _____

Signature _____

Lion Cup 2024 Luxembourg

297 Rue de Reckenthal L-2410 Strassen, LUXEMBOURG

Court Nr.	1	Pool	1	Date	2024-06-08	Field Position	59
RED				BLUE			
NOC	PAYZINER ASYA (SUI)			NOC	BOUHRAOUA LOUBNA (FRA)		
Category	Kumite Female U12 -40kg						
3 Points	2 Points	1 Point	Score	1 Point	2 Points	3 Points	
			2 : 1				
Penatlity				Penatlity			
C1: C2, C2:			2:1	C1: C1, C2:			
WINNER			Total				

Decision of Superiority

Judge 1	Judge 2	Judge 3	Judge 4	Judge 5	Judge 6	Judge 7	Referee

Name _____

Signature _____

Lion Cup 2024 Luxembourg

297 Rue de Reckenthal L-2410 Strassen, LUXEMBOURG

Court Nr.	1	Pool	1	Date	2024-06-08	Field Position	60
RED				BLUE			
NOC	KASHASH SHAM (NED)			NOC	RUSOVICI CATALINA (LUX)		
Category	Kumite Female U12 -40kg						
3 Points	2 Points	1 Point	Score	1 Point	2 Points	3 Points	
			0 : 1				
Penatlity				Penatlity			
C1: C2, C2:				0:1	C1: C1, C2:		
				Total	WINNER		

Decision of Superiority

Judge 1	Judge 2	Judge 3	Judge 4	Judge 5	Judge 6	Judge 7	Referee

Name _____

Signature _____

Lion Cup 2024 Luxembourg

297 Rue de Reckenthal L-2410 Strassen, LUXEMBOURG

Court Nr.	1	Pool	1	Date	2024-06-08	Field Position	61	
RED				BLUE				
NOC	BAUMGRTNER LENA (GER)			NOC	EL HOUDIFI ESMA (BEL)			
Category	Kumite Female U12 -40kg							
3 Points	2 Points	1 Point	Score	1 Point	2 Points	3 Points		
			6 : 0					
Penatlity				Penatlity				
C1: , C2:				6:0	C1: , C2:			
WINNER				Total				

Decision of Superiority

Judge 1	Judge 2	Judge 3	Judge 4	Judge 5	Judge 6	Judge 7	Referee

Name _____

Signature _____

Lion Cup 2024 Luxembourg

297 Rue de Reckenthal L-2410 Strassen, LUXEMBOURG

Court Nr.	1	Pool	1	Date	2024-06-08	Field Position	62
RED				BLUE			
NOC	PAYZINER ASYA (SUI)			NOC	RUSOVICI CATALINA (LUX)		
Category	Kumite Female U12 -40kg						
3 Points	2 Points	1 Point	Score	1 Point	2 Points	3 Points	
			4 : 5				
Penatlity					Penatlity		
C1: C1, C2:				4:5	C1: , C2:		
				Total	WINNER		

Decision of Superiority

Judge 1	Judge 2	Judge 3	Judge 4	Judge 5	Judge 6	Judge 7	Referee

Name _____

Signature _____

Lion Cup 2024 Luxembourg

297 Rue de Reckenthal L-2410 Strassen, LUXEMBOURG

Court Nr.	1	Pool	1	Date	2024-06-08	Field Position	63
RED				BLUE			
NOC	BAUMGRTNER LENA (GER)			NOC	RUSOVICI CATALINA (LUX)		
Category	Kumite Female U12 -40kg						
3 Points	2 Points	1 Point	Score	1 Point	2 Points	3 Points	
			1 : 0				
Penatlity				Penatlity			
C1: C1, C2:				1:0	C1: , C2:		
WINNER				Total			

Decision of Superiority

Judge 1	Judge 2	Judge 3	Judge 4	Judge 5	Judge 6	Judge 7	Referee

Name _____

Signature _____

Lion Cup 2024 Luxembourg

297 Rue de Reckenthal L-2410 Strassen, LUXEMBOURG

Court Nr.	1	Pool	1	Date	2024-06-08	Field Position	0
RED				BLUE			
NOC	ZANOUN KEYLA (FRA)			NOC	EL HOUDIFI ESMA (BEL)		
Category	Kumite Female U12 -40kg						
3 Points	2 Points	1 Point	Score	1 Point	2 Points	3 Points	
			0 : 7				
Penatlity				Penatlity			
C1: C2, C2:				0:7	C1: , C2:		
				Total	WINNER		

Decision of Superiority

Judge 1	Judge 2	Judge 3	Judge 4	Judge 5	Judge 6	Judge 7	Referee

Name _____

Signature _____

Lion Cup 2024 Luxembourg

297 Rue de Reckenthal L-2410 Strassen, LUXEMBOURG

Court Nr.	1	Pool	1	Date	2024-06-08	Field Position	2
RED				BLUE			
NOC	CUSTODERO SARA (LUX)			NOC	ZANOUN KEYLA (FRA)		
Category	Kumite Female U12 -40kg						
3 Points	2 Points	1 Point	Score	1 Point	2 Points	3 Points	
			:				
Penatlity				Penatlity			
			Total				

Decision of Superiority

Judge 1	Judge 2	Judge 3	Judge 4	Judge 5	Judge 6	Judge 7	Referee

Name _____

Signature _____

Lion Cup 2024 Luxembourg

297 Rue de Reckenthal L-2410 Strassen, LUXEMBOURG

Court Nr.	2	Pool	2	Date	2024-06-08	Field Position	0
RED				BLUE			
NOC	KASHASH SHAM (NED)			NOC	PAYZINER ASYA (SUI)		
Category	Kumite Female U12 -40kg						
3 Points	2 Points	1 Point	Score	1 Point	2 Points	3 Points	
			1 : 2				
Penatlity				Penatlity			
C1: , C2:			1:2	C1: C2, C2:			
			Total	WINNER			

Decision of Superiority

Judge 1	Judge 2	Judge 3	Judge 4	Judge 5	Judge 6	Judge 7	Referee

Name _____

Signature _____

Official Results

Kumite Female U12 -40kg			
1	BAUMGÄRTNER LENA		GER - GERMANY
2	RUSOVICI CATALINA		LUX - LUXEMBOURG
3	PAYZINER ASYA		SUI - SWITZERLAND
3	EL HOUDIFI ESMA		BEL - BELGIUM
5	KASHASH SHAM		NED - NETHERLANDS
5	ZANOUN KEYLA		FRA - FRANCE
7	CUSTODERO SARA		LUX - LUXEMBOURG

KUMITE FEMALE U16 -47KG

Lion Cup 2024 Luxembourg

ENTRIES BY WEIGHT CATEGORY
Kumite Female U16 -47kg

As of 8 JUN 2024

NOC Code	Gender	Name	Seeding
ALG	F	BELLATRECHE NOORHANE INES	
ALG	F	SADAoui MERYEM LOUDJEYN	
ALG	F	YAICHE CELIA	
BEL	F	angela raskin	
BEL	F	Moons Cruz Mayla	
BEL	F	PATRUNSU DENISA	
BEL	F	SMIDTS Giulia	
FRA	F	BERGER Alicia	
FRA	F	KOUME Lee-Lou	
LUX	F	Coquillard Elise	
LUX	F	Kieffer Lynn	
NED	F	Achghouyab Lyna	
NED	F	Lepez Darla	
NED	F	Mezraui Dounia Sofia	
SUI	F	Frischknecht Jessica	
SUI	F	Gerber Yara	
SUI	F	Oymak Almina	
SUI	F	Payziner Serena	
SUI	F	Sellami Inshirah	
SUI	F	Streit Mila Chiara	
SUI	F	von Klass Melissa	
SUI	F	Özdemir Demet	

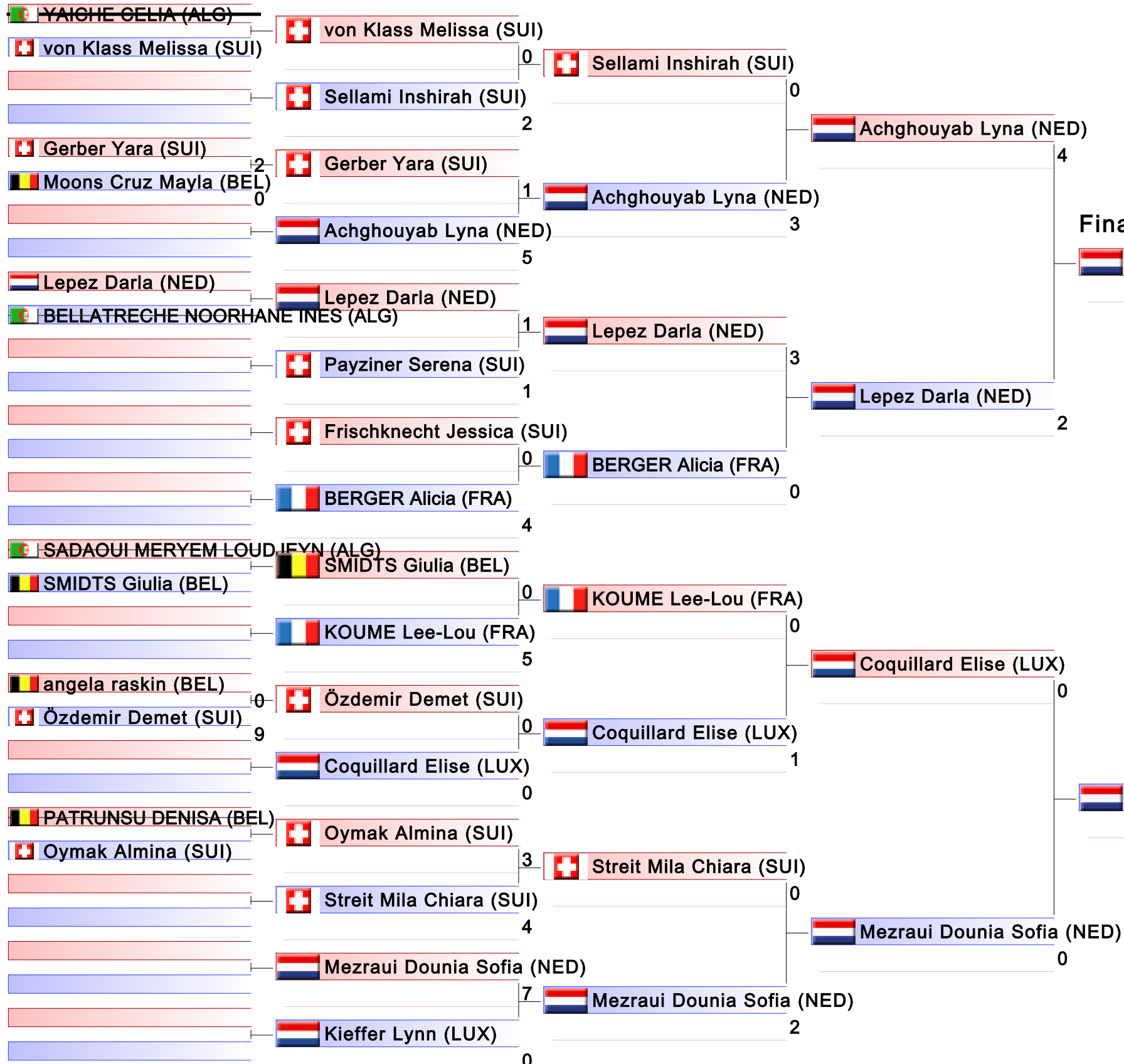

1. MEZRAUI DOUNIA SOFIA (NED)
2. ACHGHOUYAB LYNA (NED)
3. LEPEZ DARLA (NED)
3. COQUILLARD ELISE (LUX)
5. GERBER YARA (SUI)
5. STREIT MILA CHIARA (SUI)
7. SELLAMI INSHIRAH (SUI)
7. KIEFFER LYNN (LUX)

Kumite Female U16 -47kg

Lion Cup 2024 Luxembourg

2024-06-08

Tatami
6 16:55

Pool
1

(c)sportdata GmbH & Co KG 2000-2024 (2024-06-08 18:41) v 10.1.0 build 1 (2024-01-24 23:23 CET) License: Online_Event_ID-7672_LionCup2024Luxembourg (expire 2024-06-21)

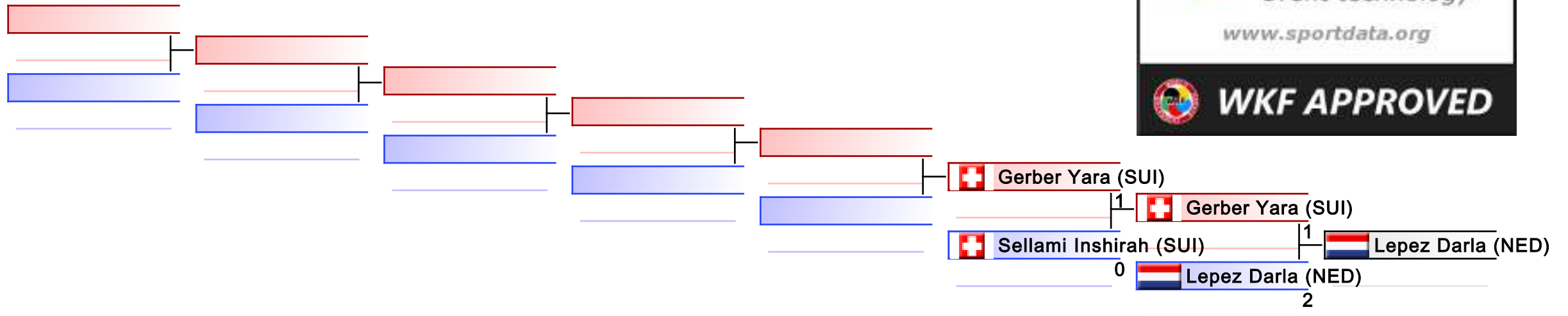

REPECHAGE: (1)

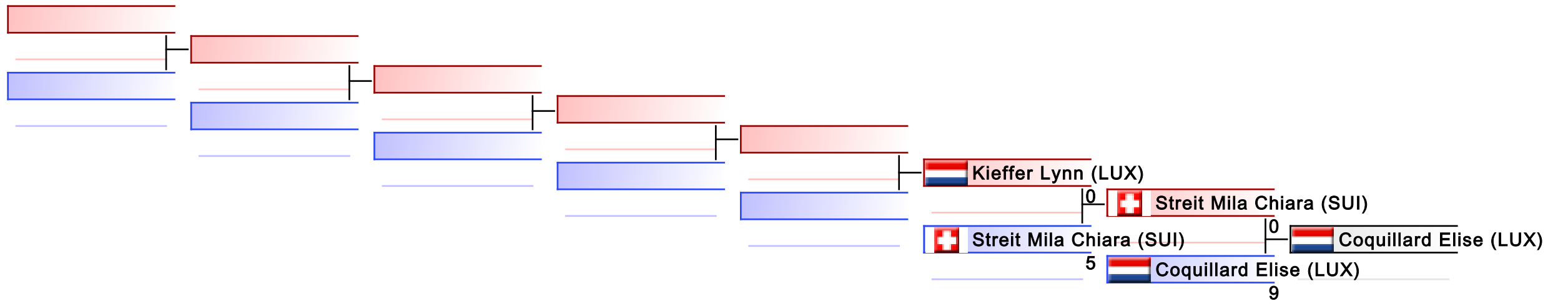

Lion Cup 2024 Luxembourg

297 Rue de Reckenthal L-2410 Strassen, LUXEMBOURG

Court Nr.	1	Pool	1	Date	2024-06-08	Field Position	35
RED				BLUE			
NOC	GERBER YARA (SUI)			NOC	MOONS CRUZ MAYLA (BEL)		
Category	Kumite Female U16 -47kg						
3 Points	2 Points	1 Point	Score	1 Point	2 Points	3 Points	
			2 : 0				
Penatlity					Penatlity		
C1: C1, C2:				2:0	C1: C1, C2:		
WINNER				Total			

Decision of Superiority

Judge 1	Judge 2	Judge 3	Judge 4	Judge 5	Judge 6	Judge 7	Referee

Name _____

Signature _____

Lion Cup 2024 Luxembourg

297 Rue de Reckenthal L-2410 Strassen, LUXEMBOURG

Court Nr.	1	Pool	1	Date	2024-06-08	Field Position	43	
RED				BLUE				
NOC	ANGELA RASKIN (BEL)			NOC	ZDEMIR DEMET (SUI)			
Category	Kumite Female U16 -47kg							
3 Points	2 Points	1 Point	Score	1 Point	2 Points	3 Points		
			0 : 9					
Penatlity				Penatlity				
C1: , C2:				0:9	C1: C1, C2:			
				Total	WINNER			

Decision of Superiority

Judge 1	Judge 2	Judge 3	Judge 4	Judge 5	Judge 6	Judge 7	Referee

Name _____

Signature _____

Lion Cup 2024 Luxembourg

297 Rue de Reckenthal L-2410 Strassen, LUXEMBOURG

Court Nr.	1	Pool	1	Date	2024-06-08	Field Position	49	
RED				BLUE				
NOC	VON KLASS MELISSA (SUI)			NOC	SELLAMI INSHIRAH (SUI)			
Category	Kumite Female U16 -47kg							
3 Points	2 Points	1 Point	Score	1 Point	2 Points	3 Points		
			0 : 2					
Penatlity				Penatlity				
C1: C2, C2:				0:2	C1: C2, C2:			
				Total	WINNER			

Decision of Superiority

Judge 1	Judge 2	Judge 3	Judge 4	Judge 5	Judge 6	Judge 7	Referee

Name _____

Signature _____

Lion Cup 2024 Luxembourg

297 Rue de Reckenthal L-2410 Strassen, LUXEMBOURG

Court Nr.	1	Pool	1	Date	2024-06-08	Field Position	50	
RED				BLUE				
NOC	GERBER YARA (SUI)			NOC	ACHGHOUYAB LYNA (NED)			
Category	Kumite Female U16 -47kg							
3 Points	2 Points	1 Point	Score	1 Point	2 Points	3 Points		
			1 : 5					
Penatlity				Penatlity				
C1: C1, C2:				1:5	C1: C3, C2:			
				Total	WINNER			

Decision of Superiority

Judge 1	Judge 2	Judge 3	Judge 4	Judge 5	Judge 6	Judge 7	Referee

Name _____

Signature _____

Lion Cup 2024 Luxembourg

297 Rue de Reckenthal L-2410 Strassen, LUXEMBOURG

Court Nr.	1	Pool	1	Date	2024-06-08	Field Position	51
RED				BLUE			
NOC	LEPEZ DARLA (NED)			NOC	PAYZINER SERENA (SUI)		
Category	Kumite Female U16 -47kg						
3 Points	2 Points	1 Point	Score	1 Point	2 Points	3 Points	
			1 : 1				
Penatlity				Penatlity			
C1: C2, C2:				1:1	C1: , C2:		
WINNER				Total			

Decision of Superiority

Judge 1	Judge 2	Judge 3	Judge 4	Judge 5	Judge 6	Judge 7	Referee

Name _____

Signature _____

Lion Cup 2024 Luxembourg

297 Rue de Reckenthal L-2410 Strassen, LUXEMBOURG

Court Nr.	1	Pool	1	Date	2024-06-08	Field Position	52
RED				BLUE			
NOC	FRISCHKNECHT JESSICA (SUI)			NOC	BERGER ALICIA (FRA)		
Category	Kumite Female U16 -47kg						
3 Points	2 Points	1 Point	Score	1 Point	2 Points	3 Points	
			0 : 4				
Penatlity				Penatlity			
C1: , C2:				0:4	C1: C1, C2:		
				Total	WINNER		

Decision of Superiority

Judge 1	Judge 2	Judge 3	Judge 4	Judge 5	Judge 6	Judge 7	Referee

Name _____

Signature _____

Lion Cup 2024 Luxembourg

297 Rue de Reckenthal L-2410 Strassen, LUXEMBOURG

Court Nr.	1	Pool	1	Date	2024-06-08	Field Position	53	
RED				BLUE				
NOC	SMIDTS GIULIA (BEL)			NOC	KOUME LEE-LOU (FRA)			
Category	Kumite Female U16 -47kg							
3 Points	2 Points	1 Point	Score	1 Point	2 Points	3 Points		
			0 : 5					
Penatlity				Penatlity				
C1: , C2:				0:5	C1: , C2:			
				Total	WINNER			

Decision of Superiority

Judge 1	Judge 2	Judge 3	Judge 4	Judge 5	Judge 6	Judge 7	Referee

Name _____

Signature _____

Lion Cup 2024 Luxembourg

297 Rue de Reckenthal L-2410 Strassen, LUXEMBOURG

Court Nr.	1	Pool	1	Date	2024-06-08	Field Position	54
RED				BLUE			
NOC	ZDEMIR DEMET (SUI)			NOC	COQUILLARD ELISE (LUX)		
Category	Kumite Female U16 -47kg						
3 Points	2 Points	1 Point	Score	1 Point	2 Points	3 Points	
			0 : 0				
Penatlity				Penatlity			
C1: C1, C2:			0:0	C1: C1, C2:			
			Total	WINNER			

Decision of Superiority

Judge 1	Judge 2	Judge 3	Judge 4	Judge 5	Judge 6	Judge 7	Referee

Name _____

Signature _____

Lion Cup 2024 Luxembourg

297 Rue de Reckenthal L-2410 Strassen, LUXEMBOURG

Court Nr.	1	Pool	1	Date	2024-06-08	Field Position	55	
RED				BLUE				
NOC	OYMAK ALMINA (SUI)			NOC	STREIT MILA CHIARA (SUI)			
Category	Kumite Female U16 -47kg							
3 Points	2 Points	1 Point	Score	1 Point	2 Points	3 Points		
			3 : 4					
Penatlity				Penatlity				
C1: , C2:				3:4	C1: , C2:			
				Total	WINNER			

Decision of Superiority

Judge 1	Judge 2	Judge 3	Judge 4	Judge 5	Judge 6	Judge 7	Referee

Name _____

Signature _____

Lion Cup 2024 Luxembourg

297 Rue de Reckenthal L-2410 Strassen, LUXEMBOURG

Court Nr.	1	Pool	1	Date	2024-06-08	Field Position	56	
RED				BLUE				
NOC	MEZRAUI DOUNIA SOFIA (NED)			NOC	KIEFFER LYNN (LUX)			
Category	Kumite Female U16 -47kg							
3 Points	2 Points	1 Point	Score	1 Point	2 Points	3 Points		
			7 : 0					
Penatlity				Penatlity				
C1: C3, C2:				7:0	C1: , C2:			
WINNER				Total				

Decision of Superiority

Judge 1	Judge 2	Judge 3	Judge 4	Judge 5	Judge 6	Judge 7	Referee

Name _____

Signature _____

Lion Cup 2024 Luxembourg

297 Rue de Reckenthal L-2410 Strassen, LUXEMBOURG

Court Nr.	1	Pool	1	Date	2024-06-08	Field Position	57
RED				BLUE			
NOC	SELLAMI INSHIRAH (SUI)			NOC	ACHGHOUYAB LYNA (NED)		
Category	Kumite Female U16 -47kg						
3 Points	2 Points	1 Point	Score	1 Point	2 Points	3 Points	
			0 : 3				
Penatlity				Penatlity			
C1: C1, C2:				0:3	C1: C2, C2:		
				Total	WINNER		

Decision of Superiority

Judge 1	Judge 2	Judge 3	Judge 4	Judge 5	Judge 6	Judge 7	Referee

Name _____

Signature _____

Lion Cup 2024 Luxembourg

297 Rue de Reckenthal L-2410 Strassen, LUXEMBOURG

Court Nr.	1	Pool	1	Date	2024-06-08	Field Position	58
RED				BLUE			
NOC	LEPEZ DARLA (NED)			NOC	BERGER ALICIA (FRA)		
Category	Kumite Female U16 -47kg						
3 Points	2 Points	1 Point	Score	1 Point	2 Points	3 Points	
			3 : 0				
Penatlity				Penatlity			
C1: , C2:				3:0	C1: C2, C2:		
WINNER				Total			

Decision of Superiority

Judge 1	Judge 2	Judge 3	Judge 4	Judge 5	Judge 6	Judge 7	Referee

Name _____

Signature _____

Lion Cup 2024 Luxembourg

297 Rue de Reckenthal L-2410 Strassen, LUXEMBOURG

Court Nr.	1	Pool	1	Date	2024-06-08	Field Position	59	
RED				BLUE				
NOC	KOUME LEE-LOU (FRA)			NOC	COQUILLARD ELISE (LUX)			
Category	Kumite Female U16 -47kg							
3 Points	2 Points	1 Point	Score	1 Point	2 Points	3 Points		
			0 : 1					
Penatlity				Penatlity				
C1: C1, C2:				0:1	C1: C2, C2:			
				Total	WINNER			

Decision of Superiority

Judge 1	Judge 2	Judge 3	Judge 4	Judge 5	Judge 6	Judge 7	Referee

Name _____

Signature _____

Lion Cup 2024 Luxembourg

297 Rue de Reckenthal L-2410 Strassen, LUXEMBOURG

Court Nr.	1	Pool	1	Date	2024-06-08	Field Position	60
RED				BLUE			
NOC	STREIT MILA CHIARA (SUI)			NOC	MEZRAUI DOUNIA SOFIA (NED)		
Category	Kumite Female U16 -47kg						
3 Points	2 Points	1 Point	Score	1 Point	2 Points	3 Points	
			0 : 2				
Penatlity				Penatlity			
C1: C2, C2:				0:2	C1: , C2:		
				Total	WINNER		

Decision of Superiority

Judge 1	Judge 2	Judge 3	Judge 4	Judge 5	Judge 6	Judge 7	Referee

Name _____

Signature _____

Lion Cup 2024 Luxembourg

297 Rue de Reckenthal L-2410 Strassen, LUXEMBOURG

Court Nr.	1	Pool	1	Date	2024-06-08	Field Position	61
RED				BLUE			
NOC	ACHGHOUYAB LYNA (NED)			NOC	LEPEZ DARLA (NED)		
Category	Kumite Female U16 -47kg						
3 Points	2 Points	1 Point	Score	1 Point	2 Points	3 Points	
			4 : 2				
Penatlity				Penatlity			
C1: HC, C2:				4:2	C1: , C2:		
WINNER				Total			

Decision of Superiority

Judge 1	Judge 2	Judge 3	Judge 4	Judge 5	Judge 6	Judge 7	Referee

Name _____

Signature _____

Lion Cup 2024 Luxembourg

297 Rue de Reckenthal L-2410 Strassen, LUXEMBOURG

Court Nr.	1	Pool	1	Date	2024-06-08	Field Position	62
RED				BLUE			
NOC	COQUILLARD ELISE (LUX)			NOC	MEZRAUI DOUNIA SOFIA (NED)		
Category	Kumite Female U16 -47kg						
3 Points	2 Points	1 Point	Score	1 Point	2 Points	3 Points	
			0 : 0				
Penatlity				Penatlity			
C1: C1, C2:				0:0	C1: C3, C2:		
				Total	WINNER		

Decision of Superiority

Judge 1	Judge 2	Judge 3	Judge 4	Judge 5	Judge 6	Judge 7	Referee

Name _____

Signature _____

Lion Cup 2024 Luxembourg

297 Rue de Reckenthal L-2410 Strassen, LUXEMBOURG

Court Nr.	1	Pool	1	Date	2024-06-08	Field Position	63	
RED				BLUE				
NOC	ACHGHOUYAB LYNA (NED)			NOC	MEZRAUI DOUNIA SOFIA (NED)			
Category	Kumite Female U16 -47kg							
3 Points	2 Points	1 Point	Score	1 Point	2 Points	3 Points		
			0 : 0					
Penatlity				Penatlity				
C1: , C2:				0:0	C1: , C2:			
				Total	WINNER			

Decision of Superiority

Judge 1	Judge 2	Judge 3	Judge 4	Judge 5	Judge 6	Judge 7	Referee

Name _____

Signature _____

Lion Cup 2024 Luxembourg

297 Rue de Reckenthal L-2410 Strassen, LUXEMBOURG

Court Nr.	1	Pool	1	Date	2024-06-08	Field Position	0
RED				BLUE			
NOC	GERBER YARA (SUI)			NOC	LEPEZ DARLA (NED)		
Category	Kumite Female U16 -47kg						
3 Points	2 Points	1 Point	Score	1 Point	2 Points	3 Points	
			1 : 2				
Penatlity				Penatlity			
C1: , C2:			1:2	C1: , C2:			
			Total	WINNER			

Decision of Superiority

Judge 1	Judge 2	Judge 3	Judge 4	Judge 5	Judge 6	Judge 7	Referee

Name _____

Signature _____

Lion Cup 2024 Luxembourg

297 Rue de Reckenthal L-2410 Strassen, LUXEMBOURG

Court Nr.	1	Pool	1	Date	2024-06-08	Field Position	2
RED				BLUE			
NOC	GERBER YARA (SUI)			NOC	SELLAMI INSHIRAH (SUI)		
Category	Kumite Female U16 -47kg						
3 Points	2 Points	1 Point	Score	1 Point	2 Points	3 Points	
			:				
Penatlity				Penatlity			
			Total				

Decision of Superiority

Judge 1	Judge 2	Judge 3	Judge 4	Judge 5	Judge 6	Judge 7	Referee

Name _____

Signature _____

Lion Cup 2024 Luxembourg

297 Rue de Reckenthal L-2410 Strassen, LUXEMBOURG

Court Nr.	2	Pool	2	Date	2024-06-08	Field Position	0
RED				BLUE			
NOC	STREIT MILA CHIARA (SUI)			NOC	COQUILLARD ELISE (LUX)		
Category	Kumite Female U16 -47kg						
3 Points	2 Points	1 Point	Score	1 Point	2 Points	3 Points	
			0 : 9				
Penatlity				Penatlity			
C1: C1, C2:				0:9	C1: , C2:		
				Total	WINNER		

Decision of Superiority

Judge 1	Judge 2	Judge 3	Judge 4	Judge 5	Judge 6	Judge 7	Referee

Name _____

Signature _____

Lion Cup 2024 Luxembourg

297 Rue de Reckenthal L-2410 Strassen, LUXEMBOURG

Court Nr.	2	Pool	2	Date	2024-06-08	Field Position	2
RED				BLUE			
NOC	KIEFFER LYNN (LUX)			NOC	STREIT MILA CHIARA (SUI)		
Category	Kumite Female U16 -47kg						
3 Points	2 Points	1 Point	Score	1 Point	2 Points	3 Points	
			0 : 5				
Penatlity				Penatlity			
C1: C1, C2:			0:5	C1: C2, C2:			
			Total	WINNER			

Decision of Superiority

Judge 1	Judge 2	Judge 3	Judge 4	Judge 5	Judge 6	Judge 7	Referee

Name _____

Signature _____

Official Results

Kumite Female U16 -47kg			
1	MEZRAUI DOUNIA SOFIA		NED - NETHERLANDS
2	ACHGHOUYAB LYNA		NED - NETHERLANDS
3	LEPEZ DARLA		NED - NETHERLANDS
3	COQUILLARD ELISE		LUX - LUXEMBOURG
5	GERBER YARA		SUI - SWITZERLAND
5	STREIT MILA CHIARA		SUI - SWITZERLAND
7	SELLAMI INSHIRAH		SUI - SWITZERLAND
7	KIEFFER LYNN		LUX - LUXEMBOURG

KUMITE FEMALE U16 -54KG

Lion Cup 2024 Luxembourg

ENTRIES BY WEIGHT CATEGORY
Kumite Female U16 -54kg

As of 8 JUN 2024

NOC Code	Gender	Name	Seeding
ALG	F	AMMOUR IMENE	
BEL	F	EL LAHIOUI Aya	
BEL	F	PATRUNSU DENISA	
BEL	F	TARCHI Sabrina	
LUX	F	LEGALL Romane	
LUX	F	Muller Eva	
LUX	F	Terlica Gomes Océane	
LUX	F	Theisen Margot	
NED	F	Bensalaf Israe	
NED	F	Koop Quinty	
NED	F	Limes lois	
NED	F	Unruh Eline	
NOR	F	Johansen Madeleine	
POL	F	Yakubovska Valeriia	
SUI	F	Dumitras Pia	
SUI	F	Fleischmann Alany Alexa	
SUI	F	Gaus Anja	
SUI	F	Pulver Melina	
SUI	F	Sanneh Fatumata	
SUI	F	Tscharner Anais	
SWE	F	Ghinia Sofia	

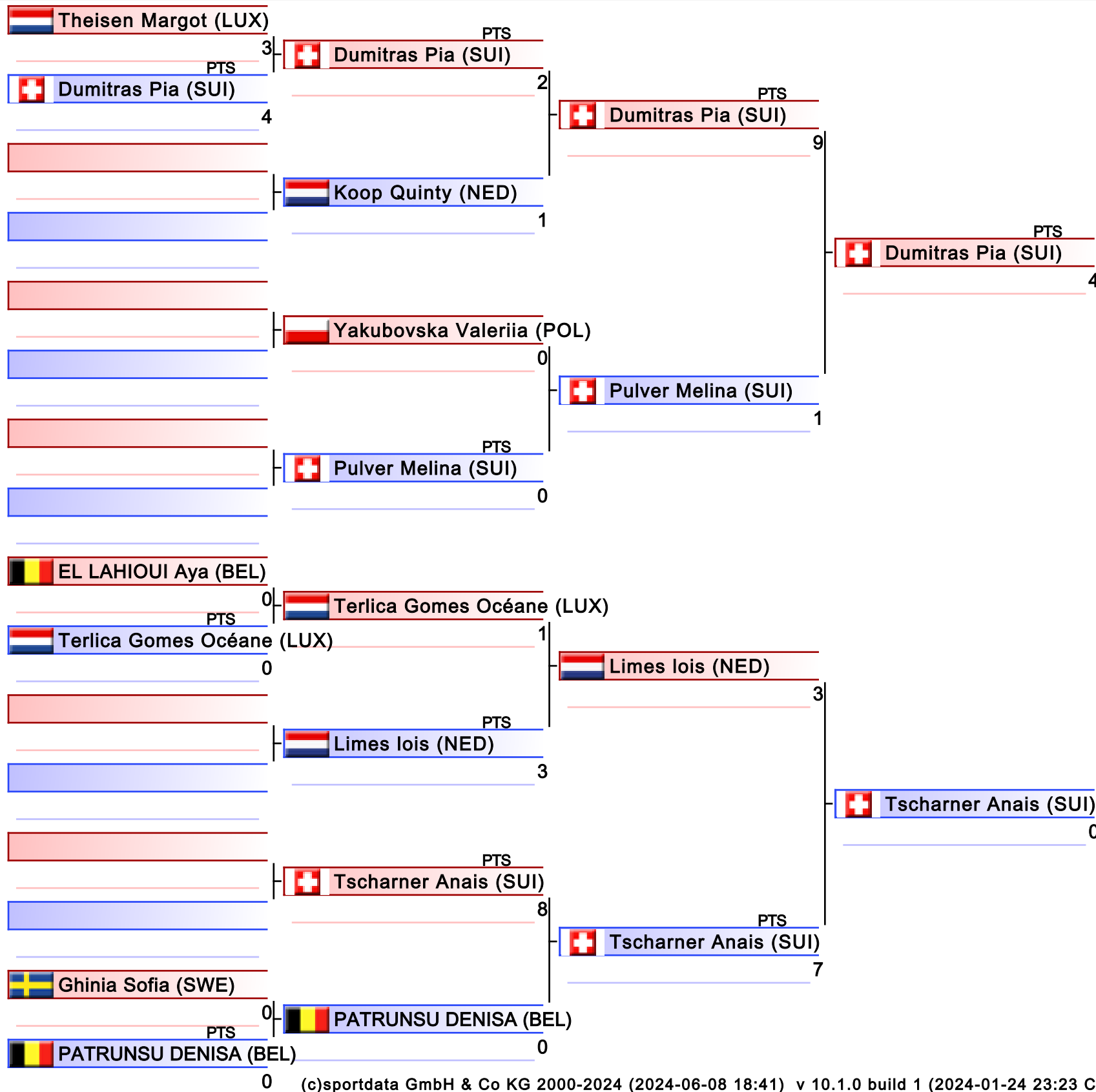



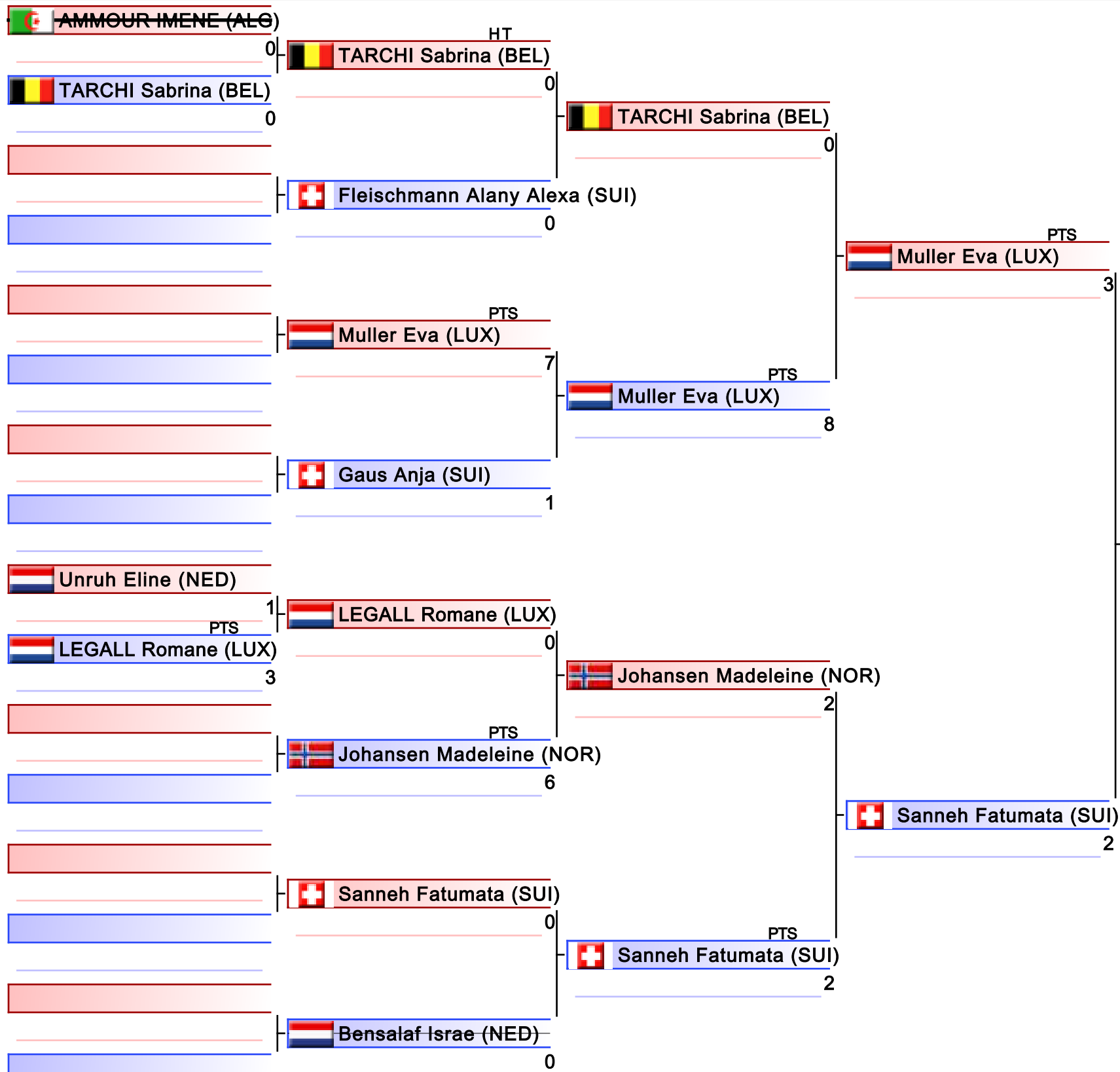

Dumitras Pia (SUI)

1. DUMITRAS PIA (SUI)
2. MULLER EVA (LUX)
3. SANNEH FATUMATA (SUI)
3. TSCHARNER ANAIS (SUI)
5. GAUS ANJA (SUI)
5. PULVER MELINA (SUI)
7. TARCHI SABRINA (BEL)
7. KOOP QUINTY (NED)

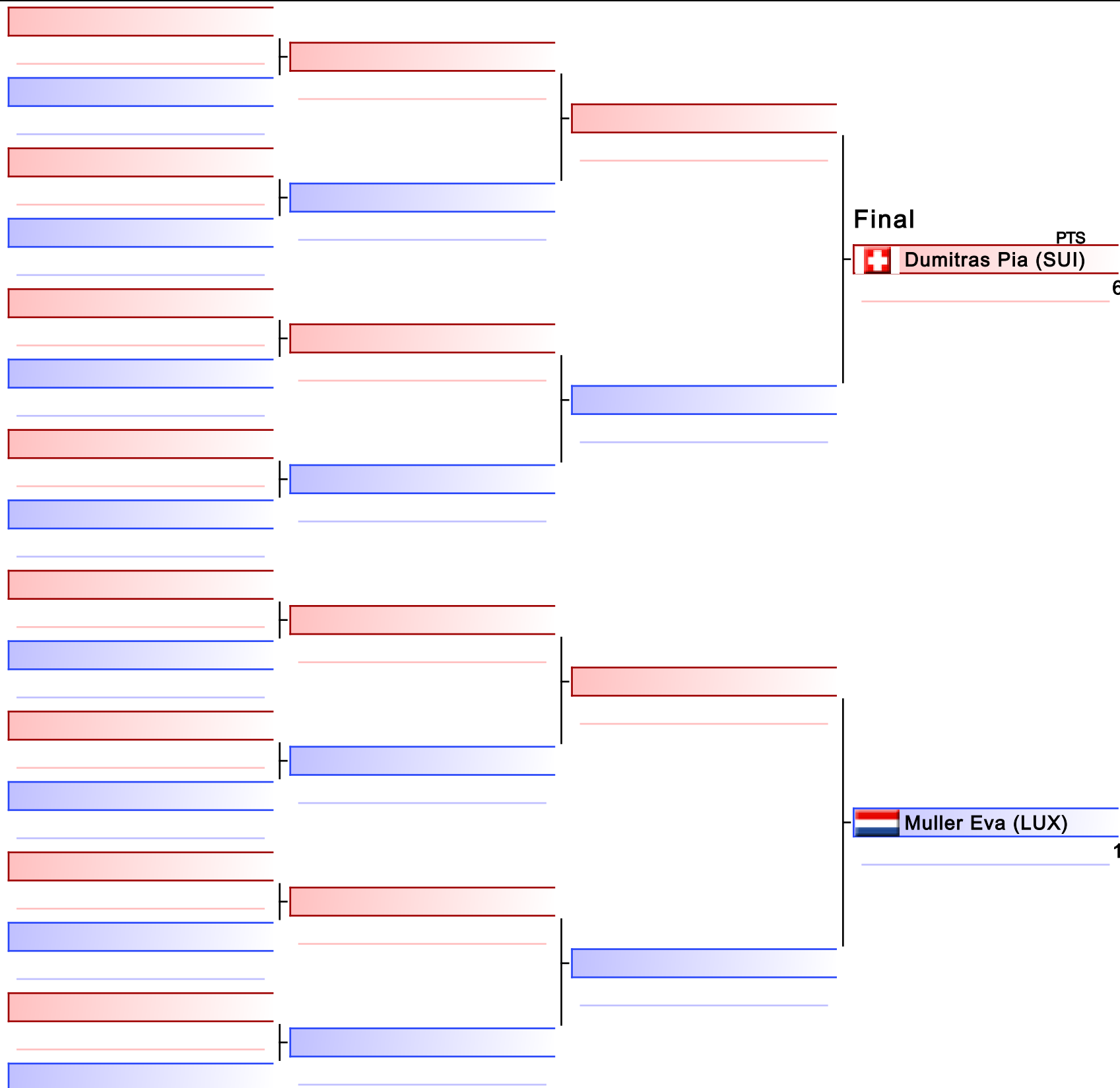

1. DUMITRAS PIA (SUI)
2. MULLER EVA (LUX)
3. SANNEH FATUMATA (SUI)
3. TSCHARNER ANAIS (SUI)
5. GAUS ANJA (SUI)
5. PULVER MELINA (SUI)
7. TARCHI SABRINA (BEL)
7. KOOP QUINTY (NED)



Final	
	PTS
 Dumitras Pia (SUI)	6
 Dumitras Pia (SUI)	
 Muller Eva (LUX)	1

1. DUMITRAS PIA (SUI)
2. MULLER EVA (LUX)
3. SANNEH FATUMATA (SUI)
3. TSCHARNER ANAIS (SUI)
5. GAUS ANJA (SUI)
5. PULVER MELINA (SUI)
7. TARCHI SABRINA (BEL)
7. KOOP QUINTY (NED)

Kumite Female U16 -54kg

Lion Cup 2024 Luxembourg

2024-06-08

Tatami
1 17:30

Pool
1

(c)sportdata GmbH & Co KG 2000-2024 (2024-06-08 18:41) v 10.1.0 build 1 (2024-01-24 23:23 CET) License: Online_Event_ID-7672_LionCup2024Luxembourg (expire 2024-06-21)

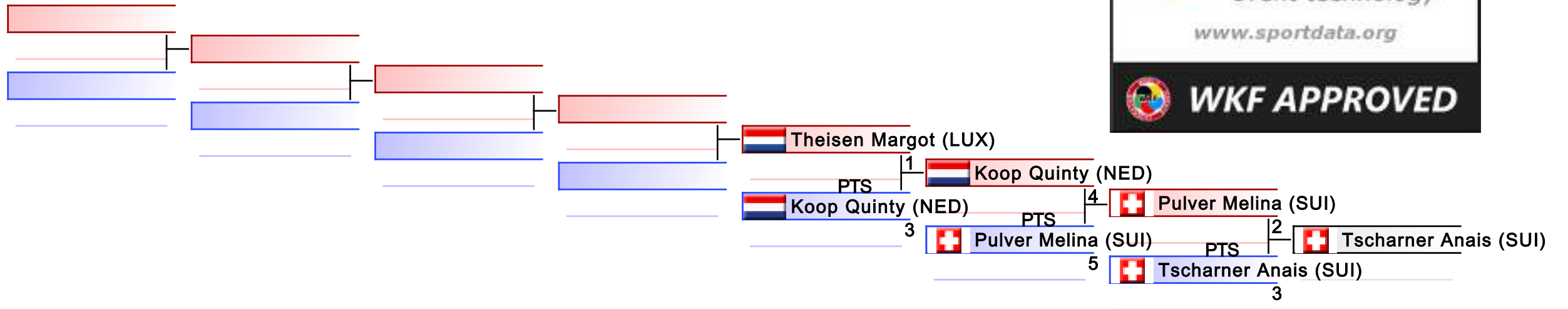

REPECHAGE: (1)

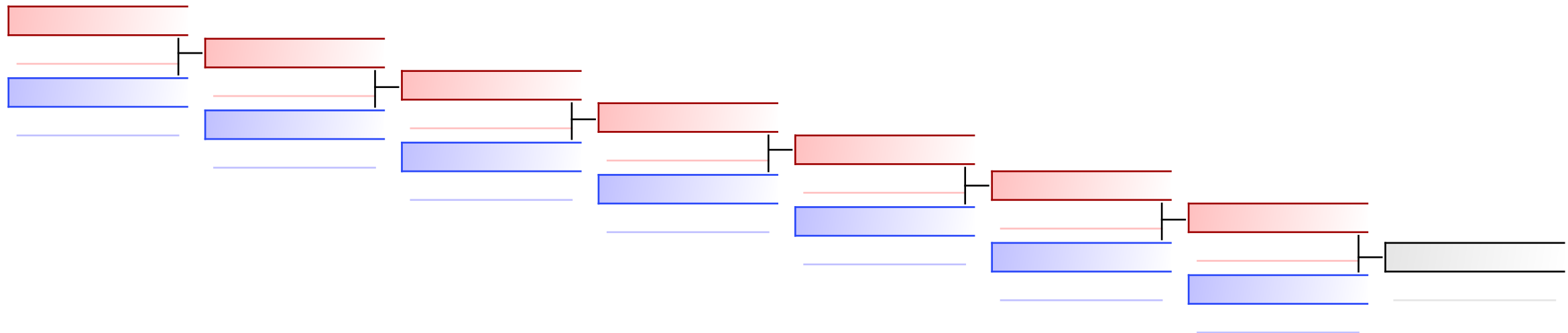

Kumite Female U16 -54kg

Lion Cup 2024 Luxembourg

2024-06-08

Tatami
2 17:25

Pool
2

(c)sportdata GmbH & Co KG 2000-2024 (2024-06-08 18:41) v 10.1.0 build 1 (2024-01-24 23:23 CET) License: Online_Event_ID-7672_LionCup2024Luxembourg (expire 2024-06-21)

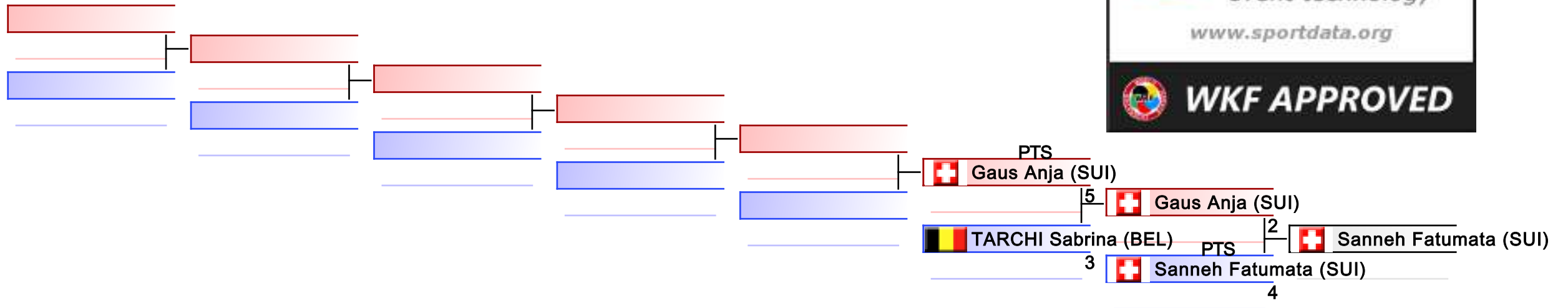

REPECHAGE: (2)

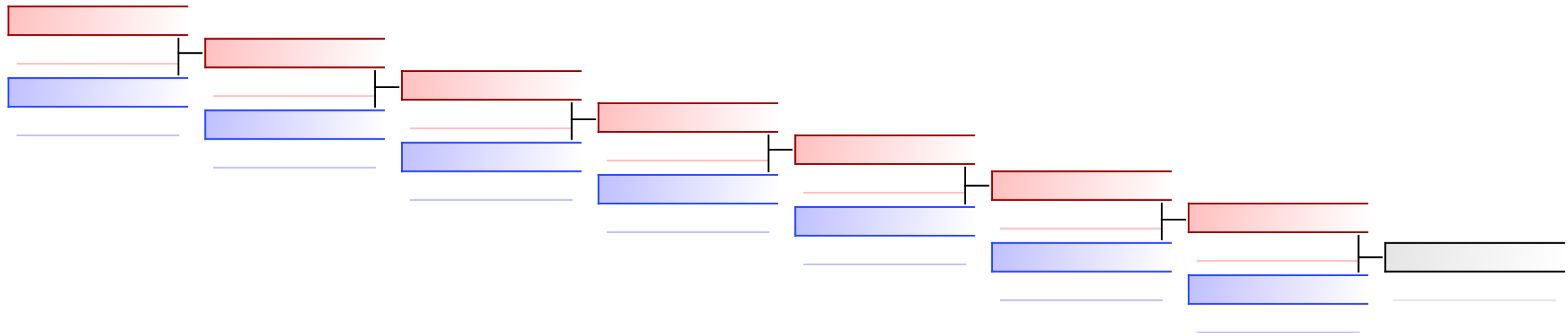

Lion Cup 2024 Luxembourg

297 Rue de Reckenthal L-2410 Strassen, LUXEMBOURG

Court Nr.	1	Pool	1	Date	2024-06-08	Field Position	49
RED				BLUE			
NOC	THEISEN MARGOT (LUX)			NOC	DUMITRAS PIA (SUI)		
Category	Kumite Female U16 -54kg						
3 Points	2 Points	1 Point	Score	1 Point	2 Points	3 Points	
			3 : 4				
Penatlity				Penatlity			
C1: , C2:				3:4	C1: C2, C2:		
				Total	WINNER		

PTS

Decision of Superiority

Judge 1	Judge 2	Judge 3	Judge 4	Judge 5	Judge 6	Judge 7	Referee

Name _____

Signature _____

Lion Cup 2024 Luxembourg

297 Rue de Reckenthal L-2410 Strassen, LUXEMBOURG

Court Nr.	1	Pool	1	Date	2024-06-08	Field Position	53
RED				BLUE			
NOC	EL LAHIOUI AYA (BEL)			NOC	TERLICA GOMES OCANE (LUX)		
Category	Kumite Female U16 -54kg						
3 Points	2 Points	1 Point	Score	1 Point	2 Points	3 Points	
			0 : 0				
Penatlity				Penatlity			
C1: , C2:				0:0	C1: , C2:		
				Total	WINNER		

PTS

Decision of Superiority

Judge 1	Judge 2	Judge 3	Judge 4	Judge 5	Judge 6	Judge 7	Referee

Name _____

Signature _____

Lion Cup 2024 Luxembourg

297 Rue de Reckenthal L-2410 Strassen, LUXEMBOURG

Court Nr.	1	Pool	1	Date	2024-06-08	Field Position	56
RED				BLUE			
NOC	GHINIA SOFIA (SWE)			NOC	PATRUNSU DENISA (BEL)		
Category	Kumite Female U16 -54kg						
3 Points	2 Points	1 Point	Score	1 Point	2 Points	3 Points	
			0 : 0				
Penatlity				Penatlity			
C1: , C2:				0:0	C1: , C2:		
				Total	WINNER		

PTS

Decision of Superiority

Judge 1	Judge 2	Judge 3	Judge 4	Judge 5	Judge 6	Judge 7	Referee

Name _____

Signature _____

Lion Cup 2024 Luxembourg

297 Rue de Reckenthal L-2410 Strassen, LUXEMBOURG

Court Nr.	1	Pool	1	Date	2024-06-08	Field Position	57	
RED				BLUE				
NOC	DUMITRAS PIA (SUI)			NOC	KOOP QUINTY (NED)			
Category	Kumite Female U16 -54kg							
3 Points	2 Points	1 Point	Score	1 Point	2 Points	3 Points		
			2 : 1					
Penatlity				Penatlity				
C1: , C2:				2:1	C1: , C2:			
WINNER				Total				

PTS

Decision of Superiority

Judge 1	Judge 2	Judge 3	Judge 4	Judge 5	Judge 6	Judge 7	Referee

Name _____

Signature _____

Lion Cup 2024 Luxembourg

297 Rue de Reckenthal L-2410 Strassen, LUXEMBOURG

Court Nr.	1	Pool	1	Date	2024-06-08	Field Position	58
RED				BLUE			
NOC	YAKUBOVSKA VALERIIA (POL)			NOC	PULVER MELINA (SUI)		
Category	Kumite Female U16 -54kg						
3 Points	2 Points	1 Point	Score	1 Point	2 Points	3 Points	
			0 : 0				
Penatlity				Penatlity			
C1: , C2:				0:0	C1: , C2:		
				Total	WINNER		

PTS

Decision of Superiority

Judge 1	Judge 2	Judge 3	Judge 4	Judge 5	Judge 6	Judge 7	Referee

Name _____

Signature _____

Lion Cup 2024 Luxembourg

297 Rue de Reckenthal L-2410 Strassen, LUXEMBOURG

Court Nr.	1	Pool	1	Date	2024-06-08	Field Position	59
RED				BLUE			
NOC	TERLICA GOMES OCANE (LUX)			NOC	LIMES LOIS (NED)		
Category	Kumite Female U16 -54kg						
3 Points	2 Points	1 Point	Score	1 Point	2 Points	3 Points	
			1 : 3				
Penatlity				Penatlity			
C1: , C2:				1:3	C1: C1, C2:		
				Total	WINNER		

PTS

Decision of Superiority

Judge 1	Judge 2	Judge 3	Judge 4	Judge 5	Judge 6	Judge 7	Referee

Name _____

Signature _____

Lion Cup 2024 Luxembourg

297 Rue de Reckenthal L-2410 Strassen, LUXEMBOURG

Court Nr.	1	Pool	1	Date	2024-06-08	Field Position	60	
RED				BLUE				
NOC	TSCHARNER ANAIS (SUI)			NOC	PATRUNSU DENISA (BEL)			
Category	Kumite Female U16 -54kg							
3 Points	2 Points	1 Point	Score	1 Point	2 Points	3 Points		
			8 : 0					
Penatlity				Penatlity				
C1: , C2:				8:0	C1: C1, C2:			
WINNER				Total				

PTS

Decision of Superiority

Judge 1	Judge 2	Judge 3	Judge 4	Judge 5	Judge 6	Judge 7	Referee

Name _____

Signature _____

Lion Cup 2024 Luxembourg

297 Rue de Reckenthal L-2410 Strassen, LUXEMBOURG

Court Nr.	1	Pool	1	Date	2024-06-08	Field Position	61	
RED				BLUE				
NOC	DUMITRAS PIA (SUI)			NOC	PULVER MELINA (SUI)			
Category	Kumite Female U16 -54kg							
3 Points	2 Points	1 Point	Score	1 Point	2 Points	3 Points		
			9 : 1					
Penatlity				Penatlity				
C1: , C2:				9:1	C1: C1, C2:			
WINNER				Total				

PTS

Decision of Superiority

Judge 1	Judge 2	Judge 3	Judge 4	Judge 5	Judge 6	Judge 7	Referee

Name _____

Signature _____

Lion Cup 2024 Luxembourg

297 Rue de Reckenthal L-2410 Strassen, LUXEMBOURG

Court Nr.	1	Pool	1	Date	2024-06-08	Field Position	62	
RED				BLUE				
NOC	LIMES LOIS (NED)			NOC	TSCHARNER ANAIS (SUI)			
Category	Kumite Female U16 -54kg							
3 Points	2 Points	1 Point	Score	1 Point	2 Points	3 Points		
			3 : 7					
Penatlity				Penatlity				
C1: , C2:				3:7	C1: C1, C2:			
				Total	WINNER			

PTS

Decision of Superiority

Judge 1	Judge 2	Judge 3	Judge 4	Judge 5	Judge 6	Judge 7	Referee

Name _____

Signature _____

Lion Cup 2024 Luxembourg

297 Rue de Reckenthal L-2410 Strassen, LUXEMBOURG

Court Nr.	1	Pool	1	Date	2024-06-08	Field Position	63	
RED				BLUE				
NOC	DUMITRAS PIA (SUI)			NOC	TSCHARNER ANAIS (SUI)			
Category	Kumite Female U16 -54kg							
3 Points	2 Points	1 Point	Score	1 Point	2 Points	3 Points		
			4 : 0					
Penatlity				Penatlity				
C1: HC, C2:				4:0	C1: C1, C2:			
WINNER				Total				

PTS

Decision of Superiority

Judge 1	Judge 2	Judge 3	Judge 4	Judge 5	Judge 6	Judge 7	Referee

Name _____

Signature _____

Lion Cup 2024 Luxembourg

297 Rue de Reckenthal L-2410 Strassen, LUXEMBOURG

Court Nr.	2	Pool	2	Date	2024-06-08	Field Position	53	
RED				BLUE				
NOC	UNRUH ELINE (NED)			NOC	LEGALL ROMANE (LUX)			
Category	Kumite Female U16 -54kg							
3 Points	2 Points	1 Point	Score	1 Point	2 Points	3 Points		
			1 : 3					
Penatlity				Penatlity				
C1: C1, C2:				1:3	C1: C1, C2:			
				Total	WINNER			

PTS

Decision of Superiority

Judge 1	Judge 2	Judge 3	Judge 4	Judge 5	Judge 6	Judge 7	Referee

Name _____

Signature _____

Lion Cup 2024 Luxembourg

297 Rue de Reckenthal L-2410 Strassen, LUXEMBOURG

Court Nr.	2	Pool	2	Date	2024-06-08	Field Position	57
RED				BLUE			
NOC	TARCHI SABRINA (BEL)			NOC	FLEISCHMANN ALANY ALEXA (SUI)		
Category	Kumite Female U16 -54kg						
3 Points	2 Points	1 Point	Score	1 Point	2 Points	3 Points	
			0 : 0				
Penatlity				Penatlity			
C1: C1, C2:				0:0	C1: , C2:		
WINNER				Total			

HT

Decision of Superiority

Judge 1	Judge 2	Judge 3	Judge 4	Judge 5	Judge 6	Judge 7	Referee

Name _____

Signature _____

Lion Cup 2024 Luxembourg

297 Rue de Reckenthal L-2410 Strassen, LUXEMBOURG

Court Nr.	2	Pool	2	Date	2024-06-08	Field Position	58
RED				BLUE			
NOC	MULLER EVA (LUX)			NOC	GAUS ANJA (SUI)		
Category	Kumite Female U16 -54kg						
3 Points	2 Points	1 Point	Score	1 Point	2 Points	3 Points	
			7 : 1				
Penatlity				Penatlity			
C1: , C2:				7:1	C1: , C2:		
WINNER				Total			

PTS

Decision of Superiority

Judge 1	Judge 2	Judge 3	Judge 4	Judge 5	Judge 6	Judge 7	Referee

Name _____

Signature _____

Lion Cup 2024 Luxembourg

297 Rue de Reckenthal L-2410 Strassen, LUXEMBOURG

Court Nr.	2	Pool	2	Date	2024-06-08	Field Position	59
RED				BLUE			
NOC	LEGALL ROMANE (LUX)			NOC	JOHANSEN MADELEINE (NOR)		
Category	Kumite Female U16 -54kg						
3 Points	2 Points	1 Point	Score	1 Point	2 Points	3 Points	
			0 : 6				
Penatlity				Penatlity			
C1: C1, C2:				0:6	C1: , C2:		
				Total	WINNER		

PTS

Decision of Superiority

Judge 1	Judge 2	Judge 3	Judge 4	Judge 5	Judge 6	Judge 7	Referee

Name _____

Signature _____

Lion Cup 2024 Luxembourg

297 Rue de Reckenthal L-2410 Strassen, LUXEMBOURG

Court Nr.	2	Pool	2	Date	2024-06-08	Field Position	61
RED				BLUE			
NOC	TARCHI SABRINA (BEL)			NOC	MULLER EVA (LUX)		
Category	Kumite Female U16 -54kg						
3 Points	2 Points	1 Point	Score	1 Point	2 Points	3 Points	
			0 : 8				
Penatlity				Penatlity			
C1: C1, C2:			0:8	C1: , C2:			
			Total	WINNER			

PTS

Decision of Superiority

Judge 1	Judge 2	Judge 3	Judge 4	Judge 5	Judge 6	Judge 7	Referee

Name _____

Signature _____

Lion Cup 2024 Luxembourg

297 Rue de Reckenthal L-2410 Strassen, LUXEMBOURG

Court Nr.	2	Pool	2	Date	2024-06-08	Field Position	62	
RED				BLUE				
NOC	JOHANSEN MADELEINE (NOR)			NOC	SANNEH FATUMATA (SUI)			
Category	Kumite Female U16 -54kg							
3 Points	2 Points	1 Point	Score	1 Point	2 Points	3 Points		
			2 : 2					
Penatlity				Penatlity				
C1: , C2:				2:2	C1: , C2:			
				Total	WINNER			

PTS

Decision of Superiority

Judge 1	Judge 2	Judge 3	Judge 4	Judge 5	Judge 6	Judge 7	Referee

Name _____

Signature _____

Lion Cup 2024 Luxembourg

297 Rue de Reckenthal L-2410 Strassen, LUXEMBOURG

Court Nr.	2	Pool	2	Date	2024-06-08	Field Position	63
RED				BLUE			
NOC	MULLER EVA (LUX)			NOC	SANNEH FATUMATA (SUI)		
Category	Kumite Female U16 -54kg						
3 Points	2 Points	1 Point	Score	1 Point	2 Points	3 Points	
			3 : 2				
Penatlity				Penatlity			
C1: , C2:				3:2	C1: C1, C2:		
WINNER				Total			

PTS

Decision of Superiority

Judge 1	Judge 2	Judge 3	Judge 4	Judge 5	Judge 6	Judge 7	Referee

Name _____

Signature _____

Lion Cup 2024 Luxembourg

297 Rue de Reckenthal L-2410 Strassen, LUXEMBOURG

Court Nr.	1	Pool	1	Date	2024-06-08	Field Position	63	
RED				BLUE				
NOC	DUMITRAS PIA (SUI)			NOC	MULLER EVA (LUX)			
Category	Kumite Female U16 -54kg							
3 Points	2 Points	1 Point	Score	1 Point	2 Points	3 Points		
			6 : 1					
Penatlity				Penatlity				
C1: C1, C2:				6:1	C1: , C2:			
WINNER				Total				

PTS

Decision of Superiority

Judge 1	Judge 2	Judge 3	Judge 4	Judge 5	Judge 6	Judge 7	Referee

Name _____

Signature _____

Lion Cup 2024 Luxembourg

297 Rue de Reckenthal L-2410 Strassen, LUXEMBOURG

Court Nr.	1	Pool	1	Date	2024-06-08	Field Position	0	
RED				BLUE				
NOC	PULVER MELINA (SUI)			NOC	TSCHARNER ANAIS (SUI)			
Category	Kumite Female U16 -54kg							
3 Points	2 Points	1 Point	Score	1 Point	2 Points	3 Points		
			2 : 3					
Penatlity				Penatlity				
C1: C1, C2:				2:3	C1: C2, C2:			
				Total	WINNER			

PTS

Decision of Superiority

Judge 1	Judge 2	Judge 3	Judge 4	Judge 5	Judge 6	Judge 7	Referee

Name _____

Signature _____

Lion Cup 2024 Luxembourg

297 Rue de Reckenthal L-2410 Strassen, LUXEMBOURG

Court Nr.	1	Pool	1	Date	2024-06-08	Field Position	2
RED				BLUE			
NOC	KOOP QUINTY (NED)			NOC	PULVER MELINA (SUI)		
Category	Kumite Female U16 -54kg						
3 Points	2 Points	1 Point	Score	1 Point	2 Points	3 Points	
			4 : 5				
Penatlity				Penatlity			
C1: C1, C2:			4:5	C1: C1, C2:			
			Total	WINNER			

PTS

Decision of Superiority

Judge 1	Judge 2	Judge 3	Judge 4	Judge 5	Judge 6	Judge 7	Referee

Name _____

Signature _____

Lion Cup 2024 Luxembourg

297 Rue de Reckenthal L-2410 Strassen, LUXEMBOURG

Court Nr.	1	Pool	1	Date	2024-06-08	Field Position	4
RED				BLUE			
NOC	THEISEN MARGOT (LUX)			NOC	KOOP QUINTY (NED)		
Category	Kumite Female U16 -54kg						
3 Points	2 Points	1 Point	Score	1 Point	2 Points	3 Points	
			:				
Penatlity				Penatlity			
			Total				

Decision of Superiority

Judge 1	Judge 2	Judge 3	Judge 4	Judge 5	Judge 6	Judge 7	Referee

Name _____

Signature _____

Official Results

Kumite Female U16 -54kg			
1	DUMITRAS PIA		SUI - SWITZERLAND
2	MULLER EVA		LUX - LUXEMBOURG
3	SANNEH FATUMATA		SUI - SWITZERLAND
3	TSCHARNER ANAIS		SUI - SWITZERLAND
5	GAUS ANJA		SUI - SWITZERLAND
5	PULVER MELINA		SUI - SWITZERLAND
7	TARCHI SABRINA		BEL - BELGIUM
7	KOOP QUINTY		NED - NETHERLANDS
9	THEISEN MARGOT		LUX - LUXEMBOURG

KUMITE FEMALE U16 +61KG

Lion Cup 2024 Luxembourg

ENTRIES BY WEIGHT CATEGORY
Kumite Female U16 +61KG

As of 8 JUN 2024

NOC Code	Gender	Name	Seeding
BEL	F	Sridi Maissa	
BEL	F	Vanrooy Chiara	
FRA	F	Homri Tesnime	
LUX	F	Couturier Louise	
LUX	F	Olafsson Elena	
NED	F	Bohoudi Nada	
NED	F	Veer Fiane	
SUI	F	Alari Susan	
SUI	F	Erol Beril	
SUI	F	Redzic Esma	

Kumite Female U16 +61KG

Lion Cup 2024 Luxembourg, 297 Rue de Reckenthal L-2410 Strassen, LUX

2024-06-08

Tatami
6 14:40

Pool
1 / 1

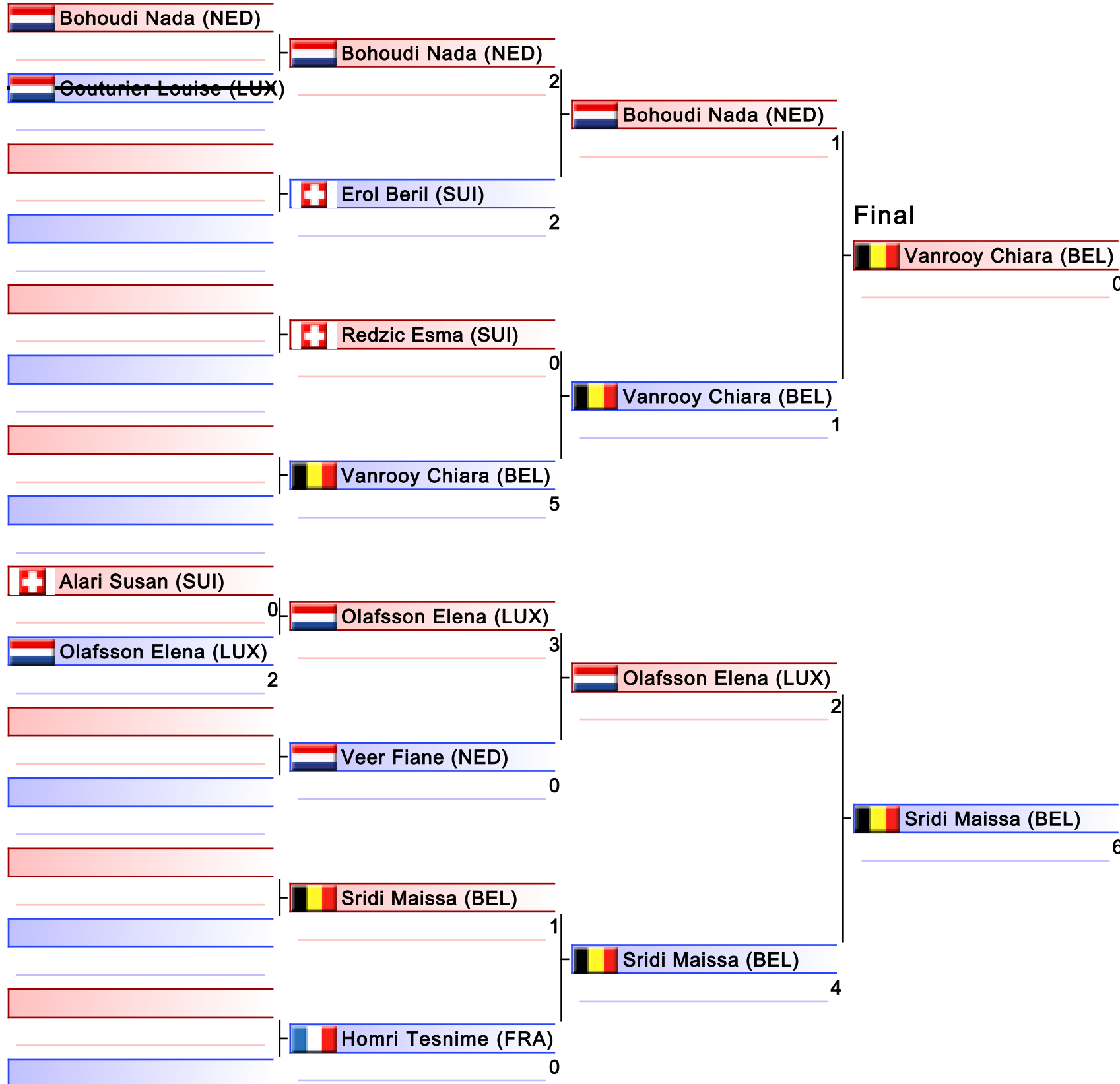

1. SRIDI MAISSA (BEL)
2. VANROOY CHIARA (BEL)
3. REDZIC ESMA (SUI)
3. HOMRI TESNIME (FRA)
5. BOHOUDI NADA (NED)
5. OLAFSSON ELENA (LUX)

Kumite Female U16 +61KG

Lion Cup 2024 Luxembourg

2024-06-08

Tatami
6 15:20

Pool
1

(c)sportdata GmbH & Co KG 2000-2024 (2024-06-08 18:41) v 10.1.0 build 1 (2024-01-24 23:23 CET) License: Online_Event_ID-7672_LionCup2024Luxembourg (expire 2024-06-21)

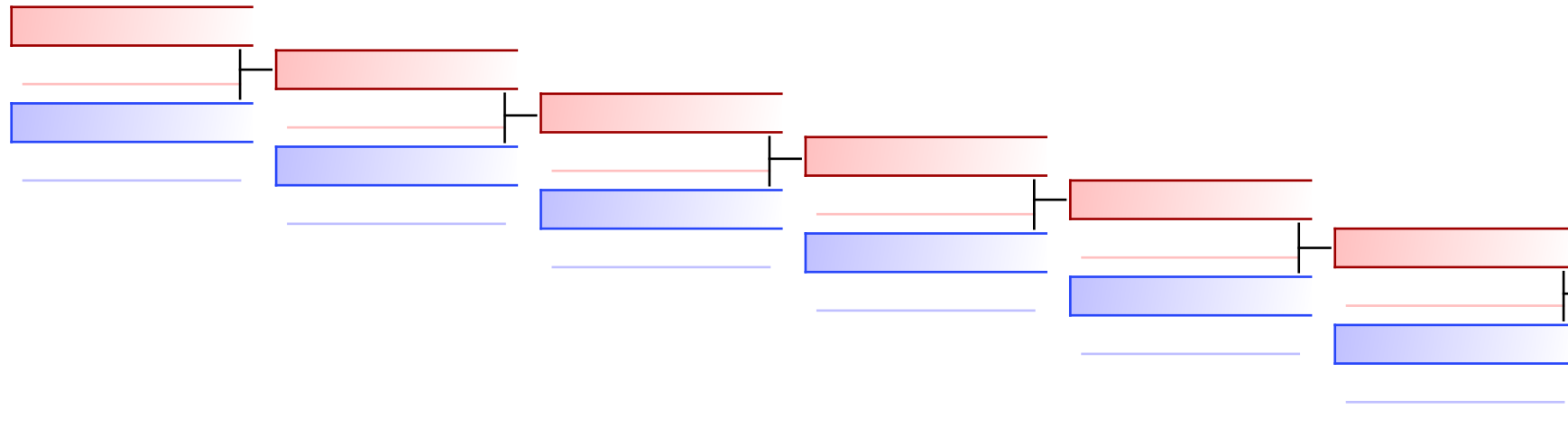

Redzic Esma (SUI) 3
Bohoudi Nada (NED) 0

REPECHAGE: (1)

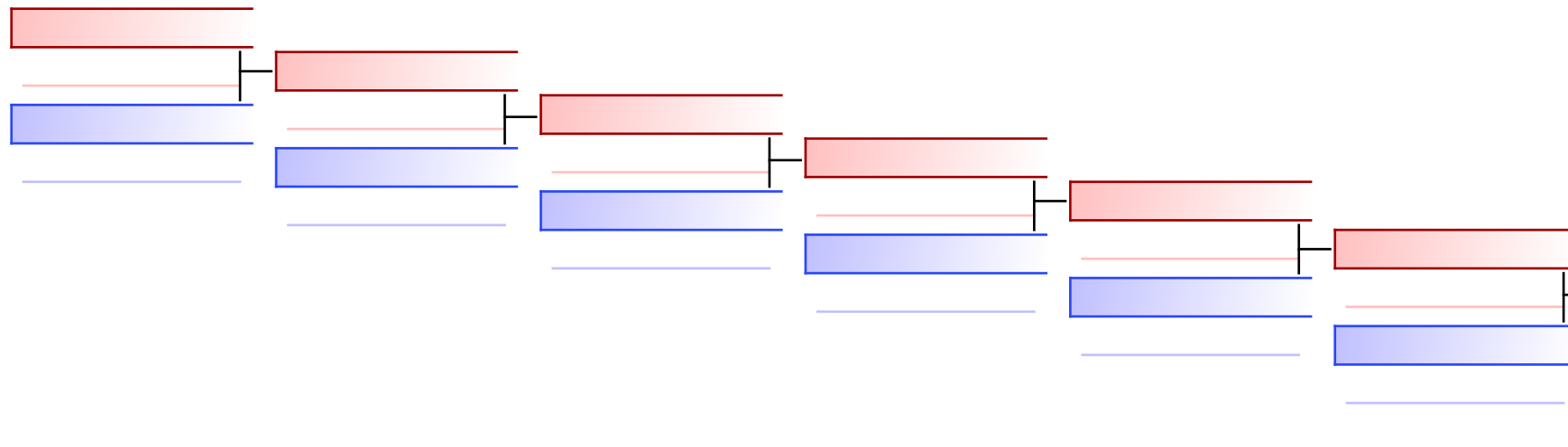

Homri Tesnime (FRA) 3
Olafsson Elena (LUX) 2

Lion Cup 2024 Luxembourg

297 Rue de Reckenthal L-2410 Strassen, LUXEMBOURG

Court Nr.	1	Pool	1	Date	2024-06-08	Field Position	53	
RED				BLUE				
NOC	ALARI SUSAN (SUI)			NOC	OLAFSSON ELENA (LUX)			
Category	Kumite Female U16 +61KG							
3 Points	2 Points	1 Point	Score	1 Point	2 Points	3 Points		
			0 : 2					
Penatlity				Penatlity				
C1: C1, C2:				0:2	C1: C2, C2:			
				Total	WINNER			

Decision of Superiority

Judge 1	Judge 2	Judge 3	Judge 4	Judge 5	Judge 6	Judge 7	Referee

Name _____

Signature _____

Lion Cup 2024 Luxembourg

297 Rue de Reckenthal L-2410 Strassen, LUXEMBOURG

Court Nr.	1	Pool	1	Date	2024-06-08	Field Position	57
RED				BLUE			
NOC	BOHOUDI NADA (NED)			NOC	EROL BERIL (SUI)		
Category	Kumite Female U16 +61KG						
3 Points	2 Points	1 Point	Score	1 Point	2 Points	3 Points	
			2 : 2				
Penatlity				Penatlity			
C1: C3, C2:			2:2	C1: HC, C2:			
WINNER			Total				

Decision of Superiority

Judge 1	Judge 2	Judge 3	Judge 4	Judge 5	Judge 6	Judge 7	Referee

Name _____

Signature _____

Lion Cup 2024 Luxembourg

297 Rue de Reckenthal L-2410 Strassen, LUXEMBOURG

Court Nr.	1	Pool	1	Date	2024-06-08	Field Position	58
RED				BLUE			
NOC	REDZIC ESMA (SUI)			NOC	VANROOY CHIARA (BEL)		
Category	Kumite Female U16 +61KG						
3 Points	2 Points	1 Point	Score	1 Point	2 Points	3 Points	
			0 : 5				
Penatlity				Penatlity			
C1: , C2:			0:5	C1: HC, C2:			
			Total	WINNER			

Decision of Superiority

Judge 1	Judge 2	Judge 3	Judge 4	Judge 5	Judge 6	Judge 7	Referee

Name _____

Signature _____

Lion Cup 2024 Luxembourg

297 Rue de Reckenthal L-2410 Strassen, LUXEMBOURG

Court Nr.	1	Pool	1	Date	2024-06-08	Field Position	59
RED				BLUE			
NOC	OLAFSSON ELENA (LUX)			NOC	VEER FIANE (NED)		
Category	Kumite Female U16 +61KG						
3 Points	2 Points	1 Point	Score	1 Point	2 Points	3 Points	
			3 : 0				
Penatlity				Penatlity			
C1: C2, C2:				3:0	C1: , C2:		
WINNER				Total			

Decision of Superiority

Judge 1	Judge 2	Judge 3	Judge 4	Judge 5	Judge 6	Judge 7	Referee

Name _____

Signature _____

Lion Cup 2024 Luxembourg

297 Rue de Reckenthal L-2410 Strassen, LUXEMBOURG

Court Nr.	1	Pool	1	Date	2024-06-08	Field Position	60
RED				BLUE			
NOC	SRIDI MAISSA (BEL)			NOC	HOMRI TESNIME (FRA)		
Category	Kumite Female U16 +61KG						
3 Points	2 Points	1 Point	Score	1 Point	2 Points	3 Points	
			1 : 0				
Penatlity				Penatlity			
C1: HC, C2:			1:0	C1: , C2:			
WINNER			Total				

Decision of Superiority

Judge 1	Judge 2	Judge 3	Judge 4	Judge 5	Judge 6	Judge 7	Referee

Name _____

Signature _____

Lion Cup 2024 Luxembourg

297 Rue de Reckenthal L-2410 Strassen, LUXEMBOURG

Court Nr.	1	Pool	1	Date	2024-06-08	Field Position	61
RED				BLUE			
NOC	BOHOUDI NADA (NED)			NOC	VANROOY CHIARA (BEL)		
Category	Kumite Female U16 +61KG						
3 Points	2 Points	1 Point	Score	1 Point	2 Points	3 Points	
			1 : 1				
Penatlity				Penatlity			
C1: , C2:			1:1	C1: , C2:			
			Total	WINNER			

Decision of Superiority

Judge 1	Judge 2	Judge 3	Judge 4	Judge 5	Judge 6	Judge 7	Referee

Name _____

Signature _____

Lion Cup 2024 Luxembourg

297 Rue de Reckenthal L-2410 Strassen, LUXEMBOURG

Court Nr.	1	Pool	1	Date	2024-06-08	Field Position	62
RED				BLUE			
NOC	OLAFSSON ELENA (LUX)			NOC	SRIDI MAISSA (BEL)		
Category	Kumite Female U16 +61KG						
3 Points	2 Points	1 Point	Score	1 Point	2 Points	3 Points	
			2 : 4				
Penatlity				Penatlity			
C1: , C2:				2:4	C1: C2, C2:		
				Total	WINNER		

Decision of Superiority

Judge 1	Judge 2	Judge 3	Judge 4	Judge 5	Judge 6	Judge 7	Referee

Name _____

Signature _____

Lion Cup 2024 Luxembourg

297 Rue de Reckenthal L-2410 Strassen, LUXEMBOURG

Court Nr.	1	Pool	1	Date	2024-06-08	Field Position	63	
RED				BLUE				
NOC	VANROOY CHIARA (BEL)			NOC	SRIDI MAISSA (BEL)			
Category	Kumite Female U16 +61KG							
3 Points	2 Points	1 Point	Score	1 Point	2 Points	3 Points		
			0 : 6					
Penatlity				Penatlity				
C1: , C2:				0:6	C1: C1, C2:			
				Total	WINNER			

Decision of Superiority

Judge 1	Judge 2	Judge 3	Judge 4	Judge 5	Judge 6	Judge 7	Referee

Name _____

Signature _____

Lion Cup 2024 Luxembourg

297 Rue de Reckenthal L-2410 Strassen, LUXEMBOURG

Court Nr.	1	Pool	1	Date	2024-06-08	Field Position	0
RED				BLUE			
NOC	REDZIC ESMA (SUI)			NOC	BOHOUDI NADA (NED)		
Category	Kumite Female U16 +61KG						
3 Points	2 Points	1 Point	Score	1 Point	2 Points	3 Points	
			:				
Penatlity				Penatlity			
			Total				

Decision of Superiority

Judge 1	Judge 2	Judge 3	Judge 4	Judge 5	Judge 6	Judge 7	Referee

Name _____

Signature _____

Lion Cup 2024 Luxembourg

297 Rue de Reckenthal L-2410 Strassen, LUXEMBOURG

Court Nr.	2	Pool	2	Date	2024-06-08	Field Position	0	
RED				BLUE				
NOC	HOMRI TESNIME (FRA)			NOC	OLAFSSON ELENA (LUX)			
Category	Kumite Female U16 +61KG							
3 Points	2 Points	1 Point	Score	1 Point	2 Points	3 Points		
			3 : 2					
Penatlity				Penatlity				
C1: C3, C2:				3:2	C1: C3, C2:			
WINNER				Total				

Decision of Superiority

Judge 1	Judge 2	Judge 3	Judge 4	Judge 5	Judge 6	Judge 7	Referee

Name _____

Signature _____

Official Results

Kumite Female U16 +61KG			
1	SRIDI MAISSA		BEL - BELGIUM
2	VANROOY CHIARA		BEL - BELGIUM
3	REDZIC ESMA		SUI - SWITZERLAND
3	HOMRI TESNIME		FRA - FRANCE
5	BOHOUDI NADA		NED - NETHERLANDS
5	OLAFSSON ELENA		LUX - LUXEMBOURG

KUMITE FEMALE U16 - 61KG

Lion Cup 2024 Luxembourg

ENTRIES BY WEIGHT CATEGORY
Kumite Female U16 - 61KG

As of 8 JUN 2024

NOC Code	Gender	Name	Seeding
ALG	F	FAREH RIM	
AUT	F	Kovacevic Leoni	
BEL	F	EL LAHIOUI Alham	
BEL	F	Rejraji Yasmine	
BEL	F	Tamburrini Titia	
FRA	F	Mekhane Hania	
FRA	F	SEKETELI Eloise	
FRA	F	Shabayek Malak	
FRA	F	YORO Eden	
LUX	F	De Rubeis Giulia	
LUX	F	Pierre Abby	
NED	F	Bohoudi Mayssan	
NED	F	Jong de Anniek	
NED	F	Polianska Olena	
NOR	F	Cole Eirin Kristine	
SUI	F	Arifagic Almina	
SUI	F	Gibril Hiba	
SUI	F	Gres sara	
SUI	F	Mühlemann Noemi Emma	

Kumite Female U16 - 61KG

Lion Cup 2024 Luxembourg, 297 Rue de Reckenthal L-2410 Strassen, LUX

2024-06-08

Tatami
5 15:45

Pool
1 / 1

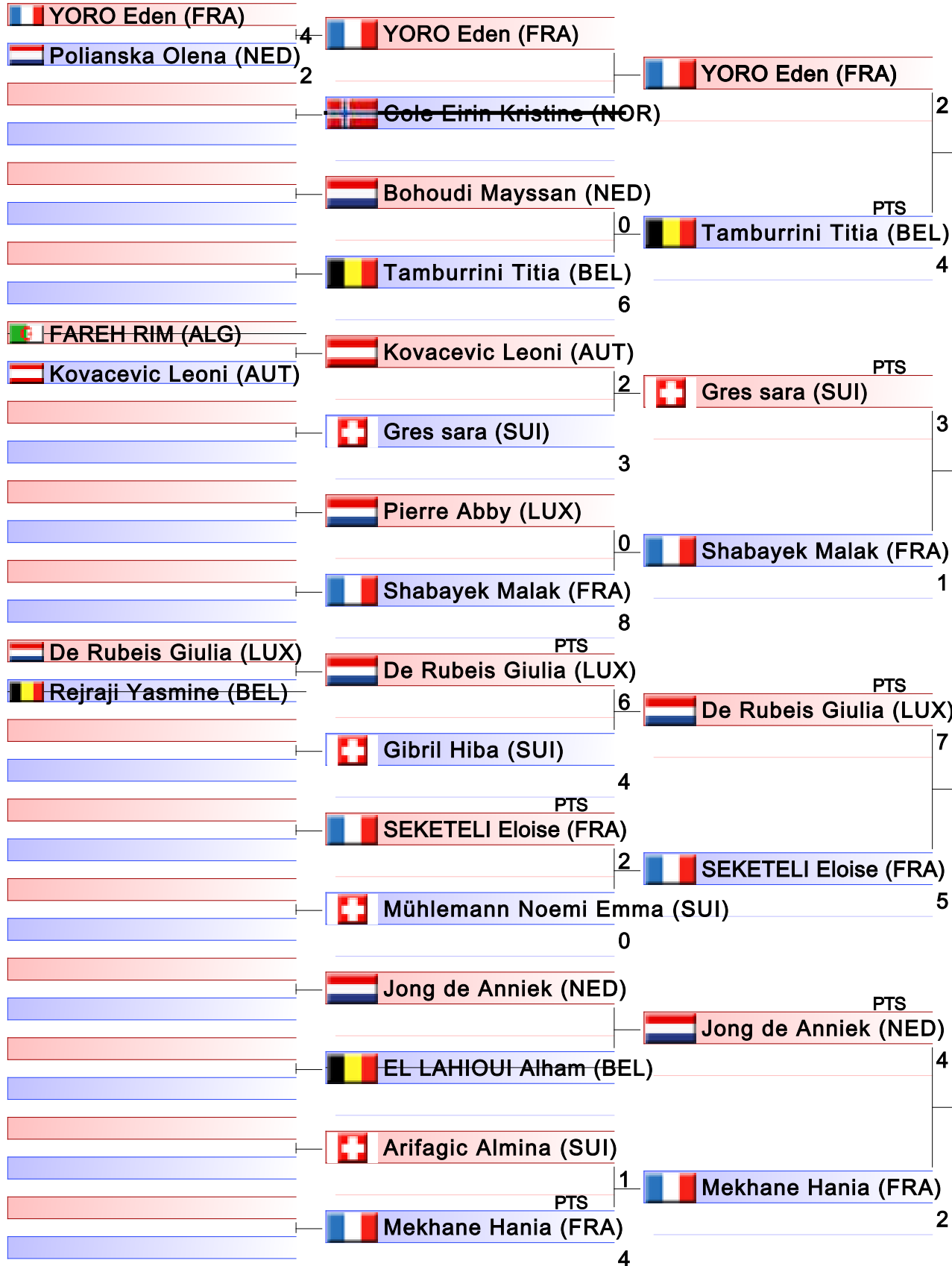

Final

1. DE RUBEIS GIULIA (LUX)
2. TAMBURRINI TITIA (BEL)
3. YORO EDEN (FRA)
3. JONG DE ANNIEK (NED)
5. GRES SARA (SUI)
5. GIBRIL HIBA (SUI)
7. BOHOUDI MAYSSAN (NED)
7. SEKETELI ELOISE (FRA)

Kumite Female U16 - 61KG

Lion Cup 2024 Luxembourg

2024-06-08

Tatami
5 16:50

Pool
1

(c)sportdata GmbH & Co KG 2000-2024 (2024-06-08 18:41) v 10.1.0 build 1 (2024-01-24 23:23 CET) License: Online_Event_ID-7672_LionCup2024Luxembourg (expire 2024-06-21)

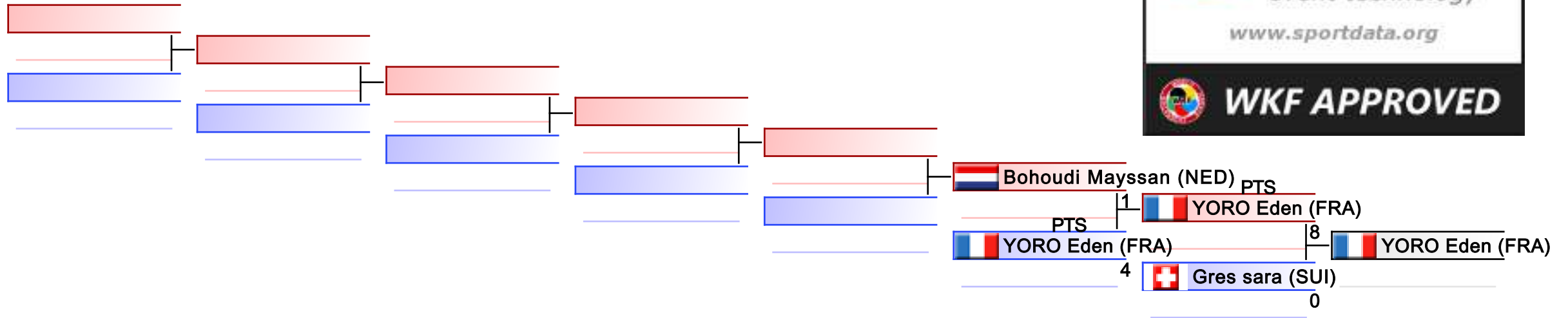

REPECHAGE: (1)

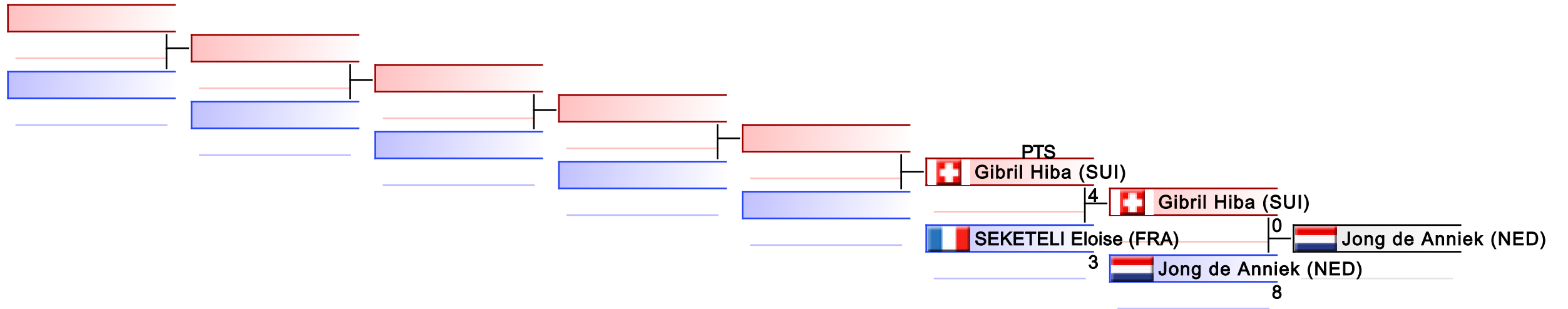

Lion Cup 2024 Luxembourg

297 Rue de Reckenthal L-2410 Strassen, LUXEMBOURG

Court Nr.	1	Pool	1	Date	2024-06-08	Field Position	33	
RED				BLUE				
NOC	YORO EDEN (FRA)			NOC	POLIANSKA OLENA (NED)			
Category	Kumite Female U16 - 61KG							
3 Points	2 Points	1 Point	Score	1 Point	2 Points	3 Points		
			4 : 2					
Penatlity				Penatlity				
C1: HC, C2:				4:2	C1: , C2:			
WINNER				Total				

Decision of Superiority

Judge 1	Judge 2	Judge 3	Judge 4	Judge 5	Judge 6	Judge 7	Referee

Name _____

Signature _____

Lion Cup 2024 Luxembourg

297 Rue de Reckenthal L-2410 Strassen, LUXEMBOURG

Court Nr.	1	Pool	1	Date	2024-06-08	Field Position	50	
RED				BLUE				
NOC	BOHOUDI MAYSSAN (NED)			NOC	TAMBURRINI TITIA (BEL)			
Category	Kumite Female U16 - 61KG							
3 Points	2 Points	1 Point	Score	1 Point	2 Points	3 Points		
			0 : 6					
Penatlity				Penatlity				
C1: C3, C2:				0:6	C1: C1, C2:			
				Total	WINNER			

Decision of Superiority

Judge 1	Judge 2	Judge 3	Judge 4	Judge 5	Judge 6	Judge 7	Referee

Name _____

Signature _____

Lion Cup 2024 Luxembourg

297 Rue de Reckenthal L-2410 Strassen, LUXEMBOURG

Court Nr.	1	Pool	1	Date	2024-06-08	Field Position	51	
RED				BLUE				
NOC	KOVACEVIC LEONI (AUT)			NOC	GRES SARA (SUI)			
Category	Kumite Female U16 - 61KG							
3 Points	2 Points	1 Point	Score	1 Point	2 Points	3 Points		
			2 : 3					
Penatlity				Penatlity				
C1: C1, C2:				2:3	C1: C1, C2:			
				Total	WINNER			

Decision of Superiority

Judge 1	Judge 2	Judge 3	Judge 4	Judge 5	Judge 6	Judge 7	Referee

Name _____

Signature _____

Lion Cup 2024 Luxembourg

297 Rue de Reckenthal L-2410 Strassen, LUXEMBOURG

Court Nr.	1	Pool	1	Date	2024-06-08	Field Position	52
RED				BLUE			
NOC	PIERRE ABBY (LUX)			NOC	SHABAYEK MALAK (FRA)		
Category	Kumite Female U16 - 61KG						
3 Points	2 Points	1 Point	Score	1 Point	2 Points	3 Points	
			0 : 8				
Penatlity				Penatlity			
C1: , C2:			0:8	C1: C2, C2:			
			Total	WINNER			

Decision of Superiority

Judge 1	Judge 2	Judge 3	Judge 4	Judge 5	Judge 6	Judge 7	Referee

Name _____

Signature _____

Lion Cup 2024 Luxembourg

297 Rue de Reckenthal L-2410 Strassen, LUXEMBOURG

Court Nr.	1	Pool	1	Date	2024-06-08	Field Position	53
RED				BLUE			
NOC	DE RUBEIS GIULIA (LUX)			NOC	GIBRIL HIBA (SUI)		
Category	Kumite Female U16 - 61KG						
3 Points	2 Points	1 Point	Score	1 Point	2 Points	3 Points	
			6 : 4				
Penatlity					Penatlity		
C1: C1, C2:				6:4	C1: , C2:		
WINNER				Total			

PTS

Decision of Superiority

Judge 1	Judge 2	Judge 3	Judge 4	Judge 5	Judge 6	Judge 7	Referee

Name _____

Signature _____

Lion Cup 2024 Luxembourg

297 Rue de Reckenthal L-2410 Strassen, LUXEMBOURG

Court Nr.	1	Pool	1	Date	2024-06-08	Field Position	54	
RED				BLUE				
NOC	SEKETELI ELOISE (FRA)			NOC	MHLEMANN NOEMI EMMA (SUI)			
Category	Kumite Female U16 - 61KG							
3 Points	2 Points	1 Point	Score	1 Point	2 Points	3 Points		
			2 : 0					
Penatlity				Penatlity				
C1: C3, C2:				2:0	C1: , C2:			
WINNER				Total				

PTS

Decision of Superiority

Judge 1	Judge 2	Judge 3	Judge 4	Judge 5	Judge 6	Judge 7	Referee

Name _____

Signature _____

Lion Cup 2024 Luxembourg

297 Rue de Reckenthal L-2410 Strassen, LUXEMBOURG

Court Nr.	1	Pool	1	Date	2024-06-08	Field Position	56
RED				BLUE			
NOC	ARIFAGIC ALMINA (SUI)			NOC	MEKHANE HANIA (FRA)		
Category	Kumite Female U16 - 61KG						
3 Points	2 Points	1 Point	Score	1 Point	2 Points	3 Points	
			1 : 4				
Penatlity					Penatlity		
C1: C2, C2:				1:4	C1: , C2:		
				Total	WINNER		

PTS

Decision of Superiority

Judge 1	Judge 2	Judge 3	Judge 4	Judge 5	Judge 6	Judge 7	Referee

Name _____

Signature _____

Lion Cup 2024 Luxembourg

297 Rue de Reckenthal L-2410 Strassen, LUXEMBOURG

Court Nr.	1	Pool	1	Date	2024-06-08	Field Position	57
RED				BLUE			
NOC	YORO EDEN (FRA)			NOC	TAMBURRINI TITIA (BEL)		
Category	Kumite Female U16 - 61KG						
3 Points	2 Points	1 Point	Score	1 Point	2 Points	3 Points	
			2 : 4				
Penatlity				Penatlity			
C1: , C2:			2:4	C1: , C2:			
			Total	WINNER			

PTS

Decision of Superiority

Judge 1	Judge 2	Judge 3	Judge 4	Judge 5	Judge 6	Judge 7	Referee

Name _____

Signature _____

Lion Cup 2024 Luxembourg

297 Rue de Reckenthal L-2410 Strassen, LUXEMBOURG

Court Nr.	1	Pool	1	Date	2024-06-08	Field Position	58
RED				BLUE			
NOC	GRES SARA (SUI)			NOC	SHABAYEK MALAK (FRA)		
Category	Kumite Female U16 - 61KG						
3 Points	2 Points	1 Point	Score	1 Point	2 Points	3 Points	
			3 : 1				
Penatlity				Penatlity			
C1: , C2:			3:1	C1: HC, C2:			
WINNER			Total				

PTS

Decision of Superiority

Judge 1	Judge 2	Judge 3	Judge 4	Judge 5	Judge 6	Judge 7	Referee

Name _____

Signature _____

Lion Cup 2024 Luxembourg

297 Rue de Reckenthal L-2410 Strassen, LUXEMBOURG

Court Nr.	1	Pool	1	Date	2024-06-08	Field Position	59	
RED				BLUE				
NOC	DE RUBEIS GIULIA (LUX)			NOC	SEKETELI ELOISE (FRA)			
Category	Kumite Female U16 - 61KG							
3 Points	2 Points	1 Point	Score	1 Point	2 Points	3 Points		
			7 : 5					
Penatlity				Penatlity				
C1: HC, C2:				7:5	C1: C1, C2:			
WINNER				Total				

PTS

Decision of Superiority

Judge 1	Judge 2	Judge 3	Judge 4	Judge 5	Judge 6	Judge 7	Referee

Name _____

Signature _____

Lion Cup 2024 Luxembourg

297 Rue de Reckenthal L-2410 Strassen, LUXEMBOURG

Court Nr.	1	Pool	1	Date	2024-06-08	Field Position	60	
RED				BLUE				
NOC	JONG DE ANNIEK (NED)			NOC	MEKHANE HANIA (FRA)			
Category	Kumite Female U16 - 61KG							
3 Points	2 Points	1 Point	Score	1 Point	2 Points	3 Points		
			4 : 2					
Penatlity				Penatlity				
C1: C2, C2:				4:2	C1: C1, C2:			
WINNER				Total				

PTS

Decision of Superiority

Judge 1	Judge 2	Judge 3	Judge 4	Judge 5	Judge 6	Judge 7	Referee

Name _____

Signature _____

Lion Cup 2024 Luxembourg

297 Rue de Reckenthal L-2410 Strassen, LUXEMBOURG

Court Nr.	1	Pool	1	Date	2024-06-08	Field Position	61
RED				BLUE			
NOC	TAMBURRINI TITIA (BEL)			NOC	GRES SARA (SUI)		
Category	Kumite Female U16 - 61KG						
3 Points	2 Points	1 Point	Score	1 Point	2 Points	3 Points	
			8 : 0				
Penatlity				Penatlity			
C1: HC, C2:			8:0	C1: C1, C2:			
WINNER			Total				

PTS

Decision of Superiority

Judge 1	Judge 2	Judge 3	Judge 4	Judge 5	Judge 6	Judge 7	Referee

Name _____

Signature _____

Lion Cup 2024 Luxembourg

297 Rue de Reckenthal L-2410 Strassen, LUXEMBOURG

Court Nr.	1	Pool	1	Date	2024-06-08	Field Position	62
RED				BLUE			
NOC	DE RUBEIS GIULIA (LUX)			NOC	JONG DE ANNIEK (NED)		
Category	Kumite Female U16 - 61KG						
3 Points	2 Points	1 Point	Score	1 Point	2 Points	3 Points	
			4 : 2				
Penatlity					Penatlity		
C1: C1, C2:				4:2	C1: C3, C2:		
WINNER				Total			

PTS

Decision of Superiority

Judge 1	Judge 2	Judge 3	Judge 4	Judge 5	Judge 6	Judge 7	Referee

Name _____

Signature _____

Lion Cup 2024 Luxembourg

297 Rue de Reckenthal L-2410 Strassen, LUXEMBOURG

Court Nr.	1	Pool	1	Date	2024-06-08	Field Position	63
RED				BLUE			
NOC	TAMBURRINI TITIA (BEL)			NOC	DE RUBEIS GIULIA (LUX)		
Category	Kumite Female U16 - 61KG						
3 Points	2 Points	1 Point	Score	1 Point	2 Points	3 Points	
			3 : 7				
Penatlity				Penatlity			
C1: , C2:			3:7	C1: C1, C2:			
			Total	WINNER			

PTS

Decision of Superiority

Judge 1	Judge 2	Judge 3	Judge 4	Judge 5	Judge 6	Judge 7	Referee

Name _____

Signature _____

Lion Cup 2024 Luxembourg

297 Rue de Reckenthal L-2410 Strassen, LUXEMBOURG

Court Nr.	1	Pool	1	Date	2024-06-08	Field Position	0
RED				BLUE			
NOC	YORO EDEN (FRA)			NOC	GRES SARA (SUI)		
Category	Kumite Female U16 - 61KG						
3 Points	2 Points	1 Point	Score	1 Point	2 Points	3 Points	
			8 : 0				
Penatlity				Penatlity			
C1: C2, C2:				8:0	C1: , C2:		
WINNER				Total			

PTS

Decision of Superiority

Judge 1	Judge 2	Judge 3	Judge 4	Judge 5	Judge 6	Judge 7	Referee

Name _____

Signature _____

Lion Cup 2024 Luxembourg

297 Rue de Reckenthal L-2410 Strassen, LUXEMBOURG

Court Nr.	1	Pool	1	Date	2024-06-08	Field Position	2
RED				BLUE			
NOC	BOHOUDI MAYSSAN (NED)			NOC	YORO EDEN (FRA)		
Category	Kumite Female U16 - 61KG						
3 Points	2 Points	1 Point	Score	1 Point	2 Points	3 Points	
			:				
Penatlity				Penatlity			
			Total				

Decision of Superiority

Judge 1	Judge 2	Judge 3	Judge 4	Judge 5	Judge 6	Judge 7	Referee

Name _____

Signature _____

Lion Cup 2024 Luxembourg

297 Rue de Reckenthal L-2410 Strassen, LUXEMBOURG

Court Nr.	2	Pool	2	Date	2024-06-08	Field Position	0
RED				BLUE			
NOC	GIBRIL HIBA (SUI)			NOC	JONG DE ANNIEK (NED)		
Category	Kumite Female U16 - 61KG						
3 Points	2 Points	1 Point	Score	1 Point	2 Points	3 Points	
			0 : 8				
Penatlity				Penatlity			
C1: , C2:			0:8	C1: , C2:			
			Total	WINNER			

Decision of Superiority

Judge 1	Judge 2	Judge 3	Judge 4	Judge 5	Judge 6	Judge 7	Referee

Name _____

Signature _____

Lion Cup 2024 Luxembourg

297 Rue de Reckenthal L-2410 Strassen, LUXEMBOURG

Court Nr.	2	Pool	2	Date	2024-06-08	Field Position	2
RED				BLUE			
NOC	GIBRIL HIBA (SUI)			NOC	SEKETELI ELOISE (FRA)		
Category	Kumite Female U16 - 61KG						
3 Points	2 Points	1 Point	Score	1 Point	2 Points	3 Points	
			4 : 3				
Penatlity				Penatlity			
C1: HC, C2:				4:3	C1: , C2:		
WINNER				Total			

PTS

Decision of Superiority

Judge 1	Judge 2	Judge 3	Judge 4	Judge 5	Judge 6	Judge 7	Referee

Name _____

Signature _____

Lion Cup 2024 Luxembourg - 2024-06-07

Official Results

Kumite Female U16 - 61KG			
1	DE RUBEIS GIULIA		LUX - LUXEMBOURG
2	TAMBURRINI TITIA		BEL - BELGIUM
3	YORO EDEN		FRA - FRANCE
3	JONG DE ANNIEK		NED - NETHERLANDS
5	GRES SARA		SUI - SWITZERLAND
5	GIBRIL HIBA		SUI - SWITZERLAND
7	BOHOUDI MAYSSAN		NED - NETHERLANDS
7	SEKETELI ELOISE		FRA - FRANCE

KUMITE FEMALE U18 -48KG

Lion Cup 2024 Luxembourg

ENTRIES BY WEIGHT CATEGORY
Kumite Female U18 -48kg

As of 8 JUN 2024

NOC Code	Gender	Name	Seeding
LUX	F	Moens Alix	
LUX	F	Szabo Malna	
SUI	F	Wysbrod Selin	

Kumite Female U18 -48kg - Round Robin (each against each)

Lion Cup 2024 Luxembourg, 297 Rue de Reckenthal L-2410 Strassen, LUX

2024-06-08

Tatami
5 10:05

Pool
1 / 1

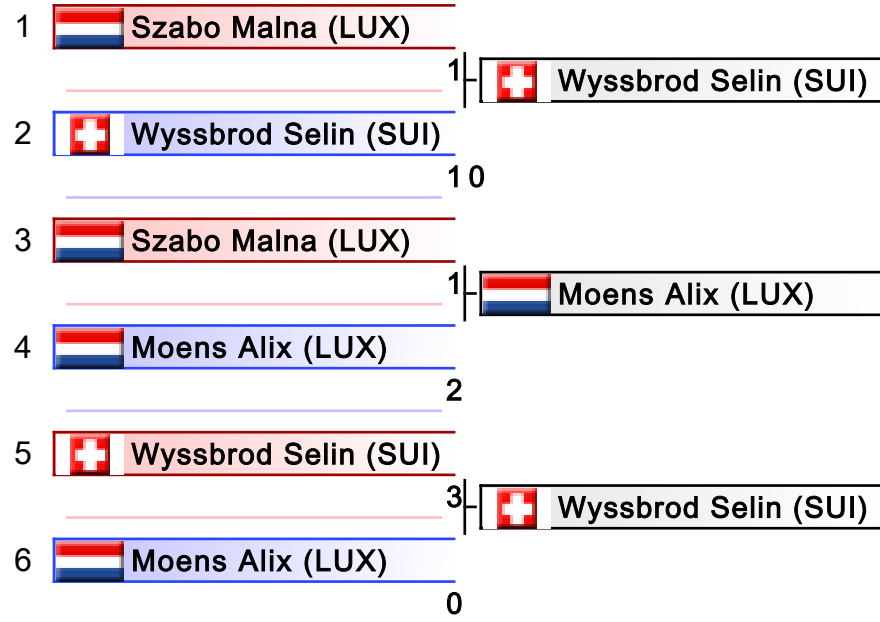

1. WYSSBROD SELIN (SUI)
2. MOENS ALIX (LUX)
3. SZABO MALNA (LUX)

Lion Cup 2024 Luxembourg

297 Rue de Reckenthal L-2410 Strassen, LUXEMBOURG

Court Nr.	1	Pool	1	Date	2024-06-08	Field Position	-9951
RED				BLUE			
NOC	SZABO MALNA (LUX)			NOC	WYSSBROD SELIN (SUI)		
Category	Kumite Female U18 -48kg						
3 Points	2 Points	1 Point	Score	1 Point	2 Points	3 Points	
			1 : 10				
Penatlity				Penatlity			
C1: C1, C2:			1:10	C1: HC, C2:			
			Total	WINNER			

Decision of Superiority

Judge 1	Judge 2	Judge 3	Judge 4	Judge 5	Judge 6	Judge 7	Referee

Name _____

Signature _____

Lion Cup 2024 Luxembourg

297 Rue de Reckenthal L-2410 Strassen, LUXEMBOURG

Court Nr.	1	Pool	1	Date	2024-06-08	Field Position	-9950
RED				BLUE			
NOC	SZABO MALNA (LUX)			NOC	MOENS ALIX (LUX)		
Category	Kumite Female U18 -48kg						
3 Points	2 Points	1 Point	Score	1 Point	2 Points	3 Points	
			1 : 2				
Penatlity				Penatlity			
C1: , C2:			1:2	C1: C1, C2:			
			Total	WINNER			

Decision of Superiority

Judge 1	Judge 2	Judge 3	Judge 4	Judge 5	Judge 6	Judge 7	Referee

Name _____

Signature _____

Lion Cup 2024 Luxembourg

297 Rue de Reckenthal L-2410 Strassen, LUXEMBOURG

Court Nr.	1	Pool	1	Date	2024-06-08	Field Position	-9949
RED				BLUE			
NOC	WYSSBROD SELIN (SUI)			NOC	MOENS ALIX (LUX)		
Category	Kumite Female U18 -48kg						
3 Points	2 Points	1 Point	Score	1 Point	2 Points	3 Points	
			3 : 0				
Penatlity				Penatlity			
C1: C2, C2:				3:0	C1: C2, C2:		
WINNER				Total			

Decision of Superiority



Judge 1	Judge 2	Judge 3	Judge 4	Judge 5	Judge 6	Judge 7	Referee

Name _____

Signature _____

Lion Cup 2024 Luxembourg - 2024-06-07

Official Results

Kumite Female U18 -48kg			
1	WYSSBROD SELIN		SUI - SWITZERLAND
2	MOENS ALIX		LUX - LUXEMBOURG
3	SZABO MALNA		LUX - LUXEMBOURG

KUMITE FEMALE U18 -53KG

Lion Cup 2024 Luxembourg

ENTRIES BY WEIGHT CATEGORY
Kumite Female U18 -53kg

As of 8 JUN 2024

NOC Code	Gender	Name	Seeding
ALG	F	MOUGHARI ROUIA RAOUANE	
BEL	F	DAUBY ANAELLE	
BEL	F	EL HOUDIFI Anissa	
BEL	F	Yuksektepe Asya	
DEN	F	Aakerman Sofia Lundquist	
LUX	F	Martins Dias Gabriela	
NED	F	de Haan Fama	
NED	F	Djuric Jelena	
NED	F	Voorduin Alyssia	
SUI	F	Paul-Jacques Juline	
SUI	F	Vignogna Vivien	

Kumite Female U18 -53kg

Lion Cup 2024 Luxembourg, 297 Rue de Reckenthal L-2410 Strassen, LUX

2024-06-08

Tatami
4 10:20

Pool
1 / 1

~~DAUBY ANAELLE (BEL)~~

0 | ~~MOUGHARI ROUIA RAOUANE (ALG)~~

~~MOUGHARI ROUIA RAOUANE (ALG)~~

0 |

~~Voorduin Alyssia (NED)~~

1 |

~~Voorduin Alyssia (NED)~~

1 |

Final

~~Voorduin Alyssia (NED)~~

1 |

~~Vignogna Vivien (SUI)~~

0 |

~~Yuksektepe Asya (BEL)~~

0 |

~~Yuksektepe Asya (BEL)~~

5 |

~~Aakerman Sofia Lundquist (DEN)~~

0 | ~~de Haan Fama (NED)~~

~~de Haan Fama (NED)~~

0 |

~~Paul-Jacques Juline (SUI)~~

0 |

~~Paul-Jacques Juline (SUI)~~

0 |

~~Martins Dias Gabriela (LUX)~~

0 |

~~EL HOUDIFI Anissa (BEL)~~

0 |

~~Martins Dias Gabriela (LUX)~~

1 |

~~Martins Dias Gabriela (LUX)~~

8 |

~~Voorduin Alyssia (NED)~~

- | |
|--------------------------------|
| 1. VOORDUIN ALYSSIA (NED) |
| 2. MARTINS DIAS GABRIELA (LUX) |
| 3. YUKSEKTEPE ASYA (BEL) |
| 3. EL HOUDIFI ANISSA (BEL) |
| 5. PAUL-JACQUES JULINE (SUI) |
| |
| |



Kumite Female U18 -53kg

Lion Cup 2024 Luxembourg

2024-06-08

Tatami
4 11:05

Pool
1

(c)sportdata GmbH & Co KG 2000-2024 (2024-06-08 18:41) v 10.1.0 build 1 (2024-01-24 23:23 CET) License: Online_Event_ID-7672_LionCup2024Luxembourg (expire 2024-06-21)

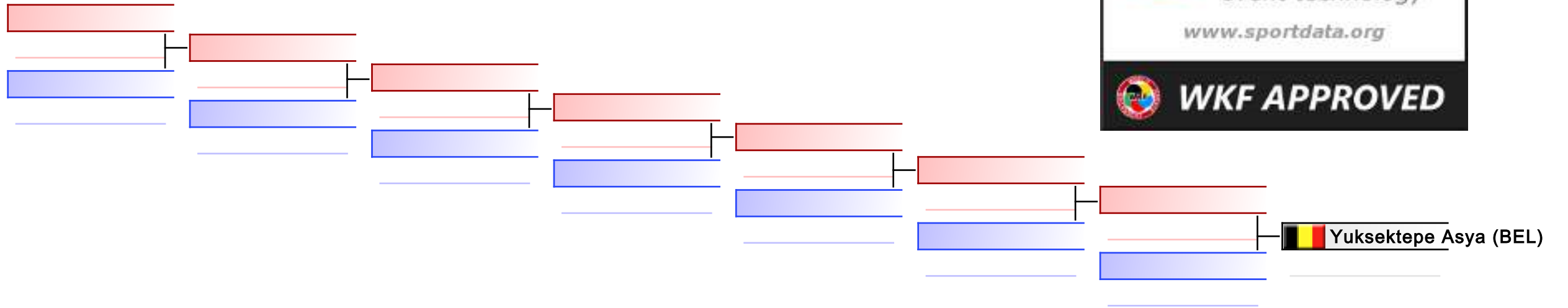

REPECHAGE: (1)

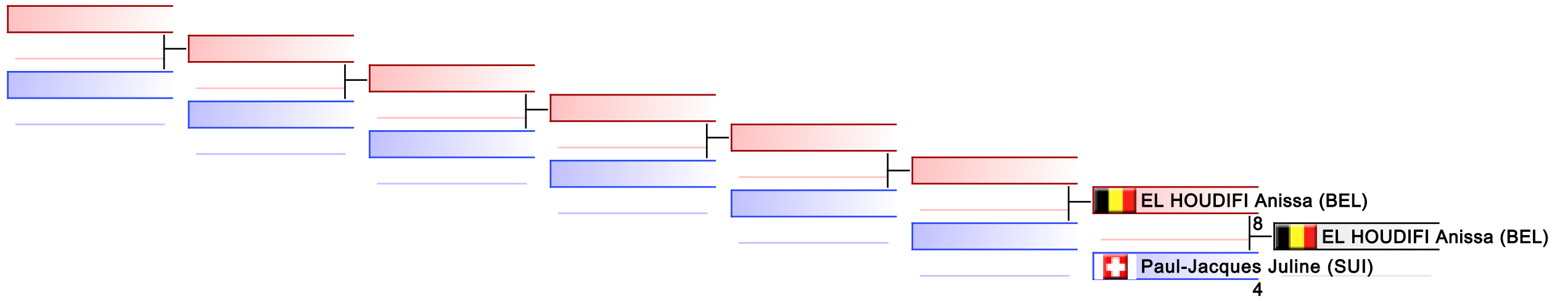

Lion Cup 2024 Luxembourg

297 Rue de Reckenthal L-2410 Strassen, LUXEMBOURG

Court Nr.	1	Pool	1	Date	2024-06-08	Field Position	58
RED				BLUE			
NOC	VIGNOGNA VIVIEN (SUI)			NOC	YUKSEKTEPE ASYA (BEL)		
Category	Kumite Female U18 -53kg						
3 Points	2 Points	1 Point	Score	1 Point	2 Points	3 Points	
			0 : 5				
Penatlity				Penatlity			
C1: , C2:				0:5	C1: C1, C2:		
				Total	WINNER		

Decision of Superiority

Judge 1	Judge 2	Judge 3	Judge 4	Judge 5	Judge 6	Judge 7	Referee

Name _____

Signature _____

Lion Cup 2024 Luxembourg

297 Rue de Reckenthal L-2410 Strassen, LUXEMBOURG

Court Nr.	1	Pool	1	Date	2024-06-08	Field Position	59
RED				BLUE			
NOC	DE HAAN FAMA (NED)			NOC	PAUL-JACQUES JULINE (SUI)		
Category	Kumite Female U18 -53kg						
3 Points	2 Points	1 Point	Score	1 Point	2 Points	3 Points	
			0 : 0				
Penatlity				Penatlity			
C1: , C2:				0:0	C1: , C2:		
				Total	WINNER		

Decision of Superiority

Judge 1	Judge 2	Judge 3	Judge 4	Judge 5	Judge 6	Judge 7	Referee

Name _____

Signature _____

Lion Cup 2024 Luxembourg

297 Rue de Reckenthal L-2410 Strassen, LUXEMBOURG

Court Nr.	1	Pool	1	Date	2024-06-08	Field Position	60	
RED				BLUE				
NOC	EL HOUDIFI ANISSA (BEL)			NOC	MARTINS DIAS GABRIELA (LUX)			
Category	Kumite Female U18 -53kg							
3 Points	2 Points	1 Point	Score	1 Point	2 Points	3 Points		
			0 : 8					
Penatlity				Penatlity				
C1: , C2:				0:8	C1: C1, C2:			
				Total	WINNER			

Decision of Superiority

Judge 1	Judge 2	Judge 3	Judge 4	Judge 5	Judge 6	Judge 7	Referee

Name _____

Signature _____

Lion Cup 2024 Luxembourg

297 Rue de Reckenthal L-2410 Strassen, LUXEMBOURG

Court Nr.	1	Pool	1	Date	2024-06-08	Field Position	61
RED				BLUE			
NOC	VOORDUIN ALYSSIA (NED)			NOC	YUKSEKTEPE ASYA (BEL)		
Category	Kumite Female U18 -53kg						
3 Points	2 Points	1 Point	Score	1 Point	2 Points	3 Points	
			1 : 0				
Penatlity				Penatlity			
C1: C1, C2:				1:0	C1: C2, C2:		
WINNER				Total			

Decision of Superiority

Judge 1	Judge 2	Judge 3	Judge 4	Judge 5	Judge 6	Judge 7	Referee

Name _____

Signature _____

Lion Cup 2024 Luxembourg

297 Rue de Reckenthal L-2410 Strassen, LUXEMBOURG

Court Nr.	1	Pool	1	Date	2024-06-08	Field Position	62
RED				BLUE			
NOC	PAUL-JACQUES JULINE (SUI)			NOC	MARTINS DIAS GABRIELA (LUX)		
Category	Kumite Female U18 -53kg						
3 Points	2 Points	1 Point	Score	1 Point	2 Points	3 Points	
			0 : 1				
Penatlity				Penatlity			
C1: , C2:				0:1	C1: , C2:		
				Total	WINNER		

Decision of Superiority

Judge 1	Judge 2	Judge 3	Judge 4	Judge 5	Judge 6	Judge 7	Referee

Name _____

Signature _____

Lion Cup 2024 Luxembourg

297 Rue de Reckenthal L-2410 Strassen, LUXEMBOURG

Court Nr.	1	Pool	1	Date	2024-06-08	Field Position	63	
RED				BLUE				
NOC	VOORDUIN ALYSSIA (NED)			NOC	MARTINS DIAS GABRIELA (LUX)			
Category	Kumite Female U18 -53kg							
3 Points	2 Points	1 Point	Score	1 Point	2 Points	3 Points		
			1 : 0					
Penatlity				Penatlity				
C1: , C2:				1:0	C1: C2, C2:			
WINNER				Total				

Decision of Superiority

Judge 1	Judge 2	Judge 3	Judge 4	Judge 5	Judge 6	Judge 7	Referee

Name _____

Signature _____

Lion Cup 2024 Luxembourg

297 Rue de Reckenthal L-2410 Strassen, LUXEMBOURG

Court Nr.	2	Pool	2	Date	2024-06-08	Field Position	0
RED				BLUE			
NOC	EL HOUDIFI ANISSA (BEL)			NOC	PAUL-JACQUES JULINE (SUI)		
Category	Kumite Female U18 -53kg						
3 Points	2 Points	1 Point	Score	1 Point	2 Points	3 Points	
			:				
Penatlity				Penatlity			
			Total				





Decision of Superiority

Judge 1	Judge 2	Judge 3	Judge 4	Judge 5	Judge 6	Judge 7	Referee

Name _____

Signature _____

Official Results

Kumite Female U18 -53kg			
1	VOORDUIN ALYSSIA		NED - NETHERLANDS
2	MARTINS DIAS GABRIELA		LUX - LUXEMBOURG
3	YUKSEKTEPE ASYA		BEL - BELGIUM
3	EL HOUDIFI ANISSA		BEL - BELGIUM
5	PAUL-JACQUES JULINE		SUI - SWITZERLAND

KUMITE FEMALE U18 -59KG

Lion Cup 2024 Luxembourg

ENTRIES BY WEIGHT CATEGORY
Kumite Female U18 -59kg

As of 8 JUN 2024

NOC Code	Gender	Name	Seeding
AUT	F	Lehner Leonie	
BEL	F	Aur�lie Antoine	
BEL	F	MAATOUG Nargesse	
BEL	F	Mansour Dounya	
FRA	F	PICAZO LUQUE ELEONORE	
LUX	F	AALALA Samia	
LUX	F	Gawellek Sarah	
NED	F	Kashash Nour	
NED	F	Unruh Mirja	
SUI	F	B�rki Danicha	
SUI	F	Guye Nina	
SUI	F	Streit Kim Lara	

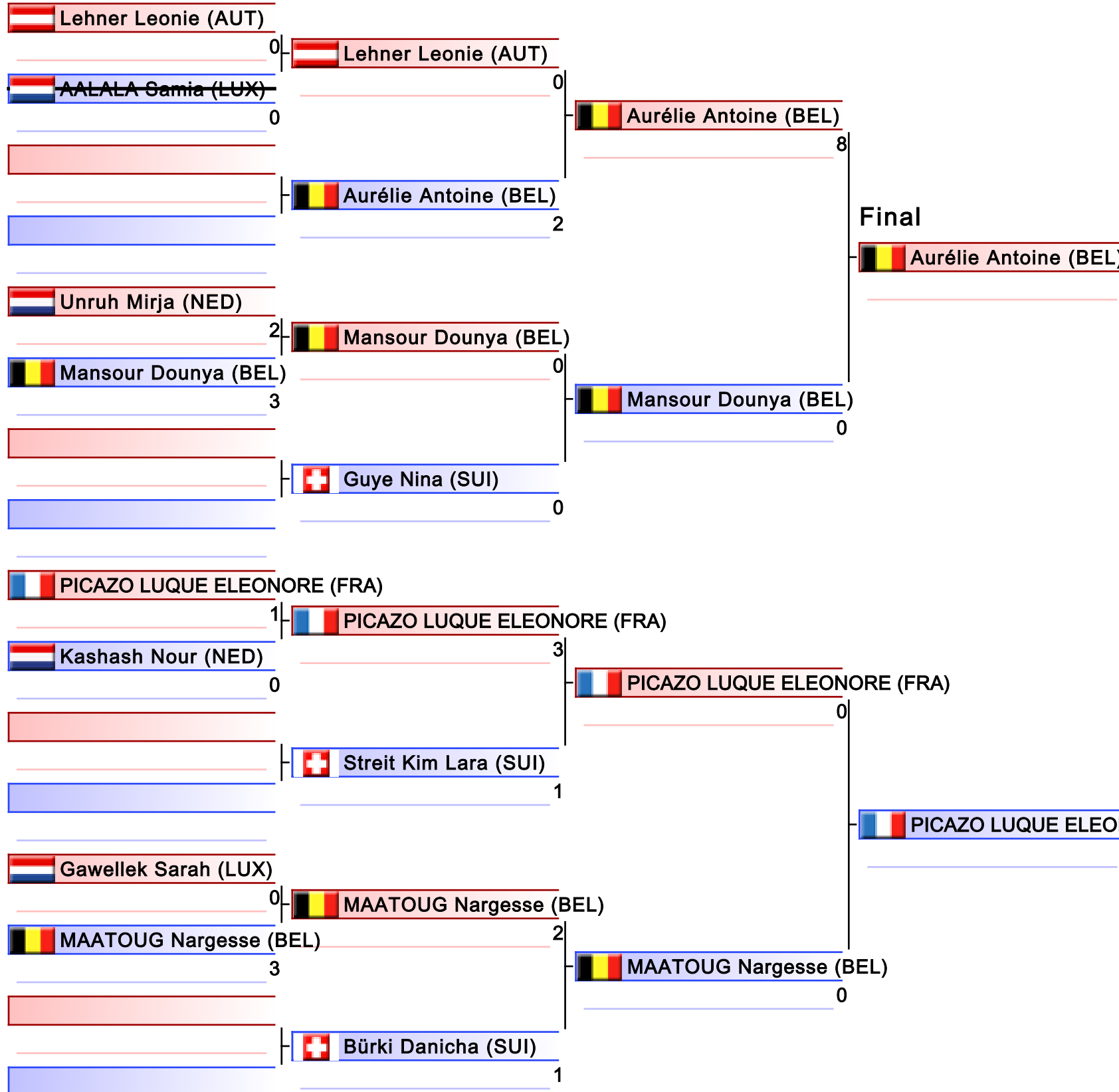

1. PICAZO LUQUE ELEONORE (FRA)
2. AURÉLIE ANTOINE (BEL)
3. MANSOUR DOUNYA (BEL)
3. MAATOUG NARGESSE (BEL)
5. LEHNER LEONIE (AUT)
5. KASHASH NOUR (NED)
7. STREIT KIM LARA (SUI)

Kumite Female U18 -59kg

Lion Cup 2024 Luxembourg

2024-06-08

Tatami
5 11:05

Pool
1

(c)sportdata GmbH & Co KG 2000-2024 (2024-06-08 18:41) v 10.1.0 build 1 (2024-01-24 23:23 CET) License: Online_Event_ID-7672_LionCup2024Luxembourg (expire 2024-06-21)

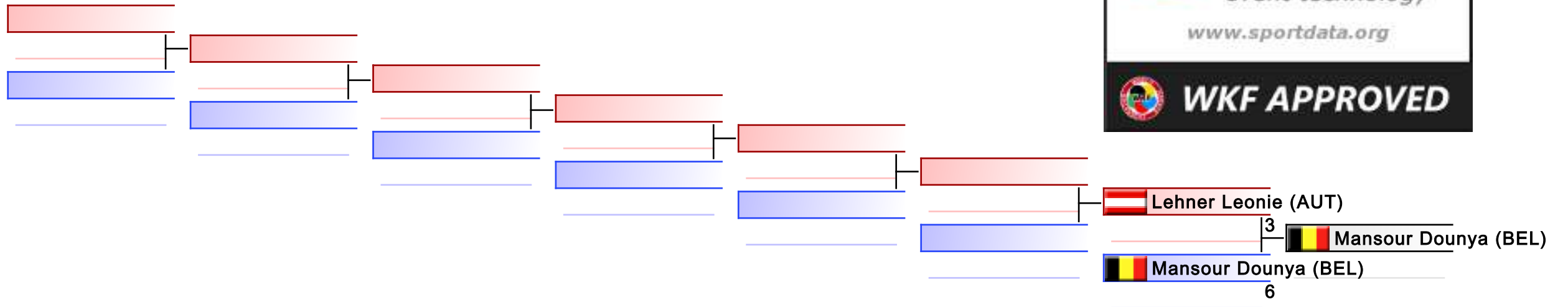

REPECHAGE: (1)

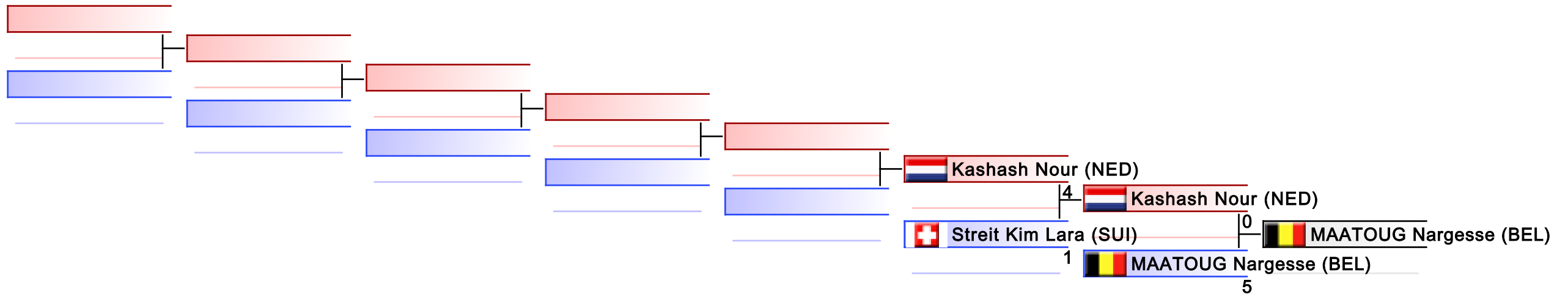

Lion Cup 2024 Luxembourg

297 Rue de Reckenthal L-2410 Strassen, LUXEMBOURG

Court Nr.	1	Pool	1	Date	2024-06-08	Field Position	51	
RED				BLUE				
NOC	UNRUH MIRJA (NED)			NOC	MANSOUR DOUNYA (BEL)			
Category	Kumite Female U18 -59kg							
3 Points	2 Points	1 Point	Score	1 Point	2 Points	3 Points		
			2 : 3					
Penatlity				Penatlity				
C1: C2, C2:				2:3	C1: C1, C2:			
				Total	WINNER			

Decision of Superiority

Judge 1	Judge 2	Judge 3	Judge 4	Judge 5	Judge 6	Judge 7	Referee

Name _____

Signature _____

Lion Cup 2024 Luxembourg

297 Rue de Reckenthal L-2410 Strassen, LUXEMBOURG

Court Nr.	1	Pool	1	Date	2024-06-08	Field Position	53	
RED				BLUE				
NOC	PICAZO LUQUE ELEONORE (FRA)			NOC	KASHASH NOUR (NED)			
Category	Kumite Female U18 -59kg							
3 Points	2 Points	1 Point	Score	1 Point	2 Points	3 Points		
			1 : 0					
Penatlity				Penatlity				
C1: HC, C2:				1:0	C1: C1, C2:			
WINNER				Total				

Decision of Superiority

Judge 1	Judge 2	Judge 3	Judge 4	Judge 5	Judge 6	Judge 7	Referee

Name _____

Signature _____

Lion Cup 2024 Luxembourg

297 Rue de Reckenthal L-2410 Strassen, LUXEMBOURG

Court Nr.	1	Pool	1	Date	2024-06-08	Field Position	55	
RED				BLUE				
NOC	GAWELLEK SARAH (LUX)			NOC	MAATOUG NARGESSE (BEL)			
Category	Kumite Female U18 -59kg							
3 Points	2 Points	1 Point	Score	1 Point	2 Points	3 Points		
			0 : 3					
Penatlity				Penatlity				
C1: C1, C2:				0:3	C1: C1, C2:			
				Total	WINNER			

Decision of Superiority

Judge 1	Judge 2	Judge 3	Judge 4	Judge 5	Judge 6	Judge 7	Referee

Name _____

Signature _____

Lion Cup 2024 Luxembourg

297 Rue de Reckenthal L-2410 Strassen, LUXEMBOURG

Court Nr.	1	Pool	1	Date	2024-06-08	Field Position	57	
RED				BLUE				
NOC	LEHNER LEONIE (AUT)			NOC	AURLIE ANTOINE (BEL)			
Category	Kumite Female U18 -59kg							
3 Points	2 Points	1 Point	Score	1 Point	2 Points	3 Points		
			0 : 2					
Penatlity				Penatlity				
C1: C1, C2:				0:2	C1: HC, C2:			
				Total	WINNER			

Decision of Superiority

Judge 1	Judge 2	Judge 3	Judge 4	Judge 5	Judge 6	Judge 7	Referee

Name _____

Signature _____

Lion Cup 2024 Luxembourg

297 Rue de Reckenthal L-2410 Strassen, LUXEMBOURG

Court Nr.	1	Pool	1	Date	2024-06-08	Field Position	58
RED				BLUE			
NOC	MANSOUR DOUNYA (BEL)			NOC	GUYE NINA (SUI)		
Category	Kumite Female U18 -59kg						
3 Points	2 Points	1 Point	Score	1 Point	2 Points	3 Points	
			0 : 0				
Penatlity				Penatlity			
C1: , C2:				0:0	C1: , C2:		
WINNER				Total			

Decision of Superiority

Judge 1	Judge 2	Judge 3	Judge 4	Judge 5	Judge 6	Judge 7	Referee

Name _____

Signature _____

Lion Cup 2024 Luxembourg

297 Rue de Reckenthal L-2410 Strassen, LUXEMBOURG

Court Nr.	1	Pool	1	Date	2024-06-08	Field Position	59	
RED				BLUE				
NOC	PICAZO LUQUE ELEONORE (FRA)			NOC	STREIT KIM LARA (SUI)			
Category	Kumite Female U18 -59kg							
3 Points	2 Points	1 Point	Score	1 Point	2 Points	3 Points		
			3 : 1					
Penatlity					Penatlity			
C1: C2, C2:				3:1	C1: C1, C2:			
WINNER				Total				

Decision of Superiority

Judge 1	Judge 2	Judge 3	Judge 4	Judge 5	Judge 6	Judge 7	Referee

Name _____

Signature _____

Lion Cup 2024 Luxembourg

297 Rue de Reckenthal L-2410 Strassen, LUXEMBOURG

Court Nr.	1	Pool	1	Date	2024-06-08	Field Position	60	
RED				BLUE				
NOC	MAATOUG NARGESSE (BEL)			NOC	BRKI DANICHA (SUI)			
Category	Kumite Female U18 -59kg							
3 Points	2 Points	1 Point	Score	1 Point	2 Points	3 Points		
			2 : 1					
Penatlity				Penatlity				
C1: HC, C2:				2:1	C1: , C2:			
WINNER				Total				

Decision of Superiority

Judge 1	Judge 2	Judge 3	Judge 4	Judge 5	Judge 6	Judge 7	Referee

Name _____

Signature _____

Lion Cup 2024 Luxembourg

297 Rue de Reckenthal L-2410 Strassen, LUXEMBOURG

Court Nr.	1	Pool	1	Date	2024-06-08	Field Position	61	
RED				BLUE				
NOC	AURLIE ANTOINE (BEL)			NOC	MANSOUR DOUNYA (BEL)			
Category	Kumite Female U18 -59kg							
3 Points	2 Points	1 Point	Score	1 Point	2 Points	3 Points		
			8 : 0					
Penatlity				Penatlity				
C1: , C2:				8:0	C1: C1, C2:			
WINNER				Total				

Decision of Superiority

Judge 1	Judge 2	Judge 3	Judge 4	Judge 5	Judge 6	Judge 7	Referee

Name _____

Signature _____

Lion Cup 2024 Luxembourg

297 Rue de Reckenthal L-2410 Strassen, LUXEMBOURG

Court Nr.	1	Pool	1	Date	2024-06-08	Field Position	62	
RED				BLUE				
NOC	PICAZO LUQUE ELEONORE (FRA)			NOC	MAATOUG NARGESSE (BEL)			
Category	Kumite Female U18 -59kg							
3 Points	2 Points	1 Point	Score	1 Point	2 Points	3 Points		
			0 : 0					
Penatlity				Penatlity				
C1: HC, C2:				0:0	C1: C1, C2:			
WINNER				Total				

Decision of Superiority

Judge 1	Judge 2	Judge 3	Judge 4	Judge 5	Judge 6	Judge 7	Referee

Name _____

Signature _____

Lion Cup 2024 Luxembourg

297 Rue de Reckenthal L-2410 Strassen, LUXEMBOURG

Court Nr.	1	Pool	1	Date	2024-06-08	Field Position	63
RED				BLUE			
NOC	AURLIE ANTOINE (BEL)			NOC	PICAZO LUQUE ELEONORE (FRA)		
Category	Kumite Female U18 -59kg						
3 Points	2 Points	1 Point	Score	1 Point	2 Points	3 Points	
			0 : 1				
Penatlity				Penatlity			
C1: , C2:				0:1	C1: C1, C2:		
				Total	WINNER		

Decision of Superiority

Judge 1	Judge 2	Judge 3	Judge 4	Judge 5	Judge 6	Judge 7	Referee

Name _____

Signature _____

Lion Cup 2024 Luxembourg

297 Rue de Reckenthal L-2410 Strassen, LUXEMBOURG

Court Nr.	1	Pool	1	Date	2024-06-08	Field Position	0	
RED				BLUE				
NOC	LEHNER LEONIE (AUT)			NOC	MANSOUR DOUNYA (BEL)			
Category	Kumite Female U18 -59kg							
3 Points	2 Points	1 Point	Score	1 Point	2 Points	3 Points		
			3 : 6					
Penatlity				Penatlity				
C1: C3, C2:				3:6	C1: C3, C2:			
				Total	WINNER			

Decision of Superiority

Judge 1	Judge 2	Judge 3	Judge 4	Judge 5	Judge 6	Judge 7	Referee

Name _____

Signature _____

Lion Cup 2024 Luxembourg

297 Rue de Reckenthal L-2410 Strassen, LUXEMBOURG

Court Nr.	2	Pool	2	Date	2024-06-08	Field Position	0	
RED				BLUE				
NOC	KASHASH NOUR (NED)			NOC	MAATOUG NARGESSE (BEL)			
Category	Kumite Female U18 -59kg							
3 Points	2 Points	1 Point	Score	1 Point	2 Points	3 Points		
			0 : 5					
Penatlity				Penatlity				
C1: , C2:				0:5	C1: , C2:			
				Total	WINNER			

Decision of Superiority

Judge 1	Judge 2	Judge 3	Judge 4	Judge 5	Judge 6	Judge 7	Referee

Name _____

Signature _____

Lion Cup 2024 Luxembourg

297 Rue de Reckenthal L-2410 Strassen, LUXEMBOURG

Court Nr.	2	Pool	2	Date	2024-06-08	Field Position	2
RED				BLUE			
NOC	KASHASH NOUR (NED)			NOC	STREIT KIM LARA (SUI)		
Category	Kumite Female U18 -59kg						
3 Points	2 Points	1 Point	Score	1 Point	2 Points	3 Points	
			:				
Penatlity				Penatlity			
			Total				

Decision of Superiority

Judge 1	Judge 2	Judge 3	Judge 4	Judge 5	Judge 6	Judge 7	Referee

Name _____

Signature _____

Lion Cup 2024 Luxembourg - 2024-06-07

Official Results

Kumite Female U18 -59kg			
1	PICAZO LUQUE ELEONORE		FRA - FRANCE
2	AURÉLIE ANTOINE		BEL - BELGIUM
3	MANSOUR DOUNYA		BEL - BELGIUM
3	MAATOUG NARGESSE		BEL - BELGIUM
5	LEHNER LEONIE		AUT - AUSTRIA
5	KASHASH NOUR		NED - NETHERLANDS
7	STREIT KIM LARA		SUI - SWITZERLAND

KUMITE FEMALE U21 + 68KG

Lion Cup 2024 Luxembourg

ENTRIES BY WEIGHT CATEGORY
Kumite Female U21 + 68kg

As of 8 JUN 2024

NOC Code	Gender	Name	Seeding
NED	F	Telles Jenna	
NED	F	van Wezel Robin	
POL	F	Nykolyn Yuliia	
SUI	F	Bonny Shaniia	
SUI	F	Rose Nolet Lily	

Kumite Female U21 + 68kg - Round Robin (each against each)

Lion Cup 2024 Luxembourg, 297 Rue de Reckenthal L-2410 Strassen, LUX

2024-06-08

Tatami
3 08:30

Pool
1 / 1

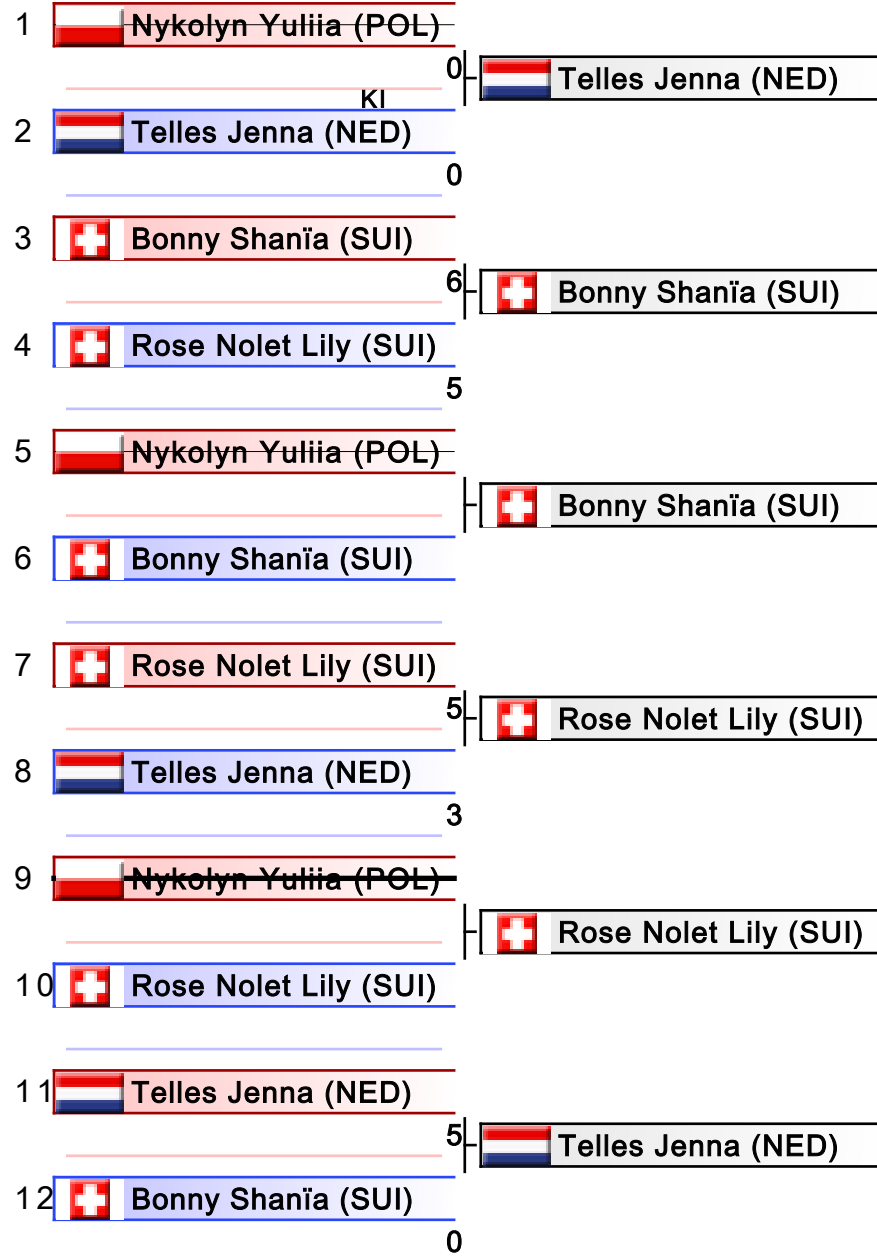

1. ROSE NOLET LILY (SUI)
2. TELLES JENNA (NED)
3. BONNY SHANIĀ (SUI)

Lion Cup 2024 Luxembourg

297 Rue de Reckenthal L-2410 Strassen, LUXEMBOURG

Court Nr.	1	Pool	1	Date	2024-06-08	Field Position	-9967	
RED				BLUE				
NOC	BONNY SHANA (SUI)			NOC	ROSE NOLET LILY (SUI)			
Category	Kumite Female U21 + 68kg							
3 Points	2 Points	1 Point	Score	1 Point	2 Points	3 Points		
			6 : 5					
Penatlity				Penatlity				
C1: C3, C2:				6:5	C1: , C2:			
WINNER				Total				

Decision of Superiority

Judge 1	Judge 2	Judge 3	Judge 4	Judge 5	Judge 6	Judge 7	Referee

Name _____

Signature _____

Lion Cup 2024 Luxembourg

297 Rue de Reckenthal L-2410 Strassen, LUXEMBOURG

Court Nr.	1	Pool	1	Date	2024-06-08	Field Position	-9965
RED				BLUE			
NOC	ROSE NOLET LILY (SUI)			NOC	TELLES JENNA (NED)		
Category	Kumite Female U21 + 68kg						
3 Points	2 Points	1 Point	Score	1 Point	2 Points	3 Points	
			5 : 3				
Penatlity				Penatlity			
C1: HC, C2:				5:3	C1: , C2:		
WINNER				Total			

Decision of Superiority

Judge 1	Judge 2	Judge 3	Judge 4	Judge 5	Judge 6	Judge 7	Referee

Name _____

Signature _____

Lion Cup 2024 Luxembourg

297 Rue de Reckenthal L-2410 Strassen, LUXEMBOURG

Court Nr.	1	Pool	1	Date	2024-06-08	Field Position	-9963
RED				BLUE			
NOC	TELLES JENNA (NED)			NOC	BONNY SHANA (SUI)		
Category	Kumite Female U21 + 68kg						
3 Points	2 Points	1 Point	Score	1 Point	2 Points	3 Points	
			5 : 0				
Penatlity				Penatlity			
C1: C1, C2:				5:0	C1: , C2:		
WINNER				Total			

Decision of Superiority

Judge 1	Judge 2	Judge 3	Judge 4	Judge 5	Judge 6	Judge 7	Referee

Name _____

Signature _____

Lion Cup 2024 Luxembourg

297 Rue de Reckenthal L-2410 Strassen, LUXEMBOURG

Court Nr.	1	Pool	1	Date	2024-06-08	Field Position	-9960
RED				BLUE			
NOC	TELLES JENNA (NED)			NOC	BONNY SHANA (SUI)		
Category	Kumite Female U21 + 68kg						
3 Points	2 Points	1 Point	Score	1 Point	2 Points	3 Points	
			:				
Penatlity				Penatlity			
			Total				

Decision of Superiority

Judge 1	Judge 2	Judge 3	Judge 4	Judge 5	Judge 6	Judge 7	Referee

Name _____

Signature _____

Lion Cup 2024 Luxembourg

297 Rue de Reckenthal L-2410 Strassen, LUXEMBOURG

Court Nr.	1	Pool	1	Date	2024-06-08	Field Position	-9959
RED				BLUE			
NOC	BONNY SHANA (SUI)			NOC	ROSE NOLET LILY (SUI)		
Category	Kumite Female U21 + 68kg						
3 Points	2 Points	1 Point	Score	1 Point	2 Points	3 Points	
			:				
Penatlity				Penatlity			
			Total				

Decision of Superiority

Judge 1	Judge 2	Judge 3	Judge 4	Judge 5	Judge 6	Judge 7	Referee

Name _____

Signature _____

Lion Cup 2024 Luxembourg

297 Rue de Reckenthal L-2410 Strassen, LUXEMBOURG

Court Nr.	1	Pool	1	Date	2024-06-08	Field Position	-9958
RED				BLUE			
NOC	ROSE NOLET LILY (SUI)			NOC	TELLES JENNA (NED)		
Category	Kumite Female U21 + 68kg						
3 Points	2 Points	1 Point	Score	1 Point	2 Points	3 Points	
			:				
Penatlity				Penatlity			
			Total				

Decision of Superiority



Judge 1	Judge 2	Judge 3	Judge 4	Judge 5	Judge 6	Judge 7	Referee

Name _____

Signature _____

Lion Cup 2024 Luxembourg - 2024-06-07

Official Results

Kumite Female U21 + 68kg			
1	ROSE NOLET LILY		SUI - SWITZERLAND
2	TELLES JENNA		NED - NETHERLANDS
3	BONNY SHANIÁ		SUI - SWITZERLAND

KUMITE FEMALE U21 - 50KG

Lion Cup 2024 Luxembourg

ENTRIES BY WEIGHT CATEGORY
Kumite Female U21 - 50kg

As of 8 JUN 2024

NOC Code	Gender	Name	Seeding
BEL	F	Guinotte Shona	
BEL	F	Pauwels Victoria	
FRA	F	Bas Loussine	
LUX	F	Bezruk Olha	
LUX	F	Moens Alix	
NED	F	Yalçin Samina	
SUI	F	Boutracit Aïcha	
SUI	F	Huber Lea	

Kumite Female U21 - 50kg

Lion Cup 2024 Luxembourg, 297 Rue de Reckenthal L-2410 Strassen, LUX

2024-06-08

Tatami
4 08:30

Pool
1 / 1

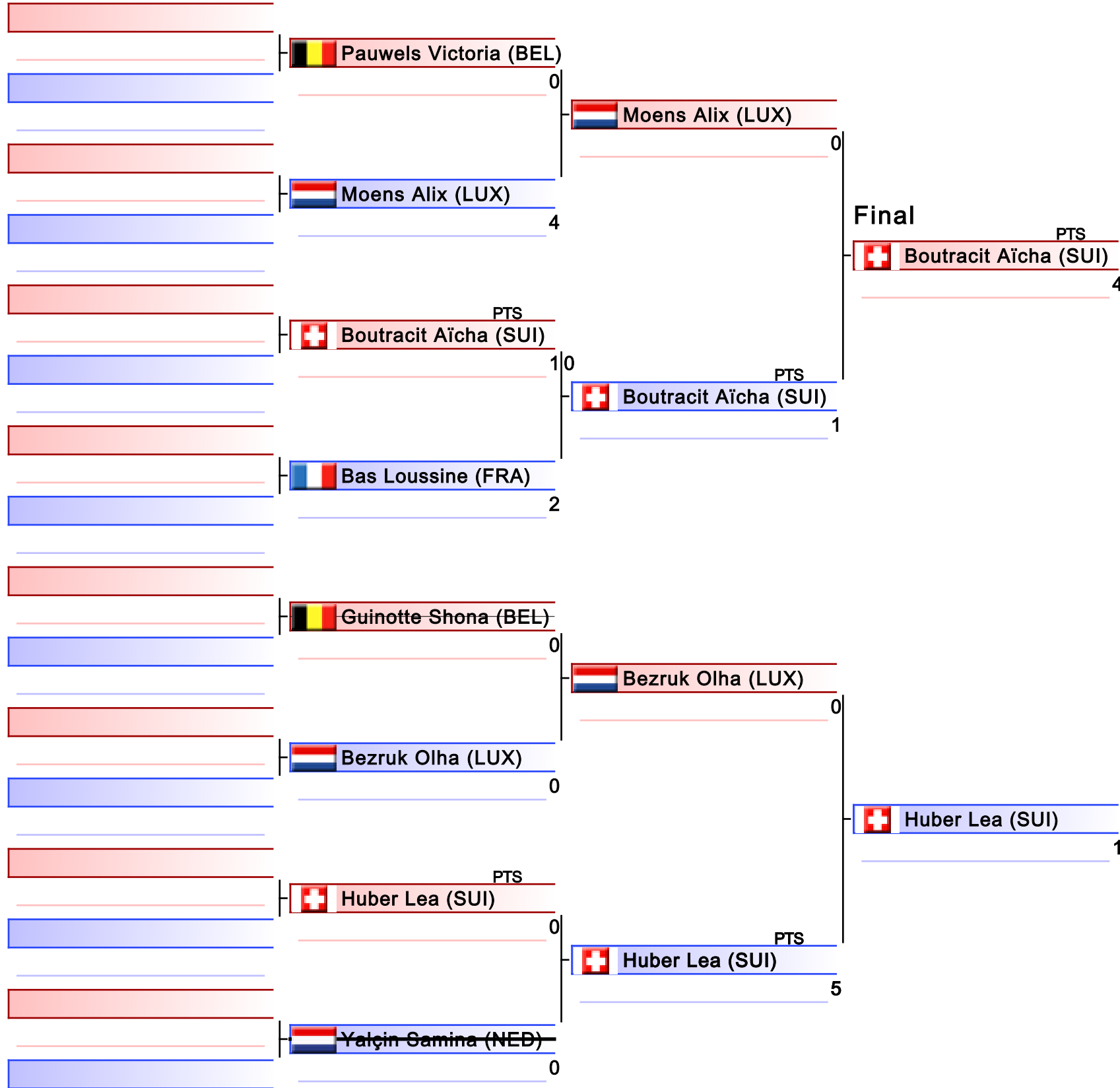

Boutracit Aïcha (SUI)

1. BOUTRACIT AÏCHA (SUI)
2. HUBER LEA (SUI)
3. BEZRUK OLHA (LUX)
3. MOENS ALIX (LUX)
5. BAS LOUSSINE (FRA)

Kumite Female U21 - 50kg

Lion Cup 2024 Luxembourg

2024-06-08

Tatami
4 08:55

Pool
1

(c)sportdata GmbH & Co KG 2000-2024 (2024-06-08 18:41) v 10.1.0 build 1 (2024-01-24 23:23 CET) License: Online_Event_ID-7672_LionCup2024Luxembourg (expire 2024-06-21)

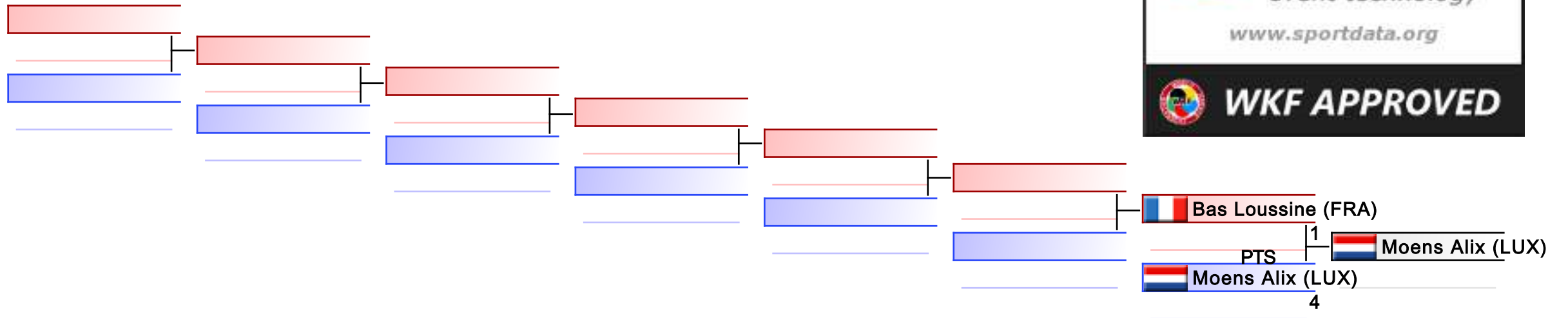

REPECHAGE: (1)

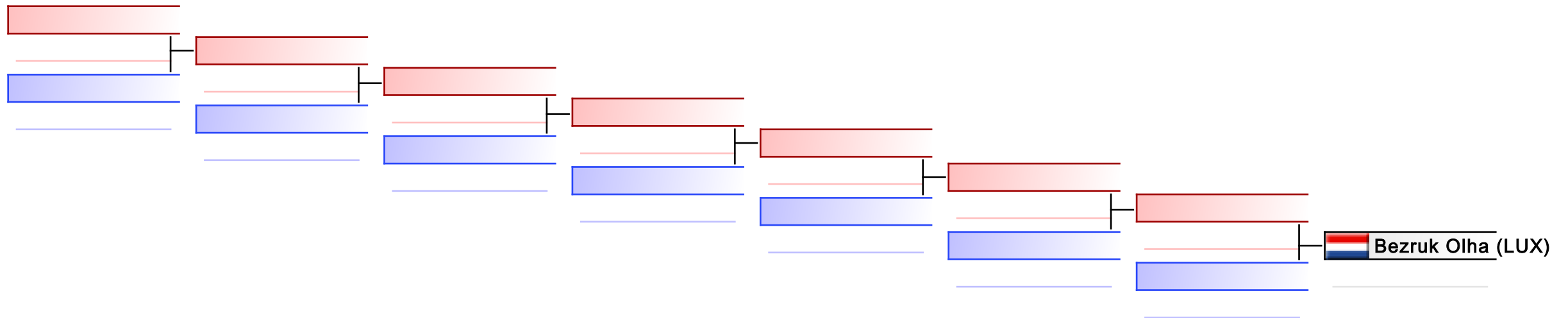

Lion Cup 2024 Luxembourg

297 Rue de Reckenthal L-2410 Strassen, LUXEMBOURG

Court Nr.	1	Pool	1	Date	2024-06-08	Field Position	57
RED				BLUE			
NOC	PAUWELS VICTORIA (BEL)			NOC	MOENS ALIX (LUX)		
Category	Kumite Female U21 - 50kg						
3 Points	2 Points	1 Point	Score	1 Point	2 Points	3 Points	
			0 : 4				
Penatlity				Penatlity			
C1: , C2:			0:4	C1: C1, C2:			
			Total	WINNER			

Decision of Superiority

Judge 1	Judge 2	Judge 3	Judge 4	Judge 5	Judge 6	Judge 7	Referee

Name _____

Signature _____

Lion Cup 2024 Luxembourg

297 Rue de Reckenthal L-2410 Strassen, LUXEMBOURG

Court Nr.	1	Pool	1	Date	2024-06-08	Field Position	58
RED				BLUE			
NOC	BOUTRACIT ACHA (SUI)			NOC	BAS LOUSSINE (FRA)		
Category	Kumite Female U21 - 50kg						
3 Points	2 Points	1 Point	Score	1 Point	2 Points	3 Points	
			10 : 2				
Penatlity				Penatlity			
C1: , C2:			10:2	C1: , C2:			
WINNER			Total				

PTS

Decision of Superiority

Judge 1	Judge 2	Judge 3	Judge 4	Judge 5	Judge 6	Judge 7	Referee

Name _____

Signature _____

Lion Cup 2024 Luxembourg

297 Rue de Reckenthal L-2410 Strassen, LUXEMBOURG

Court Nr.	1	Pool	1	Date	2024-06-08	Field Position	61	
RED				BLUE				
NOC	MOENS ALIX (LUX)			NOC	BOUTRACIT ACHA (SUI)			
Category	Kumite Female U21 - 50kg							
3 Points	2 Points	1 Point	Score	1 Point	2 Points	3 Points		
			0 : 1					
Penatlity				Penatlity				
C1: C2, C2:				0:1	C1: C1, C2:			
				Total	WINNER			

PTS

Decision of Superiority

Judge 1	Judge 2	Judge 3	Judge 4	Judge 5	Judge 6	Judge 7	Referee

Name _____

Signature _____

Lion Cup 2024 Luxembourg

297 Rue de Reckenthal L-2410 Strassen, LUXEMBOURG

Court Nr.	1	Pool	1	Date	2024-06-08	Field Position	62
RED				BLUE			
NOC	BEZRUK OLHA (LUX)			NOC	HUBER LEA (SUI)		
Category	Kumite Female U21 - 50kg						
3 Points	2 Points	1 Point	Score	1 Point	2 Points	3 Points	
			0 : 5				
Penatlity				Penatlity			
C1: C2, C2:			0:5	C1: C1, C2:			
			Total	WINNER			

PTS

Decision of Superiority

Judge 1	Judge 2	Judge 3	Judge 4	Judge 5	Judge 6	Judge 7	Referee

Name _____

Signature _____

Lion Cup 2024 Luxembourg

297 Rue de Reckenthal L-2410 Strassen, LUXEMBOURG

Court Nr.	1	Pool	1	Date	2024-06-08	Field Position	63
RED				BLUE			
NOC	BOUTRACIT ACHA (SUI)			NOC	HUBER LEA (SUI)		
Category	Kumite Female U21 - 50kg						
3 Points	2 Points	1 Point	Score	1 Point	2 Points	3 Points	
			4 : 1				
Penatlity					Penatlity		
C1: HC, C2:				4:1	C1: C3, C2:		
WINNER				Total			

PTS

Decision of Superiority

Judge 1	Judge 2	Judge 3	Judge 4	Judge 5	Judge 6	Judge 7	Referee

Name _____

Signature _____

Lion Cup 2024 Luxembourg

297 Rue de Reckenthal L-2410 Strassen, LUXEMBOURG

Court Nr.	1	Pool	1	Date	2024-06-08	Field Position	0
RED				BLUE			
NOC	BAS LOUSSINE (FRA)			NOC	MOENS ALIX (LUX)		
Category	Kumite Female U21 - 50kg						
3 Points	2 Points	1 Point	Score	1 Point	2 Points	3 Points	
			:				
Penatlity				Penatlity			
			Total				





Decision of Superiority

Judge 1	Judge 2	Judge 3	Judge 4	Judge 5	Judge 6	Judge 7	Referee

Name _____

Signature _____

Official Results

Kumite Female U21 - 50kg			
1	BOUTRACIT AÏCHA		SUI - SWITZERLAND
2	HUBER LEA		SUI - SWITZERLAND
3	BEZRUK OLHA		LUX - LUXEMBOURG
3	MOENS ALIX		LUX - LUXEMBOURG
5	BAS LOUSSINE		FRA - FRANCE

KUMITE FEMALE U21 - 55KG

Lion Cup 2024 Luxembourg

ENTRIES BY WEIGHT CATEGORY
Kumite Female U21 - 55kg

As of 8 JUN 2024

NOC Code	Gender	Name	Seeding
BEL	F	Ejja Imane	
NED	F	Göktekin Simla	
NED	F	van den Brand Julie	
NOR	F	Rasmussen Maja Knøvl	

Kumite Female U21 - 55kg - Round Robin (each against each)

Lion Cup 2024 Luxembourg, 297 Rue de Reckenthal L-2410 Strassen, LUX

2024-06-08

Tatami
2 08:30

Pool
1 / 1

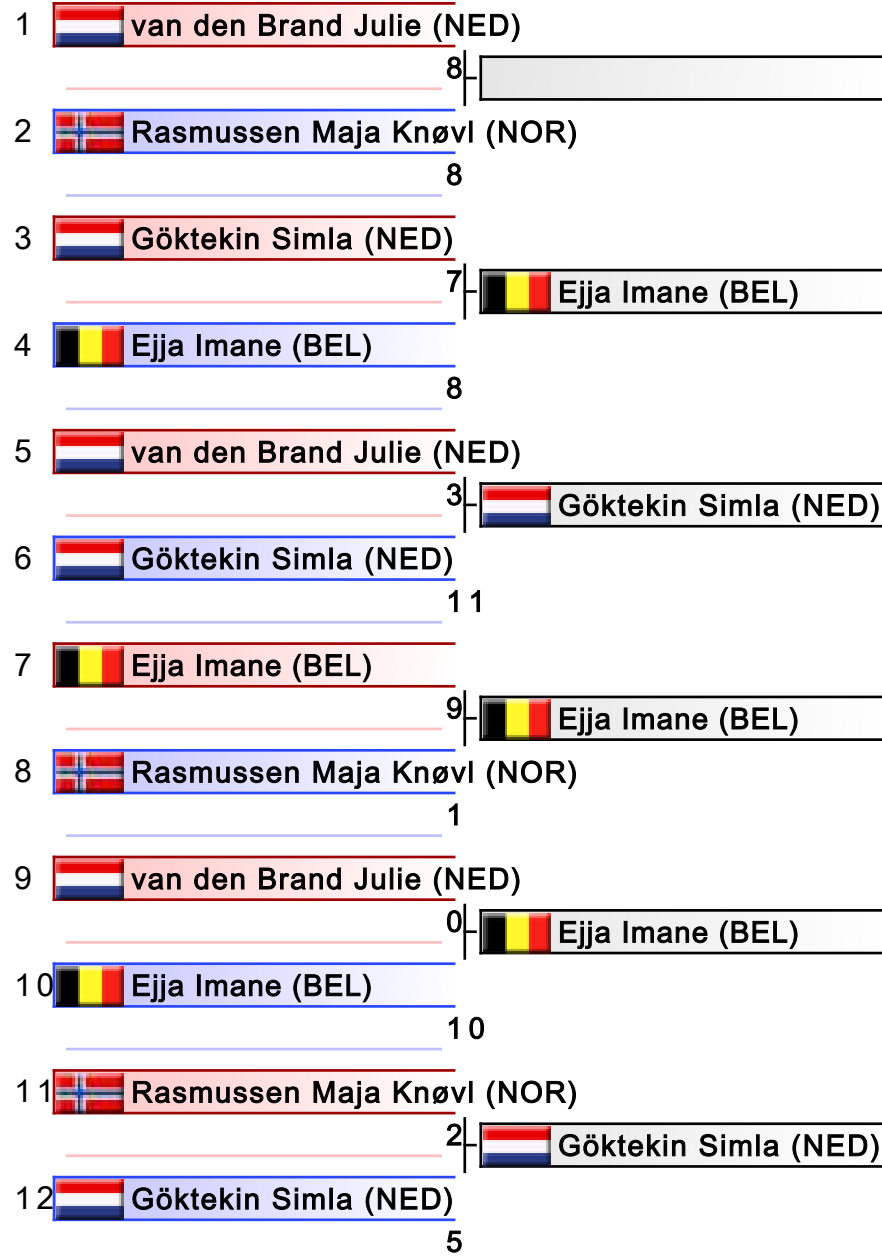

1. EJJA IMANE (BEL)
2. GÖKTEKIN SIMLA (NED)
3. RASMUSSEN MAJA KNØVL (NOR)
3. VAN DEN BRAND JULIE (NED)

Lion Cup 2024 Luxembourg

297 Rue de Reckenthal L-2410 Strassen, LUXEMBOURG

Court Nr.	1	Pool	1	Date	2024-06-08	Field Position	-9951
RED				BLUE			
NOC	VAN DEN BRAND JULIE (NED)			NOC	RASMUSSEN MAJA KNVL (NOR)		
Category	Kumite Female U21 - 55kg						
3 Points	2 Points	1 Point	Score	1 Point	2 Points	3 Points	
			:				
Penatlity				Penatlity			
			8:8				
			Total				

TIE

Decision of Superiority

Judge 1	Judge 2	Judge 3	Judge 4	Judge 5	Judge 6	Judge 7	Referee

Name _____

Signature _____

Lion Cup 2024 Luxembourg

297 Rue de Reckenthal L-2410 Strassen, LUXEMBOURG

Court Nr.	1	Pool	1	Date	2024-06-08	Field Position	-9950
RED				BLUE			
NOC	GKTEKIN SIMLA (NED)			NOC	EJJA IMANE (BEL)		
Category	Kumite Female U21 - 55kg						
3 Points	2 Points	1 Point	Score	1 Point	2 Points	3 Points	
			:				
Penatlity				Penatlity			
			7:8				
			Total	WINNER			

Decision of Superiority

Judge 1	Judge 2	Judge 3	Judge 4	Judge 5	Judge 6	Judge 7	Referee

Name _____

Signature _____

Lion Cup 2024 Luxembourg

297 Rue de Reckenthal L-2410 Strassen, LUXEMBOURG

Court Nr.	1	Pool	1	Date	2024-06-08	Field Position	-9949
RED				BLUE			
NOC	VAN DEN BRAND JULIE (NED)			NOC	GKTEKIN SIMLA (NED)		
Category	Kumite Female U21 - 55kg						
3 Points	2 Points	1 Point	Score	1 Point	2 Points	3 Points	
			:				
Penatlity				Penatlity			
			3:11				
			Total	WINNER			

Decision of Superiority

Judge 1	Judge 2	Judge 3	Judge 4	Judge 5	Judge 6	Judge 7	Referee

Name _____

Signature _____

Lion Cup 2024 Luxembourg

297 Rue de Reckenthal L-2410 Strassen, LUXEMBOURG

Court Nr.	1	Pool	1	Date	2024-06-08	Field Position	-9948
RED				BLUE			
NOC	EJJA IMANE (BEL)			NOC	RASMUSSEN MAJA KNVL (NOR)		
Category	Kumite Female U21 - 55kg						
3 Points	2 Points	1 Point	Score	1 Point	2 Points	3 Points	
			:				
Penatlity				Penatlity			
			9:1				
WINNER			Total				

Decision of Superiority

Judge 1	Judge 2	Judge 3	Judge 4	Judge 5	Judge 6	Judge 7	Referee

Name _____

Signature _____

Lion Cup 2024 Luxembourg

297 Rue de Reckenthal L-2410 Strassen, LUXEMBOURG

Court Nr.	1	Pool	1	Date	2024-06-08	Field Position	-9947
RED				BLUE			
NOC	VAN DEN BRAND JULIE (NED)			NOC	EJJA IMANE (BEL)		
Category	Kumite Female U21 - 55kg						
3 Points	2 Points	1 Point	Score	1 Point	2 Points	3 Points	
			:				
Penatlity				Penatlity			
			0:10				
			Total	WINNER			

Decision of Superiority

Judge 1	Judge 2	Judge 3	Judge 4	Judge 5	Judge 6	Judge 7	Referee

Name _____

Signature _____

Lion Cup 2024 Luxembourg

297 Rue de Reckenthal L-2410 Strassen, LUXEMBOURG

Court Nr.	1	Pool	1	Date	2024-06-08	Field Position	-9946
RED				BLUE			
NOC	RASMUSSEN MAJA KNVL (NOR)			NOC	GKTEKIN SIMLA (NED)		
Category	Kumite Female U21 - 55kg						
3 Points	2 Points	1 Point	Score	1 Point	2 Points	3 Points	
			:				
Penatlity				Penatlity			
			2:5				
			Total	WINNER			

Decision of Superiority

Judge 1	Judge 2	Judge 3	Judge 4	Judge 5	Judge 6	Judge 7	Referee

Name _____

Signature _____

Official Results

Kumite Female U21 - 55kg			
1	EJJA IMANE		BEL - BELGIUM
2	GÖKTEKIN SIMLA		NED - NETHERLANDS
3	RASMUSSEN MAJA KNØVL		NOR - NORWAY
3	VAN DEN BRAND JULIE		NED - NETHERLANDS

KUMITE FEMALE U21 - 61KG

Lion Cup 2024 Luxembourg

ENTRIES BY WEIGHT CATEGORY
Kumite Female U21 - 61kg

As of 8 JUN 2024

NOC Code	Gender	Name	Seeding
BEL	F	Bougrine Amel	
LUX	F	TIZOURINE Lisa	
NED	F	Horsmans Joanna	
NED	F	Kaewborisut Lyana	
NED	F	Kakiay Ashley	
POR	F	Carvalho Lara	
SUI	F	Bosshard Lea Marie	
SUI	F	Burri Liliane	
SUI	F	Wohlgemuth Naiya Elin	

Kumite Female U21 - 61kg

Lion Cup 2024 Luxembourg, 297 Rue de Reckenthal L-2410 Strassen, LUX

2024-06-08

Tatami
5 08:30

Pool
1 / 1

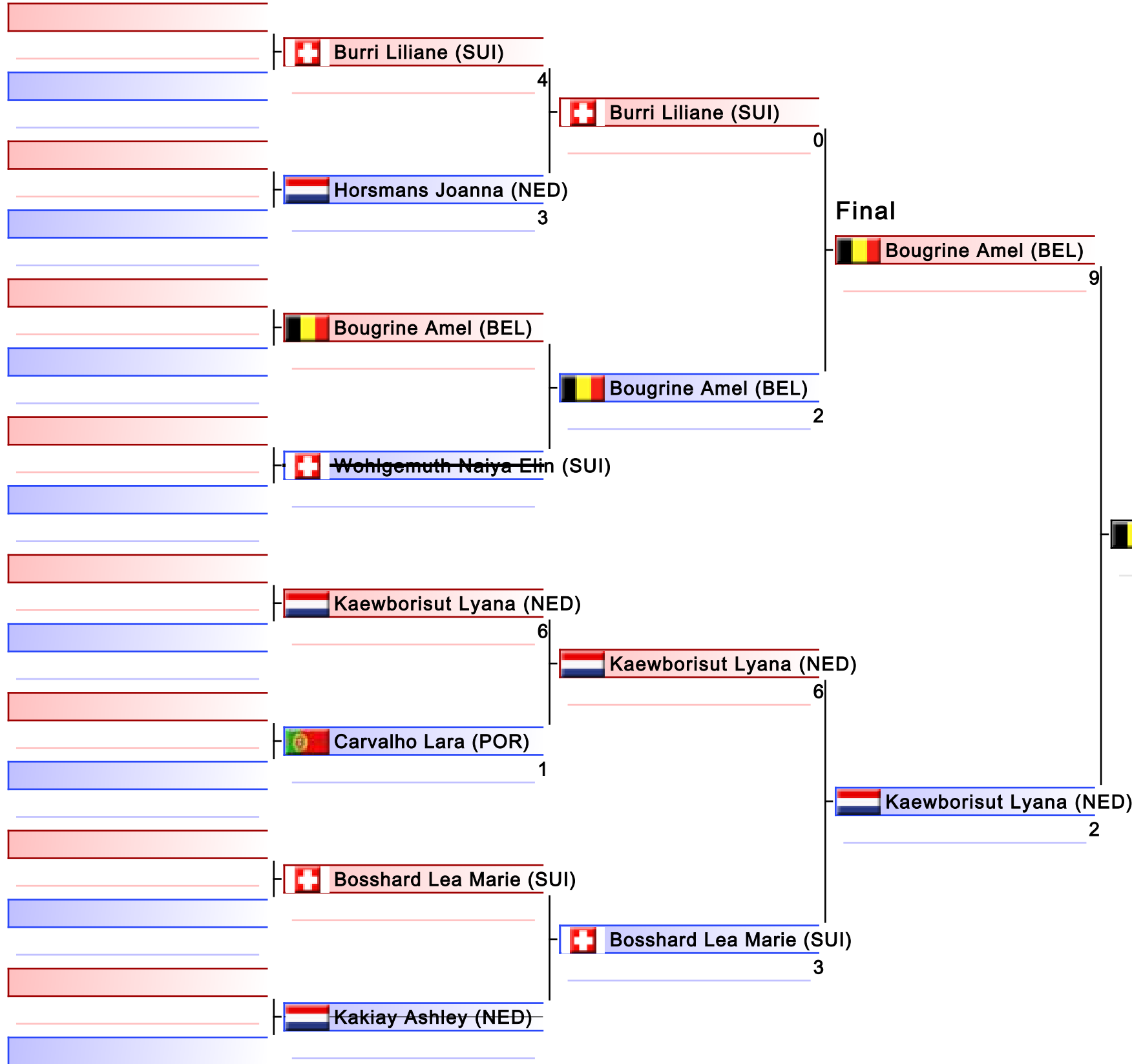

1. BOUGRINE AMEL (BEL)
2. KAEWBORISUT LYANA (NED)
3. BURRI LILIANE (SUI)
3. BOSSHARD LEA MARIE (SUI)
5. CARVALHO LARA (POR)

Kumite Female U21 - 61kg

Lion Cup 2024 Luxembourg

2024-06-08

Tatami
5 09:00

Pool
1

(c)sportdata GmbH & Co KG 2000-2024 (2024-06-08 18:41) v 10.1.0 build 1 (2024-01-24 23:23 CET) License: Online_Event_ID-7672_LionCup2024Luxembourg (expire 2024-06-21)

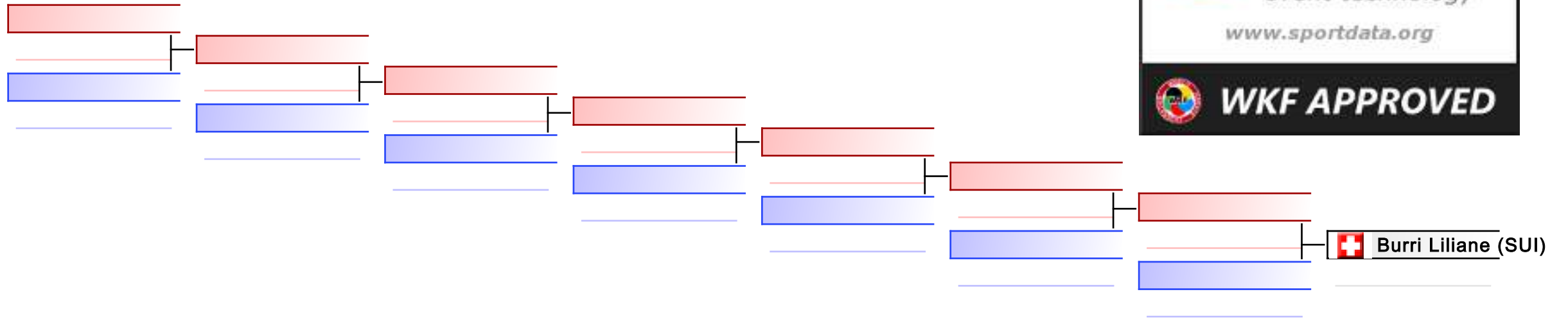

REPECHAGE: (1)

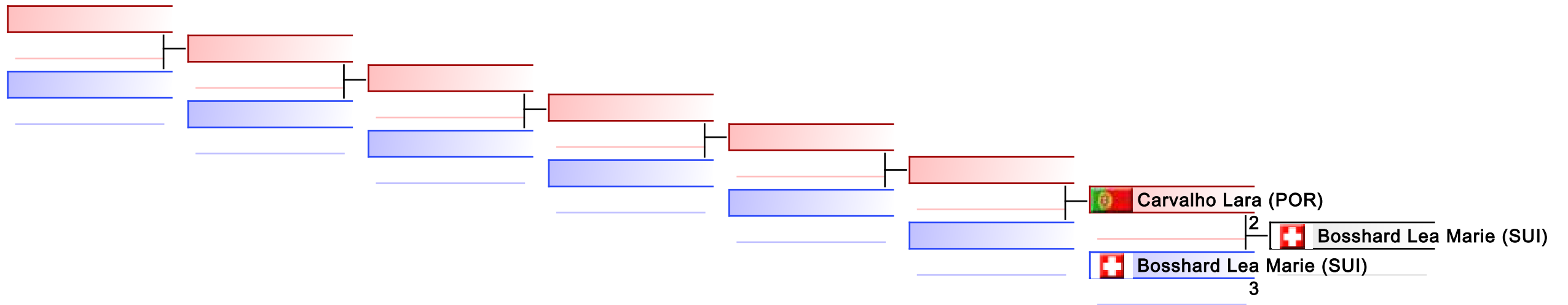

Lion Cup 2024 Luxembourg

297 Rue de Reckenthal L-2410 Strassen, LUXEMBOURG

Court Nr.	1	Pool	1	Date	2024-06-08	Field Position	57
RED				BLUE			
NOC	BURRI LILIANE (SUI)			NOC	HORSMANS JOANNA (NED)		
Category	Kumite Female U21 - 61kg						
3 Points	2 Points	1 Point	Score	1 Point	2 Points	3 Points	
			4 : 3				
Penatlity				Penatlity			
C1: C3, C2:			4:3	C1: C2, C2:			
WINNER			Total				

Decision of Superiority

Judge 1	Judge 2	Judge 3	Judge 4	Judge 5	Judge 6	Judge 7	Referee

Name _____

Signature _____

Lion Cup 2024 Luxembourg

297 Rue de Reckenthal L-2410 Strassen, LUXEMBOURG

Court Nr.	1	Pool	1	Date	2024-06-08	Field Position	59	
RED				BLUE				
NOC	KAEWBORISUT LYANA (NED)			NOC	CARVALHO LARA (POR)			
Category	Kumite Female U21 - 61kg							
3 Points	2 Points	1 Point	Score	1 Point	2 Points	3 Points		
			6 : 1					
Penatlity				Penatlity				
C1: HC, C2:				6:1	C1: , C2:			
WINNER				Total				

Decision of Superiority

Judge 1	Judge 2	Judge 3	Judge 4	Judge 5	Judge 6	Judge 7	Referee

Name _____

Signature _____

Lion Cup 2024 Luxembourg

297 Rue de Reckenthal L-2410 Strassen, LUXEMBOURG

Court Nr.	1	Pool	1	Date	2024-06-08	Field Position	61
RED				BLUE			
NOC	BURRI LILIANE (SUI)			NOC	BOUGRINE AMEL (BEL)		
Category	Kumite Female U21 - 61kg						
3 Points	2 Points	1 Point	Score	1 Point	2 Points	3 Points	
			0 : 2				
Penatlity				Penatlity			
C1: , C2:			0:2	C1: HC, C2:			
			Total	WINNER			

Decision of Superiority

Judge 1	Judge 2	Judge 3	Judge 4	Judge 5	Judge 6	Judge 7	Referee

Name _____

Signature _____

Lion Cup 2024 Luxembourg

297 Rue de Reckenthal L-2410 Strassen, LUXEMBOURG

Court Nr.	1	Pool	1	Date	2024-06-08	Field Position	62	
RED				BLUE				
NOC	KAEWBORISUT LYANA (NED)			NOC	BOSSHARD LEA MARIE (SUI)			
Category	Kumite Female U21 - 61kg							
3 Points	2 Points	1 Point	Score	1 Point	2 Points	3 Points		
			6 : 3					
Penatlity				Penatlity				
C1: HC, C2:				6:3	C1: , C2:			
WINNER				Total				

Decision of Superiority

Judge 1	Judge 2	Judge 3	Judge 4	Judge 5	Judge 6	Judge 7	Referee

Name _____

Signature _____

Lion Cup 2024 Luxembourg

297 Rue de Reckenthal L-2410 Strassen, LUXEMBOURG

Court Nr.	1	Pool	1	Date	2024-06-08	Field Position	63
RED				BLUE			
NOC	BOUGRINE AMEL (BEL)			NOC	KAEWBORISUT LYANA (NED)		
Category	Kumite Female U21 - 61kg						
3 Points	2 Points	1 Point	Score	1 Point	2 Points	3 Points	
			9 : 2				
Penatlity				Penatlity			
C1: C3, C2:			9:2	C1: C1, C2:			
WINNER			Total				

Decision of Superiority

Judge 1	Judge 2	Judge 3	Judge 4	Judge 5	Judge 6	Judge 7	Referee

Name _____

Signature _____

Lion Cup 2024 Luxembourg

297 Rue de Reckenthal L-2410 Strassen, LUXEMBOURG

Court Nr.	2	Pool	2	Date	2024-06-08	Field Position	0
RED				BLUE			
NOC	CARVALHO LARA (POR)			NOC	BOSSHARD LEA MARIE (SUI)		
Category	Kumite Female U21 - 61kg						
3 Points	2 Points	1 Point	Score	1 Point	2 Points	3 Points	
			:				
Penatlity				Penatlity			
			Total				

Decision of Superiority

Judge 1	Judge 2	Judge 3	Judge 4	Judge 5	Judge 6	Judge 7	Referee

Name _____

Signature _____

Official Results

Kumite Female U21 - 61kg			
1	BOUGRINE AMEL		BEL - BELGIUM
2	KAEWBORISUT LYANA		NED - NETHERLANDS
3	BURRI LILIANE		SUI - SWITZERLAND
3	BOSSHARD LEA MARIE		SUI - SWITZERLAND
5	CARVALHO LARA		POR - PORTUGAL

KUMITE FEMALE U21 - 68KG

Lion Cup 2024 Luxembourg

ENTRIES BY WEIGHT CATEGORY
Kumite Female U21 - 68kg

As of 8 JUN 2024

NOC Code	Gender	Name	Seeding
BEL	F	Bougrine Amina	
BEL	F	Vervoort Tess	
NED	F	Mamadeus Sennah	
NED	F	Suurmond Zoë	







Kumite Female U21 - 68kg - Round Robin (each against each)

Lion Cup 2024 Luxembourg, 297 Rue de Reckenthal L-2410 Strassen, LUX

2024-06-08

Tatami
1 08:30

Pool
1 / 1

1	 Mamadeus Sennah (NED)	2	 Vervoort Tess (BEL)
	PTS		
2	 Vervoort Tess (BEL)	7	
3	 Suurmond Zoë (NED)	0	 Bougrine Amina (BEL)
	PTS		
4	 Bougrine Amina (BEL)	9	
	PTS		
5	 Mamadeus Sennah (NED)	6	 Mamadeus Sennah (NED)
6	 Suurmond Zoë (NED)	0	
7	 Bougrine Amina (BEL)	0	 Vervoort Tess (BEL)
	PTS		
8	 Vervoort Tess (BEL)	6	
	PTS		
9	 Mamadeus Sennah (NED)	2	 Mamadeus Sennah (NED)
10	 Bougrine Amina (BEL)	0	
	PTS		
11	 Vervoort Tess (BEL)	3	 Vervoort Tess (BEL)
12	 Suurmond Zoë (NED)	0	



1. VERVOORT TESS (BEL)
2. MAMADEUS SENNAH (NED)
3. BOUGRINE AMINA (BEL)
3. SUURMOND ZOË (NED)

Lion Cup 2024 Luxembourg

297 Rue de Reckenthal L-2410 Strassen, LUXEMBOURG

Court Nr.	1	Pool	1	Date	2024-06-08	Field Position	-9951	
RED				BLUE				
NOC	MAMADEUS SENNAH (NED)			NOC	VERVOORT TESS (BEL)			
Category	Kumite Female U21 - 68kg							
3 Points	2 Points	1 Point	Score	1 Point	2 Points	3 Points		
			2 : 7					
Penatlity				Penatlity				
C1: C1, C2:				2:7	C1: C1, C2:			
				Total	WINNER			

PTS

Decision of Superiority

Judge 1	Judge 2	Judge 3	Judge 4	Judge 5	Judge 6	Judge 7	Referee

Name _____

Signature _____

Lion Cup 2024 Luxembourg

297 Rue de Reckenthal L-2410 Strassen, LUXEMBOURG

Court Nr.	1	Pool	1	Date	2024-06-08	Field Position	-9950
RED				BLUE			
NOC	SUURMOND ZO (NED)			NOC	BOUGRINE AMINA (BEL)		
Category	Kumite Female U21 - 68kg						
3 Points	2 Points	1 Point	Score	1 Point	2 Points	3 Points	
			0 : 9				
Penatlity				Penatlity			
C1: , C2:			0:9	C1: C1, C2:			
			Total	WINNER			

PTS

Decision of Superiority

Judge 1	Judge 2	Judge 3	Judge 4	Judge 5	Judge 6	Judge 7	Referee

Name _____

Signature _____

Lion Cup 2024 Luxembourg

297 Rue de Reckenthal L-2410 Strassen, LUXEMBOURG

Court Nr.	1	Pool	1	Date	2024-06-08	Field Position	-9949	
RED				BLUE				
NOC	MAMADEUS SENNAH (NED)			NOC	SUURMOND ZO (NED)			
Category	Kumite Female U21 - 68kg							
3 Points	2 Points	1 Point	Score	1 Point	2 Points	3 Points		
			6 : 0					
Penatlity				Penatlity				
C1: C1, C2:				6:0	C1: C1, C2:			
WINNER				Total				

PTS

Decision of Superiority

Judge 1	Judge 2	Judge 3	Judge 4	Judge 5	Judge 6	Judge 7	Referee

Name _____

Signature _____

Lion Cup 2024 Luxembourg

297 Rue de Reckenthal L-2410 Strassen, LUXEMBOURG

Court Nr.	1	Pool	1	Date	2024-06-08	Field Position	-9948
RED				BLUE			
NOC	BOUGRINE AMINA (BEL)			NOC	VERVOORT TESS (BEL)		
Category	Kumite Female U21 - 68kg						
3 Points	2 Points	1 Point	Score	1 Point	2 Points	3 Points	
			0 : 6				
Penatlity				Penatlity			
C1: C2, C2:			0:6	C1: C1, C2:			
			Total	WINNER			

PTS

Decision of Superiority

Judge 1	Judge 2	Judge 3	Judge 4	Judge 5	Judge 6	Judge 7	Referee

Name _____

Signature _____

Lion Cup 2024 Luxembourg

297 Rue de Reckenthal L-2410 Strassen, LUXEMBOURG

Court Nr.	1	Pool	1	Date	2024-06-08	Field Position	-9947	
RED				BLUE				
NOC	MAMADEUS SENNAH (NED)			NOC	BOUGRINE AMINA (BEL)			
Category	Kumite Female U21 - 68kg							
3 Points	2 Points	1 Point	Score	1 Point	2 Points	3 Points		
			2 : 0					
Penatlity				Penatlity				
C1: C3, C2:				2:0	C1: HC, C2:			
WINNER				Total				

PTS

Decision of Superiority

Judge 1	Judge 2	Judge 3	Judge 4	Judge 5	Judge 6	Judge 7	Referee

Name _____

Signature _____

Lion Cup 2024 Luxembourg

297 Rue de Reckenthal L-2410 Strassen, LUXEMBOURG

Court Nr.	1	Pool	1	Date	2024-06-08	Field Position	-9946
RED				BLUE			
NOC	VERVOORT TESS (BEL)			NOC	SUURMOND ZO (NED)		
Category	Kumite Female U21 - 68kg						
3 Points	2 Points	1 Point	Score	1 Point	2 Points	3 Points	
			3 : 0				
Penatlity				Penatlity			
C1: , C2:			3:0	C1: , C2:			
WINNER			Total				

PTS

Decision of Superiority

Judge 1	Judge 2	Judge 3	Judge 4	Judge 5	Judge 6	Judge 7	Referee

Name _____

Signature _____

Official Results

Kumite Female U21 - 68kg			
1	VERVOORT TESS		BEL - BELGIUM
2	MAMADEUS SENNAH		NED - NETHERLANDS
3	BOUGRINE AMINA		BEL - BELGIUM
3	SUURMOND ZOË		NED - NETHERLANDS

KUMITE MALE SENIOR +84KG

Lion Cup 2024 Luxembourg

ENTRIES BY WEIGHT CATEGORY
Kumite Male Senior +84kg

As of 8 JUN 2024

NOC Code	Gender	Name	Seeding
ALG	M	Moudir Adel	
LUX	M	BALA Jetnor	
NED	M	El Feddali Aouab	
NED	M	Kaewborisut Justin	
NED	M	Moerkerk van Joel	
POR	M	Pereira Leonardo	
POR	M	PINTO BRUNO	
SUI	M	Graf Ilias	
SUI	M	Kabashi John	
SUI	M	Rouèche David	
SUI	M	Zecca Donato	

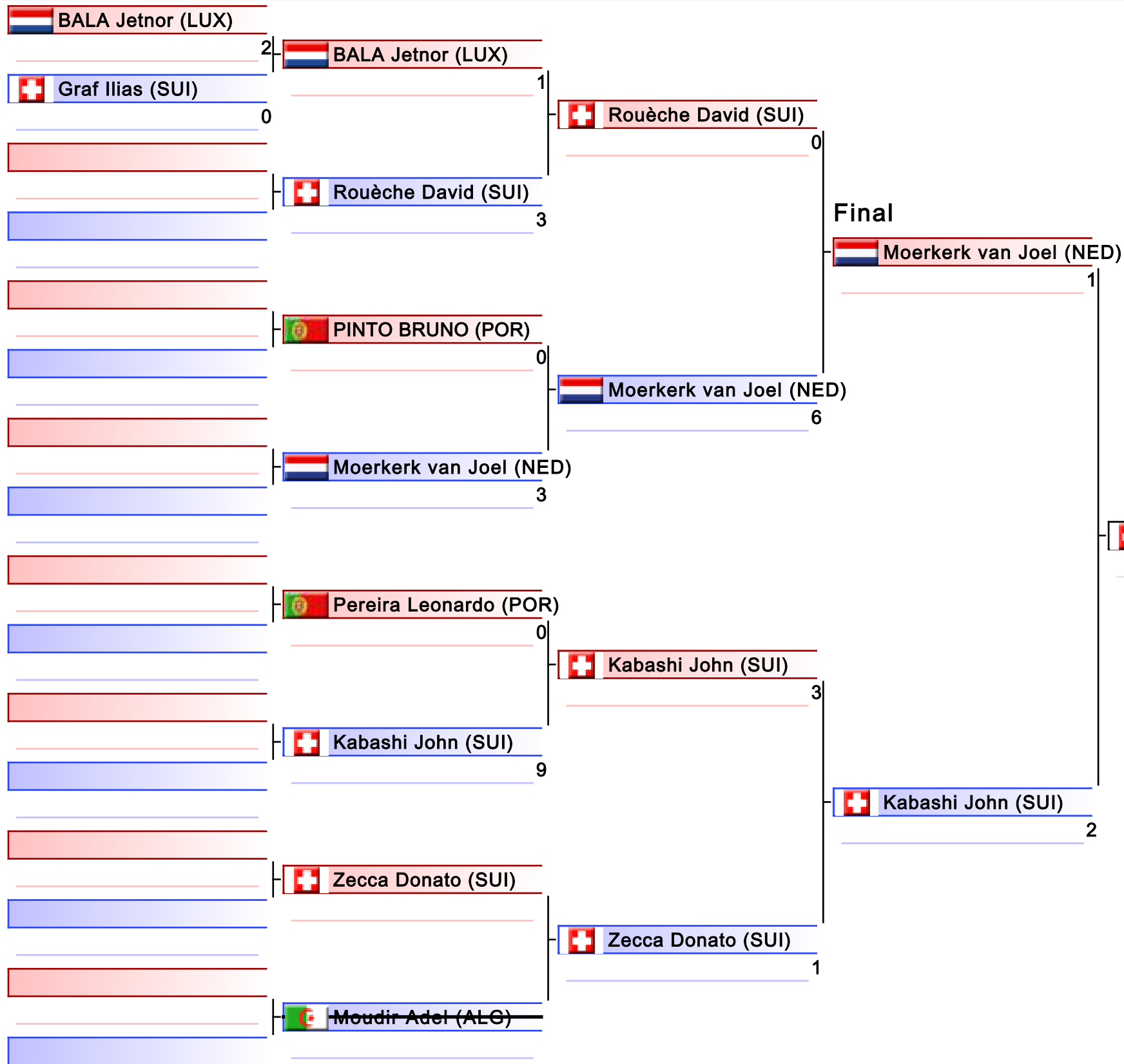

1. KABASHI JOHN (SUI)
2. MOERKERK VAN JOEL (NED)
3. PINTO BRUNO (POR)
3. PEREIRA LEONARDO (POR)
5. ROUÈCHE DAVID (SUI)
5. ZECCA DONATO (SUI)

Kumite Male Senior +84kg

Lion Cup 2024 Luxembourg

2024-06-08

Tatami
6 09:15

Pool
1

(c)sportdata GmbH & Co KG 2000-2024 (2024-06-08 18:41) v 10.1.0 build 1 (2024-01-24 23:23 CET) License: Online_Event_ID-7672_LionCup2024Luxembourg (expire 2024-06-21)

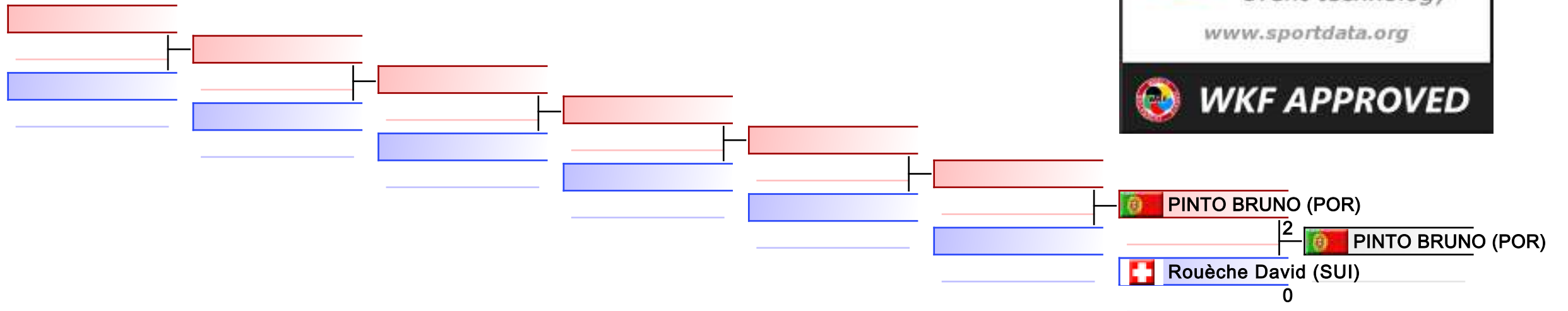

REPECHAGE: (1)

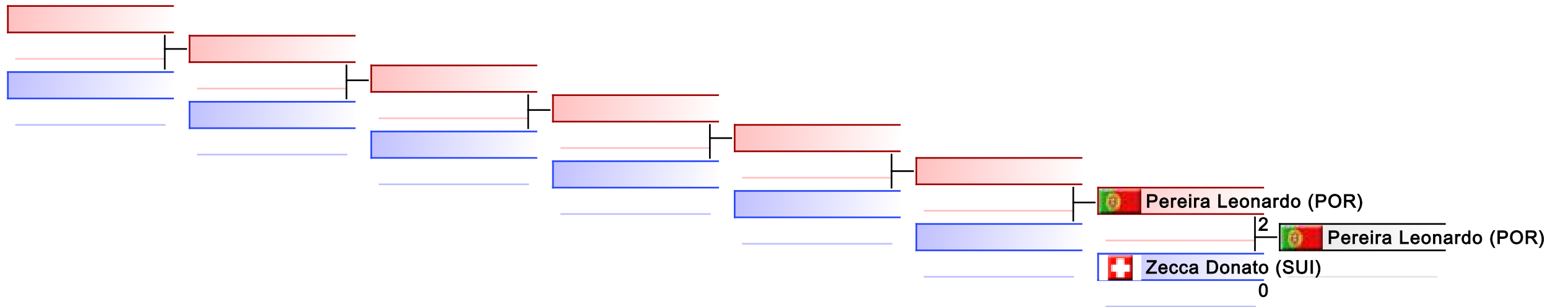

Lion Cup 2024 Luxembourg

297 Rue de Reckenthal L-2410 Strassen, LUXEMBOURG

Court Nr.	1	Pool	1	Date	2024-06-08	Field Position	49
RED				BLUE			
NOC	BALA JETNOR (LUX)			NOC	GRAF ILIAS (SUI)		
Category	Kumite Male Senior +84kg						
3 Points	2 Points	1 Point	Score	1 Point	2 Points	3 Points	
			2 : 0				
Penatlity					Penatlity		
C1: C2, C2:				2:0	C1: C2, C2:		
WINNER				Total			

Decision of Superiority

Judge 1	Judge 2	Judge 3	Judge 4	Judge 5	Judge 6	Judge 7	Referee

Name _____

Signature _____

Lion Cup 2024 Luxembourg

297 Rue de Reckenthal L-2410 Strassen, LUXEMBOURG

Court Nr.	1	Pool	1	Date	2024-06-08	Field Position	57	
RED				BLUE				
NOC	BALA JETNOR (LUX)			NOC	ROUCHE DAVID (SUI)			
Category	Kumite Male Senior +84kg							
3 Points	2 Points	1 Point	Score	1 Point	2 Points	3 Points		
			1 : 3					
Penatlity				Penatlity				
C1: C2, C2:				1:3	C1: HC, C2:			
				Total	WINNER			

Decision of Superiority

Judge 1	Judge 2	Judge 3	Judge 4	Judge 5	Judge 6	Judge 7	Referee

Name _____

Signature _____

Lion Cup 2024 Luxembourg

297 Rue de Reckenthal L-2410 Strassen, LUXEMBOURG

Court Nr.	1	Pool	1	Date	2024-06-08	Field Position	58
RED				BLUE			
NOC	PINTO BRUNO (POR)			NOC	MOERKERK VAN JOEL (NED)		
Category	Kumite Male Senior +84kg						
3 Points	2 Points	1 Point	Score	1 Point	2 Points	3 Points	
			0 : 3				
Penatlity				Penatlity			
C1: C1, C2:			0:3	C1: C2, C2:			
			Total	WINNER			

Decision of Superiority

Judge 1	Judge 2	Judge 3	Judge 4	Judge 5	Judge 6	Judge 7	Referee

Name _____

Signature _____

Lion Cup 2024 Luxembourg

297 Rue de Reckenthal L-2410 Strassen, LUXEMBOURG

Court Nr.	1	Pool	1	Date	2024-06-08	Field Position	59
RED				BLUE			
NOC	PEREIRA LEONARDO (POR)			NOC	KABASHI JOHN (SUI)		
Category	Kumite Male Senior +84kg						
3 Points	2 Points	1 Point	Score	1 Point	2 Points	3 Points	
			0 : 9				
Penatlity					Penatlity		
C1: C1, C2:				0:9	C1: C1, C2:		
				Total	WINNER		

Decision of Superiority

Judge 1	Judge 2	Judge 3	Judge 4	Judge 5	Judge 6	Judge 7	Referee

Name _____

Signature _____

Lion Cup 2024 Luxembourg

297 Rue de Reckenthal L-2410 Strassen, LUXEMBOURG

Court Nr.	1	Pool	1	Date	2024-06-08	Field Position	61	
RED				BLUE				
NOC	ROUCHE DAVID (SUI)			NOC	MOERKERK VAN JOEL (NED)			
Category	Kumite Male Senior +84kg							
3 Points	2 Points	1 Point	Score	1 Point	2 Points	3 Points		
			0 : 6					
Penatlity				Penatlity				
C1: , C2:				0:6	C1: , C2:			
				Total	WINNER			

Decision of Superiority

Judge 1	Judge 2	Judge 3	Judge 4	Judge 5	Judge 6	Judge 7	Referee

Name _____

Signature _____

Lion Cup 2024 Luxembourg

297 Rue de Reckenthal L-2410 Strassen, LUXEMBOURG

Court Nr.	1	Pool	1	Date	2024-06-08	Field Position	62	
RED				BLUE				
NOC	KABASHI JOHN (SUI)			NOC	ZECCA DONATO (SUI)			
Category	Kumite Male Senior +84kg							
3 Points	2 Points	1 Point	Score	1 Point	2 Points	3 Points		
			3 : 1					
Penatlity				Penatlity				
C1: HC, C2:				3:1	C1: C2, C2:			
WINNER				Total				

Decision of Superiority

Judge 1	Judge 2	Judge 3	Judge 4	Judge 5	Judge 6	Judge 7	Referee

Name _____

Signature _____

Lion Cup 2024 Luxembourg

297 Rue de Reckenthal L-2410 Strassen, LUXEMBOURG

Court Nr.	1	Pool	1	Date	2024-06-08	Field Position	63
RED				BLUE			
NOC	MOERKERK VAN JOEL (NED)			NOC	KABASHI JOHN (SUI)		
Category	Kumite Male Senior +84kg						
3 Points	2 Points	1 Point	Score	1 Point	2 Points	3 Points	
			1 : 2				
Penatlity				Penatlity			
C1: , C2:			1:2	C1: HC, C2:			
			Total	WINNER			

Decision of Superiority

Judge 1	Judge 2	Judge 3	Judge 4	Judge 5	Judge 6	Judge 7	Referee

Name _____

Signature _____

Lion Cup 2024 Luxembourg

297 Rue de Reckenthal L-2410 Strassen, LUXEMBOURG

Court Nr.	1	Pool	1	Date	2024-06-08	Field Position	0
RED				BLUE			
NOC	PINTO BRUNO (POR)			NOC	ROUCHE DAVID (SUI)		
Category	Kumite Male Senior +84kg						
3 Points	2 Points	1 Point	Score	1 Point	2 Points	3 Points	
			:				
Penatlity				Penatlity			
			Total				

Decision of Superiority

Judge 1	Judge 2	Judge 3	Judge 4	Judge 5	Judge 6	Judge 7	Referee

Name _____

Signature _____

Lion Cup 2024 Luxembourg

297 Rue de Reckenthal L-2410 Strassen, LUXEMBOURG

Court Nr.	2	Pool	2	Date	2024-06-08	Field Position	0
RED				BLUE			
NOC	PEREIRA LEONARDO (POR)			NOC	ZECCA DONATO (SUI)		
Category	Kumite Male Senior +84kg						
3 Points	2 Points	1 Point	Score	1 Point	2 Points	3 Points	
			2 : 0				
Penatlity				Penatlity			
C1: C1, C2:				2:0	C1: C1, C2:		
WINNER				Total			







Decision of Superiority

Judge 1	Judge 2	Judge 3	Judge 4	Judge 5	Judge 6	Judge 7	Referee

Name _____

Signature _____

Official Results

Kumite Male Senior +84kg			
1	KABASHI JOHN		SUI - SWITZERLAND
2	MOERKERK VAN JOEL		NED - NETHERLANDS
3	PINTO BRUNO		POR - PORTUGAL
3	PEREIRA LEONARDO		POR - PORTUGAL
5	ROUËCHE DAVID		SUI - SWITZERLAND
5	ZECCA DONATO		SUI - SWITZERLAND

KUMITE MALE SENIOR -60KG

Lion Cup 2024 Luxembourg

ENTRIES BY WEIGHT CATEGORY
Kumite Male Senior -60kg

As of 8 JUN 2024

NOC Code	Gender	Name	Seeding
ALG	M	SERHANI ISLEM	
AUT	M	Lang Marcus	
BEL	M	Dasoul Michael	
BEL	M	Gjemajl Ademi	
ESP	M	Lopes Ivan	
FRA	M	PICAZO LUQUE Angel	
LUX	M	Teixeira Tomas	
NOR	M	Hansen Henrik Walstad	
SUI	M	Schmid Samuel	

Kumite Male Senior -60kg

Lion Cup 2024 Luxembourg, 297 Rue de Reckenthal L-2410 Strassen, LUX

2024-06-08

Tatami
1 08:55

Pool
1 / 1

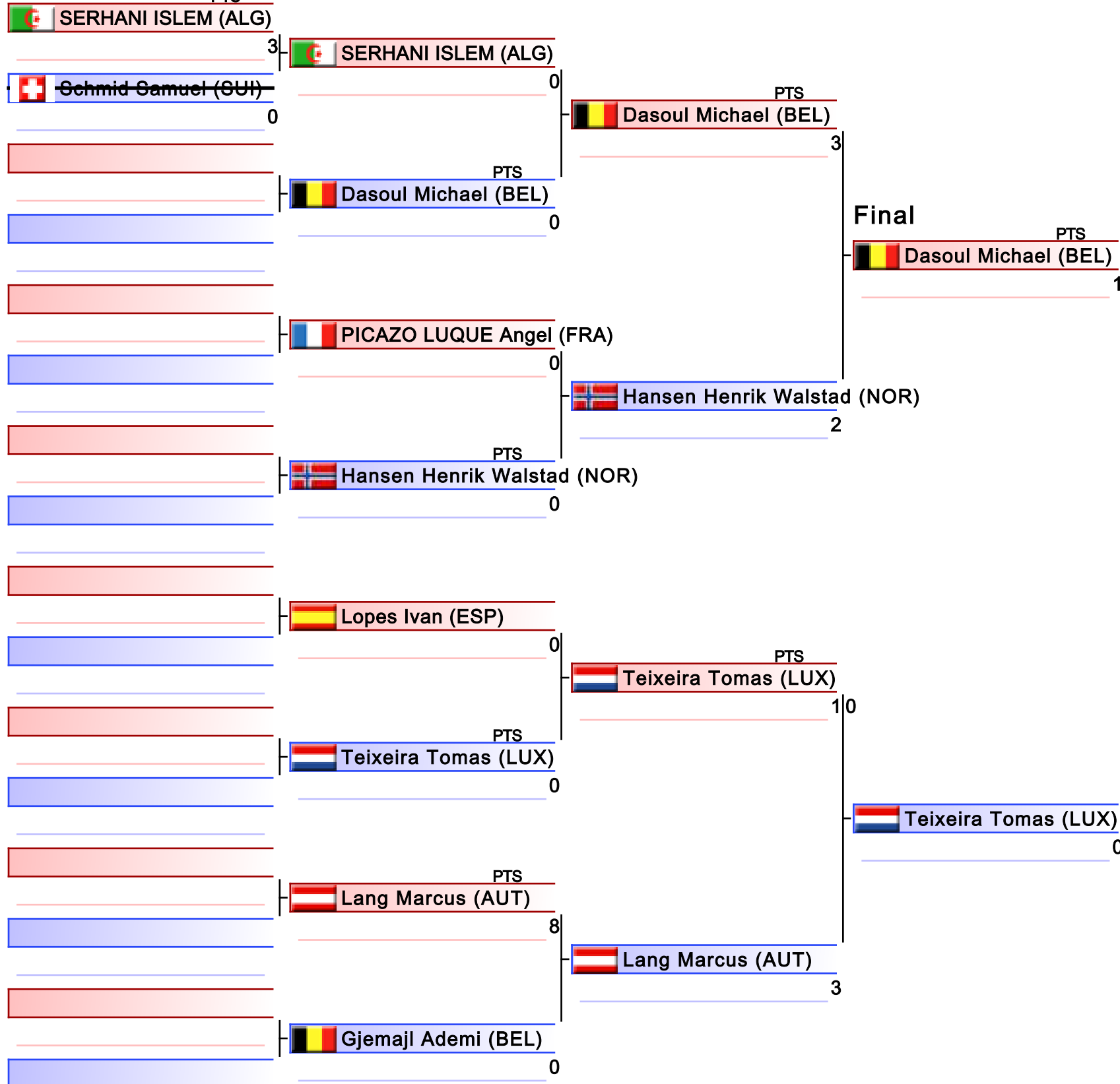

1. DASOUL MICHAEL (BEL)
2. TEIXEIRA TOMAS (LUX)
3. HANSEN HENRIK WALSTAD (NOR)
3. LANG MARCUS (AUT)
5. SERHANI ISLEM (ALG)
5. LOPES IVAN (ESP)

Kumite Male Senior -60kg

Lion Cup 2024 Luxembourg

2024-06-08

Tatami
1 09:30

Pool
1

(c)sportdata GmbH & Co KG 2000-2024 (2024-06-08 18:41) v 10.1.0 build 1 (2024-01-24 23:23 CET) License: Online_Event_ID-7672_LionCup2024Luxembourg (expire 2024-06-21)

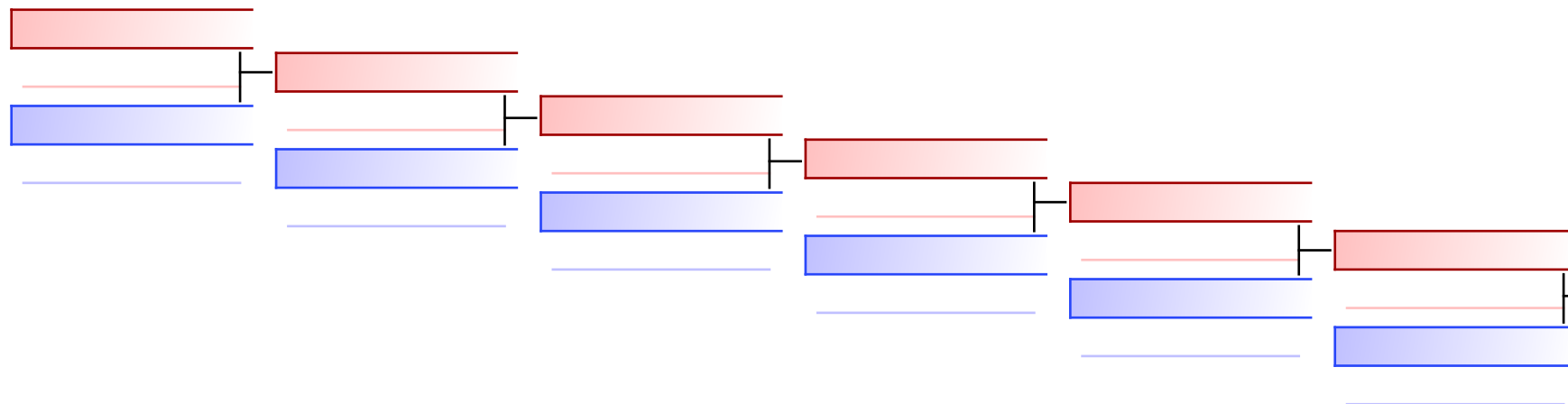

 SERHANI ISLEM (ALG)

 Hansen Henrik Walstad (NOR)

REPECHAGE: (1)

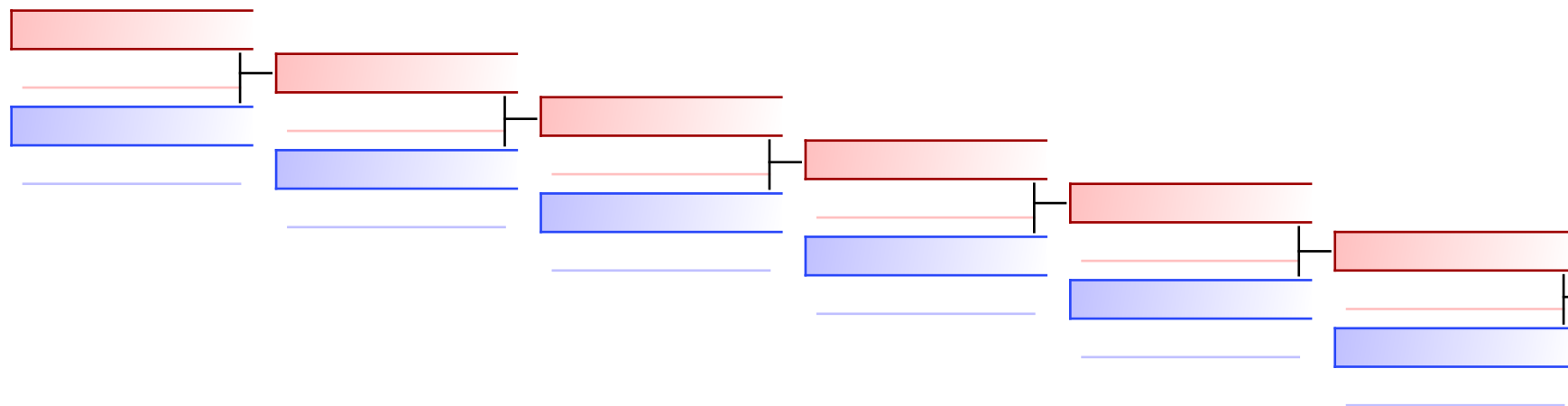

 Lopes Ivan (ESP)

 Lang Marcus (AUT)

Lion Cup 2024 Luxembourg

297 Rue de Reckenthal L-2410 Strassen, LUXEMBOURG

Court Nr.	1	Pool	1	Date	2024-06-08	Field Position	57
RED				BLUE			
NOC	SERHANI ISLEM (ALG)			NOC	DASOUL MICHAEL (BEL)		
Category	Kumite Male Senior -60kg						
3 Points	2 Points	1 Point	Score	1 Point	2 Points	3 Points	
			0 : 0				
Penatlity				Penatlity			
C1: , C2:				0:0	C1: , C2:		
				Total	WINNER		

PTS

Decision of Superiority

Judge 1	Judge 2	Judge 3	Judge 4	Judge 5	Judge 6	Judge 7	Referee

Name _____

Signature _____

Lion Cup 2024 Luxembourg

297 Rue de Reckenthal L-2410 Strassen, LUXEMBOURG

Court Nr.	1	Pool	1	Date	2024-06-08	Field Position	58
RED				BLUE			
NOC	PICAZO LUQUE ANGEL (FRA)			NOC	HANSEN HENRIK WALSTAD (NOR)		
Category	Kumite Male Senior -60kg						
3 Points	2 Points	1 Point	Score	1 Point	2 Points	3 Points	
			0 : 0				
Penatlity				Penatlity			
C1: , C2:				0:0	C1: , C2:		
				Total	WINNER		

PTS

Decision of Superiority

Judge 1	Judge 2	Judge 3	Judge 4	Judge 5	Judge 6	Judge 7	Referee

Name _____

Signature _____

Lion Cup 2024 Luxembourg

297 Rue de Reckenthal L-2410 Strassen, LUXEMBOURG

Court Nr.	1	Pool	1	Date	2024-06-08	Field Position	59
RED				BLUE			
NOC	LOPES IVAN (ESP)			NOC	TEIXEIRA TOMAS (LUX)		
Category	Kumite Male Senior -60kg						
3 Points	2 Points	1 Point	Score	1 Point	2 Points	3 Points	
			0 : 0				
Penatlity				Penatlity			
C1: , C2:			0:0	C1: , C2:			
			Total	WINNER			

PTS

Decision of Superiority

Judge 1	Judge 2	Judge 3	Judge 4	Judge 5	Judge 6	Judge 7	Referee

Name _____

Signature _____

Lion Cup 2024 Luxembourg

297 Rue de Reckenthal L-2410 Strassen, LUXEMBOURG

Court Nr.	1	Pool	1	Date	2024-06-08	Field Position	60
RED				BLUE			
NOC	LANG MARCUS (AUT)			NOC	GJEMAJL ADEMI (BEL)		
Category	Kumite Male Senior -60kg						
3 Points	2 Points	1 Point	Score	1 Point	2 Points	3 Points	
			8 : 0				
Penatlity				Penatlity			
C1: C1, C2:			8:0	C1: C1, C2:			
WINNER			Total				

PTS

Decision of Superiority

Judge 1	Judge 2	Judge 3	Judge 4	Judge 5	Judge 6	Judge 7	Referee

Name _____

Signature _____

Lion Cup 2024 Luxembourg

297 Rue de Reckenthal L-2410 Strassen, LUXEMBOURG

Court Nr.	1	Pool	1	Date	2024-06-08	Field Position	61
RED				BLUE			
NOC	DASOUL MICHAEL (BEL)			NOC	HANSEN HENRIK WALSTAD (NOR)		
Category	Kumite Male Senior -60kg						
3 Points	2 Points	1 Point	Score	1 Point	2 Points	3 Points	
			3 : 2				
Penatlity					Penatlity		
C1: HC, C2:				3:2	C1: , C2:		
WINNER				Total			

PTS

Decision of Superiority

Judge 1	Judge 2	Judge 3	Judge 4	Judge 5	Judge 6	Judge 7	Referee

Name _____

Signature _____

Lion Cup 2024 Luxembourg

297 Rue de Reckenthal L-2410 Strassen, LUXEMBOURG

Court Nr.	1	Pool	1	Date	2024-06-08	Field Position	62
RED				BLUE			
NOC	TEIXEIRA TOMAS (LUX)			NOC	LANG MARCUS (AUT)		
Category	Kumite Male Senior -60kg						
3 Points	2 Points	1 Point	Score	1 Point	2 Points	3 Points	
			10 : 3				
Penatlity					Penatlity		
C1: HC, C2:				10:3	C1: HC, C2:		
WINNER				Total			

PTS

Decision of Superiority

Judge 1	Judge 2	Judge 3	Judge 4	Judge 5	Judge 6	Judge 7	Referee

Name _____

Signature _____

Lion Cup 2024 Luxembourg

297 Rue de Reckenthal L-2410 Strassen, LUXEMBOURG

Court Nr.	1	Pool	1	Date	2024-06-08	Field Position	63	
RED				BLUE				
NOC	DASOUL MICHAEL (BEL)			NOC	TEIXEIRA TOMAS (LUX)			
Category	Kumite Male Senior -60kg							
3 Points	2 Points	1 Point	Score	1 Point	2 Points	3 Points		
			1 : 0					
Penatlity				Penatlity				
C1: HC, C2:				1:0	C1: C2, C2:			
WINNER				Total				

PTS

Decision of Superiority

Judge 1	Judge 2	Judge 3	Judge 4	Judge 5	Judge 6	Judge 7	Referee

Name _____

Signature _____

Lion Cup 2024 Luxembourg

297 Rue de Reckenthal L-2410 Strassen, LUXEMBOURG

Court Nr.	1	Pool	1	Date	2024-06-08	Field Position	0
RED				BLUE			
NOC	SERHANI ISLEM (ALG)			NOC	HANSEN HENRIK WALSTAD (NOR)		
Category	Kumite Male Senior -60kg						
3 Points	2 Points	1 Point	Score	1 Point	2 Points	3 Points	
			:				
Penatlity				Penatlity			
			Total				

Decision of Superiority

Judge 1	Judge 2	Judge 3	Judge 4	Judge 5	Judge 6	Judge 7	Referee

Name _____

Signature _____

Lion Cup 2024 Luxembourg

297 Rue de Reckenthal L-2410 Strassen, LUXEMBOURG

Court Nr.	2	Pool	2	Date	2024-06-08	Field Position	0
RED				BLUE			
NOC	LOPES IVAN (ESP)			NOC	LANG MARCUS (AUT)		
Category	Kumite Male Senior -60kg						
3 Points	2 Points	1 Point	Score	1 Point	2 Points	3 Points	
			:				
Penatlity				Penatlity			
			Total				

Decision of Superiority

Judge 1	Judge 2	Judge 3	Judge 4	Judge 5	Judge 6	Judge 7	Referee

Name _____

Signature _____

Lion Cup 2024 Luxembourg - 2024-06-07

Official Results

Kumite Male Senior -60kg			
1	DASOUL MICHAEL		BEL - BELGIUM
2	TEIXEIRA TOMAS		LUX - LUXEMBOURG
3	HANSEN HENRIK WALSTAD		NOR - NORWAY
3	LANG MARCUS		AUT - AUSTRIA
5	SERHANI ISLEM		ALG - ALGERIA
5	LOPES IVAN		ESP - SPAIN

KUMITE MALE SENIOR -67KG

Lion Cup 2024 Luxembourg

ENTRIES BY WEIGHT CATEGORY
Kumite Male Senior -67kg

As of 8 JUN 2024

NOC Code	Gender	Name	Seeding
BEL	M	Bouzahzah Isshak-Mohamed	
BEL	M	Ejja Amine	
BEL	M	Van Den Nieuwenhuijzen Leroy	
ENG	M	Monk Luke	
FRA	M	achard baptiste	
GER	M	Morina Florent	
IRL	M	O'Sullivan Conor	
LUX	M	Almalh Mahmoud	
LUX	M	Kiesgen Jimmy	
LUX	M	Tamim Yanis	
NED	M	El Mourabit Rayan	
NED	M	Roubos Sean	
NED	M	van der Weide Niek	
NED	M	Walrabenstein Sebastian	
SUI	M	Jost Ruben	

Kumite Male Senior -67kg

Lion Cup 2024 Luxembourg, 297 Rue de Reckenthal L-2410 Strassen, LUX

2024-06-08

Tatami
3 08:55

Pool
1 / 1

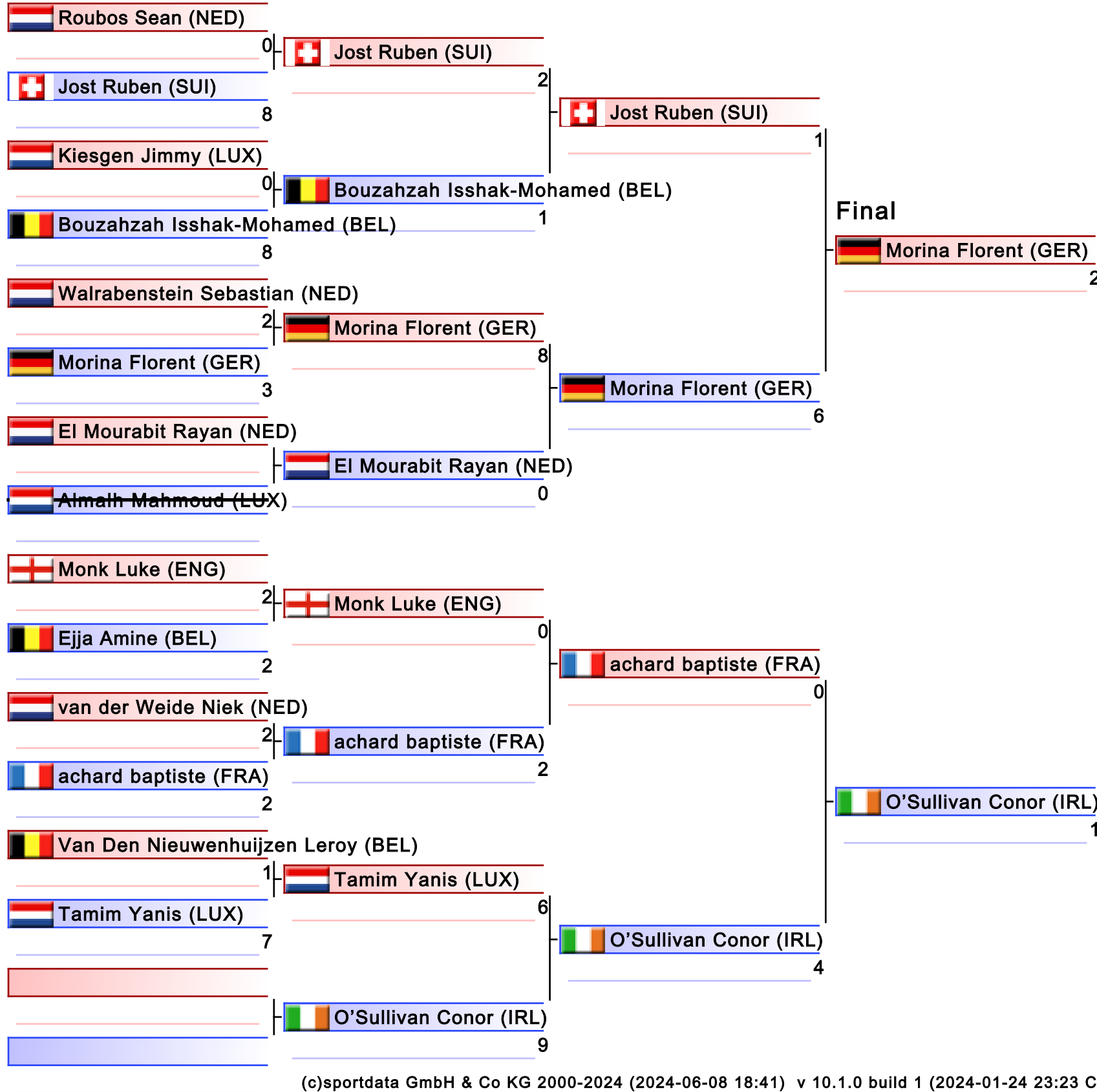

1. MORINA FLORENT (GER)
2. O'SULLIVAN CONOR (IRL)
3. TAMIM YANIS (LUX)
3. WALRABENSTEIN SEBASTIAN (NED)
5. ACHARD BAPTISTE (FRA)
5. JOST RUBEN (SUI)
7. EL MOURABIT RAYAN (NED)

Kumite Male Senior -67kg

Lion Cup 2024 Luxembourg

2024-06-08

Tatami
3 10:00

Pool
1

(c)sportdata GmbH & Co KG 2000-2024 (2024-06-08 18:41) v 10.1.0 build 1 (2024-01-24 23:23 CET) License: Online_Event_ID-7672_LionCup2024Luxembourg (expire 2024-06-21)

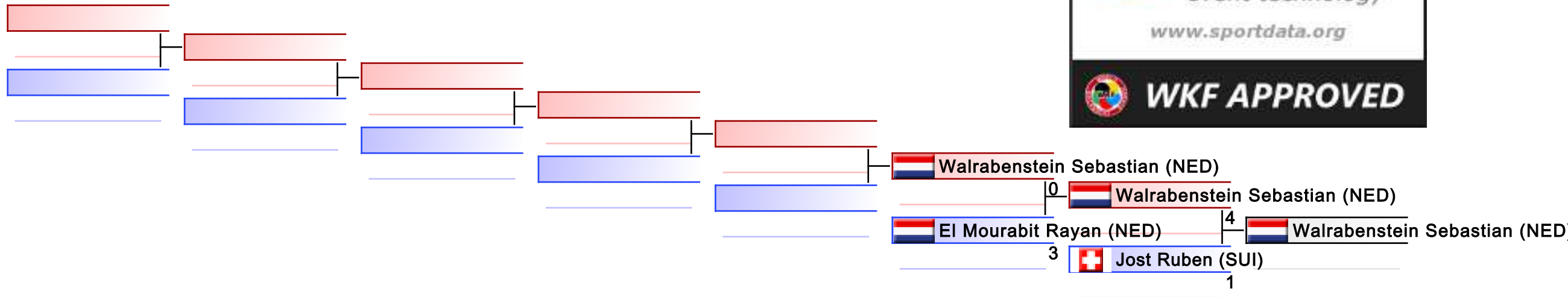

REPECHAGE: (1)

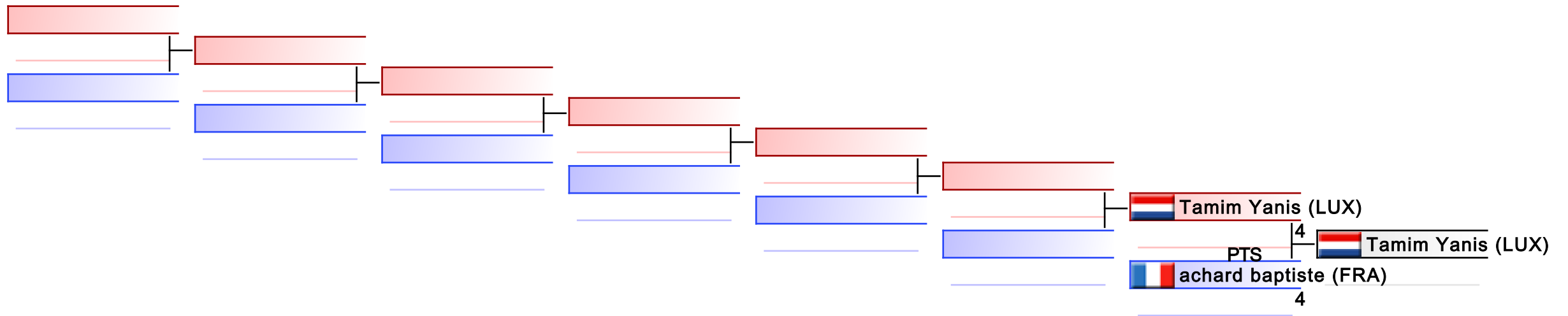

Lion Cup 2024 Luxembourg

297 Rue de Reckenthal L-2410 Strassen, LUXEMBOURG

Court Nr.	1	Pool	1	Date	2024-06-08	Field Position	49
RED				BLUE			
NOC	ROUBOS SEAN (NED)			NOC	JOST RUBEN (SUI)		
Category	Kumite Male Senior -67kg						
3 Points	2 Points	1 Point	Score	1 Point	2 Points	3 Points	
			0 : 8				
Penatlity				Penatlity			
C1: , C2:			0:8	C1: C1, C2:			
			Total	WINNER			

Decision of Superiority

Judge 1	Judge 2	Judge 3	Judge 4	Judge 5	Judge 6	Judge 7	Referee

Name _____

Signature _____

Lion Cup 2024 Luxembourg

297 Rue de Reckenthal L-2410 Strassen, LUXEMBOURG

Court Nr.	1	Pool	1	Date	2024-06-08	Field Position	50
RED				BLUE			
NOC	KIESGEN JIMMY (LUX)			NOC	BOUZHAAH ISSHAK-MOHAMED (BEL)		
Category	Kumite Male Senior -67kg						
3 Points	2 Points	1 Point	Score	1 Point	2 Points	3 Points	
			0 : 8				
Penatlity				Penatlity			
C1: C1, C2:			0:8	C1: , C2:			
			Total	WINNER			

Decision of Superiority

Judge 1	Judge 2	Judge 3	Judge 4	Judge 5	Judge 6	Judge 7	Referee

Name _____

Signature _____

Lion Cup 2024 Luxembourg

297 Rue de Reckenthal L-2410 Strassen, LUXEMBOURG

Court Nr.	1	Pool	1	Date	2024-06-08	Field Position	51	
RED				BLUE				
NOC	WALRABENSTEIN SEBASTIAN (NED)			NOC	MORINA FLORENT (GER)			
Category	Kumite Male Senior -67kg							
3 Points	2 Points	1 Point	Score	1 Point	2 Points	3 Points		
			2 : 3					
Penatlity				Penatlity				
C1: C1, C2:				2:3	C1: HC, C2:			
				Total	WINNER			

Decision of Superiority

Judge 1	Judge 2	Judge 3	Judge 4	Judge 5	Judge 6	Judge 7	Referee

Name _____

Signature _____

Lion Cup 2024 Luxembourg

297 Rue de Reckenthal L-2410 Strassen, LUXEMBOURG

Court Nr.	1	Pool	1	Date	2024-06-08	Field Position	53
RED				BLUE			
NOC	MONK LUKE (ENG)			NOC	EJJA AMINE (BEL)		
Category	Kumite Male Senior -67kg						
3 Points	2 Points	1 Point	Score	1 Point	2 Points	3 Points	
			2 : 2				
Penatlity					Penatlity		
C1: HC, C2:				2:2	C1: C1, C2:		
WINNER				Total			

Decision of Superiority

Judge 1	Judge 2	Judge 3	Judge 4	Judge 5	Judge 6	Judge 7	Referee

Name _____

Signature _____

Lion Cup 2024 Luxembourg

297 Rue de Reckenthal L-2410 Strassen, LUXEMBOURG

Court Nr.	1	Pool	1	Date	2024-06-08	Field Position	54
RED				BLUE			
NOC	VAN DER WEIDE NIEK (NED)			NOC	ACHARD BAPTISTE (FRA)		
Category	Kumite Male Senior -67kg						
3 Points	2 Points	1 Point	Score	1 Point	2 Points	3 Points	
			2 : 2				
Penatlity					Penatlity		
C1: C1, C2:				2:2	C1: , C2:		
				Total	WINNER		

Decision of Superiority

Judge 1	Judge 2	Judge 3	Judge 4	Judge 5	Judge 6	Judge 7	Referee

Name _____

Signature _____

Lion Cup 2024 Luxembourg

297 Rue de Reckenthal L-2410 Strassen, LUXEMBOURG

Court Nr.	1	Pool	1	Date	2024-06-08	Field Position	55
RED				BLUE			
NOC	VAN DEN NIEUWENHUIJZEN LEROY (BEL)			NOC	TAMIM YANIS (LUX)		
Category	Kumite Male Senior -67kg						
3 Points	2 Points	1 Point	Score	1 Point	2 Points	3 Points	
			1 : 7				
Penatlity				Penatlity			
C1: C1, C2:			1:7	C1: C2, C2:			
			Total	WINNER			

Decision of Superiority

Judge 1	Judge 2	Judge 3	Judge 4	Judge 5	Judge 6	Judge 7	Referee

Name _____

Signature _____

Lion Cup 2024 Luxembourg

297 Rue de Reckenthal L-2410 Strassen, LUXEMBOURG

Court Nr.	1	Pool	1	Date	2024-06-08	Field Position	57
RED				BLUE			
NOC	JOST RUBEN (SUI)			NOC	BOUZAHAZH ISSHAK-MOHAMED (BEL)		
Category	Kumite Male Senior -67kg						
3 Points	2 Points	1 Point	Score	1 Point	2 Points	3 Points	
			2 : 1				
Penatlity				Penatlity			
C1: , C2:				2:1	C1: C2, C2:		
WINNER				Total			

Decision of Superiority

Judge 1	Judge 2	Judge 3	Judge 4	Judge 5	Judge 6	Judge 7	Referee

Name _____

Signature _____

Lion Cup 2024 Luxembourg

297 Rue de Reckenthal L-2410 Strassen, LUXEMBOURG

Court Nr.	1	Pool	1	Date	2024-06-08	Field Position	58	
RED				BLUE				
NOC	MORINA FLORENT (GER)			NOC	EL MOURABIT RAYAN (NED)			
Category	Kumite Male Senior -67kg							
3 Points	2 Points	1 Point	Score	1 Point	2 Points	3 Points		
			8 : 0					
Penatlity				Penatlity				
C1: C1, C2:				8:0	C1: C1, C2:			
WINNER				Total				

Decision of Superiority

Judge 1	Judge 2	Judge 3	Judge 4	Judge 5	Judge 6	Judge 7	Referee

Name _____

Signature _____

Lion Cup 2024 Luxembourg

297 Rue de Reckenthal L-2410 Strassen, LUXEMBOURG

Court Nr.	1	Pool	1	Date	2024-06-08	Field Position	59
RED				BLUE			
NOC	MONK LUKE (ENG)			NOC	ACHARD BAPTISTE (FRA)		
Category	Kumite Male Senior -67kg						
3 Points	2 Points	1 Point	Score	1 Point	2 Points	3 Points	
			0 : 2				
Penatlity				Penatlity			
C1: C2, C2:			0:2	C1: , C2:			
			Total	WINNER			

Decision of Superiority

Judge 1	Judge 2	Judge 3	Judge 4	Judge 5	Judge 6	Judge 7	Referee

Name _____

Signature _____

Lion Cup 2024 Luxembourg

297 Rue de Reckenthal L-2410 Strassen, LUXEMBOURG

Court Nr.	1	Pool	1	Date	2024-06-08	Field Position	60
RED				BLUE			
NOC	TAMIM YANIS (LUX)			NOC	OSULLIVAN CONOR (IRL)		
Category	Kumite Male Senior -67kg						
3 Points	2 Points	1 Point	Score	1 Point	2 Points	3 Points	
			6 : 9				
Penatlity				Penatlity			
C1: HC, C2:			6:9	C1: C3, C2:			
			Total	WINNER			

Decision of Superiority

Judge 1	Judge 2	Judge 3	Judge 4	Judge 5	Judge 6	Judge 7	Referee

Name _____

Signature _____

Lion Cup 2024 Luxembourg

297 Rue de Reckenthal L-2410 Strassen, LUXEMBOURG

Court Nr.	1	Pool	1	Date	2024-06-08	Field Position	61
RED				BLUE			
NOC	JOST RUBEN (SUI)			NOC	MORINA FLORENT (GER)		
Category	Kumite Male Senior -67kg						
3 Points	2 Points	1 Point	Score	1 Point	2 Points	3 Points	
			1 : 6				
Penatlity				Penatlity			
C1: C2, C2:			1:6	C1: C2, C2:			
			Total	WINNER			

Decision of Superiority

Judge 1	Judge 2	Judge 3	Judge 4	Judge 5	Judge 6	Judge 7	Referee

Name _____

Signature _____

Lion Cup 2024 Luxembourg

297 Rue de Reckenthal L-2410 Strassen, LUXEMBOURG

Court Nr.	1	Pool	1	Date	2024-06-08	Field Position	62
RED				BLUE			
NOC	ACHARD BAPTISTE (FRA)			NOC	OSULLIVAN CONOR (IRL)		
Category	Kumite Male Senior -67kg						
3 Points	2 Points	1 Point	Score	1 Point	2 Points	3 Points	
			0 : 4				
Penatlity				Penatlity			
C1: , C2:			0:4	C1: HC, C2:			
			Total	WINNER			

Decision of Superiority

Judge 1	Judge 2	Judge 3	Judge 4	Judge 5	Judge 6	Judge 7	Referee

Name _____

Signature _____

Lion Cup 2024 Luxembourg

297 Rue de Reckenthal L-2410 Strassen, LUXEMBOURG

Court Nr.	1	Pool	1	Date	2024-06-08	Field Position	63	
RED				BLUE				
NOC	MORINA FLORENT (GER)			NOC	OSULLIVAN CONOR (IRL)			
Category	Kumite Male Senior -67kg							
3 Points	2 Points	1 Point	Score	1 Point	2 Points	3 Points		
			2 : 1					
Penatlity				Penatlity				
C1: C2, C2:				2:1	C1: HC, C2:			
WINNER				Total				

Decision of Superiority

Judge 1	Judge 2	Judge 3	Judge 4	Judge 5	Judge 6	Judge 7	Referee

Name _____

Signature _____

Lion Cup 2024 Luxembourg

297 Rue de Reckenthal L-2410 Strassen, LUXEMBOURG

Court Nr.	1	Pool	1	Date	2024-06-08	Field Position	0
RED				BLUE			
NOC	WALRABENSTEIN SEBASTIAN (NED)			NOC	JOST RUBEN (SUI)		
Category	Kumite Male Senior -67kg						
3 Points	2 Points	1 Point	Score	1 Point	2 Points	3 Points	
			4 : 1				
Penatlity					Penatlity		
C1: C2, C2:				4:1	C1: C2, C2:		
WINNER				Total			

Decision of Superiority

Judge 1	Judge 2	Judge 3	Judge 4	Judge 5	Judge 6	Judge 7	Referee

Name _____

Signature _____

Lion Cup 2024 Luxembourg

297 Rue de Reckenthal L-2410 Strassen, LUXEMBOURG

Court Nr.	1	Pool	1	Date	2024-06-08	Field Position	2
RED				BLUE			
NOC	WALRABENSTEIN SEBASTIAN (NED)			NOC	EL MOURABIT RAYAN (NED)		
Category	Kumite Male Senior -67kg						
3 Points	2 Points	1 Point	Score	1 Point	2 Points	3 Points	
			:				
Penatlity				Penatlity			
			Total				

Decision of Superiority

Judge 1	Judge 2	Judge 3	Judge 4	Judge 5	Judge 6	Judge 7	Referee

Name _____

Signature _____

Lion Cup 2024 Luxembourg

297 Rue de Reckenthal L-2410 Strassen, LUXEMBOURG

Court Nr.	2	Pool	2	Date	2024-06-08	Field Position	0	
RED				BLUE				
NOC	TAMIM YANIS (LUX)			NOC	ACHARD BAPTISTE (FRA)			
Category	Kumite Male Senior -67kg							
3 Points	2 Points	1 Point	Score	1 Point	2 Points	3 Points		
			4 : 4					
Penatlity				Penatlity				
C1: C2, C2:				4:4	C1: C1, C2:			
				Total	WINNER			

Decision of Superiority

Judge 1	Judge 2	Judge 3	Judge 4	Judge 5	Judge 6	Judge 7	Referee

Name _____

Signature _____

Official Results

Kumite Male Senior -67kg			
1	MORINA FLORENT		GER - GERMANY
2	O'SULLIVAN CONOR		IRL - IRELAND
3	TAMIM YANIS		LUX - LUXEMBOURG
3	WALRABENSTEIN SEBASTIAN		NED - NETHERLANDS
5	ACHARD BAPTISTE		FRA - FRANCE
5	JOST RUBEN		SUI - SWITZERLAND
7	EL MOURABIT RAYAN		NED - NETHERLANDS

KUMITE MALE SENIOR -75KG

Lion Cup 2024 Luxembourg

ENTRIES BY WEIGHT CATEGORY
Kumite Male Senior -75kg

As of 8 JUN 2024

NOC Code	Gender	Name	Seeding
AUT	M	Grigorasenco Nichita	
BEL	M	Panza Ethan	
BEL	M	pauwels lieven	
BEL	M	Roland Tom	
BEL	M	Yuksektepe Hamza	
EGY	M	Darwesh Salah	
FRA	M	ASSEMAT REMI	
GER	M	Bier Marvin	
IRL	M	Kelly Anthony	
LUX	M	Almalh Mahmoud	
LUX	M	Sibille Jordan	
LUX	M	Terlica Gomes Sebastien	
NED	M	Boudewijns Dennis	
NED	M	Buduri Arianit	
NED	M	Mastari Souhail	
NED	M	Moerkerk van Dylan	
NED	M	Teeffelen van Sebastiaan	
NED	M	Wattilete Gerson	
SUI	M	Baranyi Barnabas	
SUI	M	Del Medico Manuel	
SUI	M	DI GIOIA Raffaele	
SUI	M	OBERSON Antoine	
SUI	M	Sparer Nico	
SUI	M	Tawfik Salim	
SUI	M	Vranjes Andrej	

Kumite Male Senior -75kg

Lion Cup 2024 Luxembourg, 297 Rue de Reckenthal L-2410 Strassen, LUX

2024-06-08

Tatami
1 09:55

Pool
1 / 2

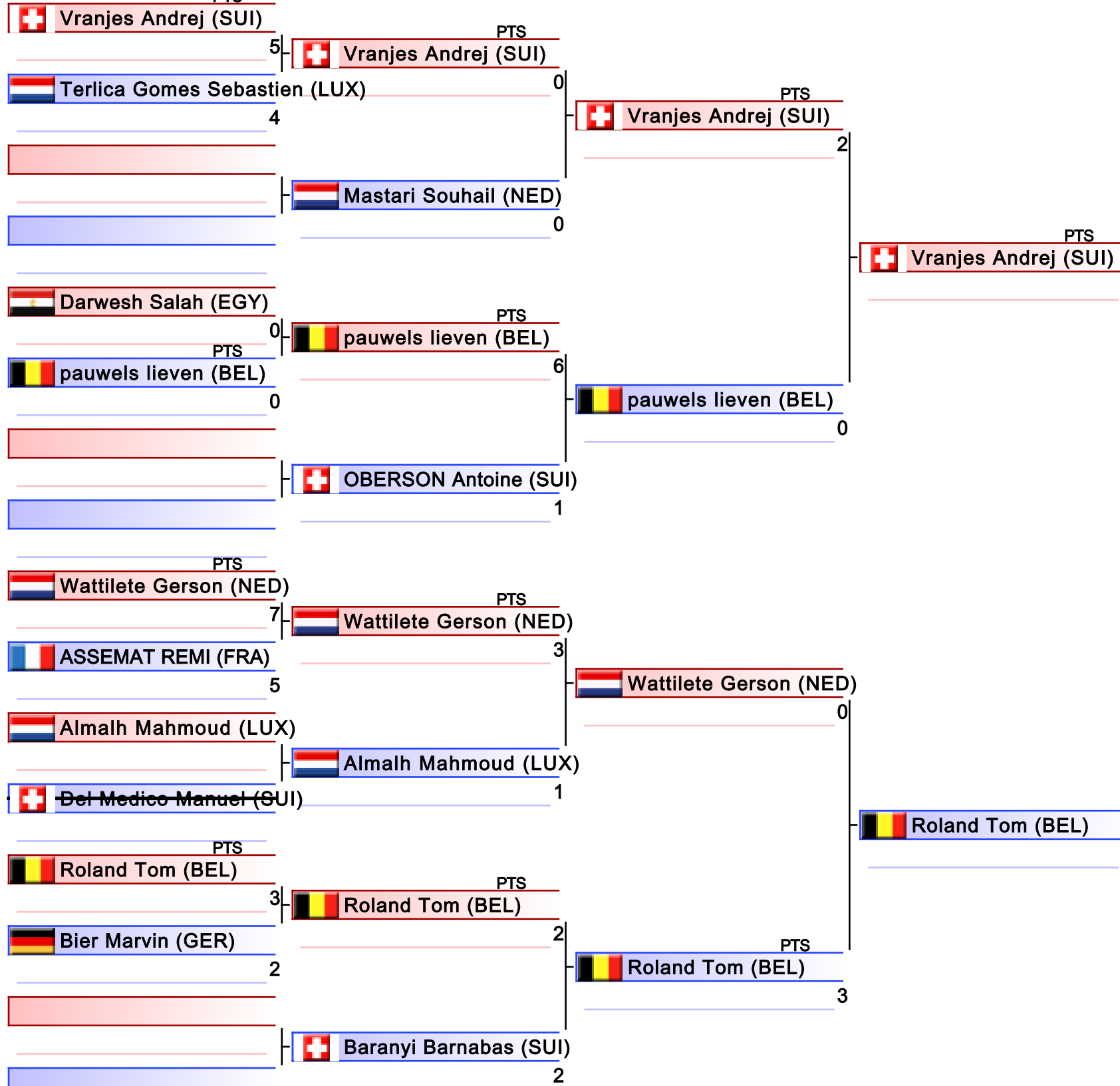

Vranjes Andrej (SUI)

1. MOERKERK VAN DYLAN (NED)
2. VRANJES ANDREJ (SUI)
3. YUKSEKTEPE HAMZA (BEL)
3. ROLAND TOM (BEL)
5. GRIGORASENCO NICHITA (AUT)
5. PAUWELS LIEVEN (BEL)
7. KELLY ANTHONY (IRL)
7. TERLICA GOMES SEBASTIEN (LUX)

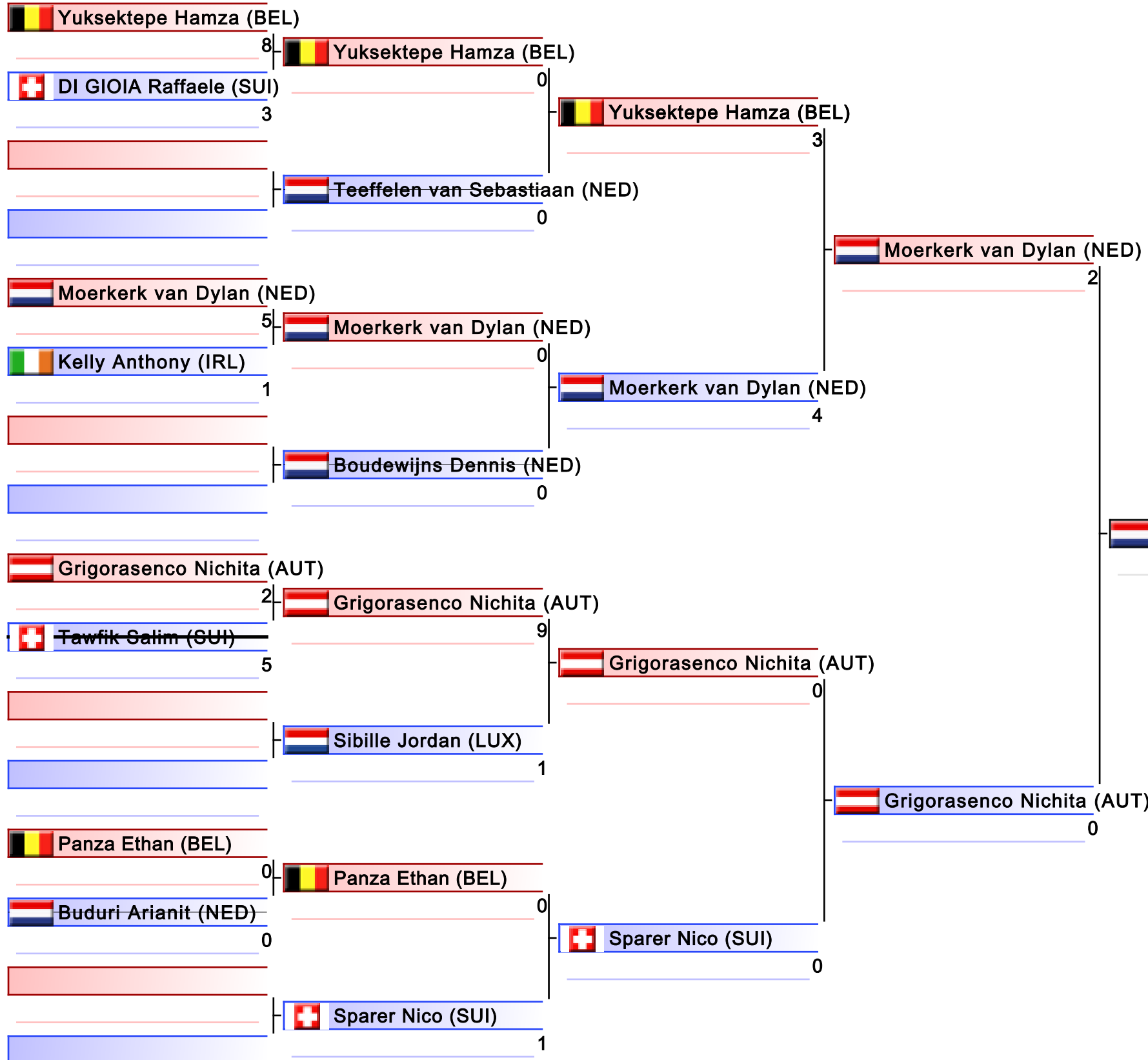

1. MOERKERK VAN DYLAN (NED)
2. VRANJES ANDREJ (SUI)
3. YUKSEKTEPE HAMZA (BEL)
3. ROLAND TOM (BEL)
5. GRIGORASENCO NICHITA (AUT)
5. PAUWELS LIEVEN (BEL)
7. KELLY ANTHONY (IRL)
7. TERLICA GOMES SEBASTIEN (LUX)

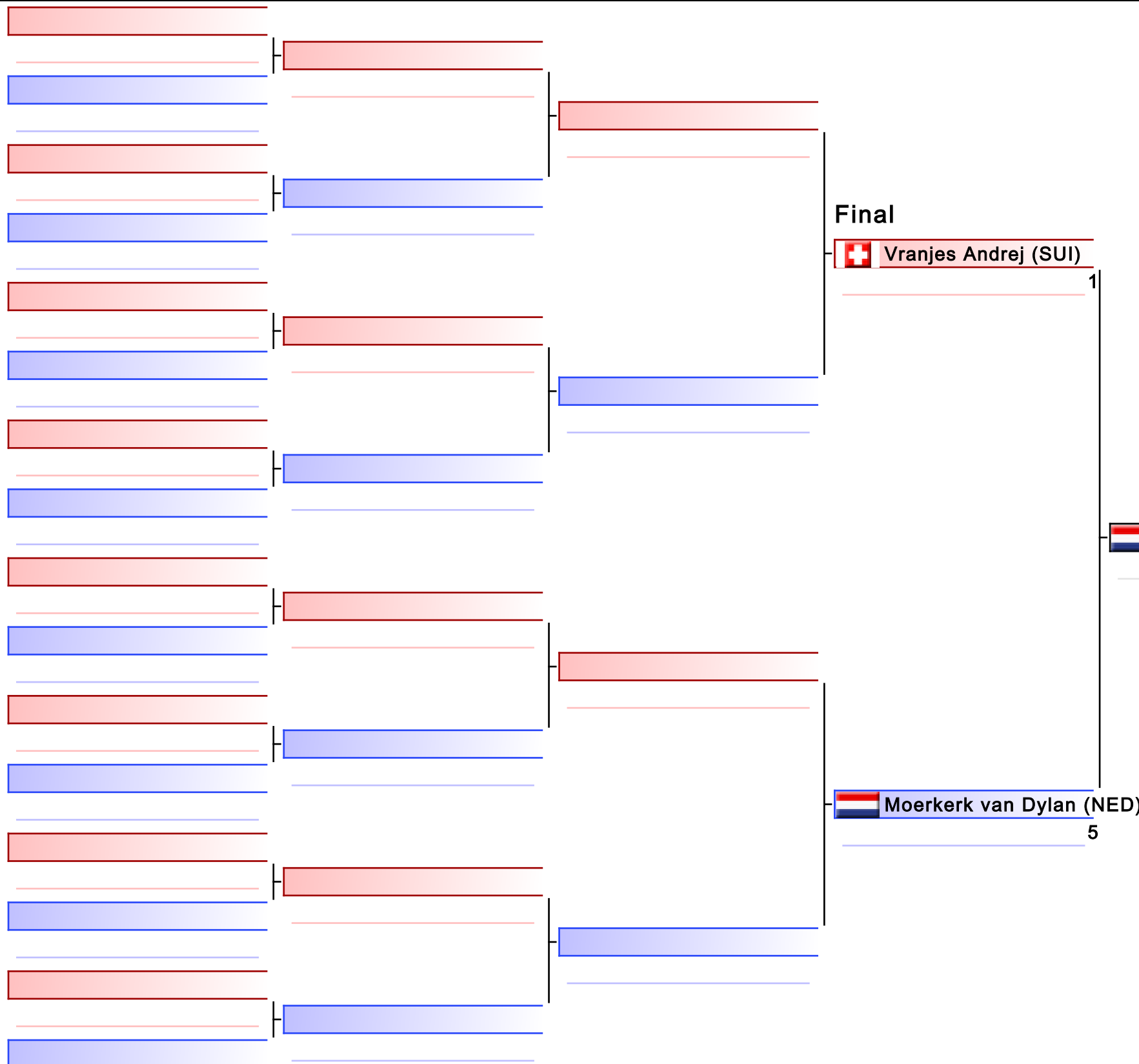

Final

Vranjes Andrej (SUI)

1

Moerkerk van Dylan (NED)

Moerkerk van Dylan (NED)

5

1. MOERKERK VAN DYLAN (NED)
2. VRANJES ANDREJ (SUI)
3. YUKSEKTEPE HAMZA (BEL)
3. ROLAND TOM (BEL)
5. GRIGORASENCO NICHITA (AUT)
5. PAUWELS LIEVEN (BEL)
7. KELLY ANTHONY (IRL)
7. TERLICA GOMES SEBASTIEN (LUX)

Kumite Male Senior -75kg

Lion Cup 2024 Luxembourg

2024-06-08

Tatami
1 10:50

Pool
1

(c)sportdata GmbH & Co KG 2000-2024 (2024-06-08 18:41) v 10.1.0 build 1 (2024-01-24 23:23 CET) License: Online_Event_ID-7672_LionCup2024Luxembourg (expire 2024-06-21)

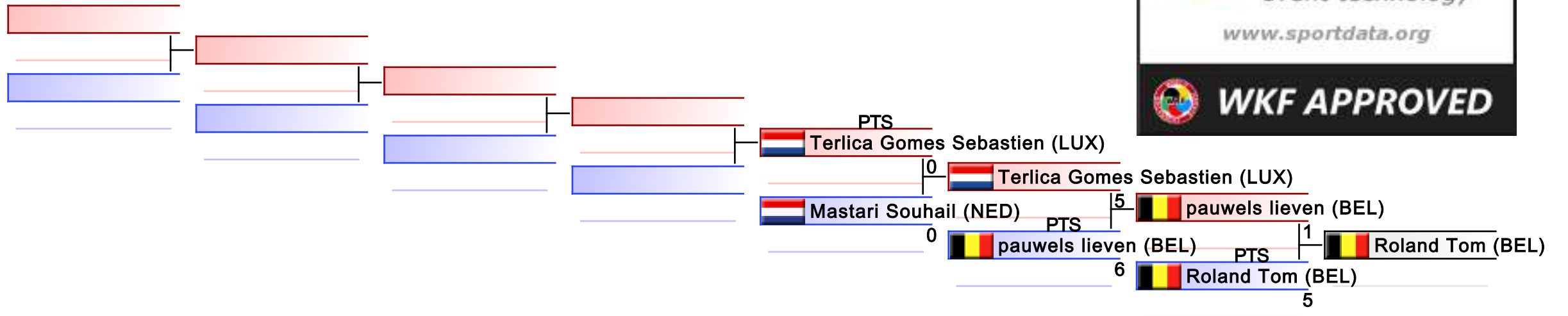

REPECHAGE: (1)

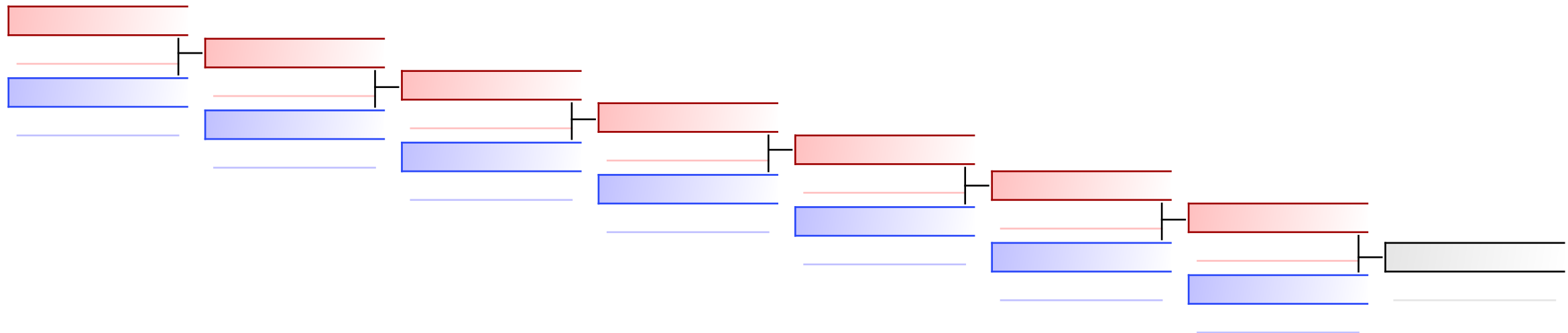

Kumite Male Senior -75kg

Lion Cup 2024 Luxembourg

2024-06-08

Tatami
2 10:50

Pool
2

(c)sportdata GmbH & Co KG 2000-2024 (2024-06-08 18:41) v 10.1.0 build 1 (2024-01-24 23:23 CET) License: Online_Event_ID-7672_LionCup2024Luxembourg (expire 2024-06-21)

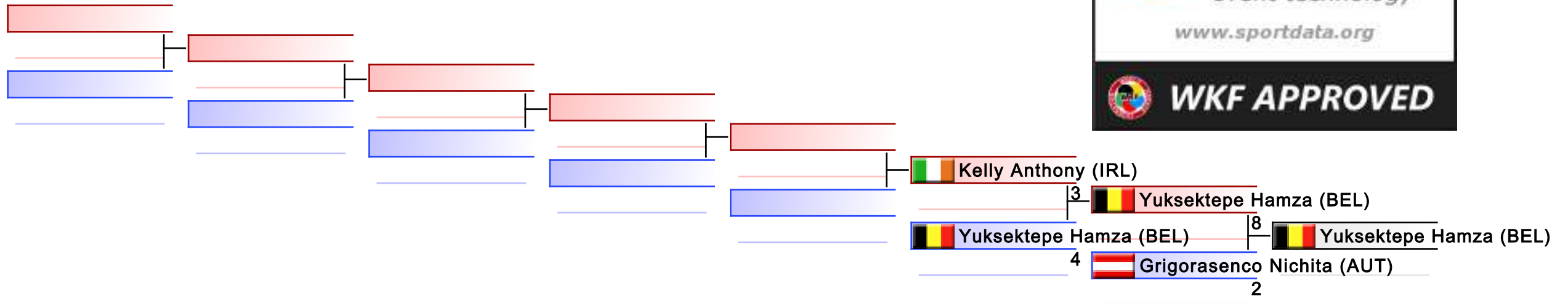

REPECHAGE: (2)

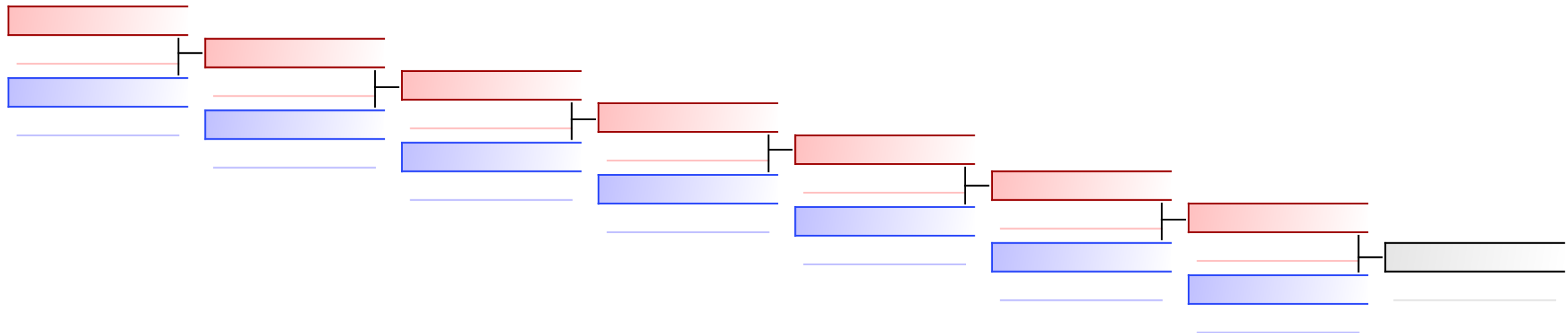

Lion Cup 2024 Luxembourg

297 Rue de Reckenthal L-2410 Strassen, LUXEMBOURG

Court Nr.	1	Pool	1	Date	2024-06-08	Field Position	49
RED				BLUE			
NOC	VRANJES ANDREJ (SUI)			NOC	TERLICA GOMES SEBASTIEN (LUX)		
Category	Kumite Male Senior -75kg						
3 Points	2 Points	1 Point	Score	1 Point	2 Points	3 Points	
			5 : 4				
Penatlity					Penatlity		
C1: C2, C2:				5:4	C1: , C2:		
WINNER				Total			

PTS

Decision of Superiority

Judge 1	Judge 2	Judge 3	Judge 4	Judge 5	Judge 6	Judge 7	Referee

Name _____

Signature _____

Lion Cup 2024 Luxembourg

297 Rue de Reckenthal L-2410 Strassen, LUXEMBOURG

Court Nr.	1	Pool	1	Date	2024-06-08	Field Position	51
RED				BLUE			
NOC	DARWESH SALAH (EGY)			NOC	PAUWELS LIEVEN (BEL)		
Category	Kumite Male Senior -75kg						
3 Points	2 Points	1 Point	Score	1 Point	2 Points	3 Points	
			0 : 0				
Penatlity				Penatlity			
C1: , C2:			0:0	C1: , C2:			
			Total	WINNER			

PTS

Decision of Superiority

Judge 1	Judge 2	Judge 3	Judge 4	Judge 5	Judge 6	Judge 7	Referee

Name _____

Signature _____

Lion Cup 2024 Luxembourg

297 Rue de Reckenthal L-2410 Strassen, LUXEMBOURG

Court Nr.	1	Pool	1	Date	2024-06-08	Field Position	53
RED				BLUE			
NOC	WATTILETE GERSON (NED)			NOC	ASSEMAT REMI (FRA)		
Category	Kumite Male Senior -75kg						
3 Points	2 Points	1 Point	Score	1 Point	2 Points	3 Points	
			7 : 5				
Penatlity				Penatlity			
C1: C1, C2:				7:5	C1: C1, C2:		
WINNER				Total			

PTS

Decision of Superiority

Judge 1	Judge 2	Judge 3	Judge 4	Judge 5	Judge 6	Judge 7	Referee

Name _____

Signature _____

Lion Cup 2024 Luxembourg

297 Rue de Reckenthal L-2410 Strassen, LUXEMBOURG

Court Nr.	1	Pool	1	Date	2024-06-08	Field Position	55
RED				BLUE			
NOC	ROLAND TOM (BEL)			NOC	BIER MARVIN (GER)		
Category	Kumite Male Senior -75kg						
3 Points	2 Points	1 Point	Score	1 Point	2 Points	3 Points	
			3 : 2				
Penatlity					Penatlity		
C1: HC, C2:				3:2	C1: C2, C2:		
WINNER				Total			

PTS

Decision of Superiority

Judge 1	Judge 2	Judge 3	Judge 4	Judge 5	Judge 6	Judge 7	Referee

Name _____

Signature _____

Lion Cup 2024 Luxembourg

297 Rue de Reckenthal L-2410 Strassen, LUXEMBOURG

Court Nr.	1	Pool	1	Date	2024-06-08	Field Position	57
RED				BLUE			
NOC	VRANJES ANDREJ (SUI)			NOC	MASTARI SOUHAIL (NED)		
Category	Kumite Male Senior -75kg						
3 Points	2 Points	1 Point	Score	1 Point	2 Points	3 Points	
			0 : 0				
Penatlity				Penatlity			
C1: , C2:				0:0	C1: , C2:		
WINNER				Total			

PTS

Decision of Superiority

Judge 1	Judge 2	Judge 3	Judge 4	Judge 5	Judge 6	Judge 7	Referee

Name _____

Signature _____

Lion Cup 2024 Luxembourg

297 Rue de Reckenthal L-2410 Strassen, LUXEMBOURG

Court Nr.	1	Pool	1	Date	2024-06-08	Field Position	58
RED				BLUE			
NOC	PAUWELS LIEVEN (BEL)			NOC	OBERSON ANTOINE (SUI)		
Category	Kumite Male Senior -75kg						
3 Points	2 Points	1 Point	Score	1 Point	2 Points	3 Points	
			6 : 1				
Penatlity					Penatlity		
C1: , C2:				6:1	C1: , C2:		
WINNER				Total			

PTS

Decision of Superiority

Judge 1	Judge 2	Judge 3	Judge 4	Judge 5	Judge 6	Judge 7	Referee

Name _____

Signature _____

Lion Cup 2024 Luxembourg

297 Rue de Reckenthal L-2410 Strassen, LUXEMBOURG

Court Nr.	1	Pool	1	Date	2024-06-08	Field Position	59	
RED				BLUE				
NOC	WATTILETE GERSON (NED)			NOC	ALMALH MAHMOUD (LUX)			
Category	Kumite Male Senior -75kg							
3 Points	2 Points	1 Point	Score	1 Point	2 Points	3 Points		
			3 : 1					
Penatlity				Penatlity				
C1: C1, C2:				3:1	C1: HC, C2:			
WINNER				Total				

PTS

Decision of Superiority

Judge 1	Judge 2	Judge 3	Judge 4	Judge 5	Judge 6	Judge 7	Referee

Name _____

Signature _____

Lion Cup 2024 Luxembourg

297 Rue de Reckenthal L-2410 Strassen, LUXEMBOURG

Court Nr.	1	Pool	1	Date	2024-06-08	Field Position	60
RED				BLUE			
NOC	ROLAND TOM (BEL)			NOC	BARANYI BARNABAS (SUI)		
Category	Kumite Male Senior -75kg						
3 Points	2 Points	1 Point	Score	1 Point	2 Points	3 Points	
			2 : 2				
Penatlity				Penatlity			
C1: HC, C2:				2:2	C1: , C2:		
WINNER				Total			

PTS

Decision of Superiority

Judge 1	Judge 2	Judge 3	Judge 4	Judge 5	Judge 6	Judge 7	Referee

Name _____

Signature _____

Lion Cup 2024 Luxembourg

297 Rue de Reckenthal L-2410 Strassen, LUXEMBOURG

Court Nr.	1	Pool	1	Date	2024-06-08	Field Position	61	
RED				BLUE				
NOC	VRANJES ANDREJ (SUI)			NOC	PAUWELS LIEVEN (BEL)			
Category	Kumite Male Senior -75kg							
3 Points	2 Points	1 Point	Score	1 Point	2 Points	3 Points		
			2 : 0					
Penatlity				Penatlity				
C1: HC, C2:				2:0	C1: C1, C2:			
WINNER				Total				

PTS

Decision of Superiority

Judge 1	Judge 2	Judge 3	Judge 4	Judge 5	Judge 6	Judge 7	Referee

Name _____

Signature _____

Lion Cup 2024 Luxembourg

297 Rue de Reckenthal L-2410 Strassen, LUXEMBOURG

Court Nr.	1	Pool	1	Date	2024-06-08	Field Position	62
RED				BLUE			
NOC	WATTILETE GERSON (NED)			NOC	ROLAND TOM (BEL)		
Category	Kumite Male Senior -75kg						
3 Points	2 Points	1 Point	Score	1 Point	2 Points	3 Points	
			0 : 3				
Penatlity					Penatlity		
C1: C1, C2:				0:3	C1: HC, C2:		
				Total	WINNER		

PTS

Decision of Superiority

Judge 1	Judge 2	Judge 3	Judge 4	Judge 5	Judge 6	Judge 7	Referee

Name _____

Signature _____

Lion Cup 2024 Luxembourg

297 Rue de Reckenthal L-2410 Strassen, LUXEMBOURG

Court Nr.	1	Pool	1	Date	2024-06-08	Field Position	63
RED				BLUE			
NOC	VRANJES ANDREJ (SUI)			NOC	ROLAND TOM (BEL)		
Category	Kumite Male Senior -75kg						
3 Points	2 Points	1 Point	Score	1 Point	2 Points	3 Points	
			7 : 4				
Penatlity					Penatlity		
C1: C3, C2:				7:4	C1: C2, C2:		
WINNER				Total			

PTS

Decision of Superiority

Judge 1	Judge 2	Judge 3	Judge 4	Judge 5	Judge 6	Judge 7	Referee

Name _____

Signature _____

Lion Cup 2024 Luxembourg

297 Rue de Reckenthal L-2410 Strassen, LUXEMBOURG

Court Nr.	2	Pool	2	Date	2024-06-08	Field Position	49	
RED				BLUE				
NOC	YUKSEKTEPE HAMZA (BEL)			NOC	DI GIOIA RAFFAELE (SUI)			
Category	Kumite Male Senior -75kg							
3 Points	2 Points	1 Point	Score	1 Point	2 Points	3 Points		
			8 : 3					
Penatlity				Penatlity				
C1: C3, C2:				8:3	C1: , C2:			
WINNER				Total				

Decision of Superiority

Judge 1	Judge 2	Judge 3	Judge 4	Judge 5	Judge 6	Judge 7	Referee

Name _____

Signature _____

Lion Cup 2024 Luxembourg

297 Rue de Reckenthal L-2410 Strassen, LUXEMBOURG

Court Nr.	2	Pool	2	Date	2024-06-08	Field Position	51
RED				BLUE			
NOC	MOERKERK VAN DYLAN (NED)			NOC	KELLY ANTHONY (IRL)		
Category	Kumite Male Senior -75kg						
3 Points	2 Points	1 Point	Score	1 Point	2 Points	3 Points	
			5 : 1				
Penatlity					Penatlity		
C1: C2, C2:				5:1	C1: , C2:		
WINNER				Total			

Decision of Superiority

Judge 1	Judge 2	Judge 3	Judge 4	Judge 5	Judge 6	Judge 7	Referee

Name _____

Signature _____

Lion Cup 2024 Luxembourg

297 Rue de Reckenthal L-2410 Strassen, LUXEMBOURG

Court Nr.	2	Pool	2	Date	2024-06-08	Field Position	59
RED				BLUE			
NOC	GRIGORASENCO NICHITA (AUT)			NOC	SIBILLE JORDAN (LUX)		
Category	Kumite Male Senior -75kg						
3 Points	2 Points	1 Point	Score	1 Point	2 Points	3 Points	
			9 : 1				
Penatlity					Penatlity		
C1: C2, C2:				9:1	C1: HC, C2:		
WINNER				Total			

Decision of Superiority

Judge 1	Judge 2	Judge 3	Judge 4	Judge 5	Judge 6	Judge 7	Referee

Name _____

Signature _____

Lion Cup 2024 Luxembourg

297 Rue de Reckenthal L-2410 Strassen, LUXEMBOURG

Court Nr.	2	Pool	2	Date	2024-06-08	Field Position	60
RED				BLUE			
NOC	PANZA ETHAN (BEL)			NOC	SPARER NICO (SUI)		
Category	Kumite Male Senior -75kg						
3 Points	2 Points	1 Point	Score	1 Point	2 Points	3 Points	
			0 : 1				
Penatlity				Penatlity			
C1: C1, C2:			0:1	C1: C2, C2:			
			Total	WINNER			

Decision of Superiority

Judge 1	Judge 2	Judge 3	Judge 4	Judge 5	Judge 6	Judge 7	Referee

Name _____

Signature _____

Lion Cup 2024 Luxembourg

297 Rue de Reckenthal L-2410 Strassen, LUXEMBOURG

Court Nr.	2	Pool	2	Date	2024-06-08	Field Position	61
RED				BLUE			
NOC	YUKSEKTEPE HAMZA (BEL)			NOC	MOERKERK VAN DYLAN (NED)		
Category	Kumite Male Senior -75kg						
3 Points	2 Points	1 Point	Score	1 Point	2 Points	3 Points	
			3 : 4				
Penatlity					Penatlity		
C1: C1, C2:				3:4	C1: , C2:		
				Total	WINNER		

Decision of Superiority

Judge 1	Judge 2	Judge 3	Judge 4	Judge 5	Judge 6	Judge 7	Referee

Name _____

Signature _____

Lion Cup 2024 Luxembourg

297 Rue de Reckenthal L-2410 Strassen, LUXEMBOURG

Court Nr.	2	Pool	2	Date	2024-06-08	Field Position	62
RED				BLUE			
NOC	GRIGORASENCO NICHITA (AUT)			NOC	SPARER NICO (SUI)		
Category	Kumite Male Senior -75kg						
3 Points	2 Points	1 Point	Score	1 Point	2 Points	3 Points	
			0 : 0				
Penatlity					Penatlity		
C1: C2, C2:				0:0	C1: C2, C2:		
WINNER				Total			

Decision of Superiority

Judge 1	Judge 2	Judge 3	Judge 4	Judge 5	Judge 6	Judge 7	Referee

Name _____

Signature _____

Lion Cup 2024 Luxembourg

297 Rue de Reckenthal L-2410 Strassen, LUXEMBOURG

Court Nr.	2	Pool	2	Date	2024-06-08	Field Position	63	
RED				BLUE				
NOC	MOERKERK VAN DYLAN (NED)			NOC	GRIGORASENCO NICHITA (AUT)			
Category	Kumite Male Senior -75kg							
3 Points	2 Points	1 Point	Score	1 Point	2 Points	3 Points		
			2 : 0					
Penatlity				Penatlity				
C1: HC, C2:				2:0	C1: C1, C2:			
WINNER				Total				

Decision of Superiority

Judge 1	Judge 2	Judge 3	Judge 4	Judge 5	Judge 6	Judge 7	Referee

Name _____

Signature _____

Lion Cup 2024 Luxembourg

297 Rue de Reckenthal L-2410 Strassen, LUXEMBOURG

Court Nr.	1	Pool	1	Date	2024-06-08	Field Position	63
RED				BLUE			
NOC	VRANJES ANDREJ (SUI)			NOC	MOERKERK VAN DYLAN (NED)		
Category	Kumite Male Senior -75kg						
3 Points	2 Points	1 Point	Score	1 Point	2 Points	3 Points	
			1 : 5				
Penatlity				Penatlity			
C1: , C2:				1:5	C1: , C2:		
				Total	WINNER		

Decision of Superiority

Judge 1	Judge 2	Judge 3	Judge 4	Judge 5	Judge 6	Judge 7	Referee

Name _____

Signature _____

Lion Cup 2024 Luxembourg

297 Rue de Reckenthal L-2410 Strassen, LUXEMBOURG

Court Nr.	1	Pool	1	Date	2024-06-08	Field Position	0	
RED				BLUE				
NOC	PAUWELS LIEVEN (BEL)			NOC	ROLAND TOM (BEL)			
Category	Kumite Male Senior -75kg							
3 Points	2 Points	1 Point	Score	1 Point	2 Points	3 Points		
			1 : 5					
Penatlity				Penatlity				
C1: C2, C2:				1:5	C1: HC, C2:			
				Total	WINNER			

PTS

Decision of Superiority

Judge 1	Judge 2	Judge 3	Judge 4	Judge 5	Judge 6	Judge 7	Referee

Name _____

Signature _____

Lion Cup 2024 Luxembourg

297 Rue de Reckenthal L-2410 Strassen, LUXEMBOURG

Court Nr.	1	Pool	1	Date	2024-06-08	Field Position	2	
RED				BLUE				
NOC	TERLICA GOMES SEBASTIEN (LUX)			NOC	PAUWELS LIEVEN (BEL)			
Category	Kumite Male Senior -75kg							
3 Points	2 Points	1 Point	Score	1 Point	2 Points	3 Points		
			5 : 6					
Penatlity				Penatlity				
C1: C1, C2:				5:6	C1: C3, C2:			
				Total	WINNER			

PTS

Decision of Superiority

Judge 1	Judge 2	Judge 3	Judge 4	Judge 5	Judge 6	Judge 7	Referee

Name _____

Signature _____

Lion Cup 2024 Luxembourg

297 Rue de Reckenthal L-2410 Strassen, LUXEMBOURG

Court Nr.	1	Pool	1	Date	2024-06-08	Field Position	4
RED				BLUE			
NOC	TERLICA GOMES SEBASTIEN (LUX)			NOC	MASTARI SOUHAIL (NED)		
Category	Kumite Male Senior -75kg						
3 Points	2 Points	1 Point	Score	1 Point	2 Points	3 Points	
			:				
Penatlity				Penatlity			
			Total				

Decision of Superiority

Judge 1	Judge 2	Judge 3	Judge 4	Judge 5	Judge 6	Judge 7	Referee

Name _____

Signature _____

Official Results

Kumite Male Senior -75kg			
1	MOERKERK VAN DYLAN		NED - NETHERLANDS
2	VRANJES ANDREJ		SUI - SWITZERLAND
3	YUKSEKTEPE HAMZA		BEL - BELGIUM
3	ROLAND TOM		BEL - BELGIUM
5	GRIGORASENCO NICHITA		AUT - AUSTRIA
5	PAUWELS LIEVEN		BEL - BELGIUM
7	KELLY ANTHONY		IRL - IRELAND
7	TERLICA GOMES SEBASTIEN		LUX - LUXEMBOURG
9	MASTARI SOUHAIL		NED - NETHERLANDS

KUMITE MALE SENIOR -84KG

Lion Cup 2024 Luxembourg

ENTRIES BY WEIGHT CATEGORY
Kumite Male Senior -84kg

As of 8 JUN 2024

NOC Code	Gender	Name	Seeding
ALG	M	Moudir Adel	
BEL	M	Abu Khalil Mohammad	
BEL	M	Anisimov Danyil	
BEL	M	Blavier Anthony	
BEL	M	El mesbahi ali	
BEL	M	messoudi elias	
EGY	M	Aly Ossama	
NED	M	Overman Jean-Claude	
SUI	M	Dobberstein Lennox	

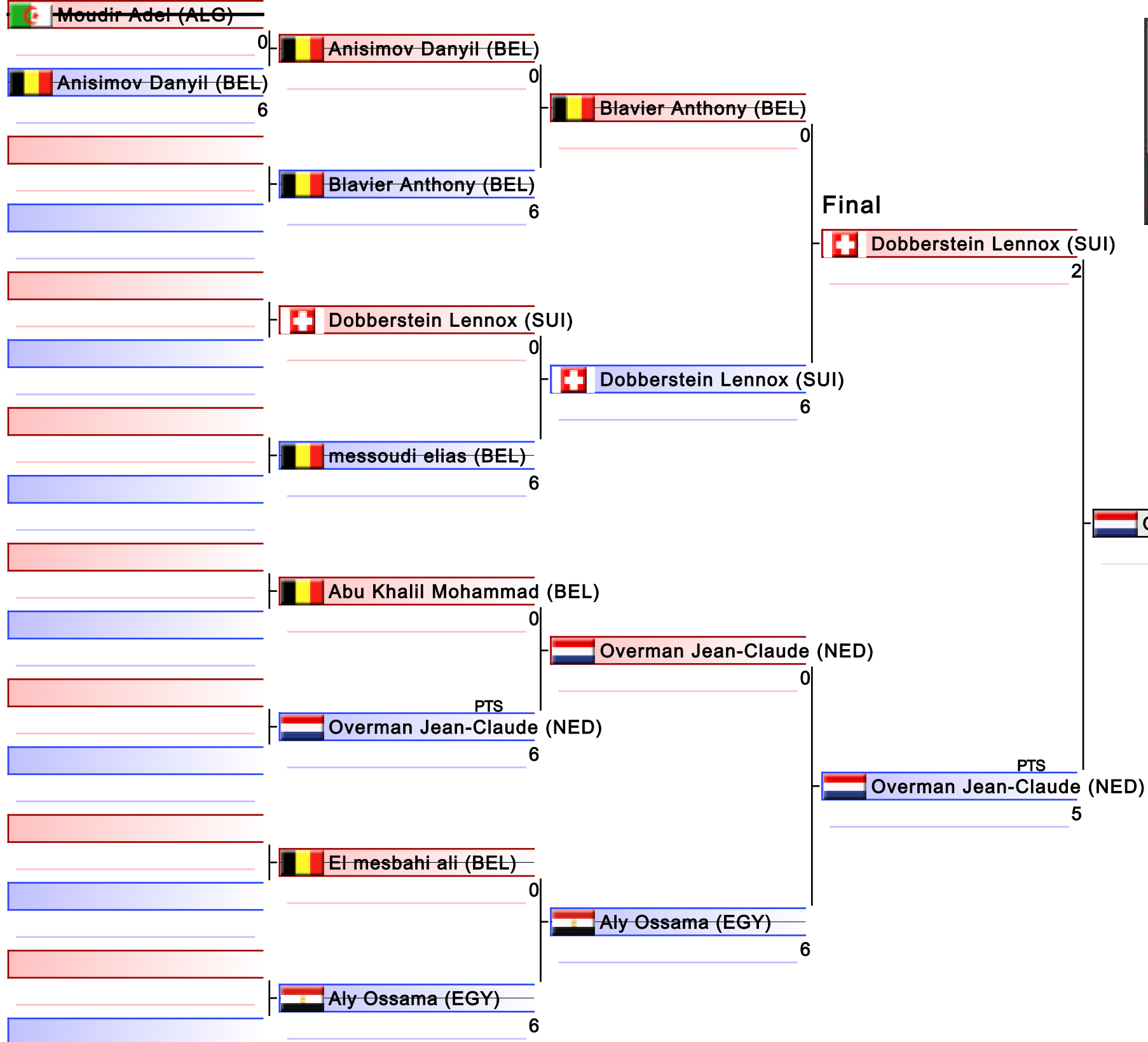

1. OVERMAN JEAN-CLAUDE (NED)
2. DOBBERSTEIN LENNOX (SUI)
3. ABU KHALIL MOHAMMAD (BEL)

Kumite Male Senior -84kg

Lion Cup 2024 Luxembourg

2024-06-08

Tatami
2 09:30

Pool
1

(c)sportdata GmbH & Co KG 2000-2024 (2024-06-08 18:41) v 10.1.0 build 1 (2024-01-24 23:23 CET) License: Online_Event_ID-7672_LionCup2024Luxembourg (expire 2024-06-21)

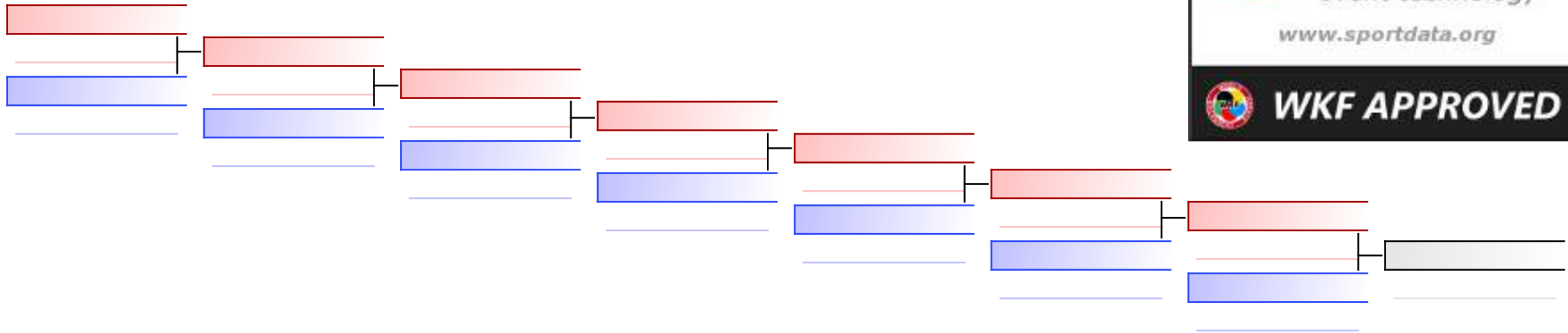

REPECHAGE: (1)

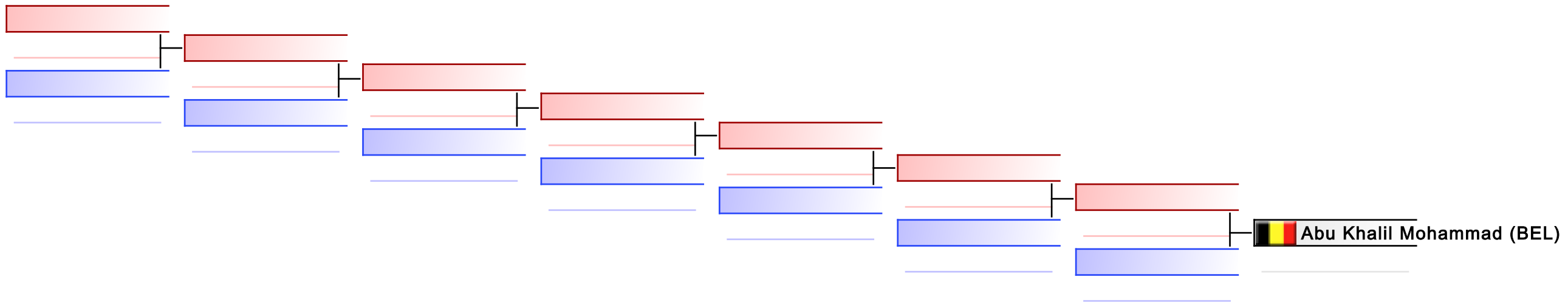

Lion Cup 2024 Luxembourg

297 Rue de Reckenthal L-2410 Strassen, LUXEMBOURG

Court Nr.	1	Pool	1	Date	2024-06-08	Field Position	59	
RED				BLUE				
NOC	ABU KHALIL MOHAMMAD (BEL)			NOC	OVERMAN JEAN-CLAUDE (NED)			
Category	Kumite Male Senior -84kg							
3 Points	2 Points	1 Point	Score	1 Point	2 Points	3 Points		
			0 : 6					
Penatlity				Penatlity				
C1: C2, C2:				0:6	C1: , C2:			
				Total	WINNER			

PTS

Decision of Superiority

Judge 1	Judge 2	Judge 3	Judge 4	Judge 5	Judge 6	Judge 7	Referee

Name _____

Signature _____

Lion Cup 2024 Luxembourg

297 Rue de Reckenthal L-2410 Strassen, LUXEMBOURG

Court Nr.	1	Pool	1	Date	2024-06-08	Field Position	63
RED				BLUE			
NOC	DOBBERSTEIN LENNOX (SUI)			NOC	OVERMAN JEAN-CLAUDE (NED)		
Category	Kumite Male Senior -84kg						
3 Points	2 Points	1 Point	Score	1 Point	2 Points	3 Points	
			2 : 5				
Penatlity				Penatlity			
C1: , C2:			2:5	C1: , C2:			
			Total	WINNER			

PTS

Decision of Superiority



Judge 1	Judge 2	Judge 3	Judge 4	Judge 5	Judge 6	Judge 7	Referee

Name _____

Signature _____

Lion Cup 2024 Luxembourg - 2024-06-07

Official Results

Kumite Male Senior -84kg			
1	OVERMAN JEAN-CLAUDE		NED - NETHERLANDS
2	DOBBERSTEIN LENNOX		SUI - SWITZERLAND
3	ABU KHALIL MOHAMMAD		BEL - BELGIUM

KUMITE MALE U12 +45KG

Lion Cup 2024 Luxembourg

ENTRIES BY WEIGHT CATEGORY
Kumite Male U12 +45kg

As of 8 JUN 2024

NOC Code	Gender	Name	Seeding
EGY	M	Elrashidy Ahmed	
LUX	M	Ferreira Perdigao Rodrigo	
LUX	M	Pupkus Lukas	
LUX	M	Tashchuk Oleh	
LUX	M	Wagener Mathis	
NED	M	Kaya Fatih	
SUI	M	Zendeli Meriton	

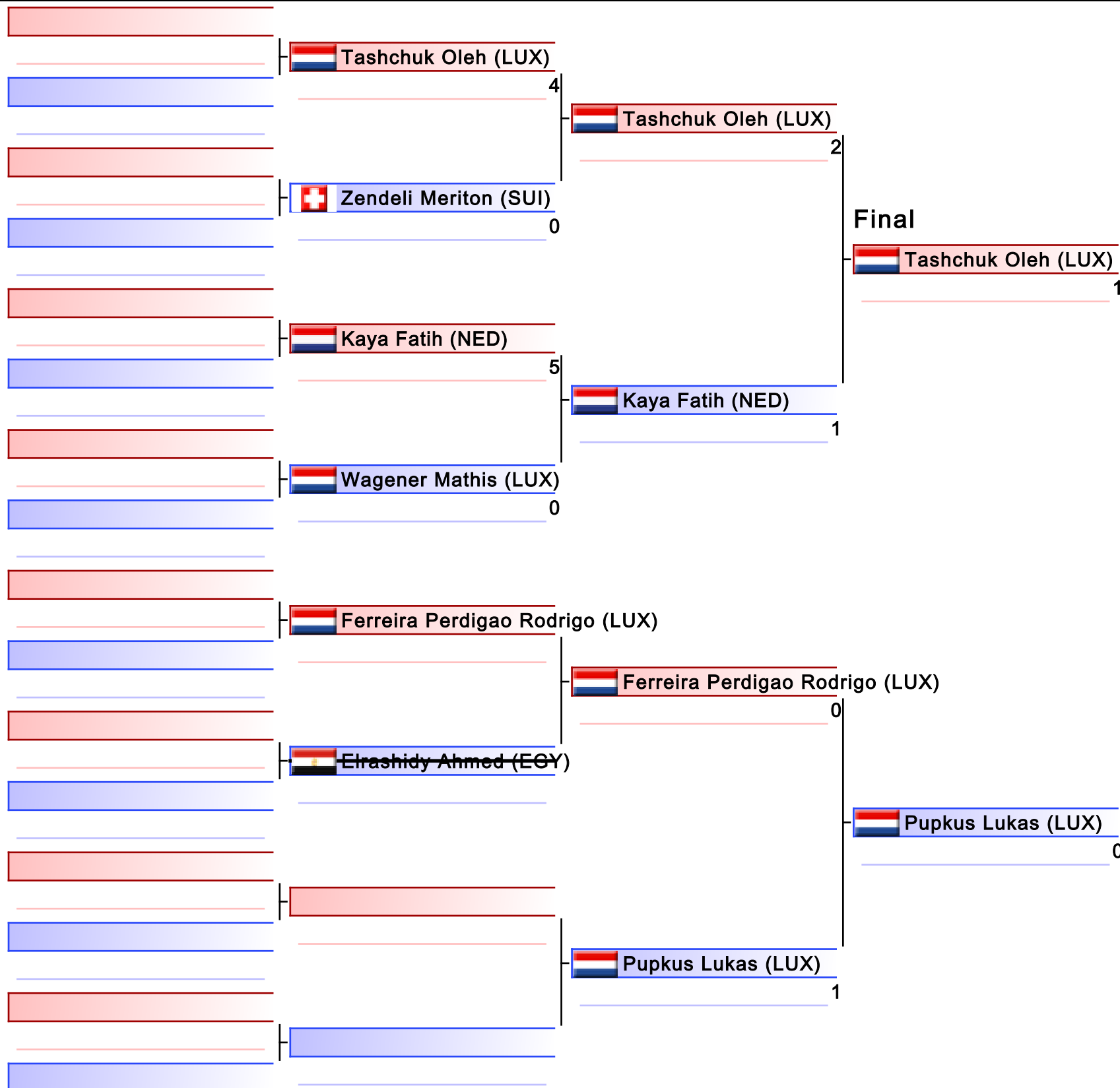

1. TASHCHUK OLEH (LUX)
2. PUPKUS LUKAS (LUX)
3. FERREIRA PERDIGAO RODRIGO (LUX)
3. ZENDELI MERITON (SUI)
5. KAYA FATIH (NED)

Kumite Male U12 +45kg

Lion Cup 2024 Luxembourg

Tatami

Pool

1

(c)sportdata GmbH & Co KG 2000-2024 (2024-06-08 18:41) v 10.1.0 build 1 (2024-01-24 23:23 CET) License: Online_Event_ID-7672_LionCup2024Luxembourg (expire 2024-06-21)

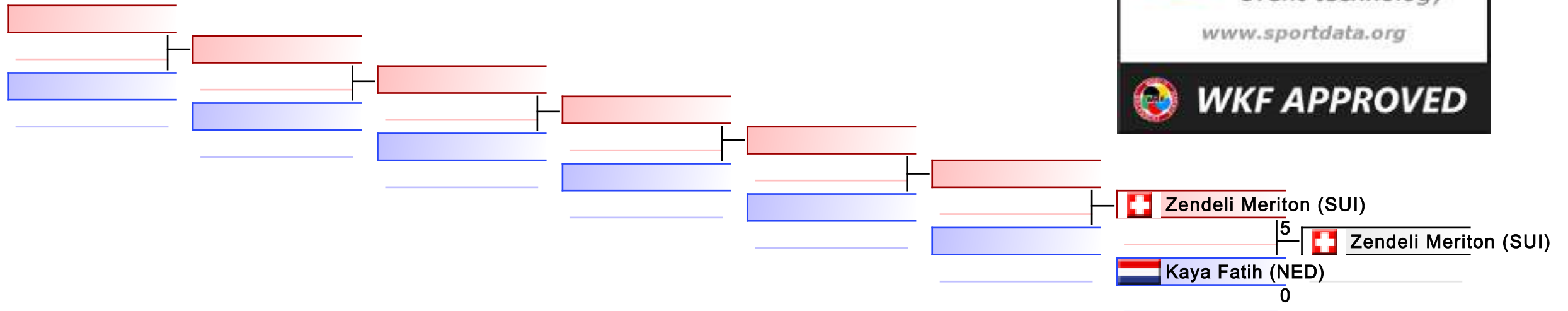

REPECHAGE: (1)

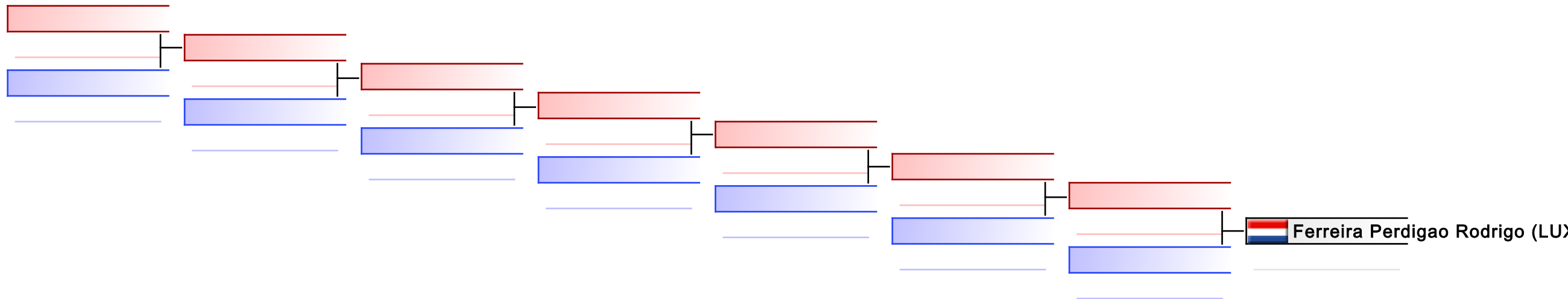

Lion Cup 2024 Luxembourg

297 Rue de Reckenthal L-2410 Strassen, LUXEMBOURG

Court Nr.	1	Pool	1	Date	2024-06-08	Field Position	57	
RED				BLUE				
NOC	TASHCHUK OLEH (LUX)			NOC	ZENDELI MERITON (SUI)			
Category	Kumite Male U12 +45kg							
3 Points	2 Points	1 Point	Score	1 Point	2 Points	3 Points		
			4 : 0					
Penatlity				Penatlity				
C1: C3, C2:				4:0	C1: C1, C2:			
WINNER				Total				

Decision of Superiority

Judge 1	Judge 2	Judge 3	Judge 4	Judge 5	Judge 6	Judge 7	Referee

Name _____

Signature _____

Lion Cup 2024 Luxembourg

297 Rue de Reckenthal L-2410 Strassen, LUXEMBOURG

Court Nr.	1	Pool	1	Date	2024-06-08	Field Position	58	
RED				BLUE				
NOC	KAYA FATIH (NED)			NOC	WAGENER MATHIS (LUX)			
Category	Kumite Male U12 +45kg							
3 Points	2 Points	1 Point	Score	1 Point	2 Points	3 Points		
			5 : 0					
Penatlity				Penatlity				
C1: C1, C2:				5:0	C1: C2, C2:			
WINNER				Total				

Decision of Superiority

Judge 1	Judge 2	Judge 3	Judge 4	Judge 5	Judge 6	Judge 7	Referee

Name _____

Signature _____

Lion Cup 2024 Luxembourg

297 Rue de Reckenthal L-2410 Strassen, LUXEMBOURG

Court Nr.	1	Pool	1	Date	2024-06-08	Field Position	61
RED				BLUE			
NOC	TASHCHUK OLEH (LUX)			NOC	KAYA FATIH (NED)		
Category	Kumite Male U12 +45kg						
3 Points	2 Points	1 Point	Score	1 Point	2 Points	3 Points	
			2 : 1				
Penatlity				Penatlity			
C1: HC, C2:				2:1	C1: , C2:		
WINNER				Total			

Decision of Superiority

Judge 1	Judge 2	Judge 3	Judge 4	Judge 5	Judge 6	Judge 7	Referee

Name _____

Signature _____

Lion Cup 2024 Luxembourg

297 Rue de Reckenthal L-2410 Strassen, LUXEMBOURG

Court Nr.	1	Pool	1	Date	2024-06-08	Field Position	62	
RED				BLUE				
NOC	FERREIRA PERDIGAO RODRIGO (LUX)			NOC	PUPKUS LUKAS (LUX)			
Category	Kumite Male U12 +45kg							
3 Points	2 Points	1 Point	Score	1 Point	2 Points	3 Points		
			0 : 1					
Penatlity				Penatlity				
C1: C1, C2:				0:1	C1: HC, C2:			
				Total	WINNER			

Decision of Superiority

Judge 1	Judge 2	Judge 3	Judge 4	Judge 5	Judge 6	Judge 7	Referee

Name _____

Signature _____

Lion Cup 2024 Luxembourg

297 Rue de Reckenthal L-2410 Strassen, LUXEMBOURG

Court Nr.	1	Pool	1	Date	2024-06-08	Field Position	63	
RED				BLUE				
NOC	TASHCHUK OLEH (LUX)			NOC	PUPKUS LUKAS (LUX)			
Category	Kumite Male U12 +45kg							
3 Points	2 Points	1 Point	Score	1 Point	2 Points	3 Points		
			1 : 0					
Penatlity				Penatlity				
C1: , C2:				1:0	C1: HC, C2:			
WINNER				Total				

Decision of Superiority

Judge 1	Judge 2	Judge 3	Judge 4	Judge 5	Judge 6	Judge 7	Referee

Name _____

Signature _____

Lion Cup 2024 Luxembourg

297 Rue de Reckenthal L-2410 Strassen, LUXEMBOURG

Court Nr.	1	Pool	1	Date	2024-06-08	Field Position	0
RED				BLUE			
NOC	ZENDELI MERITON (SUI)			NOC	KAYA FATIH (NED)		
Category	Kumite Male U12 +45kg						
3 Points	2 Points	1 Point	Score	1 Point	2 Points	3 Points	
			:				
Penatlity				Penatlity			
			Total				





Decision of Superiority

Judge 1	Judge 2	Judge 3	Judge 4	Judge 5	Judge 6	Judge 7	Referee

Name _____

Signature _____

Official Results

Kumite Male U12 +45kg			
1	TASHCHUK OLEH		LUX - LUXEMBOURG
2	PUPKUS LUKAS		LUX - LUXEMBOURG
3	FERREIRA PERDIGAO RODRIGO		LUX - LUXEMBOURG
3	ZENDELI MERITON		SUI - SWITZERLAND
5	KAYA FATIH		NED - NETHERLANDS

KUMITE MALE U12 -35KG

Lion Cup 2024 Luxembourg

ENTRIES BY WEIGHT CATEGORY
Kumite Male U12 -35kg

As of 8 JUN 2024

NOC Code	Gender	Name	Seeding
BEL	M	Bachiri Mehdi	
BEL	M	LUSALA HENOCK	
BEL	M	Palm Lucas	
BEL	M	QUARANTA SAVERIO	
ENG	M	Howard London-James	
FRA	M	Nana Fakhir	
FRA	M	SALMI Adam Youva	
FRA	M	ZEDEK Mokrane	
LUX	M	Anatole Michel	
LUX	M	Brugnoni Sacha	
LUX	M	Georges Jim	
LUX	M	Ketter Maurice	
LUX	M	MAGDA Marko	
LUX	M	Rollinger Henry	
LUX	M	Vatamaniuk Artem	
NED	M	Werner Stijn	
SUI	M	Ouk Jayden	

Kumite Male U12 -35kg

Lion Cup 2024 Luxembourg, 297 Rue de Reckenthal L-2410 Strassen, LUX

2024-06-08

Tatami
3 13:10

Pool
1/1

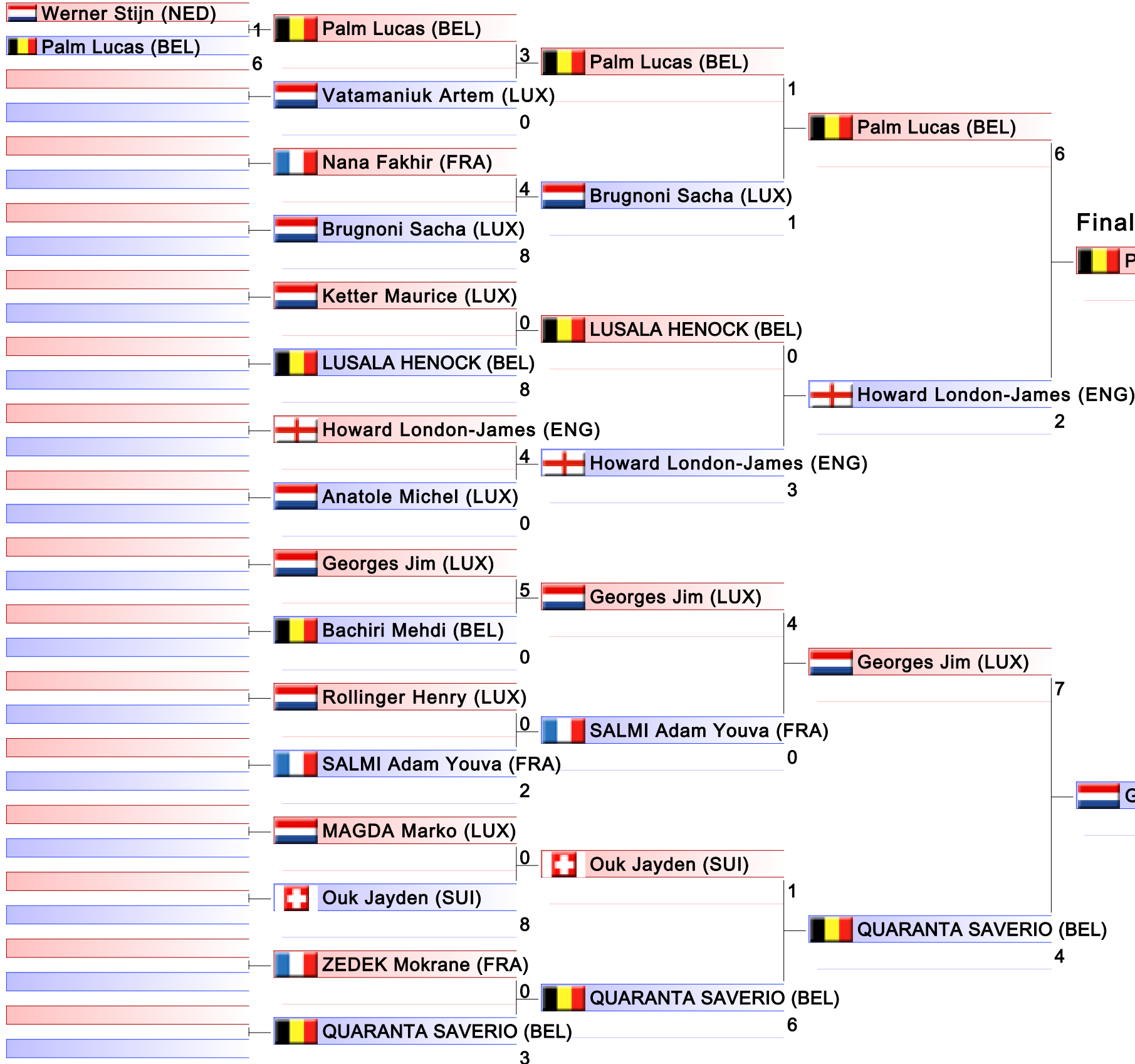

1. PALM LUCAS (BEL)
2. GEORGES JIM (LUX)
3. SALMI ADAM YOUVA (FRA)
3. BRUGNONI SACHA (LUX)
5. QUARANTA SAVERIO (BEL)
5. HOWARD LONDON-JAMES (ENG)
7. BACHIRI MEHDI (BEL)
7. WERNER STIJN (NED)

Kumite Male U12 -35kg

Lion Cup 2024 Luxembourg

2024-06-08

Tatami
3 13:50

Pool
1

(c)sportdata GmbH & Co KG 2000-2024 (2024-06-08 18:41) v 10.1.0 build 1 (2024-01-24 23:23 CET) License: Online_Event_ID-7672_LionCup2024Luxembourg (expire 2024-06-21)

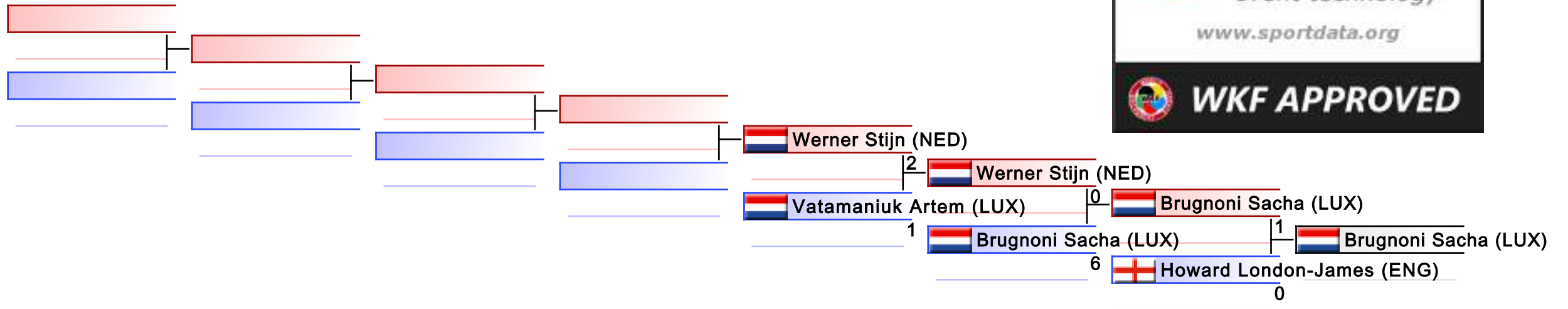

REPECHAGE: (1)

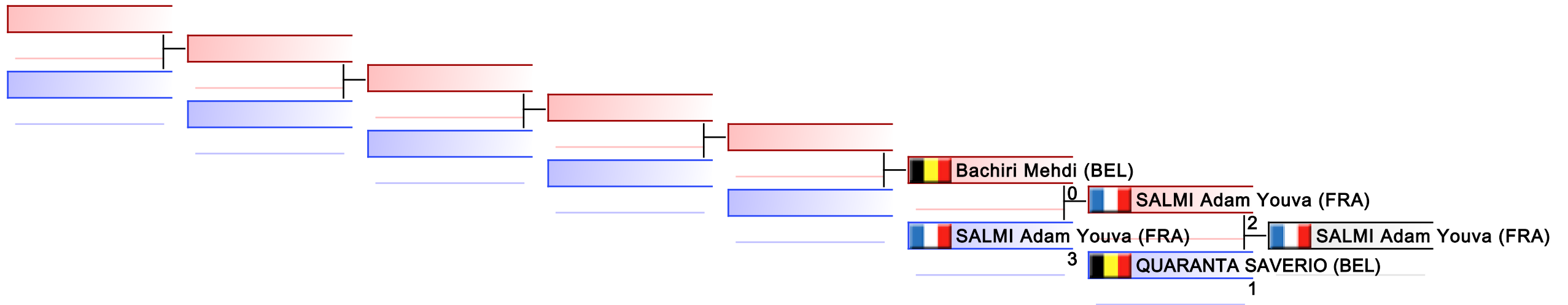

Lion Cup 2024 Luxembourg

297 Rue de Reckenthal L-2410 Strassen, LUXEMBOURG

Court Nr.	1	Pool	1	Date	2024-06-08	Field Position	33
RED				BLUE			
NOC	WERNER STIJN (NED)			NOC	PALM LUCAS (BEL)		
Category	Kumite Male U12 -35kg						
3 Points	2 Points	1 Point	Score	1 Point	2 Points	3 Points	
			1 : 6				
Penatlity				Penatlity			
C1: , C2:			1:6	C1: HC, C2:			
			Total	WINNER			

Decision of Superiority

Judge 1	Judge 2	Judge 3	Judge 4	Judge 5	Judge 6	Judge 7	Referee

Name _____

Signature _____

Lion Cup 2024 Luxembourg

297 Rue de Reckenthal L-2410 Strassen, LUXEMBOURG

Court Nr.	1	Pool	1	Date	2024-06-08	Field Position	49
RED				BLUE			
NOC	PALM LUCAS (BEL)			NOC	VATAMANIUK ARTEM (LUX)		
Category	Kumite Male U12 -35kg						
3 Points	2 Points	1 Point	Score	1 Point	2 Points	3 Points	
			3 : 0				
Penatlity				Penatlity			
C1: C2, C2:				3:0	C1: C2, C2:		
WINNER				Total			

Decision of Superiority

Judge 1	Judge 2	Judge 3	Judge 4	Judge 5	Judge 6	Judge 7	Referee

Name _____

Signature _____

Lion Cup 2024 Luxembourg

297 Rue de Reckenthal L-2410 Strassen, LUXEMBOURG

Court Nr.	1	Pool	1	Date	2024-06-08	Field Position	50	
RED				BLUE				
NOC	NANA FAKHIR (FRA)			NOC	BRUGNONI SACHA (LUX)			
Category	Kumite Male U12 -35kg							
3 Points	2 Points	1 Point	Score	1 Point	2 Points	3 Points		
			4 : 8					
Penatlity				Penatlity				
C1: HC, C2:				4:8	C1: HC, C2:			
				Total	WINNER			

Decision of Superiority

Judge 1	Judge 2	Judge 3	Judge 4	Judge 5	Judge 6	Judge 7	Referee

Name _____

Signature _____

Lion Cup 2024 Luxembourg

297 Rue de Reckenthal L-2410 Strassen, LUXEMBOURG

Court Nr.	1	Pool	1	Date	2024-06-08	Field Position	51
RED				BLUE			
NOC	KETTER MAURICE (LUX)			NOC	LUSALA HENOCK (BEL)		
Category	Kumite Male U12 -35kg						
3 Points	2 Points	1 Point	Score	1 Point	2 Points	3 Points	
			0 : 8				
Penatlity				Penatlity			
C1: C2, C2:				0:8	C1: , C2:		
				Total	WINNER		

Decision of Superiority

Judge 1	Judge 2	Judge 3	Judge 4	Judge 5	Judge 6	Judge 7	Referee

Name _____

Signature _____

Lion Cup 2024 Luxembourg

297 Rue de Reckenthal L-2410 Strassen, LUXEMBOURG

Court Nr.	1	Pool	1	Date	2024-06-08	Field Position	52	
RED				BLUE				
NOC	HOWARD LONDON-JAMES (ENG)			NOC	ANATOLE MICHEL (LUX)			
Category	Kumite Male U12 -35kg							
3 Points	2 Points	1 Point	Score	1 Point	2 Points	3 Points		
			4 : 0					
Penatlity				Penatlity				
C1: , C2:				4:0	C1: , C2:			
WINNER				Total				

Decision of Superiority

Judge 1	Judge 2	Judge 3	Judge 4	Judge 5	Judge 6	Judge 7	Referee

Name _____

Signature _____

Lion Cup 2024 Luxembourg

297 Rue de Reckenthal L-2410 Strassen, LUXEMBOURG

Court Nr.	1	Pool	1	Date	2024-06-08	Field Position	53	
RED				BLUE				
NOC	GEORGES JIM (LUX)			NOC	BACHIRI MEHDI (BEL)			
Category	Kumite Male U12 -35kg							
3 Points	2 Points	1 Point	Score	1 Point	2 Points	3 Points		
			5 : 0					
Penatlity				Penatlity				
C1: , C2:				5:0	C1: , C2:			
WINNER				Total				

Decision of Superiority

Judge 1	Judge 2	Judge 3	Judge 4	Judge 5	Judge 6	Judge 7	Referee

Name _____

Signature _____

Lion Cup 2024 Luxembourg

297 Rue de Reckenthal L-2410 Strassen, LUXEMBOURG

Court Nr.	1	Pool	1	Date	2024-06-08	Field Position	54
RED				BLUE			
NOC	ROLLINGER HENRY (LUX)			NOC	SALMI ADAM YOUVA (FRA)		
Category	Kumite Male U12 -35kg						
3 Points	2 Points	1 Point	Score	1 Point	2 Points	3 Points	
			0 : 2				
Penatlity				Penatlity			
C1: , C2:			0:2	C1: C1, C2:			
			Total	WINNER			

Decision of Superiority

Judge 1	Judge 2	Judge 3	Judge 4	Judge 5	Judge 6	Judge 7	Referee

Name _____

Signature _____

Lion Cup 2024 Luxembourg

297 Rue de Reckenthal L-2410 Strassen, LUXEMBOURG

Court Nr.	1	Pool	1	Date	2024-06-08	Field Position	55
RED				BLUE			
NOC	MAGDA MARKO (LUX)			NOC	OUK JAYDEN (SUI)		
Category	Kumite Male U12 -35kg						
3 Points	2 Points	1 Point	Score	1 Point	2 Points	3 Points	
			0 : 8				
Penatlity				Penatlity			
C1: , C2:			0:8	C1: , C2:			
			Total	WINNER			

Decision of Superiority

Judge 1	Judge 2	Judge 3	Judge 4	Judge 5	Judge 6	Judge 7	Referee

Name _____

Signature _____

Lion Cup 2024 Luxembourg

297 Rue de Reckenthal L-2410 Strassen, LUXEMBOURG

Court Nr.	1	Pool	1	Date	2024-06-08	Field Position	56	
RED				BLUE				
NOC	ZEDEK MOKRANE (FRA)			NOC	QUARANTA SAVERIO (BEL)			
Category	Kumite Male U12 -35kg							
3 Points	2 Points	1 Point	Score	1 Point	2 Points	3 Points		
			0 : 3					
Penatlity				Penatlity				
C1: C2, C2:				0:3	C1: HC, C2:			
				Total	WINNER			

Decision of Superiority

Judge 1	Judge 2	Judge 3	Judge 4	Judge 5	Judge 6	Judge 7	Referee

Name _____

Signature _____

Lion Cup 2024 Luxembourg

297 Rue de Reckenthal L-2410 Strassen, LUXEMBOURG

Court Nr.	1	Pool	1	Date	2024-06-08	Field Position	57
RED				BLUE			
NOC	PALM LUCAS (BEL)			NOC	BRUGNONI SACHA (LUX)		
Category	Kumite Male U12 -35kg						
3 Points	2 Points	1 Point	Score	1 Point	2 Points	3 Points	
			1 : 1				
Penatlity				Penatlity			
			1:1				
C1: , C2:				C1: , C2:			
WINNER			Total				

Decision of Superiority

Judge 1	Judge 2	Judge 3	Judge 4	Judge 5	Judge 6	Judge 7	Referee

Name _____

Signature _____

Lion Cup 2024 Luxembourg

297 Rue de Reckenthal L-2410 Strassen, LUXEMBOURG

Court Nr.	1	Pool	1	Date	2024-06-08	Field Position	58
RED				BLUE			
NOC	LUSALA HENOCK (BEL)			NOC	HOWARD LONDON-JAMES (ENG)		
Category	Kumite Male U12 -35kg						
3 Points	2 Points	1 Point	Score	1 Point	2 Points	3 Points	
			0 : 3				
Penatlity				Penatlity			
C1: , C2:				0:3	C1: C3, C2:		
				Total	WINNER		

Decision of Superiority

Judge 1	Judge 2	Judge 3	Judge 4	Judge 5	Judge 6	Judge 7	Referee

Name _____

Signature _____

Lion Cup 2024 Luxembourg

297 Rue de Reckenthal L-2410 Strassen, LUXEMBOURG

Court Nr.	1	Pool	1	Date	2024-06-08	Field Position	59	
RED				BLUE				
NOC	GEORGES JIM (LUX)			NOC	SALMI ADAM YOUVA (FRA)			
Category	Kumite Male U12 -35kg							
3 Points	2 Points	1 Point	Score	1 Point	2 Points	3 Points		
			4 : 0					
Penatlity				Penatlity				
C1: HC, C2:				4:0	C1: HC, C2:			
WINNER				Total				

Decision of Superiority

Judge 1	Judge 2	Judge 3	Judge 4	Judge 5	Judge 6	Judge 7	Referee

Name _____

Signature _____

Lion Cup 2024 Luxembourg

297 Rue de Reckenthal L-2410 Strassen, LUXEMBOURG

Court Nr.	1	Pool	1	Date	2024-06-08	Field Position	60	
RED				BLUE				
NOC	OUK JAYDEN (SUI)			NOC	QUARANTA SAVERIO (BEL)			
Category	Kumite Male U12 -35kg							
3 Points	2 Points	1 Point	Score	1 Point	2 Points	3 Points		
			1 : 6					
Penatlity				Penatlity				
C1: , C2:				1:6	C1: C3, C2:			
				Total	WINNER			

Decision of Superiority

Judge 1	Judge 2	Judge 3	Judge 4	Judge 5	Judge 6	Judge 7	Referee

Name _____

Signature _____

Lion Cup 2024 Luxembourg

297 Rue de Reckenthal L-2410 Strassen, LUXEMBOURG

Court Nr.	1	Pool	1	Date	2024-06-08	Field Position	61	
RED				BLUE				
NOC	PALM LUCAS (BEL)			NOC	HOWARD LONDON-JAMES (ENG)			
Category	Kumite Male U12 -35kg							
3 Points	2 Points	1 Point	Score	1 Point	2 Points	3 Points		
			6 : 2					
Penatlity				Penatlity				
C1: C1, C2:				6:2	C1: , C2:			
WINNER				Total				

Decision of Superiority

Judge 1	Judge 2	Judge 3	Judge 4	Judge 5	Judge 6	Judge 7	Referee

Name _____

Signature _____

Lion Cup 2024 Luxembourg

297 Rue de Reckenthal L-2410 Strassen, LUXEMBOURG

Court Nr.	1	Pool	1	Date	2024-06-08	Field Position	62	
RED				BLUE				
NOC	GEORGES JIM (LUX)			NOC	QUARANTA SAVERIO (BEL)			
Category	Kumite Male U12 -35kg							
3 Points	2 Points	1 Point	Score	1 Point	2 Points	3 Points		
			7 : 4					
Penatlity				Penatlity				
C1: C2, C2:				7:4	C1: C2, C2:			
WINNER				Total				

Decision of Superiority

Judge 1	Judge 2	Judge 3	Judge 4	Judge 5	Judge 6	Judge 7	Referee

Name _____

Signature _____

Lion Cup 2024 Luxembourg

297 Rue de Reckenthal L-2410 Strassen, LUXEMBOURG

Court Nr.	1	Pool	1	Date	2024-06-08	Field Position	63
RED				BLUE			
NOC	PALM LUCAS (BEL)			NOC	GEORGES JIM (LUX)		
Category	Kumite Male U12 -35kg						
3 Points	2 Points	1 Point	Score	1 Point	2 Points	3 Points	
			5 : 2				
Penatlity				Penatlity			
C1: HC, C2:				5:2	C1: , C2:		
WINNER				Total			

Decision of Superiority

Judge 1	Judge 2	Judge 3	Judge 4	Judge 5	Judge 6	Judge 7	Referee

Name _____

Signature _____

Lion Cup 2024 Luxembourg

297 Rue de Reckenthal L-2410 Strassen, LUXEMBOURG

Court Nr.	1	Pool	1	Date	2024-06-08	Field Position	0	
RED				BLUE				
NOC	BRUGNONI SACHA (LUX)			NOC	HOWARD LONDON-JAMES (ENG)			
Category	Kumite Male U12 -35kg							
3 Points	2 Points	1 Point	Score	1 Point	2 Points	3 Points		
			1 : 0					
Penatlity				Penatlity				
C1: C1, C2:				1:0	C1: C2, C2:			
WINNER				Total				

Decision of Superiority

Judge 1	Judge 2	Judge 3	Judge 4	Judge 5	Judge 6	Judge 7	Referee

Name _____

Signature _____

Lion Cup 2024 Luxembourg

297 Rue de Reckenthal L-2410 Strassen, LUXEMBOURG

Court Nr.	1	Pool	1	Date	2024-06-08	Field Position	2
RED				BLUE			
NOC	WERNER STIJN (NED)			NOC	BRUGNONI SACHA (LUX)		
Category	Kumite Male U12 -35kg						
3 Points	2 Points	1 Point	Score	1 Point	2 Points	3 Points	
			0 : 6				
Penatlity				Penatlity			
C1: , C2:				0:6	C1: C1, C2:		
				Total	WINNER		

Decision of Superiority

Judge 1	Judge 2	Judge 3	Judge 4	Judge 5	Judge 6	Judge 7	Referee

Name _____

Signature _____

Lion Cup 2024 Luxembourg

297 Rue de Reckenthal L-2410 Strassen, LUXEMBOURG

Court Nr.	1	Pool	1	Date	2024-06-08	Field Position	4
RED				BLUE			
NOC	WERNER STIJN (NED)			NOC	VATAMANIUK ARTEM (LUX)		
Category	Kumite Male U12 -35kg						
3 Points	2 Points	1 Point	Score	1 Point	2 Points	3 Points	
			:				
Penatlity				Penatlity			
			Total				

Decision of Superiority

Judge 1	Judge 2	Judge 3	Judge 4	Judge 5	Judge 6	Judge 7	Referee

Name _____

Signature _____

Lion Cup 2024 Luxembourg

297 Rue de Reckenthal L-2410 Strassen, LUXEMBOURG

Court Nr.	2	Pool	2	Date	2024-06-08	Field Position	0	
RED				BLUE				
NOC	SALMI ADAM YOUVA (FRA)			NOC	QUARANTA SAVERIO (BEL)			
Category	Kumite Male U12 -35kg							
3 Points	2 Points	1 Point	Score	1 Point	2 Points	3 Points		
			2 : 1					
Penatlity				Penatlity				
C1: HC, C2:				2:1	C1: C1, C2:			
WINNER				Total				

Decision of Superiority

Judge 1	Judge 2	Judge 3	Judge 4	Judge 5	Judge 6	Judge 7	Referee

Name _____

Signature _____

Lion Cup 2024 Luxembourg

297 Rue de Reckenthal L-2410 Strassen, LUXEMBOURG

Court Nr.	2	Pool	2	Date	2024-06-08	Field Position	2
RED				BLUE			
NOC	BACHIRI MEHDI (BEL)			NOC	SALMI ADAM YOUVA (FRA)		
Category	Kumite Male U12 -35kg						
3 Points	2 Points	1 Point	Score	1 Point	2 Points	3 Points	
			0 : 3				
Penatlity				Penatlity			
C1: , C2:				0:3	C1: , C2:		
				Total	WINNER		

Decision of Superiority

Judge 1	Judge 2	Judge 3	Judge 4	Judge 5	Judge 6	Judge 7	Referee

Name _____

Signature _____

Lion Cup 2024 Luxembourg - 2024-06-07

Official Results

Kumite Male U12 -35kg			
1	PALM LUCAS		BEL - BELGIUM
2	GEORGES JIM		LUX - LUXEMBOURG
3	SALMI ADAM YOUVA		FRA - FRANCE
3	BRUGNONI SACHA		LUX - LUXEMBOURG
5	QUARANTA SAVERIO		BEL - BELGIUM
5	HOWARD LONDON-JAMES		ENG - ENGLAND
7	BACHIRI MEHDI		BEL - BELGIUM
7	WERNER STIJN		NED - NETHERLANDS
9	VATAMANIUK ARTEM		LUX - LUXEMBOURG

KUMITE MALE U12 -45KG

Lion Cup 2024 Luxembourg

ENTRIES BY WEIGHT CATEGORY
Kumite Male U12 -45kg

As of 8 JUN 2024

NOC Code	Gender	Name	Seeding
AUT	M	Anderl Lionel	
BEL	M	Bentaya Nathan	
BEL	M	Boulogne Thibaut	
BEL	M	Fadili Telio	
BEL	M	Mehadhebi Rami	
FRA	M	Tchaldaev Abdoul	
GER	M	Becker Tom	
LUX	M	De Rubeis Leonardo	
LUX	M	Lichtfous Jeremy	
LUX	M	Mineiro Jairo	
LUX	M	PARASCHIV Mihai	
LUX	M	ROMAN Andrea	
NED	M	Errahouti Safouan	
NED	M	Gotwalt Jesaja	
NED	M	Narcicegi Tan	
NED	M	Tomson Max	
NED	M	Volders Joshua	
SUI	M	Carvalho Pereira Rafael	
SUI	M	Delianidis Ioannis	
SUI	M	Hachem Elie	
SUI	M	Maillard Timéo	
SUI	M	Meier Nikita	

Kumite Male U12 -45kg

Lion Cup 2024 Luxembourg, 297 Rue de Reckenthal L-2410 Strassen, LUX

2024-06-08

Tatami
4 13:10

Pool
1 / 1

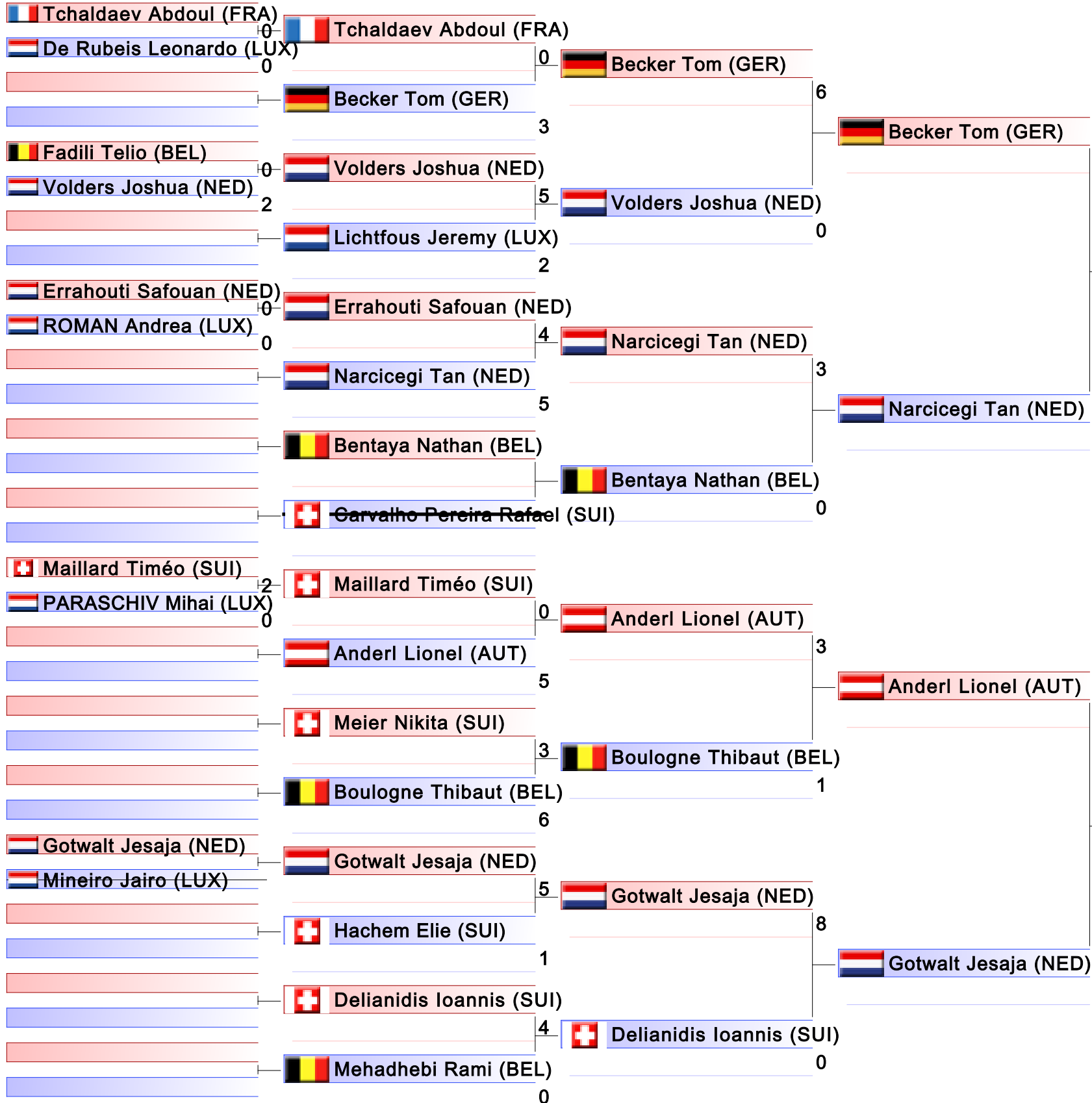

Final

1. GOTWALT JESAJA (NED)
2. BECKER TOM (GER)
3. TCHALDAEV ABDOUL (FRA)
3. ANDERL LIONEL (AUT)
5. NARCICEGI TAN (NED)
5. DELIANIDIS IOANNIS (SUI)
7. VOLDERS JOSHUA (NED)
7. HACHEM ELIE (SUI)

Kumite Male U12 -45kg

Lion Cup 2024 Luxembourg

2024-06-08

Tatami
4 14:10

Pool
1

(c)sportdata GmbH & Co KG 2000-2024 (2024-06-08 18:41) v 10.1.0 build 1 (2024-01-24 23:23 CET) License: Online_Event_ID-7672_LionCup2024Luxembourg (expire 2024-06-21)

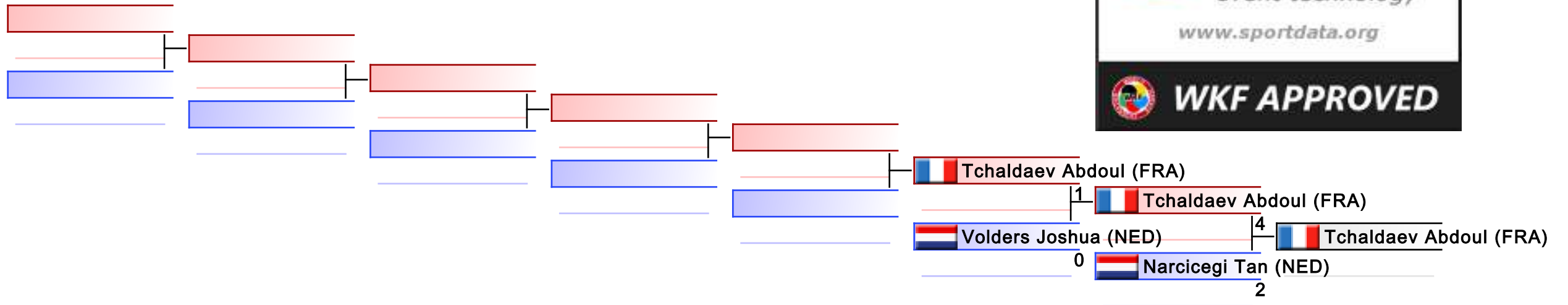

REPECHAGE: (1)

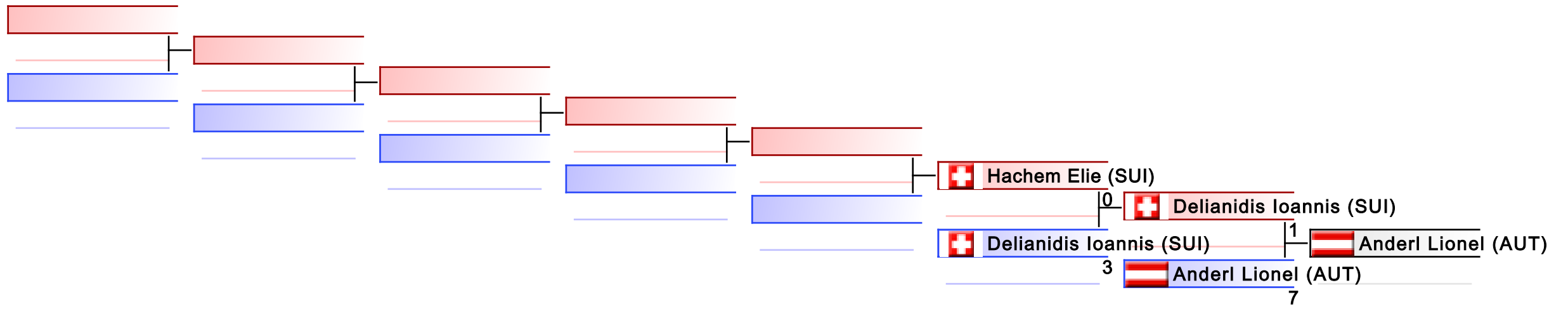

Lion Cup 2024 Luxembourg

297 Rue de Reckenthal L-2410 Strassen, LUXEMBOURG

Court Nr.	1	Pool	1	Date	2024-06-08	Field Position	33
RED				BLUE			
NOC	TCHALDAEV ABDOUL (FRA)			NOC	DE RUBEIS LEONARDO (LUX)		
Category	Kumite Male U12 -45kg						
3 Points	2 Points	1 Point	Score	1 Point	2 Points	3 Points	
			0 : 0				
Penatlity				Penatlity			
C1: C1, C2:				0:0	C1: C1, C2:		
WINNER				Total			

Decision of Superiority

Judge 1	Judge 2	Judge 3	Judge 4	Judge 5	Judge 6	Judge 7	Referee

Name _____

Signature _____

Lion Cup 2024 Luxembourg

297 Rue de Reckenthal L-2410 Strassen, LUXEMBOURG

Court Nr.	1	Pool	1	Date	2024-06-08	Field Position	35	
RED				BLUE				
NOC	FADILI TELIO (BEL)			NOC	VOLDERS JOSHUA (NED)			
Category	Kumite Male U12 -45kg							
3 Points	2 Points	1 Point	Score	1 Point	2 Points	3 Points		
			0 : 2					
Penatlity				Penatlity				
C1: C2, C2:				0:2	C1: HC, C2:			
				Total	WINNER			

Decision of Superiority

Judge 1	Judge 2	Judge 3	Judge 4	Judge 5	Judge 6	Judge 7	Referee

Name _____

Signature _____

Lion Cup 2024 Luxembourg

297 Rue de Reckenthal L-2410 Strassen, LUXEMBOURG

Court Nr.	1	Pool	1	Date	2024-06-08	Field Position	37
RED				BLUE			
NOC	ERRAHOUTI SAFOUAN (NED)			NOC	ROMAN ANDREA (LUX)		
Category	Kumite Male U12 -45kg						
3 Points	2 Points	1 Point	Score	1 Point	2 Points	3 Points	
			0 : 0				
Penatlity				Penatlity			
C1: C1, C2:				0:0	C1: , C2:		
WINNER				Total			

Decision of Superiority

Judge 1	Judge 2	Judge 3	Judge 4	Judge 5	Judge 6	Judge 7	Referee

Name _____

Signature _____

Lion Cup 2024 Luxembourg

297 Rue de Reckenthal L-2410 Strassen, LUXEMBOURG

Court Nr.	1	Pool	1	Date	2024-06-08	Field Position	41	
RED				BLUE				
NOC	MAILLARD TIMO (SUI)			NOC	PARASCHIV MIHAI (LUX)			
Category	Kumite Male U12 -45kg							
3 Points	2 Points	1 Point	Score	1 Point	2 Points	3 Points		
			2 : 0					
Penatlity				Penatlity				
C1: , C2:				2:0	C1: C1, C2:			
WINNER				Total				

Decision of Superiority

Judge 1	Judge 2	Judge 3	Judge 4	Judge 5	Judge 6	Judge 7	Referee

Name _____

Signature _____

Lion Cup 2024 Luxembourg

297 Rue de Reckenthal L-2410 Strassen, LUXEMBOURG

Court Nr.	1	Pool	1	Date	2024-06-08	Field Position	49	
RED				BLUE				
NOC	TCHALDAEV ABDOUL (FRA)			NOC	BECKER TOM (GER)			
Category	Kumite Male U12 -45kg							
3 Points	2 Points	1 Point	Score	1 Point	2 Points	3 Points		
			0 : 3					
Penatlity				Penatlity				
C1: HC, C2:				0:3	C1: HC, C2:			
				Total	WINNER			

Decision of Superiority

Judge 1	Judge 2	Judge 3	Judge 4	Judge 5	Judge 6	Judge 7	Referee

Name _____

Signature _____

Lion Cup 2024 Luxembourg

297 Rue de Reckenthal L-2410 Strassen, LUXEMBOURG

Court Nr.	1	Pool	1	Date	2024-06-08	Field Position	50
RED				BLUE			
NOC	VOLDERS JOSHUA (NED)			NOC	LICHTFOUS JEREMY (LUX)		
Category	Kumite Male U12 -45kg						
3 Points	2 Points	1 Point	Score	1 Point	2 Points	3 Points	
			5 : 2				
Penatlity				Penatlity			
C1: C1, C2:			5:2	C1: C3, C2:			
WINNER			Total				

Decision of Superiority

Judge 1	Judge 2	Judge 3	Judge 4	Judge 5	Judge 6	Judge 7	Referee

Name _____

Signature _____

Lion Cup 2024 Luxembourg

297 Rue de Reckenthal L-2410 Strassen, LUXEMBOURG

Court Nr.	1	Pool	1	Date	2024-06-08	Field Position	51	
RED				BLUE				
NOC	ERRAHOUTI SAFOUAN (NED)			NOC	NARCICEGI TAN (NED)			
Category	Kumite Male U12 -45kg							
3 Points	2 Points	1 Point	Score	1 Point	2 Points	3 Points		
			4 : 5					
Penatlity				Penatlity				
C1: , C2:				4:5	C1: C1, C2:			
				Total	WINNER			

Decision of Superiority

Judge 1	Judge 2	Judge 3	Judge 4	Judge 5	Judge 6	Judge 7	Referee

Name _____

Signature _____

Lion Cup 2024 Luxembourg

297 Rue de Reckenthal L-2410 Strassen, LUXEMBOURG

Court Nr.	1	Pool	1	Date	2024-06-08	Field Position	53	
RED				BLUE				
NOC	MAILLARD TIMO (SUI)			NOC	ANDERL LIONEL (AUT)			
Category	Kumite Male U12 -45kg							
3 Points	2 Points	1 Point	Score	1 Point	2 Points	3 Points		
			0 : 5					
Penatlity				Penatlity				
C1: , C2:				0:5	C1: C1, C2:			
				Total	WINNER			

Decision of Superiority

Judge 1	Judge 2	Judge 3	Judge 4	Judge 5	Judge 6	Judge 7	Referee

Name _____

Signature _____

Lion Cup 2024 Luxembourg

297 Rue de Reckenthal L-2410 Strassen, LUXEMBOURG

Court Nr.	1	Pool	1	Date	2024-06-08	Field Position	54
RED				BLUE			
NOC	MEIER NIKITA (SUI)			NOC	BOULOGNE THIBAUT (BEL)		
Category	Kumite Male U12 -45kg						
3 Points	2 Points	1 Point	Score	1 Point	2 Points	3 Points	
			3 : 6				
Penatlity				Penatlity			
C1: H, C2:				3:6	C1: , C2:		
				Total	WINNER		

Decision of Superiority

Judge 1	Judge 2	Judge 3	Judge 4	Judge 5	Judge 6	Judge 7	Referee

Name _____

Signature _____

Lion Cup 2024 Luxembourg

297 Rue de Reckenthal L-2410 Strassen, LUXEMBOURG

Court Nr.	1	Pool	1	Date	2024-06-08	Field Position	55
RED				BLUE			
NOC	GOTWALT JESAJA (NED)			NOC	HACHEM ELIE (SUI)		
Category	Kumite Male U12 -45kg						
3 Points	2 Points	1 Point	Score	1 Point	2 Points	3 Points	
			5 : 1				
Penatlity				Penatlity			
C1: C1, C2:				5:1	C1: , C2:		
WINNER				Total			

Decision of Superiority

Judge 1	Judge 2	Judge 3	Judge 4	Judge 5	Judge 6	Judge 7	Referee

Name _____

Signature _____

Lion Cup 2024 Luxembourg

297 Rue de Reckenthal L-2410 Strassen, LUXEMBOURG

Court Nr.	1	Pool	1	Date	2024-06-08	Field Position	56	
RED				BLUE				
NOC	DELIANIDIS IOANNIS (SUI)			NOC	MEHADHEBI RAMI (BEL)			
Category	Kumite Male U12 -45kg							
3 Points	2 Points	1 Point	Score	1 Point	2 Points	3 Points		
			4 : 0					
Penatlity				Penatlity				
C1: C2, C2:				4:0	C1: C3, C2:			
WINNER				Total				

Decision of Superiority

Judge 1	Judge 2	Judge 3	Judge 4	Judge 5	Judge 6	Judge 7	Referee

Name _____

Signature _____

Lion Cup 2024 Luxembourg

297 Rue de Reckenthal L-2410 Strassen, LUXEMBOURG

Court Nr.	1	Pool	1	Date	2024-06-08	Field Position	57
RED				BLUE			
NOC	BECKER TOM (GER)			NOC	VOLDERS JOSHUA (NED)		
Category	Kumite Male U12 -45kg						
3 Points	2 Points	1 Point	Score	1 Point	2 Points	3 Points	
			6 : 0				
Penatlity					Penatlity		
C1: C1, C2:				6:0	C1: , C2:		
WINNER				Total			

Decision of Superiority

Judge 1	Judge 2	Judge 3	Judge 4	Judge 5	Judge 6	Judge 7	Referee

Name _____

Signature _____

Lion Cup 2024 Luxembourg

297 Rue de Reckenthal L-2410 Strassen, LUXEMBOURG

Court Nr.	1	Pool	1	Date	2024-06-08	Field Position	58
RED				BLUE			
NOC	NARCICEGI TAN (NED)			NOC	BENTAYA NATHAN (BEL)		
Category	Kumite Male U12 -45kg						
3 Points	2 Points	1 Point	Score	1 Point	2 Points	3 Points	
			3 : 0				
Penatlity				Penatlity			
C1: C1, C2:			3:0	C1: C2, C2:			
WINNER			Total				

Decision of Superiority

Judge 1	Judge 2	Judge 3	Judge 4	Judge 5	Judge 6	Judge 7	Referee

Name _____

Signature _____

Lion Cup 2024 Luxembourg

297 Rue de Reckenthal L-2410 Strassen, LUXEMBOURG

Court Nr.	1	Pool	1	Date	2024-06-08	Field Position	59
RED				BLUE			
NOC	ANDERL LIONEL (AUT)			NOC	BOULOGNE THIBAUT (BEL)		
Category	Kumite Male U12 -45kg						
3 Points	2 Points	1 Point	Score	1 Point	2 Points	3 Points	
			3 : 1				
Penatlity				Penatlity			
C1: C1, C2:				3:1	C1: , C2:		
WINNER				Total			

Decision of Superiority

Judge 1	Judge 2	Judge 3	Judge 4	Judge 5	Judge 6	Judge 7	Referee

Name _____

Signature _____

Lion Cup 2024 Luxembourg

297 Rue de Reckenthal L-2410 Strassen, LUXEMBOURG

Court Nr.	1	Pool	1	Date	2024-06-08	Field Position	60	
RED				BLUE				
NOC	GOTWALT JESAJA (NED)			NOC	DELIANIDIS IOANNIS (SUI)			
Category	Kumite Male U12 -45kg							
3 Points	2 Points	1 Point	Score	1 Point	2 Points	3 Points		
			8 : 0					
Penatlity				Penatlity				
C1: HC, C2:				8:0	C1: C1, C2:			
WINNER				Total				

Decision of Superiority

Judge 1	Judge 2	Judge 3	Judge 4	Judge 5	Judge 6	Judge 7	Referee

Name _____

Signature _____

Lion Cup 2024 Luxembourg

297 Rue de Reckenthal L-2410 Strassen, LUXEMBOURG

Court Nr.	1	Pool	1	Date	2024-06-08	Field Position	61	
RED				BLUE				
NOC	BECKER TOM (GER)			NOC	NARCICEGI TAN (NED)			
Category	Kumite Male U12 -45kg							
3 Points	2 Points	1 Point	Score	1 Point	2 Points	3 Points		
			5 : 1					
Penatlity				Penatlity				
C1: C2, C2:				5:1	C1: C1, C2:			
WINNER				Total				

Decision of Superiority

Judge 1	Judge 2	Judge 3	Judge 4	Judge 5	Judge 6	Judge 7	Referee

Name _____

Signature _____

Lion Cup 2024 Luxembourg

297 Rue de Reckenthal L-2410 Strassen, LUXEMBOURG

Court Nr.	1	Pool	1	Date	2024-06-08	Field Position	62
RED				BLUE			
NOC	ANDERL LIONEL (AUT)			NOC	GOTWALT JESAJA (NED)		
Category	Kumite Male U12 -45kg						
3 Points	2 Points	1 Point	Score	1 Point	2 Points	3 Points	
			0 : 3				
Penatlity				Penatlity			
C1: , C2:				0:3	C1: C2, C2:		
				Total	WINNER		

Decision of Superiority

Judge 1	Judge 2	Judge 3	Judge 4	Judge 5	Judge 6	Judge 7	Referee

Name _____

Signature _____

Lion Cup 2024 Luxembourg

297 Rue de Reckenthal L-2410 Strassen, LUXEMBOURG

Court Nr.	1	Pool	1	Date	2024-06-08	Field Position	63	
RED				BLUE				
NOC	BECKER TOM (GER)			NOC	GOTWALT JESAJA (NED)			
Category	Kumite Male U12 -45kg							
3 Points	2 Points	1 Point	Score	1 Point	2 Points	3 Points		
			2 : 8					
Penatlity				Penatlity				
C1: C1, C2:				2:8	C1: , C2:			
				Total	WINNER			

Decision of Superiority

Judge 1	Judge 2	Judge 3	Judge 4	Judge 5	Judge 6	Judge 7	Referee

Name _____

Signature _____

Lion Cup 2024 Luxembourg

297 Rue de Reckenthal L-2410 Strassen, LUXEMBOURG

Court Nr.	1	Pool	1	Date	2024-06-08	Field Position	0	
RED				BLUE				
NOC	TCHALDAEV ABDOUL (FRA)			NOC	NARCICEGI TAN (NED)			
Category	Kumite Male U12 -45kg							
3 Points	2 Points	1 Point	Score	1 Point	2 Points	3 Points		
			4 : 2					
Penatlity				Penatlity				
C1: C3, C2:				4:2	C1: , C2:			
WINNER				Total				

Decision of Superiority

Judge 1	Judge 2	Judge 3	Judge 4	Judge 5	Judge 6	Judge 7	Referee

Name _____

Signature _____

Lion Cup 2024 Luxembourg

297 Rue de Reckenthal L-2410 Strassen, LUXEMBOURG

Court Nr.	1	Pool	1	Date	2024-06-08	Field Position	2
RED				BLUE			
NOC	TCHALDAEV ABDOUL (FRA)			NOC	VOLDERS JOSHUA (NED)		
Category	Kumite Male U12 -45kg						
3 Points	2 Points	1 Point	Score	1 Point	2 Points	3 Points	
			:				
Penatlity				Penatlity			
			Total				

Decision of Superiority

Judge 1	Judge 2	Judge 3	Judge 4	Judge 5	Judge 6	Judge 7	Referee

Name _____

Signature _____

Lion Cup 2024 Luxembourg

297 Rue de Reckenthal L-2410 Strassen, LUXEMBOURG

Court Nr.	2	Pool	2	Date	2024-06-08	Field Position	0
RED				BLUE			
NOC	DELIANIDIS IOANNIS (SUI)			NOC	ANDERL LIONEL (AUT)		
Category	Kumite Male U12 -45kg						
3 Points	2 Points	1 Point	Score	1 Point	2 Points	3 Points	
			1 : 7				
Penatlity					Penatlity		
C1: H, C2:				1:7	C1: , C2:		
				Total	WINNER		

Decision of Superiority

Judge 1	Judge 2	Judge 3	Judge 4	Judge 5	Judge 6	Judge 7	Referee

Name _____

Signature _____

Lion Cup 2024 Luxembourg

297 Rue de Reckenthal L-2410 Strassen, LUXEMBOURG

Court Nr.	2	Pool	2	Date	2024-06-08	Field Position	2
RED				BLUE			
NOC	HACHEM ELIE (SUI)			NOC	DELIANIDIS IOANNIS (SUI)		
Category	Kumite Male U12 -45kg						
3 Points	2 Points	1 Point	Score	1 Point	2 Points	3 Points	
			0 : 3				
Penatlity				Penatlity			
C1: C2, C2:				0:3	C1: C3, C2:		
				Total	WINNER		

Decision of Superiority

Judge 1	Judge 2	Judge 3	Judge 4	Judge 5	Judge 6	Judge 7	Referee

Name _____

Signature _____

Official Results

Kumite Male U12 -45kg			
1	GOTWALT JESAJA		NED - NETHERLANDS
2	BECKER TOM		GER - GERMANY
3	TCHALDAEV ABDOUL		FRA - FRANCE
3	ANDERL LIONEL		AUT - AUSTRIA
5	NARCICEGI TAN		NED - NETHERLANDS
5	DELIANIDIS IOANNIS		SUI - SWITZERLAND
7	VOLDERS JOSHUA		NED - NETHERLANDS
7	HACHEM ELIE		SUI - SWITZERLAND

KUMITE MALE U14 +50KG

Lion Cup 2024 Luxembourg

ENTRIES BY WEIGHT CATEGORY
Kumite Male U14 +50kg

As of 8 JUN 2024

NOC Code	Gender	Name	Seeding
BEL	M	Chakhter Amin	
BEL	M	Disalvo Samuel	
BEL	M	Leistedt Oliver	
BEL	M	Mehadhebi Amir	
LUX	M	DEFENSE Dario	
LUX	M	Knarov Ambroise	
NED	M	Bohoudi Ilyas	
NED	M	Bohoudi Issam	
NED	M	Mulder Stan	
NED	M	van de Nes Dinand	
POL	M	Kamornik Dzmitry	
SUI	M	Berisha Dren	
SUI	M	Giess Thierry	
SUI	M	Gloor Leon	

Kumite Male U14 +50kg

Lion Cup 2024 Luxembourg, 297 Rue de Reckenthal L-2410 Strassen, LUX

2024-06-08

Tatami
4 14:40

Pool
1/1

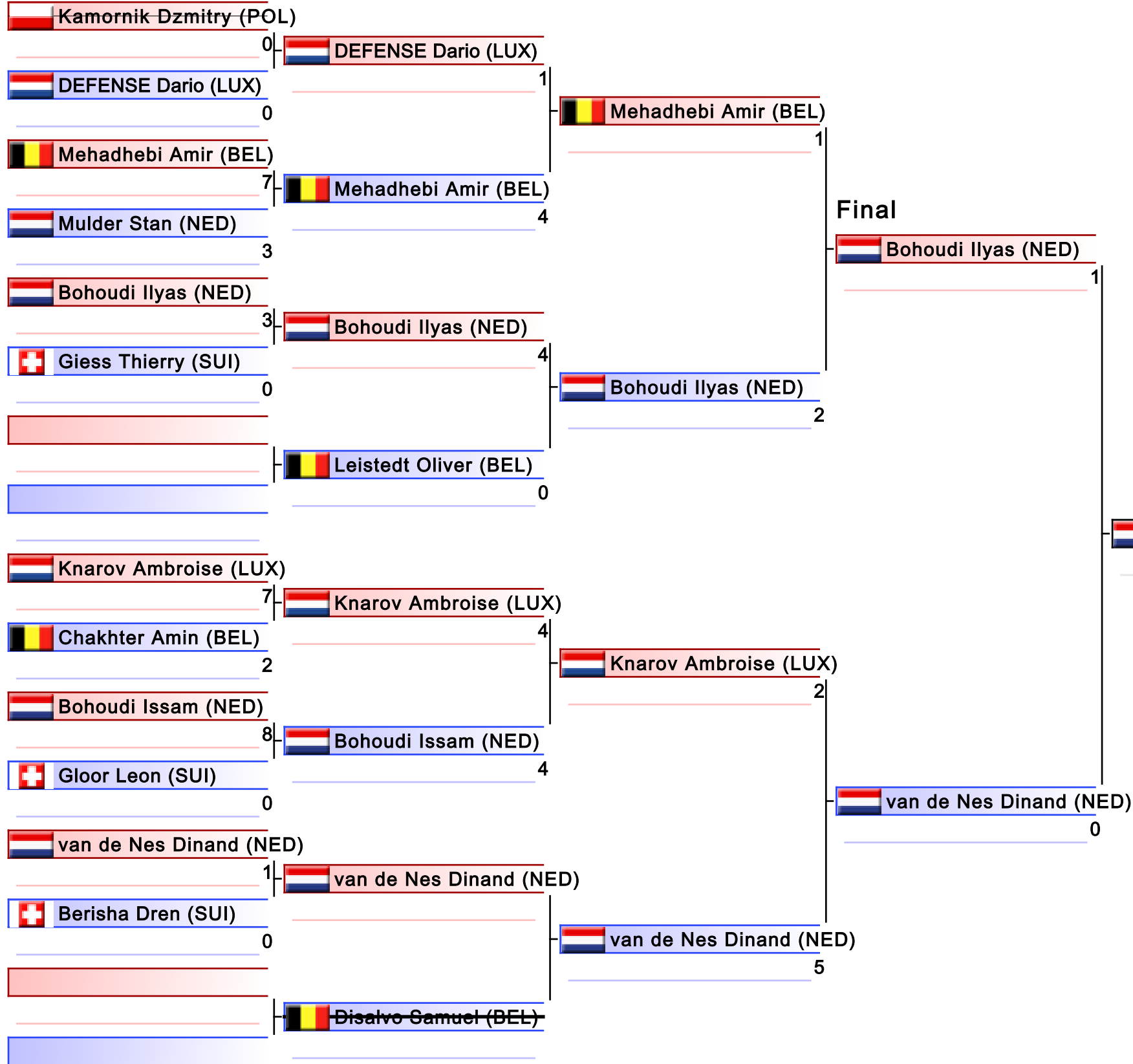

1. BOHOUDI ILYAS (NED)
2. VAN DE NES DINAND (NED)
3. KNAROV AMBROISE (LUX)
3. MEHADHEBI AMIR (BEL)
5. BERISHA DREN (SUI)
5. LEISTEDT OLIVER (BEL)
7. GIESS THIERRY (SUI)

Kumite Male U14 +50kg

Lion Cup 2024 Luxembourg

2024-06-08

Tatami
4 15:25

Pool
1

(c)sportdata GmbH & Co KG 2000-2024 (2024-06-08 18:41) v 10.1.0 build 1 (2024-01-24 23:23 CET) License: Online_Event_ID-7672_LionCup2024Luxembourg (expire 2024-06-21)

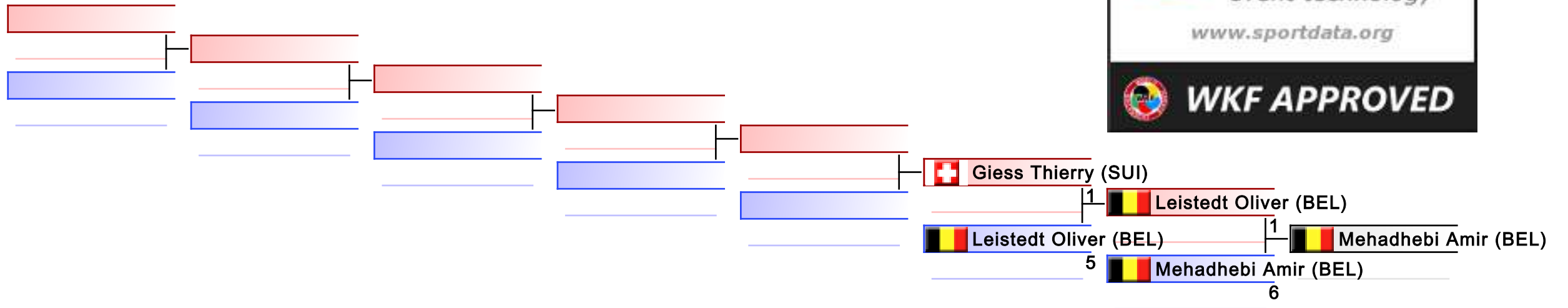

REPECHAGE: (1)

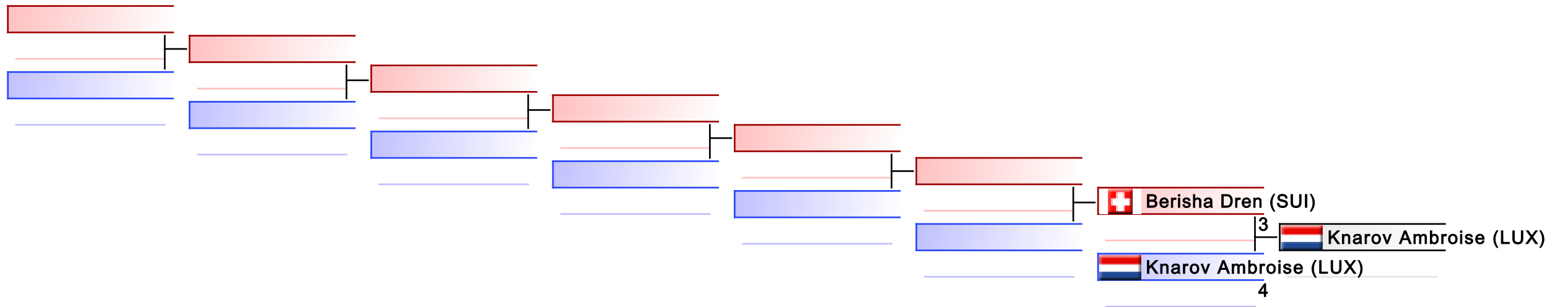

Lion Cup 2024 Luxembourg

297 Rue de Reckenthal L-2410 Strassen, LUXEMBOURG

Court Nr.	1	Pool	1	Date	2024-06-08	Field Position	50	
RED				BLUE				
NOC	MEHADHEBI AMIR (BEL)			NOC	MULDER STAN (NED)			
Category	Kumite Male U14 +50kg							
3 Points	2 Points	1 Point	Score	1 Point	2 Points	3 Points		
			7 : 3					
Penatlity				Penatlity				
C1: C3, C2:				7:3	C1: C3, C2:			
WINNER				Total				

Decision of Superiority

Judge 1	Judge 2	Judge 3	Judge 4	Judge 5	Judge 6	Judge 7	Referee

Name _____

Signature _____

Lion Cup 2024 Luxembourg

297 Rue de Reckenthal L-2410 Strassen, LUXEMBOURG

Court Nr.	1	Pool	1	Date	2024-06-08	Field Position	51
RED				BLUE			
NOC	BOHOUDI ILYAS (NED)			NOC	GIESS THIERRY (SUI)		
Category	Kumite Male U14 +50kg						
3 Points	2 Points	1 Point	Score	1 Point	2 Points	3 Points	
			3 : 0				
Penatlity				Penatlity			
C1: , C2:				3:0	C1: , C2:		
WINNER				Total			

Decision of Superiority

Judge 1	Judge 2	Judge 3	Judge 4	Judge 5	Judge 6	Judge 7	Referee

Name _____

Signature _____

Lion Cup 2024 Luxembourg

297 Rue de Reckenthal L-2410 Strassen, LUXEMBOURG

Court Nr.	1	Pool	1	Date	2024-06-08	Field Position	53
RED				BLUE			
NOC	KNAROV AMBROISE (LUX)			NOC	CHAKHTER AMIN (BEL)		
Category	Kumite Male U14 +50kg						
3 Points	2 Points	1 Point	Score	1 Point	2 Points	3 Points	
			7 : 2				
Penatlity				Penatlity			
C1: C1, C2:				7:2	C1: , C2:		
WINNER				Total			

Decision of Superiority

Judge 1	Judge 2	Judge 3	Judge 4	Judge 5	Judge 6	Judge 7	Referee

Name _____

Signature _____

Lion Cup 2024 Luxembourg

297 Rue de Reckenthal L-2410 Strassen, LUXEMBOURG

Court Nr.	1	Pool	1	Date	2024-06-08	Field Position	54
RED				BLUE			
NOC	BOHOUDI ISSAM (NED)			NOC	GLOOR LEON (SUI)		
Category	Kumite Male U14 +50kg						
3 Points	2 Points	1 Point	Score	1 Point	2 Points	3 Points	
			8 : 0				
Penatlity				Penatlity			
C1: C1, C2:				8:0	C1: C1, C2:		
WINNER				Total			

Decision of Superiority

Judge 1	Judge 2	Judge 3	Judge 4	Judge 5	Judge 6	Judge 7	Referee

Name _____

Signature _____

Lion Cup 2024 Luxembourg

297 Rue de Reckenthal L-2410 Strassen, LUXEMBOURG

Court Nr.	1	Pool	1	Date	2024-06-08	Field Position	55
RED				BLUE			
NOC	VAN DE NES DINAND (NED)			NOC	BERISHA DREN (SUI)		
Category	Kumite Male U14 +50kg						
3 Points	2 Points	1 Point	Score	1 Point	2 Points	3 Points	
			1 : 0				
Penatlity				Penatlity			
C1: HC, C2:			1:0	C1: C2, C2:			
WINNER			Total				

Decision of Superiority

Judge 1	Judge 2	Judge 3	Judge 4	Judge 5	Judge 6	Judge 7	Referee

Name _____

Signature _____

Lion Cup 2024 Luxembourg

297 Rue de Reckenthal L-2410 Strassen, LUXEMBOURG

Court Nr.	1	Pool	1	Date	2024-06-08	Field Position	57	
RED				BLUE				
NOC	DEFENSE DARIO (LUX)			NOC	MEHADHEBI AMIR (BEL)			
Category	Kumite Male U14 +50kg							
3 Points	2 Points	1 Point	Score	1 Point	2 Points	3 Points		
			1 : 4					
Penatlity				Penatlity				
C1: , C2:				1:4	C1: C1, C2:			
				Total	WINNER			

Decision of Superiority

Judge 1	Judge 2	Judge 3	Judge 4	Judge 5	Judge 6	Judge 7	Referee

Name _____

Signature _____

Lion Cup 2024 Luxembourg

297 Rue de Reckenthal L-2410 Strassen, LUXEMBOURG

Court Nr.	1	Pool	1	Date	2024-06-08	Field Position	58	
RED				BLUE				
NOC	BOHOUDI ILYAS (NED)			NOC	LEISTEDT OLIVER (BEL)			
Category	Kumite Male U14 +50kg							
3 Points	2 Points	1 Point	Score	1 Point	2 Points	3 Points		
			4 : 0					
Penatlity				Penatlity				
C1: , C2:				4:0	C1: , C2:			
WINNER				Total				

Decision of Superiority

Judge 1	Judge 2	Judge 3	Judge 4	Judge 5	Judge 6	Judge 7	Referee

Name _____

Signature _____

Lion Cup 2024 Luxembourg

297 Rue de Reckenthal L-2410 Strassen, LUXEMBOURG

Court Nr.	1	Pool	1	Date	2024-06-08	Field Position	59
RED				BLUE			
NOC	KNAROV AMBROISE (LUX)			NOC	BOHOUDI ISSAM (NED)		
Category	Kumite Male U14 +50kg						
3 Points	2 Points	1 Point	Score	1 Point	2 Points	3 Points	
			4 : 4				
Penatlity				Penatlity			
C1: , C2:				4:4	C1: HC, C2:		
WINNER				Total			

Decision of Superiority

Judge 1	Judge 2	Judge 3	Judge 4	Judge 5	Judge 6	Judge 7	Referee

Name _____

Signature _____

Lion Cup 2024 Luxembourg

297 Rue de Reckenthal L-2410 Strassen, LUXEMBOURG

Court Nr.	1	Pool	1	Date	2024-06-08	Field Position	61
RED				BLUE			
NOC	MEHADHEBI AMIR (BEL)			NOC	BOHOUDI ILYAS (NED)		
Category	Kumite Male U14 +50kg						
3 Points	2 Points	1 Point	Score	1 Point	2 Points	3 Points	
			1 : 2				
Penatlity					Penatlity		
C1: C1, C2:				1:2	C1: C2, C2:		
				Total	WINNER		

Decision of Superiority

Judge 1	Judge 2	Judge 3	Judge 4	Judge 5	Judge 6	Judge 7	Referee

Name _____

Signature _____

Lion Cup 2024 Luxembourg

297 Rue de Reckenthal L-2410 Strassen, LUXEMBOURG

Court Nr.	1	Pool	1	Date	2024-06-08	Field Position	62	
RED				BLUE				
NOC	KNAROV AMBROISE (LUX)			NOC	VAN DE NES DINAND (NED)			
Category	Kumite Male U14 +50kg							
3 Points	2 Points	1 Point	Score	1 Point	2 Points	3 Points		
			2 : 5					
Penatlity				Penatlity				
C1: C2, C2:				2:5	C1: C1, C2:			
				Total	WINNER			

Decision of Superiority

Judge 1	Judge 2	Judge 3	Judge 4	Judge 5	Judge 6	Judge 7	Referee

Name _____

Signature _____

Lion Cup 2024 Luxembourg

297 Rue de Reckenthal L-2410 Strassen, LUXEMBOURG

Court Nr.	1	Pool	1	Date	2024-06-08	Field Position	63	
RED				BLUE				
NOC	BOHOUDI ILYAS (NED)			NOC	VAN DE NES DINAND (NED)			
Category	Kumite Male U14 +50kg							
3 Points	2 Points	1 Point	Score	1 Point	2 Points	3 Points		
			1 : 0					
Penatlity				Penatlity				
C1: HC, C2:				1:0	C1: C1, C2:			
WINNER				Total				

Decision of Superiority

Judge 1	Judge 2	Judge 3	Judge 4	Judge 5	Judge 6	Judge 7	Referee

Name _____

Signature _____

Lion Cup 2024 Luxembourg

297 Rue de Reckenthal L-2410 Strassen, LUXEMBOURG

Court Nr.	1	Pool	1	Date	2024-06-08	Field Position	0
RED				BLUE			
NOC	LEISTEDT OLIVER (BEL)			NOC	MEHADHEBI AMIR (BEL)		
Category	Kumite Male U14 +50kg						
3 Points	2 Points	1 Point	Score	1 Point	2 Points	3 Points	
			1 : 6				
Penatlity				Penatlity			
C1: , C2:				1:6	C1: C1, C2:		
				Total	WINNER		

Decision of Superiority

Judge 1	Judge 2	Judge 3	Judge 4	Judge 5	Judge 6	Judge 7	Referee

Name _____

Signature _____

Lion Cup 2024 Luxembourg

297 Rue de Reckenthal L-2410 Strassen, LUXEMBOURG

Court Nr.	1	Pool	1	Date	2024-06-08	Field Position	2
RED				BLUE			
NOC	GIESS THIERRY (SUI)			NOC	LEISTEDT OLIVER (BEL)		
Category	Kumite Male U14 +50kg						
3 Points	2 Points	1 Point	Score	1 Point	2 Points	3 Points	
			:				
Penatlity				Penatlity			
			Total				

Decision of Superiority

Judge 1	Judge 2	Judge 3	Judge 4	Judge 5	Judge 6	Judge 7	Referee

Name _____

Signature _____

Lion Cup 2024 Luxembourg

297 Rue de Reckenthal L-2410 Strassen, LUXEMBOURG

Court Nr.	2	Pool	2	Date	2024-06-08	Field Position	0
RED				BLUE			
NOC	BERISHA DREN (SUI)			NOC	KNAROV AMBROISE (LUX)		
Category	Kumite Male U14 +50kg						
3 Points	2 Points	1 Point	Score	1 Point	2 Points	3 Points	
			3 : 4				
Penatlity				Penatlity			
C1: , C2:			3:4	C1: C1, C2:			
			Total	WINNER			

Decision of Superiority

Judge 1	Judge 2	Judge 3	Judge 4	Judge 5	Judge 6	Judge 7	Referee

Name _____

Signature _____

Official Results

Kumite Male U14 +50kg			
1	BOHOUDI ILYAS		NED - NETHERLANDS
2	VAN DE NES DINAND		NED - NETHERLANDS
3	KNAROV AMBROISE		LUX - LUXEMBOURG
3	MEHADHEBI AMIR		BEL - BELGIUM
5	BERISHA DREN		SUI - SWITZERLAND
5	LEISTEDT OLIVER		BEL - BELGIUM
7	GIESS THIERRY		SUI - SWITZERLAND

KUMITE MALE U14 -40KG

Lion Cup 2024 Luxembourg

ENTRIES BY WEIGHT CATEGORY
Kumite Male U14 -40kg

As of 8 JUN 2024

NOC Code	Gender	Name	Seeding
BEL	M	Azibous Yanis	
BEL	M	Bergiers Teano	
BEL	M	BOSCOLO NATHAN	
BEL	M	Dernoncourt Sofiane	
BEL	M	Guetari Oussama	
BEL	M	TARCHI Sedki	
BEL	M	Van Den Nieuwenhuijzen Vince	
BEL	M	Zakhnini Imrane	
ENG	M	Bridges Harry	
ENG	M	Julian Oscar	
FRA	M	SALMI Anis Tahar	
GER	M	Becker Jonas	
LUX	M	Kieffer Tom	
NED	M	Arbaj Badr Din	
NED	M	Rondhuis Dex	
POL	M	Pilat Maksym	
SUI	M	Sivarasalingam Laarushan	
SUI	M	Stein Kilian Johan	
SUI	M	Vuong Levin	

Kumite Male U14 -40kg

Lion Cup 2024 Luxembourg, 297 Rue de Reckenthal L-2410 Strassen, LUX

2024-06-08

Tatami
1 13:10

Pool
1/1

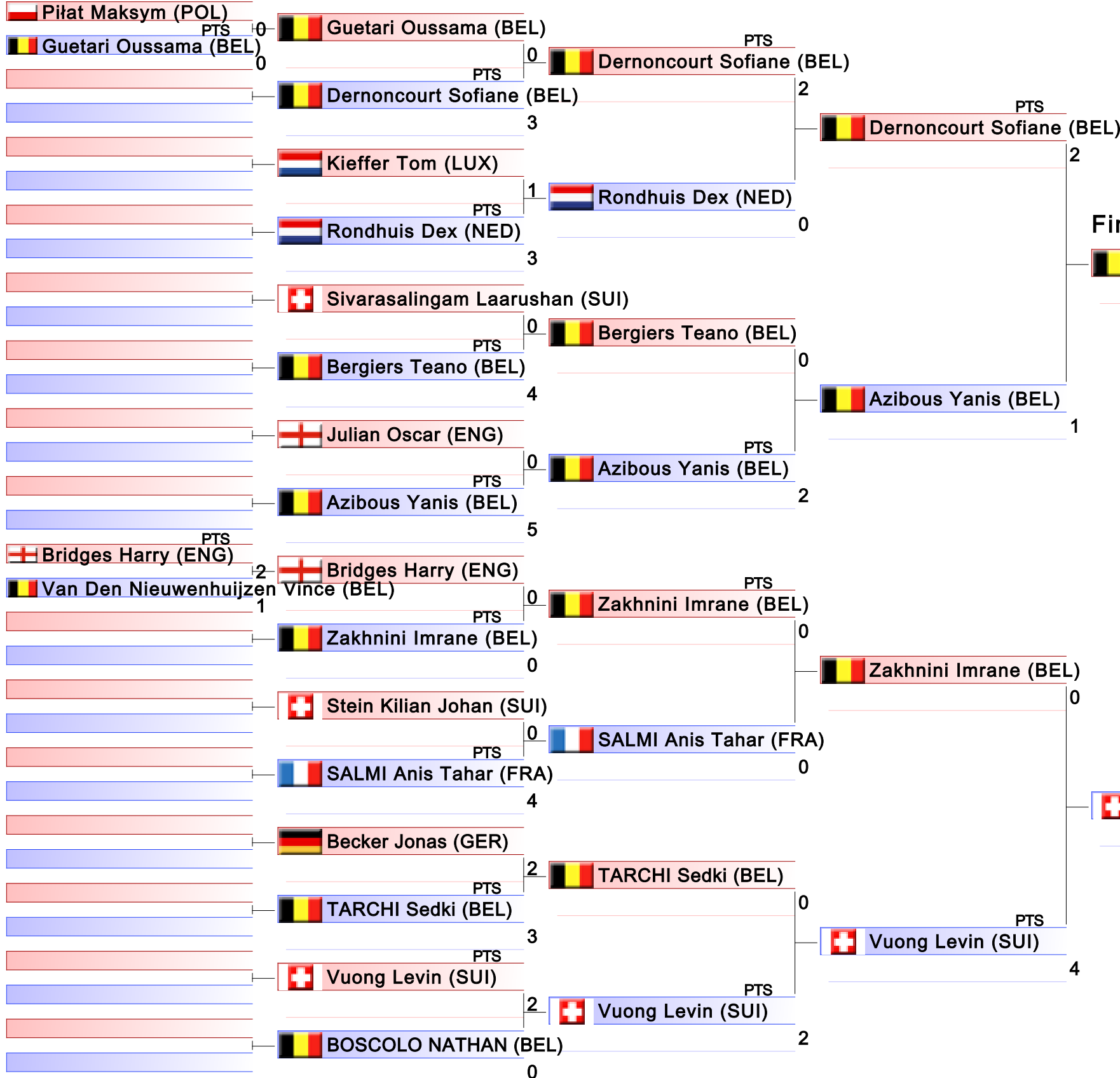

1. DERNONCOURT SOFIANE (BEL)
2. VUONG LEVIN (SUI)
3. AZIBOUS YANIS (BEL)
3. BOSCOLO NATHAN (BEL)
5. GUETARI OUSSAMA (BEL)
5. ZAKHNINI IMRANE (BEL)
7. RONDHUIS DEX (NED)
7. TARCHI SEDKI (BEL)

Kumite Male U14 -40kg

Lion Cup 2024 Luxembourg

2024-06-08

Tatami
1 14:10

Pool
1

(c)sportdata GmbH & Co KG 2000-2024 (2024-06-08 18:41) v 10.1.0 build 1 (2024-01-24 23:23 CET) License: Online_Event_ID-7672_LionCup2024Luxembourg (expire 2024-06-21)

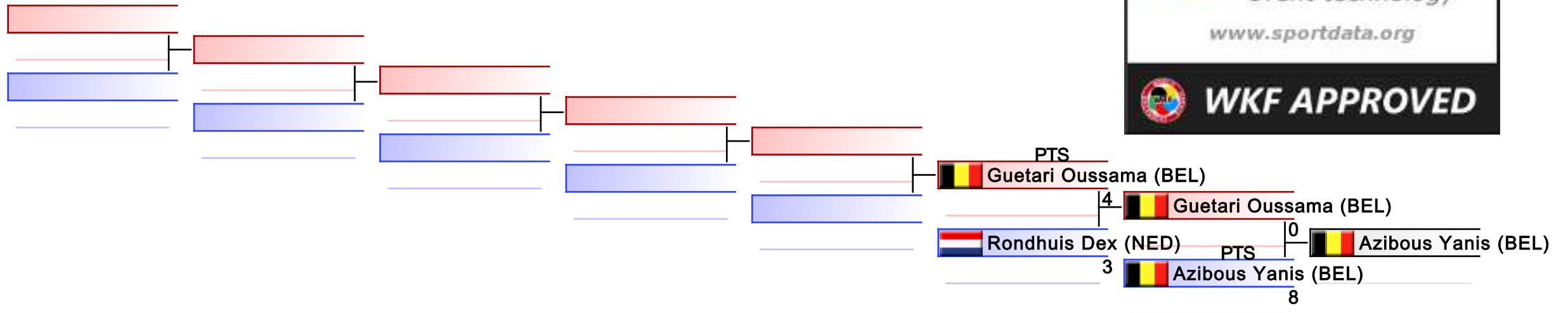

REPECHAGE: (1)

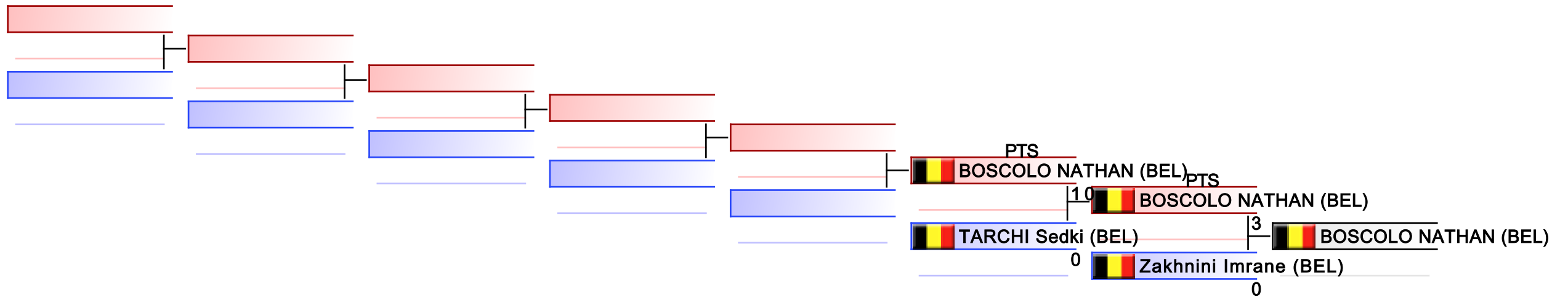

Lion Cup 2024 Luxembourg

297 Rue de Reckenthal L-2410 Strassen, LUXEMBOURG

Court Nr.	1	Pool	1	Date	2024-06-08	Field Position	33
RED				BLUE			
NOC	PIAT MAKSYM (POL)			NOC	GUETARI OUSSAMA (BEL)		
Category	Kumite Male U14 -40kg						
3 Points	2 Points	1 Point	Score	1 Point	2 Points	3 Points	
			0 : 0				
Penatlity					Penatlity		
C1: , C2:				0:0	C1: , C2:		
				Total	WINNER		

PTS

Decision of Superiority

Judge 1	Judge 2	Judge 3	Judge 4	Judge 5	Judge 6	Judge 7	Referee

Name _____

Signature _____

Lion Cup 2024 Luxembourg

297 Rue de Reckenthal L-2410 Strassen, LUXEMBOURG

Court Nr.	1	Pool	1	Date	2024-06-08	Field Position	41
RED				BLUE			
NOC	BRIDGES HARRY (ENG)			NOC	VAN DEN NIEUWENHUIJZEN VINCE (BEL)		
Category	Kumite Male U14 -40kg						
3 Points	2 Points	1 Point	Score	1 Point	2 Points	3 Points	
			2 : 1				
Penatlity				Penatlity			
C1: HC, C2:				2:1	C1: , C2:		
WINNER				Total			

PTS

Decision of Superiority

Judge 1	Judge 2	Judge 3	Judge 4	Judge 5	Judge 6	Judge 7	Referee

Name _____

Signature _____

Lion Cup 2024 Luxembourg

297 Rue de Reckenthal L-2410 Strassen, LUXEMBOURG

Court Nr.	1	Pool	1	Date	2024-06-08	Field Position	49
RED				BLUE			
NOC	GUETARI OUSSAMA (BEL)			NOC	DERNONCOURT SOFIANE (BEL)		
Category	Kumite Male U14 -40kg						
3 Points	2 Points	1 Point	Score	1 Point	2 Points	3 Points	
			0 : 3				
Penatlity					Penatlity		
C1: HC, C2:				0:3	C1: C3, C2:		
				Total	WINNER		

PTS

Decision of Superiority

Judge 1	Judge 2	Judge 3	Judge 4	Judge 5	Judge 6	Judge 7	Referee

Name _____

Signature _____

Lion Cup 2024 Luxembourg

297 Rue de Reckenthal L-2410 Strassen, LUXEMBOURG

Court Nr.	1	Pool	1	Date	2024-06-08	Field Position	50
RED				BLUE			
NOC	KIEFFER TOM (LUX)			NOC	RONDHUIS DEX (NED)		
Category	Kumite Male U14 -40kg						
3 Points	2 Points	1 Point	Score	1 Point	2 Points	3 Points	
			1 : 3				
Penatlity				Penatlity			
C1: , C2:				1:3	C1: , C2:		
				Total	WINNER		

PTS

Decision of Superiority

Judge 1	Judge 2	Judge 3	Judge 4	Judge 5	Judge 6	Judge 7	Referee

Name _____

Signature _____

Lion Cup 2024 Luxembourg

297 Rue de Reckenthal L-2410 Strassen, LUXEMBOURG

Court Nr.	1	Pool	1	Date	2024-06-08	Field Position	51
RED				BLUE			
NOC	SIVARASALINGAM LAARUSHAN (SUI)			NOC	BERGIERS TEANO (BEL)		
Category	Kumite Male U14 -40kg						
3 Points	2 Points	1 Point	Score	1 Point	2 Points	3 Points	
			0 : 4				
Penatlity					Penatlity		
C1: C1, C2:				0:4	C1: HC, C2:		
				Total	WINNER		

PTS

Decision of Superiority

Judge 1	Judge 2	Judge 3	Judge 4	Judge 5	Judge 6	Judge 7	Referee

Name _____

Signature _____

Lion Cup 2024 Luxembourg

297 Rue de Reckenthal L-2410 Strassen, LUXEMBOURG

Court Nr.	1	Pool	1	Date	2024-06-08	Field Position	52
RED				BLUE			
NOC	JULIAN OSCAR (ENG)			NOC	AZIBOUS YANIS (BEL)		
Category	Kumite Male U14 -40kg						
3 Points	2 Points	1 Point	Score	1 Point	2 Points	3 Points	
			0 : 5				
Penatlity				Penatlity			
C1: C2, C2:			0:5	C1: C1, C2:			
			Total	WINNER			

PTS

Decision of Superiority

Judge 1	Judge 2	Judge 3	Judge 4	Judge 5	Judge 6	Judge 7	Referee

Name _____

Signature _____

Lion Cup 2024 Luxembourg

297 Rue de Reckenthal L-2410 Strassen, LUXEMBOURG

Court Nr.	1	Pool	1	Date	2024-06-08	Field Position	53
RED				BLUE			
NOC	BRIDGES HARRY (ENG)			NOC	ZAKHNINI IMRANE (BEL)		
Category	Kumite Male U14 -40kg						
3 Points	2 Points	1 Point	Score	1 Point	2 Points	3 Points	
			0 : 0				
Penatlity				Penatlity			
C1: C1, C2:				0:0	C1: C1, C2:		
				Total	WINNER		

PTS

Decision of Superiority

Judge 1	Judge 2	Judge 3	Judge 4	Judge 5	Judge 6	Judge 7	Referee

Name _____

Signature _____

Lion Cup 2024 Luxembourg

297 Rue de Reckenthal L-2410 Strassen, LUXEMBOURG

Court Nr.	1	Pool	1	Date	2024-06-08	Field Position	54
RED				BLUE			
NOC	STEIN KILIAN JOHAN (SUI)			NOC	SALMI ANIS TAHAR (FRA)		
Category	Kumite Male U14 -40kg						
3 Points	2 Points	1 Point	Score	1 Point	2 Points	3 Points	
			0 : 4				
Penatlity				Penatlity			
C1: , C2:			0:4	C1: , C2:			
			Total	WINNER			

PTS

Decision of Superiority

Judge 1	Judge 2	Judge 3	Judge 4	Judge 5	Judge 6	Judge 7	Referee

Name _____

Signature _____

Lion Cup 2024 Luxembourg

297 Rue de Reckenthal L-2410 Strassen, LUXEMBOURG

Court Nr.	1	Pool	1	Date	2024-06-08	Field Position	55	
RED				BLUE				
NOC	BECKER JONAS (GER)			NOC	TARCHI SEDKI (BEL)			
Category	Kumite Male U14 -40kg							
3 Points	2 Points	1 Point	Score	1 Point	2 Points	3 Points		
			2 : 3					
Penatlity				Penatlity				
C1: , C2:				2:3	C1: , C2:			
				Total	WINNER			

PTS

Decision of Superiority

Judge 1	Judge 2	Judge 3	Judge 4	Judge 5	Judge 6	Judge 7	Referee

Name _____

Signature _____

Lion Cup 2024 Luxembourg

297 Rue de Reckenthal L-2410 Strassen, LUXEMBOURG

Court Nr.	1	Pool	1	Date	2024-06-08	Field Position	56	
RED				BLUE				
NOC	VUONG LEVIN (SUI)			NOC	BOSCOLO NATHAN (BEL)			
Category	Kumite Male U14 -40kg							
3 Points	2 Points	1 Point	Score	1 Point	2 Points	3 Points		
			2 : 0					
Penatlity				Penatlity				
C1: HC, C2:				2:0	C1: C2, C2:			
WINNER				Total				

PTS

Decision of Superiority

Judge 1	Judge 2	Judge 3	Judge 4	Judge 5	Judge 6	Judge 7	Referee

Name _____

Signature _____

Lion Cup 2024 Luxembourg

297 Rue de Reckenthal L-2410 Strassen, LUXEMBOURG

Court Nr.	1	Pool	1	Date	2024-06-08	Field Position	57	
RED				BLUE				
NOC	DERNONCOURT SOFIANE (BEL)			NOC	RONDHUIS DEX (NED)			
Category	Kumite Male U14 -40kg							
3 Points	2 Points	1 Point	Score	1 Point	2 Points	3 Points		
			2 : 0					
Penatlity				Penatlity				
C1: C1, C2:				2:0	C1: C2, C2:			
WINNER				Total				

PTS

Decision of Superiority

Judge 1	Judge 2	Judge 3	Judge 4	Judge 5	Judge 6	Judge 7	Referee

Name _____

Signature _____

Lion Cup 2024 Luxembourg

297 Rue de Reckenthal L-2410 Strassen, LUXEMBOURG

Court Nr.	1	Pool	1	Date	2024-06-08	Field Position	58	
RED				BLUE				
NOC	BERGIERS TEANO (BEL)			NOC	AZIBOUS YANIS (BEL)			
Category	Kumite Male U14 -40kg							
3 Points	2 Points	1 Point	Score	1 Point	2 Points	3 Points		
			0 : 2					
Penatlity				Penatlity				
C1: HC, C2:				0:2	C1: HC, C2:			
				Total	WINNER			

PTS

Decision of Superiority

Judge 1	Judge 2	Judge 3	Judge 4	Judge 5	Judge 6	Judge 7	Referee

Name _____

Signature _____

Lion Cup 2024 Luxembourg

297 Rue de Reckenthal L-2410 Strassen, LUXEMBOURG

Court Nr.	1	Pool	1	Date	2024-06-08	Field Position	59
RED				BLUE			
NOC	ZAKHNINI IMRANE (BEL)			NOC	SALMI ANIS TAHAR (FRA)		
Category	Kumite Male U14 -40kg						
3 Points	2 Points	1 Point	Score	1 Point	2 Points	3 Points	
			0 : 0				
Penatlity				Penatlity			
C1: , C2:				0:0	C1: , C2:		
WINNER				Total			

PTS

Decision of Superiority

Judge 1	Judge 2	Judge 3	Judge 4	Judge 5	Judge 6	Judge 7	Referee

Name _____

Signature _____

Lion Cup 2024 Luxembourg

297 Rue de Reckenthal L-2410 Strassen, LUXEMBOURG

Court Nr.	1	Pool	1	Date	2024-06-08	Field Position	60
RED				BLUE			
NOC	TARCHI SEDKI (BEL)			NOC	VUONG LEVIN (SUI)		
Category	Kumite Male U14 -40kg						
3 Points	2 Points	1 Point	Score	1 Point	2 Points	3 Points	
			0 : 2				
Penatlity				Penatlity			
C1: C2, C2:				0:2	C1: , C2:		
				Total	WINNER		

PTS

Decision of Superiority

Judge 1	Judge 2	Judge 3	Judge 4	Judge 5	Judge 6	Judge 7	Referee

Name _____

Signature _____

Lion Cup 2024 Luxembourg

297 Rue de Reckenthal L-2410 Strassen, LUXEMBOURG

Court Nr.	1	Pool	1	Date	2024-06-08	Field Position	61
RED				BLUE			
NOC	DERNONCOURT SOFIANE (BEL)			NOC	AZIBOUS YANIS (BEL)		
Category	Kumite Male U14 -40kg						
3 Points	2 Points	1 Point	Score	1 Point	2 Points	3 Points	
			2 : 1				
Penatlity					Penatlity		
C1: C2, C2:				2:1	C1: C1, C2:		
WINNER				Total			

PTS

Decision of Superiority

Judge 1	Judge 2	Judge 3	Judge 4	Judge 5	Judge 6	Judge 7	Referee

Name _____

Signature _____

Lion Cup 2024 Luxembourg

297 Rue de Reckenthal L-2410 Strassen, LUXEMBOURG

Court Nr.	1	Pool	1	Date	2024-06-08	Field Position	62
RED				BLUE			
NOC	ZAKHNINI IMRANE (BEL)			NOC	VUONG LEVIN (SUI)		
Category	Kumite Male U14 -40kg						
3 Points	2 Points	1 Point	Score	1 Point	2 Points	3 Points	
			0 : 4				
Penatlity				Penatlity			
C1: C2, C2:				0:4	C1: C3, C2:		
				Total	WINNER		

PTS

Decision of Superiority

Judge 1	Judge 2	Judge 3	Judge 4	Judge 5	Judge 6	Judge 7	Referee

Name _____

Signature _____

Lion Cup 2024 Luxembourg

297 Rue de Reckenthal L-2410 Strassen, LUXEMBOURG

Court Nr.	1	Pool	1	Date	2024-06-08	Field Position	63
RED				BLUE			
NOC	DERNONCOURT SOFIANE (BEL)			NOC	VUONG LEVIN (SUI)		
Category	Kumite Male U14 -40kg						
3 Points	2 Points	1 Point	Score	1 Point	2 Points	3 Points	
			1 : 1				
Penatlity					Penatlity		
C1: C2, C2:				1:1	C1: , C2:		
WINNER				Total			

PTS

Decision of Superiority

Judge 1	Judge 2	Judge 3	Judge 4	Judge 5	Judge 6	Judge 7	Referee

Name _____

Signature _____

Lion Cup 2024 Luxembourg

297 Rue de Reckenthal L-2410 Strassen, LUXEMBOURG

Court Nr.	1	Pool	1	Date	2024-06-08	Field Position	0
RED				BLUE			
NOC	GUETARI OUSSAMA (BEL)			NOC	AZIBOUS YANIS (BEL)		
Category	Kumite Male U14 -40kg						
3 Points	2 Points	1 Point	Score	1 Point	2 Points	3 Points	
			0 : 8				
Penatlity				Penatlity			
C1: , C2:				0:8	C1: C2, C2:		
				Total	WINNER		

PTS

Decision of Superiority

Judge 1	Judge 2	Judge 3	Judge 4	Judge 5	Judge 6	Judge 7	Referee

Name _____

Signature _____

Lion Cup 2024 Luxembourg

297 Rue de Reckenthal L-2410 Strassen, LUXEMBOURG

Court Nr.	1	Pool	1	Date	2024-06-08	Field Position	2
RED				BLUE			
NOC	GUETARI OUSSAMA (BEL)			NOC	RONDHUIS DEX (NED)		
Category	Kumite Male U14 -40kg						
3 Points	2 Points	1 Point	Score	1 Point	2 Points	3 Points	
			:				
Penatlity				Penatlity			
			Total				

Decision of Superiority

Judge 1	Judge 2	Judge 3	Judge 4	Judge 5	Judge 6	Judge 7	Referee

Name _____

Signature _____

Lion Cup 2024 Luxembourg

297 Rue de Reckenthal L-2410 Strassen, LUXEMBOURG

Court Nr.	2	Pool	2	Date	2024-06-08	Field Position	0
RED				BLUE			
NOC	BOSCOLO NATHAN (BEL)			NOC	ZAKHNINI IMRANE (BEL)		
Category	Kumite Male U14 -40kg						
3 Points	2 Points	1 Point	Score	1 Point	2 Points	3 Points	
			3 : 0				
Penatlity					Penatlity		
C1: HC, C2:				3:0	C1: C1, C2:		
WINNER				Total			

PTS

Decision of Superiority

Judge 1	Judge 2	Judge 3	Judge 4	Judge 5	Judge 6	Judge 7	Referee

Name _____

Signature _____

Lion Cup 2024 Luxembourg

297 Rue de Reckenthal L-2410 Strassen, LUXEMBOURG

Court Nr.	2	Pool	2	Date	2024-06-08	Field Position	2
RED				BLUE			
NOC	BOSCOLO NATHAN (BEL)			NOC	TARCHI SEDKI (BEL)		
Category	Kumite Male U14 -40kg						
3 Points	2 Points	1 Point	Score	1 Point	2 Points	3 Points	
			10 : 0				
Penatlity					Penatlity		
C1: C1, C2:				10:0	C1: C1, C2:		
WINNER				Total			

PTS

Decision of Superiority

Judge 1	Judge 2	Judge 3	Judge 4	Judge 5	Judge 6	Judge 7	Referee

Name _____

Signature _____

Lion Cup 2024 Luxembourg - 2024-06-07

Official Results

Kumite Male U14 -40kg			
1	DERNONCOURT SOFIANE		BEL - BELGIUM
2	VUONG LEVIN		SUI - SWITZERLAND
3	AZIBOUS YANIS		BEL - BELGIUM
3	BOSCOLO NATHAN		BEL - BELGIUM
5	GUETARI OUSSAMA		BEL - BELGIUM
5	ZAKHNINI IMRANE		BEL - BELGIUM
7	RONDHUIS DEX		NED - NETHERLANDS
7	TARCHI SEDKI		BEL - BELGIUM

KUMITE MALE U14 -50KG

Lion Cup 2024 Luxembourg

ENTRIES BY WEIGHT CATEGORY
Kumite Male U14 -50kg

As of 8 JUN 2024

NOC Code	Gender	Name	Seeding
BEL	M	Albu David	
BEL	M	El-aidi Omar	
FRA	M	Souidi elias	
GER	M	Morina Artion	
GER	M	Ruhmann Benjamin	
LUX	M	Rimilinger Jean	
LUX	M	Spagnuolo Liam	
NED	M	Kaewborisut Aaron	
NED	M	Lebens Jax	
NED	M	Leijen Finn	
NED	M	Stoutjesdijk Aaron	
SUI	M	Alfonso Perez Eloy	
SUI	M	Gloor Leon	
SUI	M	Krähenbühl Lian	
SUI	M	Limacher Ramon	
SUI	M	Musa Lorian	
SUI	M	Tiefenauer Jonathan	

Kumite Male U14 -50kg

Lion Cup 2024 Luxembourg, 297 Rue de Reckenthal L-2410 Strassen, LUX

2024-06-08

Tatami

2 13:10

Pool

1/1

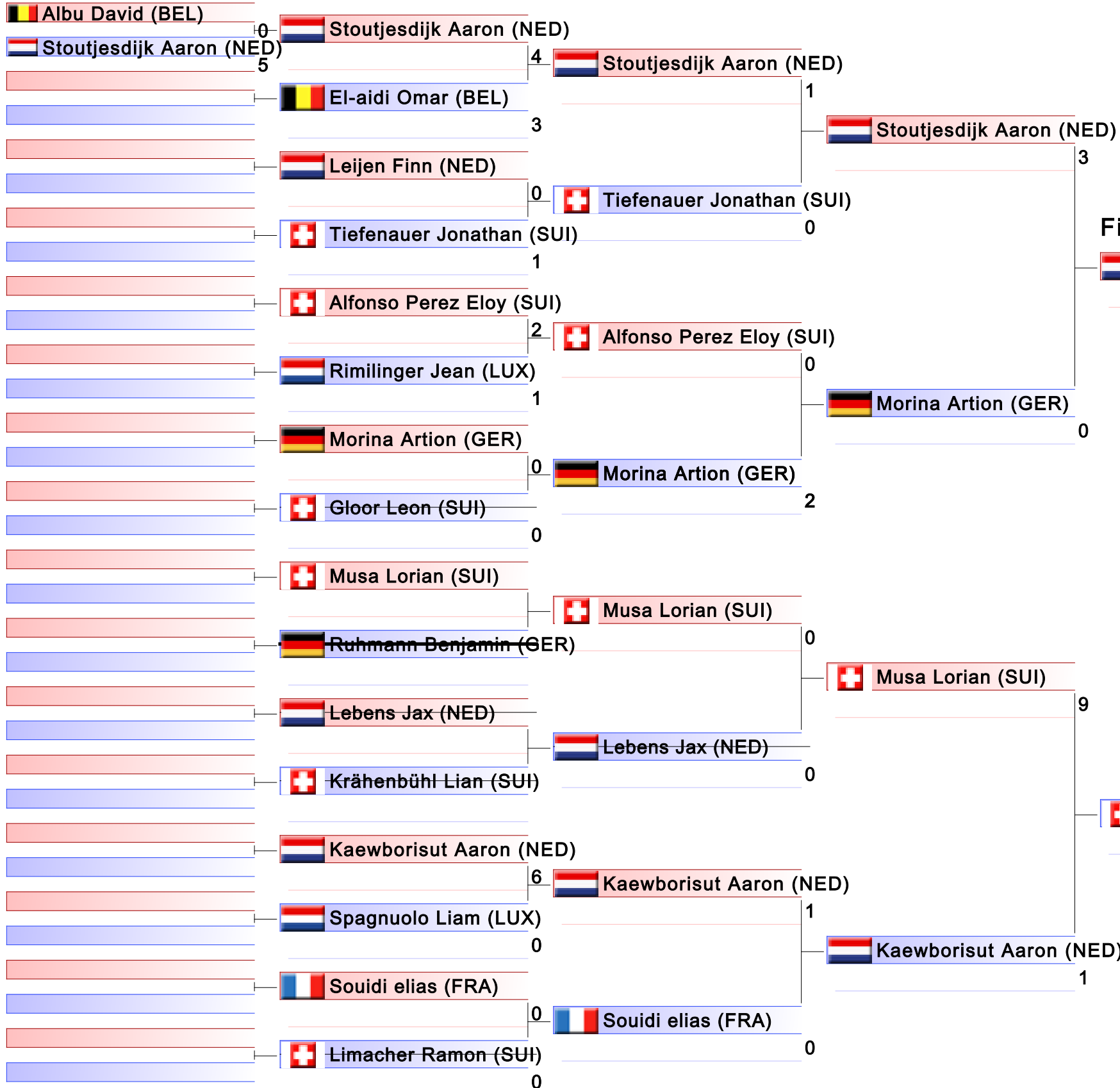

1. MUSA LORIAN (SUI)
2. STOUTJESDIJK AARON (NED)
3. KAEWBORISUT AARON (NED)
3. EL-AIDI OMAR (BEL)
5. MORINA ARTION (GER)
7. TIEFENAUER JONATHAN (SUI)

Kumite Male U14 -50kg

Lion Cup 2024 Luxembourg

2024-06-08

Tatami
2 14:00

Pool
1

(c)sportdata GmbH & Co KG 2000-2024 (2024-06-08 18:41) v 10.1.0 build 1 (2024-01-24 23:23 CET) License: Online_Event_ID-7672_LionCup2024Luxembourg (expire 2024-06-21)

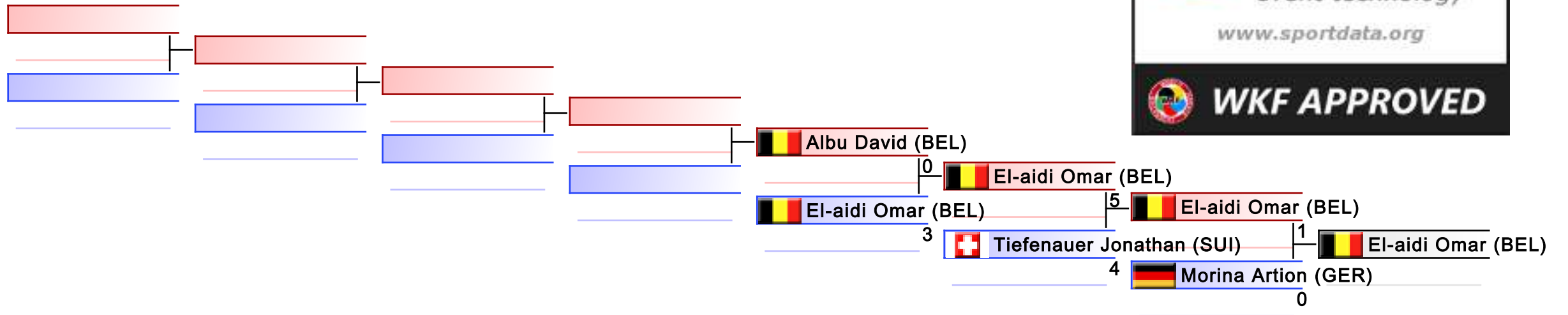

REPECHAGE: (1)

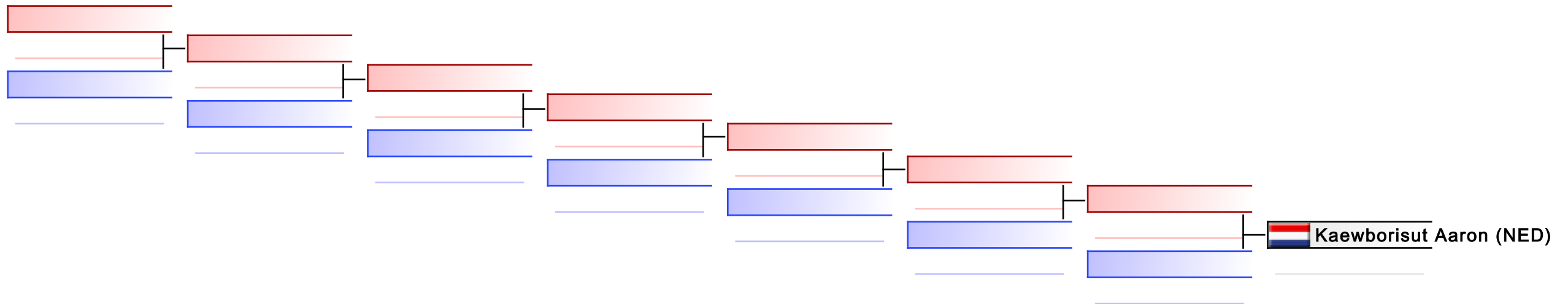

Lion Cup 2024 Luxembourg

297 Rue de Reckenthal L-2410 Strassen, LUXEMBOURG

Court Nr.	1	Pool	1	Date	2024-06-08	Field Position	33	
RED				BLUE				
NOC	ALBU DAVID (BEL)			NOC	STOUTJESDIJK AARON (NED)			
Category	Kumite Male U14 -50kg							
3 Points	2 Points	1 Point	Score	1 Point	2 Points	3 Points		
			0 : 5					
Penatlity				Penatlity				
C1: C1, C2:				0:5	C1: HC, C2:			
				Total	WINNER			

Decision of Superiority

Judge 1	Judge 2	Judge 3	Judge 4	Judge 5	Judge 6	Judge 7	Referee

Name _____

Signature _____

Lion Cup 2024 Luxembourg

297 Rue de Reckenthal L-2410 Strassen, LUXEMBOURG

Court Nr.	1	Pool	1	Date	2024-06-08	Field Position	49
RED				BLUE			
NOC	STOUTJESDIJK AARON (NED)			NOC	EL-AIDI OMAR (BEL)		
Category	Kumite Male U14 -50kg						
3 Points	2 Points	1 Point	Score	1 Point	2 Points	3 Points	
			4 : 3				
Penatlity					Penatlity		
C1: C2, C2:				4:3	C1: HC, C2:		
WINNER				Total			

Decision of Superiority

Judge 1	Judge 2	Judge 3	Judge 4	Judge 5	Judge 6	Judge 7	Referee

Name _____

Signature _____

Lion Cup 2024 Luxembourg

297 Rue de Reckenthal L-2410 Strassen, LUXEMBOURG

Court Nr.	1	Pool	1	Date	2024-06-08	Field Position	50	
RED				BLUE				
NOC	LEIJEN FINN (NED)			NOC	TIEFENAUER JONATHAN (SUI)			
Category	Kumite Male U14 -50kg							
3 Points	2 Points	1 Point	Score	1 Point	2 Points	3 Points		
			0 : 1					
Penatlity				Penatlity				
C1: C2, C2:				0:1	C1: C3, C2:			
				Total	WINNER			

Decision of Superiority

Judge 1	Judge 2	Judge 3	Judge 4	Judge 5	Judge 6	Judge 7	Referee

Name _____

Signature _____

Lion Cup 2024 Luxembourg

297 Rue de Reckenthal L-2410 Strassen, LUXEMBOURG

Court Nr.	1	Pool	1	Date	2024-06-08	Field Position	51
RED				BLUE			
NOC	ALFONSO PEREZ ELOY (SUI)			NOC	RIMILINGER JEAN (LUX)		
Category	Kumite Male U14 -50kg						
3 Points	2 Points	1 Point	Score	1 Point	2 Points	3 Points	
			2 : 1				
Penatlity				Penatlity			
C1: C1, C2:			2:1	C1: C1, C2:			
WINNER			Total				

Decision of Superiority

Judge 1	Judge 2	Judge 3	Judge 4	Judge 5	Judge 6	Judge 7	Referee

Name _____

Signature _____

Lion Cup 2024 Luxembourg

297 Rue de Reckenthal L-2410 Strassen, LUXEMBOURG

Court Nr.	1	Pool	1	Date	2024-06-08	Field Position	55
RED				BLUE			
NOC	KAEWBORISUT AARON (NED)			NOC	SPAGNUOLO LIAM (LUX)		
Category	Kumite Male U14 -50kg						
3 Points	2 Points	1 Point	Score	1 Point	2 Points	3 Points	
			6 : 0				
Penatlity				Penatlity			
C1: , C2:			6:0	C1: , C2:			
WINNER			Total				

Decision of Superiority

Judge 1	Judge 2	Judge 3	Judge 4	Judge 5	Judge 6	Judge 7	Referee

Name _____

Signature _____

Lion Cup 2024 Luxembourg

297 Rue de Reckenthal L-2410 Strassen, LUXEMBOURG

Court Nr.	1	Pool	1	Date	2024-06-08	Field Position	57	
RED				BLUE				
NOC	STOUTJESDIJK AARON (NED)			NOC	TIEFENAUER JONATHAN (SUI)			
Category	Kumite Male U14 -50kg							
3 Points	2 Points	1 Point	Score	1 Point	2 Points	3 Points		
			1 : 0					
Penatlity				Penatlity				
C1: HC, C2:				1:0	C1: C3, C2:			
WINNER				Total				

Decision of Superiority

Judge 1	Judge 2	Judge 3	Judge 4	Judge 5	Judge 6	Judge 7	Referee

Name _____

Signature _____

Lion Cup 2024 Luxembourg

297 Rue de Reckenthal L-2410 Strassen, LUXEMBOURG

Court Nr.	1	Pool	1	Date	2024-06-08	Field Position	58
RED				BLUE			
NOC	ALFONSO PEREZ ELOY (SUI)			NOC	MORINA ARTION (GER)		
Category	Kumite Male U14 -50kg						
3 Points	2 Points	1 Point	Score	1 Point	2 Points	3 Points	
			0 : 2				
Penatlity				Penatlity			
C1: C1, C2:			0:2	C1: C1, C2:			
			Total	WINNER			

Decision of Superiority

Judge 1	Judge 2	Judge 3	Judge 4	Judge 5	Judge 6	Judge 7	Referee

Name _____

Signature _____

Lion Cup 2024 Luxembourg

297 Rue de Reckenthal L-2410 Strassen, LUXEMBOURG

Court Nr.	1	Pool	1	Date	2024-06-08	Field Position	60
RED				BLUE			
NOC	KAEWBORISUT AARON (NED)			NOC	SOUIDI ELIAS (FRA)		
Category	Kumite Male U14 -50kg						
3 Points	2 Points	1 Point	Score	1 Point	2 Points	3 Points	
			1 : 0				
Penatlity				Penatlity			
C1: C2, C2:			1:0	C1: C3, C2:			
WINNER			Total				

Decision of Superiority

Judge 1	Judge 2	Judge 3	Judge 4	Judge 5	Judge 6	Judge 7	Referee

Name _____

Signature _____

Lion Cup 2024 Luxembourg

297 Rue de Reckenthal L-2410 Strassen, LUXEMBOURG

Court Nr.	1	Pool	1	Date	2024-06-08	Field Position	61
RED				BLUE			
NOC	STOUTJESDIJK AARON (NED)			NOC	MORINA ARTION (GER)		
Category	Kumite Male U14 -50kg						
3 Points	2 Points	1 Point	Score	1 Point	2 Points	3 Points	
			3 : 0				
Penatlity				Penatlity			
C1: C3, C2:				3:0	C1: , C2:		
WINNER				Total			

Decision of Superiority

Judge 1	Judge 2	Judge 3	Judge 4	Judge 5	Judge 6	Judge 7	Referee

Name _____

Signature _____

Lion Cup 2024 Luxembourg

297 Rue de Reckenthal L-2410 Strassen, LUXEMBOURG

Court Nr.	1	Pool	1	Date	2024-06-08	Field Position	62	
RED				BLUE				
NOC	MUSA LORIAN (SUI)			NOC	KAEWBORISUT AARON (NED)			
Category	Kumite Male U14 -50kg							
3 Points	2 Points	1 Point	Score	1 Point	2 Points	3 Points		
			9 : 1					
Penatlity				Penatlity				
C1: , C2:				9:1	C1: C1, C2:			
WINNER				Total				

Decision of Superiority

Judge 1	Judge 2	Judge 3	Judge 4	Judge 5	Judge 6	Judge 7	Referee

Name _____

Signature _____

Lion Cup 2024 Luxembourg

297 Rue de Reckenthal L-2410 Strassen, LUXEMBOURG

Court Nr.	1	Pool	1	Date	2024-06-08	Field Position	63
RED				BLUE			
NOC	STOUTJESDIJK AARON (NED)			NOC	MUSA LORIAN (SUI)		
Category	Kumite Male U14 -50kg						
3 Points	2 Points	1 Point	Score	1 Point	2 Points	3 Points	
			1 : 2				
Penatlity					Penatlity		
C1: C2, C2:				1:2	C1: HC, C2:		
				Total	WINNER		

Decision of Superiority

Judge 1	Judge 2	Judge 3	Judge 4	Judge 5	Judge 6	Judge 7	Referee

Name _____

Signature _____

Lion Cup 2024 Luxembourg

297 Rue de Reckenthal L-2410 Strassen, LUXEMBOURG

Court Nr.	1	Pool	1	Date	2024-06-08	Field Position	0
RED				BLUE			
NOC	EL-AIDI OMAR (BEL)			NOC	MORINA ARTION (GER)		
Category	Kumite Male U14 -50kg						
3 Points	2 Points	1 Point	Score	1 Point	2 Points	3 Points	
			1 : 0				
Penatlity					Penatlity		
C1: HC, C2:				1:0	C1: C1, C2:		
WINNER				Total			

Decision of Superiority

Judge 1	Judge 2	Judge 3	Judge 4	Judge 5	Judge 6	Judge 7	Referee

Name _____

Signature _____

Lion Cup 2024 Luxembourg

297 Rue de Reckenthal L-2410 Strassen, LUXEMBOURG

Court Nr.	1	Pool	1	Date	2024-06-08	Field Position	2
RED				BLUE			
NOC	EL-AIDI OMAR (BEL)			NOC	TIEFENAUER JONATHAN (SUI)		
Category	Kumite Male U14 -50kg						
3 Points	2 Points	1 Point	Score	1 Point	2 Points	3 Points	
			5 : 4				
Penatlity					Penatlity		
C1: HC, C2:				5:4	C1: , C2:		
WINNER				Total			

Decision of Superiority

Judge 1	Judge 2	Judge 3	Judge 4	Judge 5	Judge 6	Judge 7	Referee

Name _____

Signature _____

Lion Cup 2024 Luxembourg

297 Rue de Reckenthal L-2410 Strassen, LUXEMBOURG

Court Nr.	1	Pool	1	Date	2024-06-08	Field Position	4
RED				BLUE			
NOC	ALBU DAVID (BEL)			NOC	EL-AIDI OMAR (BEL)		
Category	Kumite Male U14 -50kg						
3 Points	2 Points	1 Point	Score	1 Point	2 Points	3 Points	
			:				
Penatlity				Penatlity			
			Total				

Decision of Superiority

Judge 1	Judge 2	Judge 3	Judge 4	Judge 5	Judge 6	Judge 7	Referee

Name _____

Signature _____

Official Results

Kumite Male U14 -50kg			
1	MUSA LORIAN		SUI - SWITZERLAND
2	STOUTJESDIJK AARON		NED - NETHERLANDS
3	KAEWBORISUT AARON		NED - NETHERLANDS
3	EL-AIDI OMAR		BEL - BELGIUM
5	MORINA ARTION		GER - GERMANY
7	TIEFENAUER JONATHAN		SUI - SWITZERLAND
9	ALBU DAVID		BEL - BELGIUM

KUMITE MALE U16 +70KG

Lion Cup 2024 Luxembourg

ENTRIES BY WEIGHT CATEGORY
Kumite Male U16 +70kg

As of 8 JUN 2024

NOC Code	Gender	Name	Seeding
ALG	M	MARCHOUD MOHAMED HICHEM	
BEL	M	amine azahaf mohamed	
BEL	M	lazaridis panagiotis	
BEL	M	TSHIBASSU Christopher	
BEL	M	Vanderheyden Roel	
NED	M	de Rover Luke	
NED	M	El Jattari Mohammed Amine	
NED	M	Meurs Robin	
NED	M	Twisk Patrick	
NED	M	Zarchid Moncef	

Kumite Male U16 +70kg

Lion Cup 2024 Luxembourg, 297 Rue de Reckenthal L-2410 Strassen, LUX

2024-06-08

Tatami
3 16:55

Pool
1 / 1

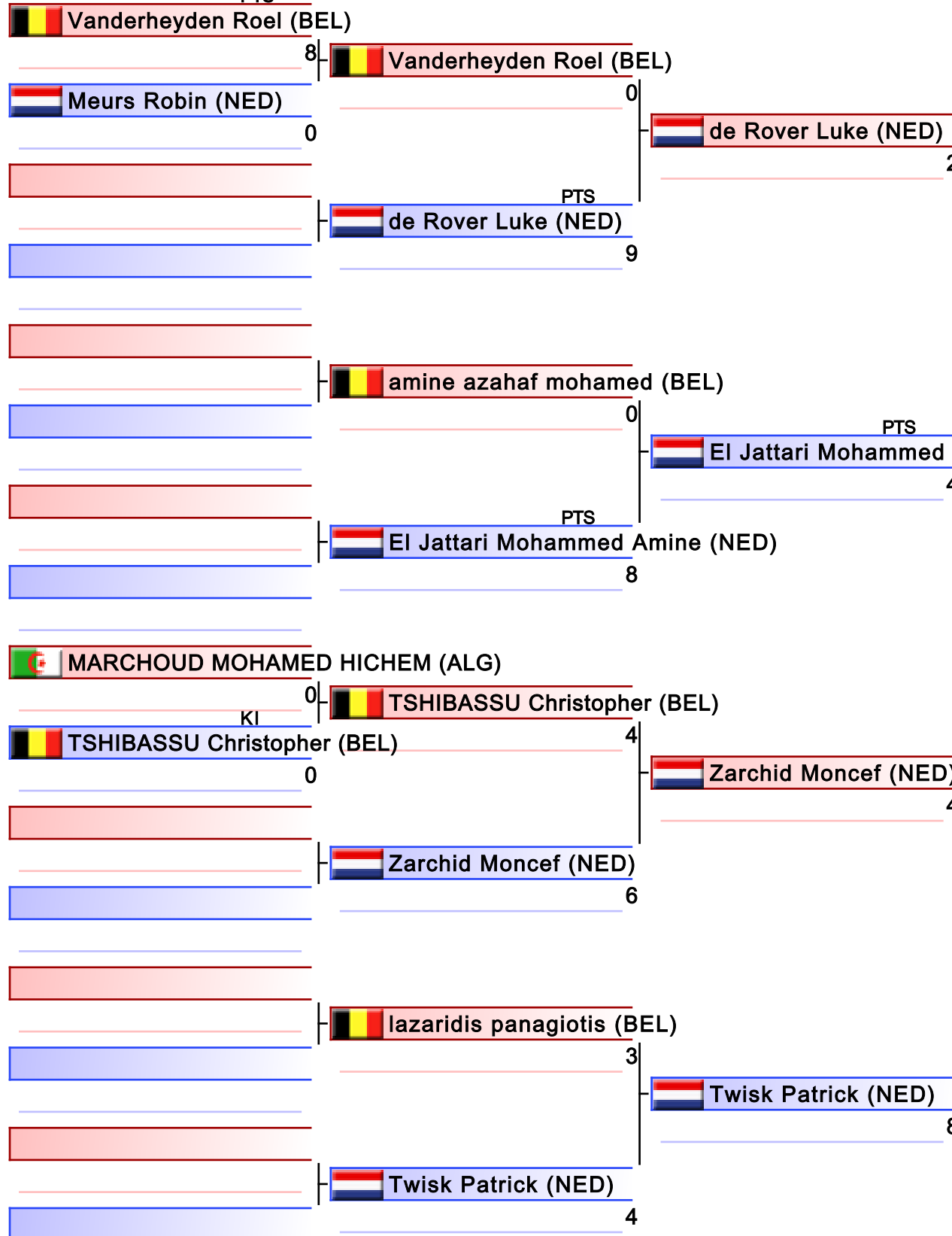

El Jattari Mohammed Amine (NED)

1. EL JATTARI MOHAMMED AMINE (NED)
2. TWISK PATRICK (NED)
3. DE ROVER LUKE (NED)
3. ZARCHID MONCEF (NED)
5. AMINE AZAHAF MOHAMED (BEL)
5. LAZARIDIS PANAGIOTIS (BEL)

Kumite Male U16 +70kg

Lion Cup 2024 Luxembourg

2024-06-08

Tatami
3 17:25

Pool
1

(c)sportdata GmbH & Co KG 2000-2024 (2024-06-08 18:41) v 10.1.0 build 1 (2024-01-24 23:23 CET) License: Online_Event_ID-7672_LionCup2024Luxembourg (expire 2024-06-21)

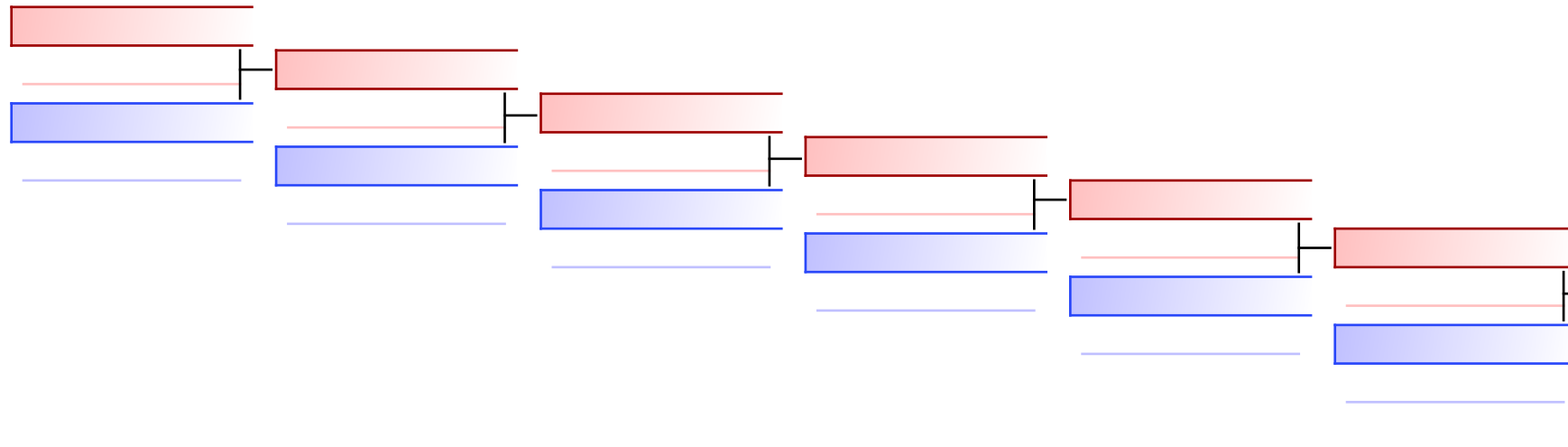

amine azahaf mohamed (BEL) 0
PTS de Rover Luke (NED)
 de Rover Luke (NED) 8

REPECHAGE: (1)

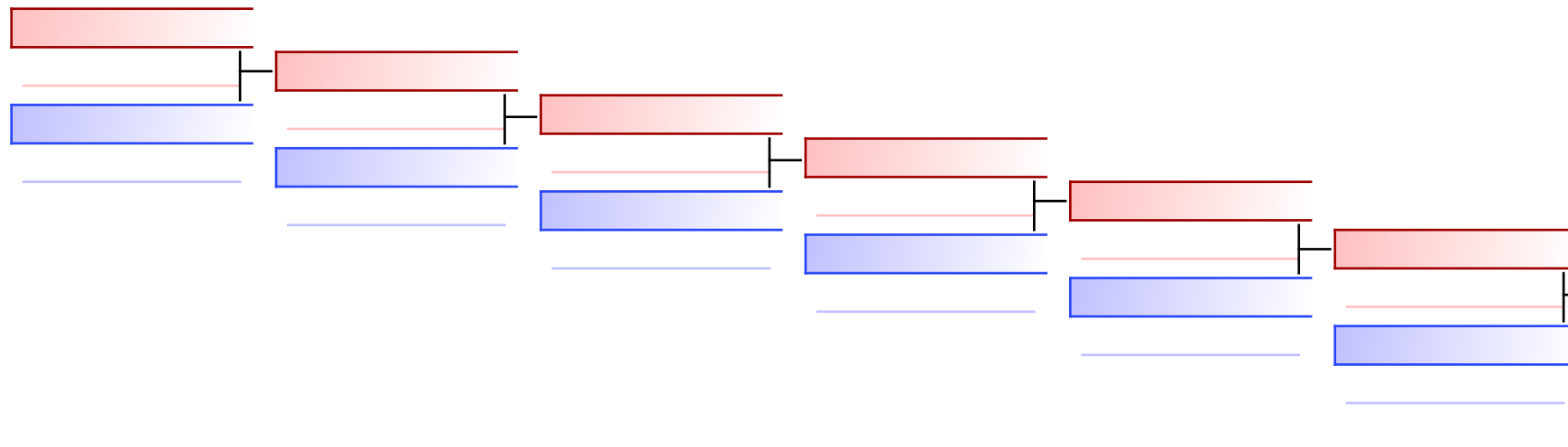

lazaridis panagiotis (BEL) 4
 Zarchid Moncef (NED)
 Zarchid Moncef (NED) 5

Lion Cup 2024 Luxembourg

297 Rue de Reckenthal L-2410 Strassen, LUXEMBOURG

Court Nr.	1	Pool	1	Date	2024-06-08	Field Position	49
RED				BLUE			
NOC	VANDERHEYDEN ROEL (BEL)			NOC	MEURS ROBIN (NED)		
Category	Kumite Male U16 +70kg						
3 Points	2 Points	1 Point	Score	1 Point	2 Points	3 Points	
			8 : 0				
Penatlity				Penatlity			
C1: C2, C2:				8:0	C1: , C2:		
WINNER				Total			

PTS

Decision of Superiority

Judge 1	Judge 2	Judge 3	Judge 4	Judge 5	Judge 6	Judge 7	Referee

Name _____

Signature _____

Lion Cup 2024 Luxembourg

297 Rue de Reckenthal L-2410 Strassen, LUXEMBOURG

Court Nr.	1	Pool	1	Date	2024-06-08	Field Position	53
RED				BLUE			
NOC	MARCHOUD MOHAMED HICHEM (ALG)			NOC	TSHIBASSU CHRISTOPHER (BEL)		
Category	Kumite Male U16 +70kg						
3 Points	2 Points	1 Point	Score	1 Point	2 Points	3 Points	
			0 : 0				
Penatlity				Penatlity			
C1: , C2:				0:0	C1: , C2:		
				Total	WINNER		

KI

Decision of Superiority

Judge 1	Judge 2	Judge 3	Judge 4	Judge 5	Judge 6	Judge 7	Referee

Name _____

Signature _____

Lion Cup 2024 Luxembourg

297 Rue de Reckenthal L-2410 Strassen, LUXEMBOURG

Court Nr.	1	Pool	1	Date	2024-06-08	Field Position	57	
RED				BLUE				
NOC	VANDERHEYDEN ROEL (BEL)			NOC	DE ROVER LUKE (NED)			
Category	Kumite Male U16 +70kg							
3 Points	2 Points	1 Point	Score	1 Point	2 Points	3 Points		
			0 : 9					
Penatlity				Penatlity				
C1: , C2:				0:9	C1: C1, C2:			
				Total	WINNER			

PTS

Decision of Superiority

Judge 1	Judge 2	Judge 3	Judge 4	Judge 5	Judge 6	Judge 7	Referee

Name _____

Signature _____

Lion Cup 2024 Luxembourg

297 Rue de Reckenthal L-2410 Strassen, LUXEMBOURG

Court Nr.	1	Pool	1	Date	2024-06-08	Field Position	58
RED				BLUE			
NOC	AMINE AZAHAF MOHAMED (BEL)			NOC	EL JATTARI MOHAMMED AMINE (NED)		
Category	Kumite Male U16 +70kg						
3 Points	2 Points	1 Point	Score	1 Point	2 Points	3 Points	
			0 : 8				
Penatlity				Penatlity			
C1: C1, C2:				0:8	C1: , C2:		
				Total	WINNER		

PTS

Decision of Superiority

Judge 1	Judge 2	Judge 3	Judge 4	Judge 5	Judge 6	Judge 7	Referee

Name _____

Signature _____

Lion Cup 2024 Luxembourg

297 Rue de Reckenthal L-2410 Strassen, LUXEMBOURG

Court Nr.	1	Pool	1	Date	2024-06-08	Field Position	59	
RED				BLUE				
NOC	TSHIBASSU CHRISTOPHER (BEL)			NOC	ZARCHID MONCEF (NED)			
Category	Kumite Male U16 +70kg							
3 Points	2 Points	1 Point	Score	1 Point	2 Points	3 Points		
			4 : 6					
Penatlity				Penatlity				
C1: C2, C2:				4:6	C1: HC, C2:			
				Total	WINNER			

Decision of Superiority

Judge 1	Judge 2	Judge 3	Judge 4	Judge 5	Judge 6	Judge 7	Referee

Name _____

Signature _____

Lion Cup 2024 Luxembourg

297 Rue de Reckenthal L-2410 Strassen, LUXEMBOURG

Court Nr.	1	Pool	1	Date	2024-06-08	Field Position	60
RED				BLUE			
NOC	LAZARIDIS PANAGIOTIS (BEL)			NOC	TWISK PATRICK (NED)		
Category	Kumite Male U16 +70kg						
3 Points	2 Points	1 Point	Score	1 Point	2 Points	3 Points	
			3 : 4				
Penatlity				Penatlity			
C1: C1, C2:				3:4	C1: C2, C2:		
				Total	WINNER		

Decision of Superiority

Judge 1	Judge 2	Judge 3	Judge 4	Judge 5	Judge 6	Judge 7	Referee

Name _____

Signature _____

Lion Cup 2024 Luxembourg

297 Rue de Reckenthal L-2410 Strassen, LUXEMBOURG

Court Nr.	1	Pool	1	Date	2024-06-08	Field Position	61
RED				BLUE			
NOC	DE ROVER LUKE (NED)			NOC	EL JATTARI MOHAMMED AMINE (NED)		
Category	Kumite Male U16 +70kg						
3 Points	2 Points	1 Point	Score	1 Point	2 Points	3 Points	
			2 : 4				
Penatlity					Penatlity		
C1: C3, C2:				2:4	C1: , C2:		
				Total	WINNER		

PTS

Decision of Superiority

Judge 1	Judge 2	Judge 3	Judge 4	Judge 5	Judge 6	Judge 7	Referee

Name _____

Signature _____

Lion Cup 2024 Luxembourg

297 Rue de Reckenthal L-2410 Strassen, LUXEMBOURG

Court Nr.	1	Pool	1	Date	2024-06-08	Field Position	62	
RED				BLUE				
NOC	ZARCHID MONCEF (NED)			NOC	TWISK PATRICK (NED)			
Category	Kumite Male U16 +70kg							
3 Points	2 Points	1 Point	Score	1 Point	2 Points	3 Points		
			4 : 8					
Penatlity				Penatlity				
C1: H, C2:				4:8	C1: C2, C2:			
				Total	WINNER			

Decision of Superiority

Judge 1	Judge 2	Judge 3	Judge 4	Judge 5	Judge 6	Judge 7	Referee

Name _____

Signature _____

Lion Cup 2024 Luxembourg

297 Rue de Reckenthal L-2410 Strassen, LUXEMBOURG

Court Nr.	1	Pool	1	Date	2024-06-08	Field Position	63	
RED				BLUE				
NOC	EL JATTARI MOHAMMED AMINE (NED)			NOC	TWISK PATRICK (NED)			
Category	Kumite Male U16 +70kg							
3 Points	2 Points	1 Point	Score	1 Point	2 Points	3 Points		
			6 : 4					
Penatlity				Penatlity				
C1: C1, C2:				6:4	C1: HC, C2:			
WINNER				Total				

Decision of Superiority

Judge 1	Judge 2	Judge 3	Judge 4	Judge 5	Judge 6	Judge 7	Referee

Name _____

Signature _____

Lion Cup 2024 Luxembourg

297 Rue de Reckenthal L-2410 Strassen, LUXEMBOURG

Court Nr.	1	Pool	1	Date	2024-06-08	Field Position	0
RED				BLUE			
NOC	AMINE AZAHAF MOHAMED (BEL)			NOC	DE ROVER LUKE (NED)		
Category	Kumite Male U16 +70kg						
3 Points	2 Points	1 Point	Score	1 Point	2 Points	3 Points	
			0 : 8				
Penatlity				Penatlity			
C1: , C2:				0:8	C1: , C2:		
				Total	WINNER		

PTS

Decision of Superiority

Judge 1	Judge 2	Judge 3	Judge 4	Judge 5	Judge 6	Judge 7	Referee

Name _____

Signature _____

Lion Cup 2024 Luxembourg

297 Rue de Reckenthal L-2410 Strassen, LUXEMBOURG

Court Nr.	2	Pool	2	Date	2024-06-08	Field Position	0	
RED				BLUE				
NOC	LAZARIDIS PANAGIOTIS (BEL)			NOC	ZARCHID MONCEF (NED)			
Category	Kumite Male U16 +70kg							
3 Points	2 Points	1 Point	Score	1 Point	2 Points	3 Points		
			4 : 5					
Penatlity				Penatlity				
C1: C2, C2:				4:5	C1: C2, C2:			
				Total	WINNER			

Decision of Superiority

Judge 1	Judge 2	Judge 3	Judge 4	Judge 5	Judge 6	Judge 7	Referee

Name _____

Signature _____

Official Results

Kumite Male U16 +70kg			
1	EL JATTARI MOHAMMED AMINE		NED - NETHERLANDS
2	TWISK PATRICK		NED - NETHERLANDS
3	DE ROVER LUKE		NED - NETHERLANDS
3	ZARCHID MONCEF		NED - NETHERLANDS
5	AMINE AZAHAF MOHAMED		BEL - BELGIUM
5	LAZARIDIS PANAGIOTIS		BEL - BELGIUM

KUMITE MALE U16 -52KG

Lion Cup 2024 Luxembourg

ENTRIES BY WEIGHT CATEGORY
Kumite Male U16 -52kg

As of 8 JUN 2024

NOC Code	Gender	Name	Seeding
ALG	M	BEKHOUKHA MOHAMED	
ALG	M	MESSAHEL WAEL ABDELKADER	
AUT	M	Ackerbauer Sebastian Andreas	
BEL	M	Abdelmaki Youssef	
BEL	M	Bouzahzah Wail	
BEL	M	Gueteri Mohamed	
BEL	M	Hamoudane Hamza	
BEL	M	Laruelle Leo	
BEL	M	Roland Nathan	
BEL	M	Snellings Giel	
FRA	M	REBOURS Ilyes	
FRA	M	Shabayek Moaz	
LUX	M	Le Moigne Yvan	
LUX	M	SZEKERES Maxim	
LUX	M	Van Wissen Jan	
NED	M	Elghoul Yessin	
NED	M	Kharmich Adam	
NED	M	Lu Darrick	
SUI	M	Alves Da Gloria Patrick	
SUI	M	Del Medico Dominic	
SUI	M	Giaquinto Daniele	
SUI	M	Kanesan Sujash	
SUI	M	Lüthy Corsin Dion	
SUI	M	Mateus Gomes Cristiano	
SUI	M	Mateus Gomes Leonardo	
SUI	M	Patricio-Clémont Johan	
SUI	M	Zecca Lucas	

Kumite Male U16 -52kg

Lion Cup 2024 Luxembourg, 297 Rue de Reckenthal L-2410 Strassen, LUX

2024-06-08

Tatami
2 15:45

Pool
1 / 2

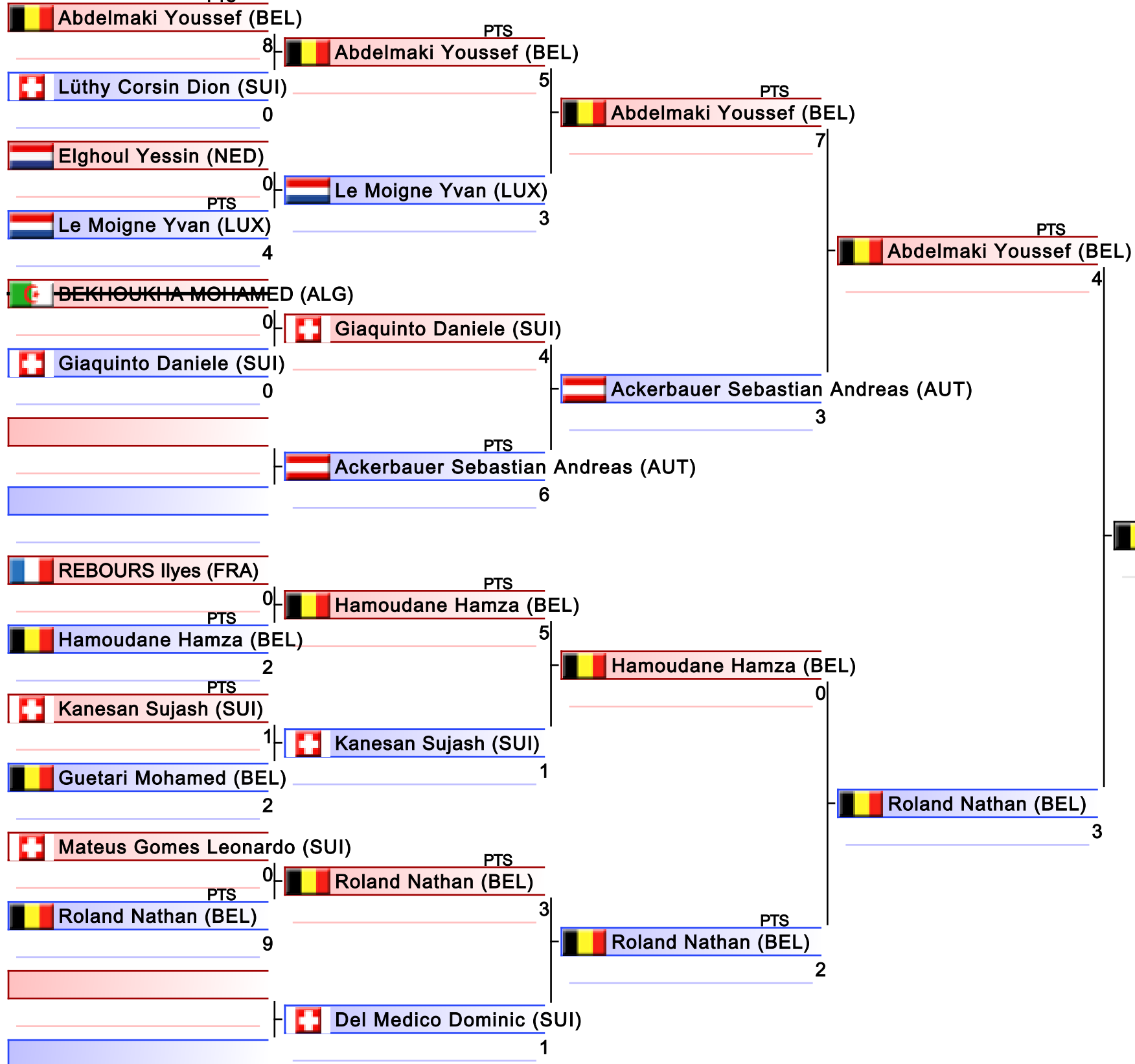

1. ZECCA LUCAS (SUI)
2. ABDELMAKI YOUSSEF (BEL)
3. ROLAND NATHAN (BEL)
3. SZEKERES MAXIM (LUX)
5. LE MOIGNE YVAN (LUX)
5. MATEUS GOMES CRISTIANO (SUI)
7. ACKERBAUER SEBASTIAN ANDREAS (AUT)
7. LU DARRICK (NED)

Kumite Male U16 -52kg

Lion Cup 2024 Luxembourg, 297 Rue de Reckenthal L-2410 Strassen, LUX

2024-06-08

Tatami
3 15:45

Pool
2/2

 MESSAHEL WAEEL ABDELKADER (ALG)

0 |  Zecca Lucas (SUI)

KI |  Zecca Lucas (SUI)

0 |

 Patricio-Clémont Johan (SUI)

0 |  Lu Darrick (NED)

 Lu Darrick (NED)

3 |

 Alves Da Gloria Patrick (SUI)

2 |  Laruelle Leo (BEL)

 Laruelle Leo (BEL)

0 |

 SZEKERES Maxim (LUX)

 SZEKERES Maxim (LUX)

2 |

 Shabayek Moaz (FRA)

8 |  Shabayek Moaz (FRA)

KI |  Van Wissen Jan (LUX)

0 |

 Bouzahzah Wail (BEL)

 Bouzahzah Wail (BEL)

0 |

 Mateus Gomes Cristiano (SUI)

1 |  Mateus Gomes Cristiano (SUI)

KI |  Snellings Giel (BEL)

0 |

 Mateus Gomes Cristiano (SUI)

 Kharmich Adam (NED)

0 |

 Zecca Lucas (SUI)

4 |

 Zecca Lucas (SUI)

5 |

 SZEKERES Maxim (LUX)

0 |

 Zecca Lucas (SUI)

 Mateus Gomes Cristiano (SUI)

2 |



1. ZECCA LUCAS (SUI)
2. ABDELMAKI YOUSSEF (BEL)
3. ROLAND NATHAN (BEL)
3. SZEKERES MAXIM (LUX)
5. LE MOIGNE YVAN (LUX)
5. MATEUS GOMES CRISTIANO (SUI)
7. ACKERBAUER SEBASTIAN ANDREAS (AUT)
7. LU DARRICK (NED)

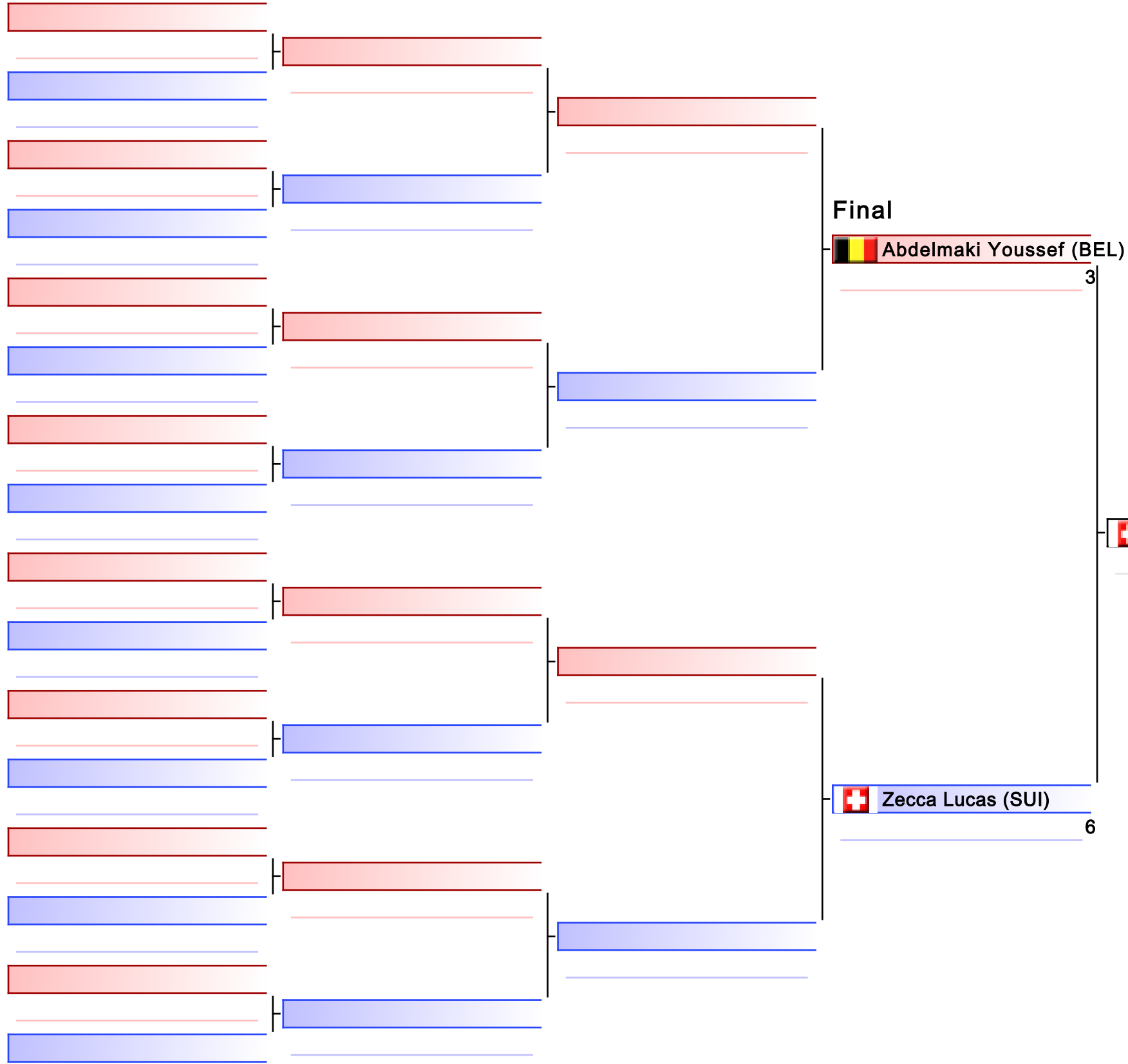

1. ZECCA LUCAS (SUI)
2. ABDELMAKI YOUSSEF (BEL)
3. ROLAND NATHAN (BEL)
3. SZEKERES MAXIM (LUX)
5. LE MOIGNE YVAN (LUX)
5. MATEUS GOMES CRISTIANO (SUI)
7. ACKERBAUER SEBASTIAN ANDREAS (AUT)
7. LU DARRICK (NED)

Kumite Male U16 -52kg

Lion Cup 2024 Luxembourg

2024-06-08

Tatami 3 16:35

Pool 2

(c)sportdata GmbH & Co KG 2000-2024 (2024-06-08 18:41) v 10.1.0 build 1 (2024-01-24 23:23 CET) License: Online_Event_ID-7672_LionCup2024Luxembourg (expire 2024-06-21)

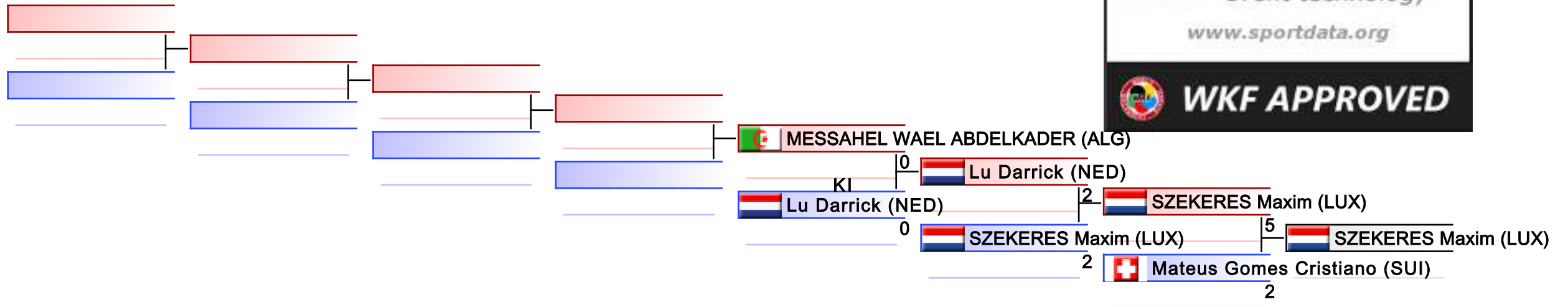

REPECHAGE: (2)

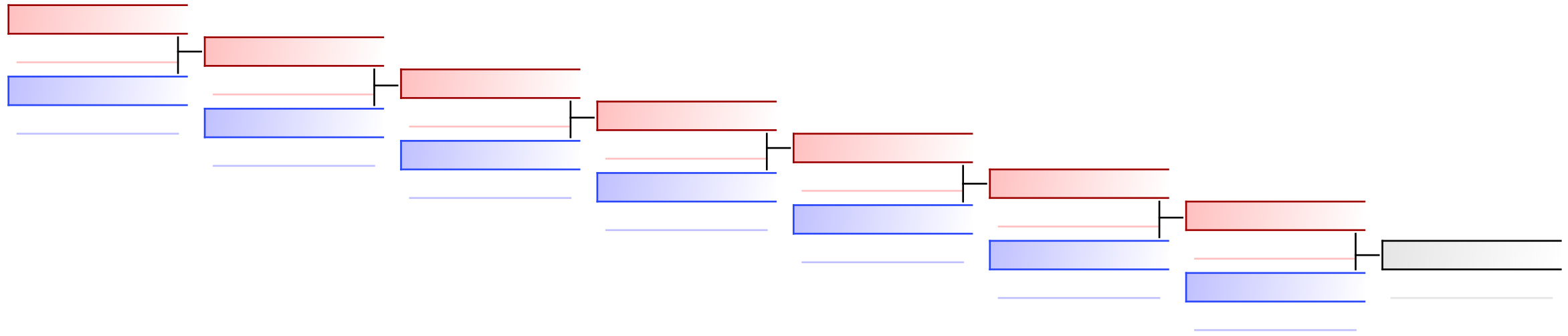

Lion Cup 2024 Luxembourg

297 Rue de Reckenthal L-2410 Strassen, LUXEMBOURG

Court Nr.	1	Pool	1	Date	2024-06-08	Field Position	49	
RED				BLUE				
NOC	ABDELMAKI YOUSSEF (BEL)			NOC	LTHY CORSIN DION (SUI)			
Category	Kumite Male U16 -52kg							
3 Points	2 Points	1 Point	Score	1 Point	2 Points	3 Points		
			8 : 0					
Penatlity				Penatlity				
C1: C3, C2:				8:0	C1: , C2:			
WINNER				Total				

PTS

Decision of Superiority

Judge 1	Judge 2	Judge 3	Judge 4	Judge 5	Judge 6	Judge 7	Referee

Name _____

Signature _____

Lion Cup 2024 Luxembourg

297 Rue de Reckenthal L-2410 Strassen, LUXEMBOURG

Court Nr.	1	Pool	1	Date	2024-06-08	Field Position	50	
RED				BLUE				
NOC	ELGHOUL YESSIN (NED)			NOC	LE MOIGNE YVAN (LUX)			
Category	Kumite Male U16 -52kg							
3 Points	2 Points	1 Point	Score	1 Point	2 Points	3 Points		
			0 : 4					
Penatlity				Penatlity				
C1: C3, C2:				0:4	C1: HC, C2:			
				Total	WINNER			

PTS

Decision of Superiority

Judge 1	Judge 2	Judge 3	Judge 4	Judge 5	Judge 6	Judge 7	Referee

Name _____

Signature _____

Lion Cup 2024 Luxembourg

297 Rue de Reckenthal L-2410 Strassen, LUXEMBOURG

Court Nr.	1	Pool	1	Date	2024-06-08	Field Position	53
RED				BLUE			
NOC	REBOURS ILYES (FRA)			NOC	HAMOUDANE HAMZA (BEL)		
Category	Kumite Male U16 -52kg						
3 Points	2 Points	1 Point	Score	1 Point	2 Points	3 Points	
			0 : 2				
Penatlity				Penatlity			
C1: C1, C2:				0:2	C1: , C2:		
				Total	WINNER		

PTS

Decision of Superiority

Judge 1	Judge 2	Judge 3	Judge 4	Judge 5	Judge 6	Judge 7	Referee

Name _____

Signature _____

Lion Cup 2024 Luxembourg

297 Rue de Reckenthal L-2410 Strassen, LUXEMBOURG

Court Nr.	1	Pool	1	Date	2024-06-08	Field Position	54	
RED				BLUE				
NOC	KANESAN SUJASH (SUI)			NOC	GUETARI MOHAMED (BEL)			
Category	Kumite Male U16 -52kg							
3 Points	2 Points	1 Point	Score	1 Point	2 Points	3 Points		
			1 : 2					
Penatlity				Penatlity				
C1: C3, C2:				1:2	C1: H, C2:			
WINNER				Total				

PTS

Decision of Superiority

Judge 1	Judge 2	Judge 3	Judge 4	Judge 5	Judge 6	Judge 7	Referee

Name _____

Signature _____

Lion Cup 2024 Luxembourg

297 Rue de Reckenthal L-2410 Strassen, LUXEMBOURG

Court Nr.	1	Pool	1	Date	2024-06-08	Field Position	55
RED				BLUE			
NOC	MATEUS GOMES LEONARDO (SUI)			NOC	ROLAND NATHAN (BEL)		
Category	Kumite Male U16 -52kg						
3 Points	2 Points	1 Point	Score	1 Point	2 Points	3 Points	
			0 : 9				
Penatlity				Penatlity			
C1: , C2:				0:9	C1: C2, C2:		
				Total	WINNER		

PTS

Decision of Superiority

Judge 1	Judge 2	Judge 3	Judge 4	Judge 5	Judge 6	Judge 7	Referee

Name _____

Signature _____

Lion Cup 2024 Luxembourg

297 Rue de Reckenthal L-2410 Strassen, LUXEMBOURG

Court Nr.	1	Pool	1	Date	2024-06-08	Field Position	57	
RED				BLUE				
NOC	ABDELMAKI YOUSSEF (BEL)			NOC	LE MOIGNE YVAN (LUX)			
Category	Kumite Male U16 -52kg							
3 Points	2 Points	1 Point	Score	1 Point	2 Points	3 Points		
			5 : 3					
Penatlity				Penatlity				
C1: HC, C2:				5:3	C1: HC, C2:			
WINNER				Total				

PTS

Decision of Superiority

Judge 1	Judge 2	Judge 3	Judge 4	Judge 5	Judge 6	Judge 7	Referee

Name _____

Signature _____

Lion Cup 2024 Luxembourg

297 Rue de Reckenthal L-2410 Strassen, LUXEMBOURG

Court Nr.	1	Pool	1	Date	2024-06-08	Field Position	58
RED				BLUE			
NOC	GIAQUINTO DANIELE (SUI)			NOC	ACKERBAUER SEBASTIAN ANDREAS (AUT)		
Category	Kumite Male U16 -52kg						
3 Points	2 Points	1 Point	Score	1 Point	2 Points	3 Points	
			4 : 6				
Penatlity				Penatlity			
C1: C1, C2:			4:6	C1: , C2:			
			Total	WINNER			

PTS

Decision of Superiority

Judge 1	Judge 2	Judge 3	Judge 4	Judge 5	Judge 6	Judge 7	Referee

Name _____

Signature _____

Lion Cup 2024 Luxembourg

297 Rue de Reckenthal L-2410 Strassen, LUXEMBOURG

Court Nr.	1	Pool	1	Date	2024-06-08	Field Position	59	
RED				BLUE				
NOC	HAMOUDANE HAMZA (BEL)			NOC	KANESAN SUJASH (SUI)			
Category	Kumite Male U16 -52kg							
3 Points	2 Points	1 Point	Score	1 Point	2 Points	3 Points		
			5 : 1					
Penatlity				Penatlity				
C1: C3, C2:				5:1	C1: HC, C2:			
WINNER				Total				

PTS

Decision of Superiority

Judge 1	Judge 2	Judge 3	Judge 4	Judge 5	Judge 6	Judge 7	Referee

Name _____

Signature _____

Lion Cup 2024 Luxembourg

297 Rue de Reckenthal L-2410 Strassen, LUXEMBOURG

Court Nr.	1	Pool	1	Date	2024-06-08	Field Position	60
RED				BLUE			
NOC	ROLAND NATHAN (BEL)			NOC	DEL MEDICO DOMINIC (SUI)		
Category	Kumite Male U16 -52kg						
3 Points	2 Points	1 Point	Score	1 Point	2 Points	3 Points	
			3 : 1				
Penatlity				Penatlity			
C1: , C2:				3:1	C1: , C2:		
WINNER				Total			

PTS

Decision of Superiority

Judge 1	Judge 2	Judge 3	Judge 4	Judge 5	Judge 6	Judge 7	Referee

Name _____

Signature _____

Lion Cup 2024 Luxembourg

297 Rue de Reckenthal L-2410 Strassen, LUXEMBOURG

Court Nr.	1	Pool	1	Date	2024-06-08	Field Position	61	
RED				BLUE				
NOC	ABDELMAKI YOUSSEF (BEL)			NOC	ACKERBAUER SEBASTIAN ANDREAS (AUT)			
Category	Kumite Male U16 -52kg							
3 Points	2 Points	1 Point	Score	1 Point	2 Points	3 Points		
			7 : 3					
Penatlity				Penatlity				
C1: C2, C2:				7:3	C1: C1, C2:			
WINNER				Total				

PTS

Decision of Superiority

Judge 1	Judge 2	Judge 3	Judge 4	Judge 5	Judge 6	Judge 7	Referee

Name _____

Signature _____

Lion Cup 2024 Luxembourg

297 Rue de Reckenthal L-2410 Strassen, LUXEMBOURG

Court Nr.	1	Pool	1	Date	2024-06-08	Field Position	62	
RED				BLUE				
NOC	HAMOUDANE HAMZA (BEL)			NOC	ROLAND NATHAN (BEL)			
Category	Kumite Male U16 -52kg							
3 Points	2 Points	1 Point	Score	1 Point	2 Points	3 Points		
			0 : 2					
Penatlity				Penatlity				
C1: C1, C2:				0:2	C1: HC, C2:			
				Total	WINNER			

PTS

Decision of Superiority

Judge 1	Judge 2	Judge 3	Judge 4	Judge 5	Judge 6	Judge 7	Referee

Name _____

Signature _____

Lion Cup 2024 Luxembourg

297 Rue de Reckenthal L-2410 Strassen, LUXEMBOURG

Court Nr.	1	Pool	1	Date	2024-06-08	Field Position	63
RED				BLUE			
NOC	ABDELMAKI YOUSSEF (BEL)			NOC	ROLAND NATHAN (BEL)		
Category	Kumite Male U16 -52kg						
3 Points	2 Points	1 Point	Score	1 Point	2 Points	3 Points	
			4 : 3				
Penatlity					Penatlity		
C1: HC, C2:				4:3	C1: , C2:		
WINNER				Total			

PTS

Decision of Superiority

Judge 1	Judge 2	Judge 3	Judge 4	Judge 5	Judge 6	Judge 7	Referee

Name _____

Signature _____

Lion Cup 2024 Luxembourg

297 Rue de Reckenthal L-2410 Strassen, LUXEMBOURG

Court Nr.	2	Pool	2	Date	2024-06-08	Field Position	49
RED				BLUE			
NOC	MESSAHEL WAEL ABDELKADER (ALG)			NOC	ZECCA LUCAS (SUI)		
Category	Kumite Male U16 -52kg						
3 Points	2 Points	1 Point	Score	1 Point	2 Points	3 Points	
			0 : 0				
Penatlity				Penatlity			
C1: , C2:				0:0	C1: , C2:		
				Total	WINNER		

KI

Decision of Superiority

Judge 1	Judge 2	Judge 3	Judge 4	Judge 5	Judge 6	Judge 7	Referee

Name _____

Signature _____

Lion Cup 2024 Luxembourg

297 Rue de Reckenthal L-2410 Strassen, LUXEMBOURG

Court Nr.	2	Pool	2	Date	2024-06-08	Field Position	50	
RED				BLUE				
NOC	PATRICIO-CLMONT JOHAN (SUI)			NOC	LU DARRICK (NED)			
Category	Kumite Male U16 -52kg							
3 Points	2 Points	1 Point	Score	1 Point	2 Points	3 Points		
			0 : 3					
Penatlity				Penatlity				
C1: C1, C2:				0:3	C1: HC, C2:			
				Total	WINNER			

Decision of Superiority

Judge 1	Judge 2	Judge 3	Judge 4	Judge 5	Judge 6	Judge 7	Referee

Name _____

Signature _____

Lion Cup 2024 Luxembourg

297 Rue de Reckenthal L-2410 Strassen, LUXEMBOURG

Court Nr.	2	Pool	2	Date	2024-06-08	Field Position	51	
RED				BLUE				
NOC	ALVES DA GLORIA PATRICK (SUI)			NOC	LARUELLE LEO (BEL)			
Category	Kumite Male U16 -52kg							
3 Points	2 Points	1 Point	Score	1 Point	2 Points	3 Points		
			2 : 0					
Penatlity				Penatlity				
C1: H, C2:				2:0	C1: HC, C2:			
				Total	WINNER			

Decision of Superiority

Judge 1	Judge 2	Judge 3	Judge 4	Judge 5	Judge 6	Judge 7	Referee

Name _____

Signature _____

Lion Cup 2024 Luxembourg

297 Rue de Reckenthal L-2410 Strassen, LUXEMBOURG

Court Nr.	2	Pool	2	Date	2024-06-08	Field Position	53	
RED				BLUE				
NOC	SHABAYEK MOAZ (FRA)			NOC	VAN WISSEN JAN (LUX)			
Category	Kumite Male U16 -52kg							
3 Points	2 Points	1 Point	Score	1 Point	2 Points	3 Points		
			8 : 0					
Penatlity				Penatlity				
C1: , C2:				8:0	C1: , C2:			
WINNER				Total				

Decision of Superiority

Judge 1	Judge 2	Judge 3	Judge 4	Judge 5	Judge 6	Judge 7	Referee

Name _____

Signature _____

Lion Cup 2024 Luxembourg

297 Rue de Reckenthal L-2410 Strassen, LUXEMBOURG

Court Nr.	2	Pool	2	Date	2024-06-08	Field Position	55	
RED				BLUE				
NOC	MATEUS GOMES CRISTIANO (SUI)			NOC	SNELLINGS GIEL (BEL)			
Category	Kumite Male U16 -52kg							
3 Points	2 Points	1 Point	Score	1 Point	2 Points	3 Points		
			1 : 0					
Penatlity				Penatlity				
C1: C1, C2:				1:0	C1: , C2:			
WINNER				Total				

Decision of Superiority

Judge 1	Judge 2	Judge 3	Judge 4	Judge 5	Judge 6	Judge 7	Referee

Name _____

Signature _____

Lion Cup 2024 Luxembourg

297 Rue de Reckenthal L-2410 Strassen, LUXEMBOURG

Court Nr.	2	Pool	2	Date	2024-06-08	Field Position	57
RED				BLUE			
NOC	ZECCA LUCAS (SUI)			NOC	LU DARRICK (NED)		
Category	Kumite Male U16 -52kg						
3 Points	2 Points	1 Point	Score	1 Point	2 Points	3 Points	
			6 : 4				
Penatlity				Penatlity			
C1: C3, C2:			6:4	C1: , C2:			
WINNER			Total				

Decision of Superiority

Judge 1	Judge 2	Judge 3	Judge 4	Judge 5	Judge 6	Judge 7	Referee

Name _____

Signature _____

Lion Cup 2024 Luxembourg

297 Rue de Reckenthal L-2410 Strassen, LUXEMBOURG

Court Nr.	2	Pool	2	Date	2024-06-08	Field Position	58
RED				BLUE			
NOC	LARUELLE LEO (BEL)			NOC	SZEKERES MAXIM (LUX)		
Category	Kumite Male U16 -52kg						
3 Points	2 Points	1 Point	Score	1 Point	2 Points	3 Points	
			2 : 2				
Penatlity				Penatlity			
C1: C1, C2:			2:2	C1: , C2:			
			Total	WINNER			

Decision of Superiority

Judge 1	Judge 2	Judge 3	Judge 4	Judge 5	Judge 6	Judge 7	Referee

Name _____

Signature _____

Lion Cup 2024 Luxembourg

297 Rue de Reckenthal L-2410 Strassen, LUXEMBOURG

Court Nr.	2	Pool	2	Date	2024-06-08	Field Position	59
RED				BLUE			
NOC	SHABAYEK MOAZ (FRA)			NOC	BOUZAHZAH WAIL (BEL)		
Category	Kumite Male U16 -52kg						
3 Points	2 Points	1 Point	Score	1 Point	2 Points	3 Points	
			0 : 0				
Penatlity				Penatlity			
C1: , C2:				0:0	C1: , C2:		
WINNER				Total			

KI

Decision of Superiority

Judge 1	Judge 2	Judge 3	Judge 4	Judge 5	Judge 6	Judge 7	Referee

Name _____

Signature _____

Lion Cup 2024 Luxembourg

297 Rue de Reckenthal L-2410 Strassen, LUXEMBOURG

Court Nr.	2	Pool	2	Date	2024-06-08	Field Position	60
RED				BLUE			
NOC	MATEUS GOMES CRISTIANO (SUI)			NOC	KHARMICH ADAM (NED)		
Category	Kumite Male U16 -52kg						
3 Points	2 Points	1 Point	Score	1 Point	2 Points	3 Points	
			0 : 0				
Penatlity				Penatlity			
C1: , C2:				0:0	C1: , C2:		
WINNER				Total			

KI

Decision of Superiority

Judge 1	Judge 2	Judge 3	Judge 4	Judge 5	Judge 6	Judge 7	Referee

Name _____

Signature _____

Lion Cup 2024 Luxembourg

297 Rue de Reckenthal L-2410 Strassen, LUXEMBOURG

Court Nr.	2	Pool	2	Date	2024-06-08	Field Position	61	
RED				BLUE				
NOC	ZECCA LUCAS (SUI)			NOC	SZEKERES MAXIM (LUX)			
Category	Kumite Male U16 -52kg							
3 Points	2 Points	1 Point	Score	1 Point	2 Points	3 Points		
			4 : 0					
Penatlity				Penatlity				
C1: C3, C2:				4:0	C1: , C2:			
WINNER				Total				

Decision of Superiority

Judge 1	Judge 2	Judge 3	Judge 4	Judge 5	Judge 6	Judge 7	Referee

Name _____

Signature _____

Lion Cup 2024 Luxembourg

297 Rue de Reckenthal L-2410 Strassen, LUXEMBOURG

Court Nr.	2	Pool	2	Date	2024-06-08	Field Position	62
RED				BLUE			
NOC	SHABAYEK MOAZ (FRA)			NOC	MATEUS GOMES CRISTIANO (SUI)		
Category	Kumite Male U16 -52kg						
3 Points	2 Points	1 Point	Score	1 Point	2 Points	3 Points	
			1 : 5				
Penatlity				Penatlity			
C1: , C2:				1:5	C1: , C2:		
				Total	WINNER		

Decision of Superiority

Judge 1	Judge 2	Judge 3	Judge 4	Judge 5	Judge 6	Judge 7	Referee

Name _____

Signature _____

Lion Cup 2024 Luxembourg

297 Rue de Reckenthal L-2410 Strassen, LUXEMBOURG

Court Nr.	2	Pool	2	Date	2024-06-08	Field Position	63
RED				BLUE			
NOC	ZECCA LUCAS (SUI)			NOC	MATEUS GOMES CRISTIANO (SUI)		
Category	Kumite Male U16 -52kg						
3 Points	2 Points	1 Point	Score	1 Point	2 Points	3 Points	
			5 : 2				
Penatlity				Penatlity			
C1: C1, C2:			5:2	C1: C1, C2:			
WINNER			Total				

Decision of Superiority

Judge 1	Judge 2	Judge 3	Judge 4	Judge 5	Judge 6	Judge 7	Referee

Name _____

Signature _____

Lion Cup 2024 Luxembourg

297 Rue de Reckenthal L-2410 Strassen, LUXEMBOURG

Court Nr.	1	Pool	1	Date	2024-06-08	Field Position	63	
RED				BLUE				
NOC	ABDELMAKI YOUSSEF (BEL)			NOC	ZECCA LUCAS (SUI)			
Category	Kumite Male U16 -52kg							
3 Points	2 Points	1 Point	Score	1 Point	2 Points	3 Points		
			3 : 6					
Penatlity				Penatlity				
C1: C3, C2:				3:6	C1: HC, C2:			
				Total	WINNER			

Decision of Superiority

Judge 1	Judge 2	Judge 3	Judge 4	Judge 5	Judge 6	Judge 7	Referee

Name _____

Signature _____

Lion Cup 2024 Luxembourg

297 Rue de Reckenthal L-2410 Strassen, LUXEMBOURG

Court Nr.	1	Pool	1	Date	2024-06-08	Field Position	0
RED				BLUE			
NOC	LE MOIGNE YVAN (LUX)			NOC	ROLAND NATHAN (BEL)		
Category	Kumite Male U16 -52kg						
3 Points	2 Points	1 Point	Score	1 Point	2 Points	3 Points	
			2 : 7				
Penatlity				Penatlity			
C1: H, C2:				2:7	C1: , C2:		
				Total	WINNER		

PTS

Decision of Superiority

Judge 1	Judge 2	Judge 3	Judge 4	Judge 5	Judge 6	Judge 7	Referee

Name _____

Signature _____

Lion Cup 2024 Luxembourg

297 Rue de Reckenthal L-2410 Strassen, LUXEMBOURG

Court Nr.	1	Pool	1	Date	2024-06-08	Field Position	2
RED				BLUE			
NOC	LE MOIGNE YVAN (LUX)			NOC	ACKERBAUER SEBASTIAN ANDREAS (AUT)		
Category	Kumite Male U16 -52kg						
3 Points	2 Points	1 Point	Score	1 Point	2 Points	3 Points	
			5 : 0				
Penatlity					Penatlity		
C1: C2, C2:				5:0	C1: C1, C2:		
WINNER				Total			

PTS

Decision of Superiority

Judge 1	Judge 2	Judge 3	Judge 4	Judge 5	Judge 6	Judge 7	Referee

Name _____

Signature _____

Lion Cup 2024 Luxembourg

297 Rue de Reckenthal L-2410 Strassen, LUXEMBOURG

Court Nr.	1	Pool	1	Date	2024-06-08	Field Position	4
RED				BLUE			
NOC	LTHY CORSIN DION (SUI)			NOC	LE MOIGNE YVAN (LUX)		
Category	Kumite Male U16 -52kg						
3 Points	2 Points	1 Point	Score	1 Point	2 Points	3 Points	
			:				
Penatlity				Penatlity			
			Total				

Decision of Superiority

Judge 1	Judge 2	Judge 3	Judge 4	Judge 5	Judge 6	Judge 7	Referee

Name _____

Signature _____

Lion Cup 2024 Luxembourg - 2024-06-07

Official Results

Kumite Male U16 -52kg			
1	ZECCA LUCAS		SUI - SWITZERLAND
2	ABDELMAKI YOUSSEF		BEL - BELGIUM
3	ROLAND NATHAN		BEL - BELGIUM
3	SZEKERES MAXIM		LUX - LUXEMBOURG
5	LE MOIGNE YVAN		LUX - LUXEMBOURG
5	MATEUS GOMES CRISTIANO		SUI - SWITZERLAND
7	ACKERBAUER SEBASTIAN ANDREAS		AUT - AUSTRIA
7	LU DARRICK		NED - NETHERLANDS
9	LÜTHY CORSIN DION		SUI - SWITZERLAND
9	MESSAHEL WAEL ABDELKADER		ALG - ALGERIA

KUMITE MALE U16 -57KG

Lion Cup 2024 Luxembourg

ENTRIES BY WEIGHT CATEGORY
Kumite Male U16 -57kg

As of 8 JUN 2024

NOC Code	Gender	Name	Seeding
BEL	M	Bourlard Lenny	
BEL	M	KONRADOWSKI ANDREAS	
BEL	M	QUARANTA CALOGERO	
LUX	M	AGOSTINO Enzo	
NED	M	Kashash Thaer	
NED	M	Kong Jeremy	
NED	M	Lepez Devon	
NED	M	Persaud Maxim	
NED	M	Saeijs Benjamin	
NED	M	Van Wijngaarden Tygo	
NOR	M	Hansen Martin Walstad	
SCO	M	Morrison Logan	
SUI	M	Soliaryk Platon	

Kumite Male U16 -57kg

Lion Cup 2024 Luxembourg, 297 Rue de Reckenthal L-2410 Strassen, LUX

2024-06-08

Tatami
4 16:40

Pool
1 / 1

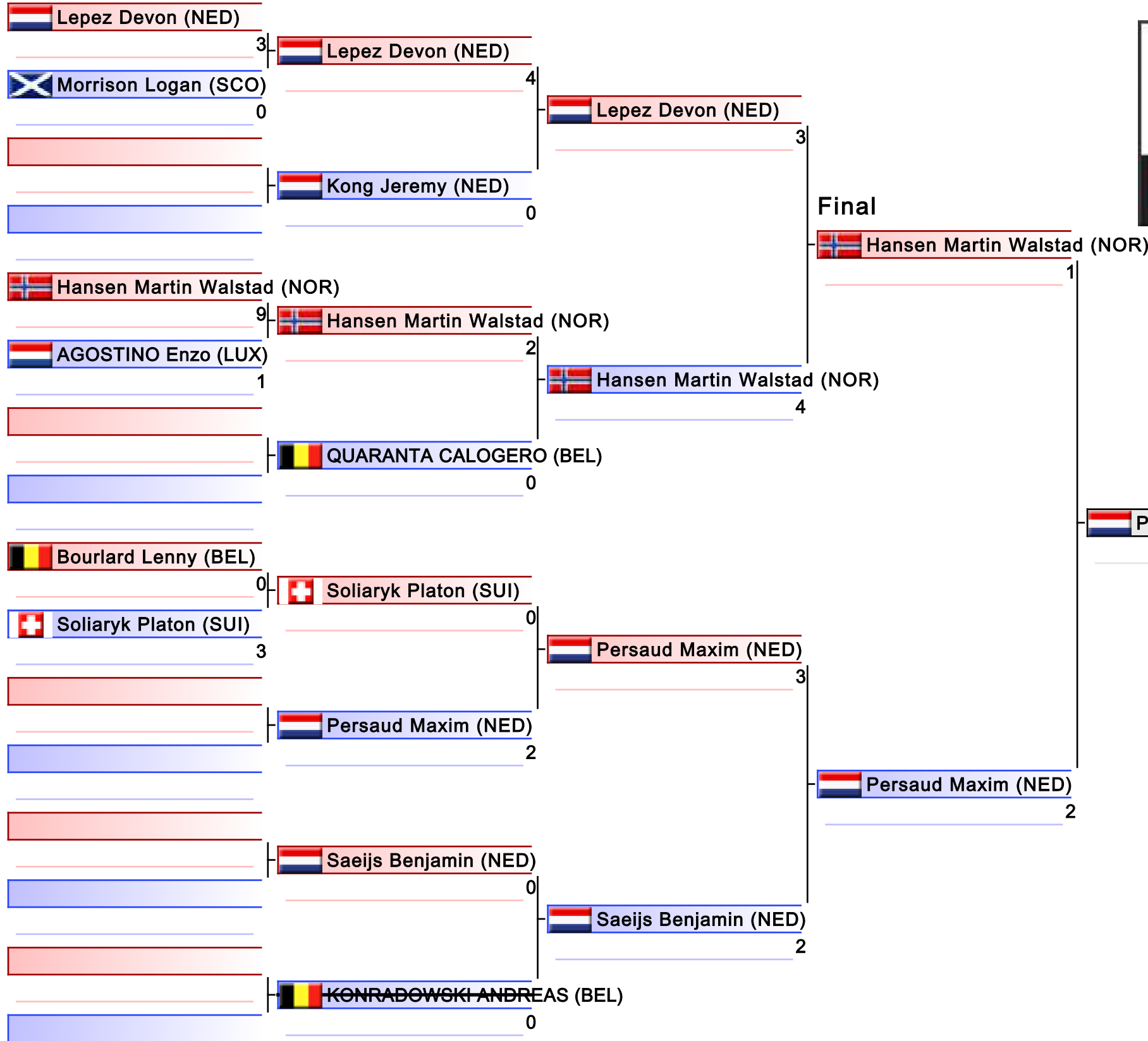

1. PERSAUD MAXIM (NED)
2. HANSEN MARTIN WALSTAD (NOR)
3. SAEIJS BENJAMIN (NED)
3. LEPEZ DEVON (NED)
5. SOLIARYK PLATON (SUI)
5. QUARANTA CALOGERO (BEL)
7. AGOSTINO ENZO (LUX)

Kumite Male U16 -57kg

Lion Cup 2024 Luxembourg

2024-06-08 4 17:25 Tatami Pool 1

(c)sportdata GmbH & Co KG 2000-2024 (2024-06-08 18:41) v 10.1.0 build 1 (2024-01-24 23:23 CET) License: Online_Event_ID-7672_LionCup2024Luxembourg (expire 2024-06-21)

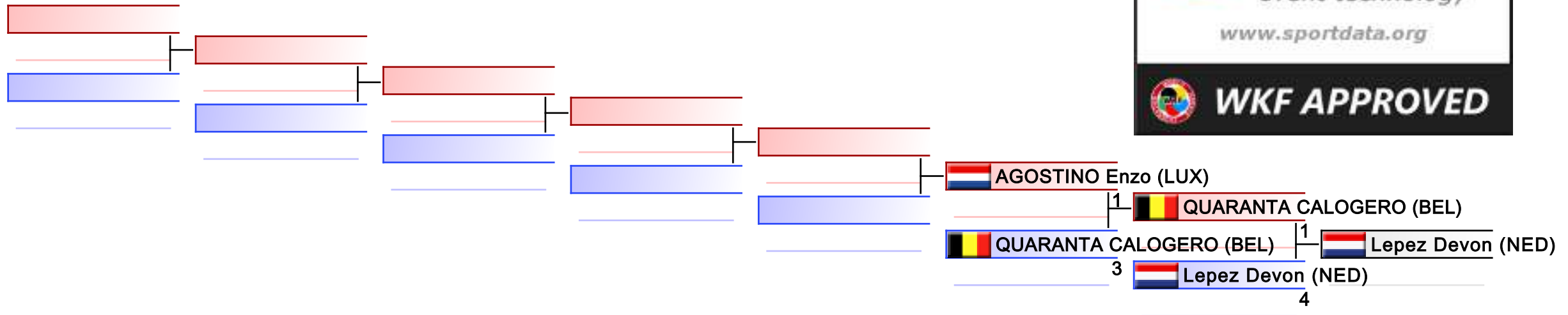

REPECHAGE: (1)

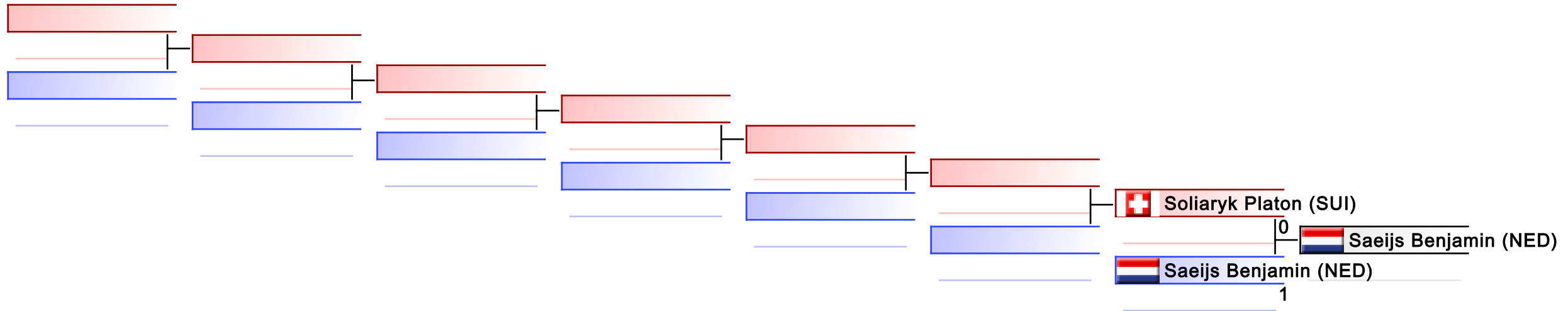

Lion Cup 2024 Luxembourg

297 Rue de Reckenthal L-2410 Strassen, LUXEMBOURG

Court Nr.	1	Pool	1	Date	2024-06-08	Field Position	49
RED				BLUE			
NOC	LEPEZ DEVON (NED)			NOC	MORRISON LOGAN (SCO)		
Category	Kumite Male U16 -57kg						
3 Points	2 Points	1 Point	Score	1 Point	2 Points	3 Points	
			3 : 0				
Penatlity				Penatlity			
C1: C2, C2:				3:0	C1: C1, C2:		
WINNER				Total			

Decision of Superiority

Judge 1	Judge 2	Judge 3	Judge 4	Judge 5	Judge 6	Judge 7	Referee

Name _____

Signature _____

Lion Cup 2024 Luxembourg

297 Rue de Reckenthal L-2410 Strassen, LUXEMBOURG

Court Nr.	1	Pool	1	Date	2024-06-08	Field Position	51
RED				BLUE			
NOC	HANSEN MARTIN WALSTAD (NOR)			NOC	AGOSTINO ENZO (LUX)		
Category	Kumite Male U16 -57kg						
3 Points	2 Points	1 Point	Score	1 Point	2 Points	3 Points	
			9 : 1				
Penatlity				Penatlity			
C1: , C2:				9:1	C1: , C2:		
WINNER				Total			

Decision of Superiority

Judge 1	Judge 2	Judge 3	Judge 4	Judge 5	Judge 6	Judge 7	Referee

Name _____

Signature _____

Lion Cup 2024 Luxembourg

297 Rue de Reckenthal L-2410 Strassen, LUXEMBOURG

Court Nr.	1	Pool	1	Date	2024-06-08	Field Position	53
RED				BLUE			
NOC	BOURLARD LENNY (BEL)			NOC	SOLIARYK PLATON (SUI)		
Category	Kumite Male U16 -57kg						
3 Points	2 Points	1 Point	Score	1 Point	2 Points	3 Points	
			0 : 3				
Penatlity				Penatlity			
C1: , C2:				0:3	C1: , C2:		
				Total	WINNER		

Decision of Superiority

Judge 1	Judge 2	Judge 3	Judge 4	Judge 5	Judge 6	Judge 7	Referee

Name _____

Signature _____

Lion Cup 2024 Luxembourg

297 Rue de Reckenthal L-2410 Strassen, LUXEMBOURG

Court Nr.	1	Pool	1	Date	2024-06-08	Field Position	57	
RED				BLUE				
NOC	LEPEZ DEVON (NED)			NOC	KONG JEREMY (NED)			
Category	Kumite Male U16 -57kg							
3 Points	2 Points	1 Point	Score	1 Point	2 Points	3 Points		
			4 : 0					
Penatlity				Penatlity				
C1: HC, C2:				4:0	C1: C1, C2:			
WINNER				Total				

Decision of Superiority

Judge 1	Judge 2	Judge 3	Judge 4	Judge 5	Judge 6	Judge 7	Referee

Name _____

Signature _____

Lion Cup 2024 Luxembourg

297 Rue de Reckenthal L-2410 Strassen, LUXEMBOURG

Court Nr.	1	Pool	1	Date	2024-06-08	Field Position	58	
RED				BLUE				
NOC	HANSEN MARTIN WALSTAD (NOR)			NOC	QUARANTA CALOGERO (BEL)			
Category	Kumite Male U16 -57kg							
3 Points	2 Points	1 Point	Score	1 Point	2 Points	3 Points		
			2 : 0					
Penatlity				Penatlity				
C1: HC, C2:				2:0	C1: C2, C2:			
WINNER				Total				

Decision of Superiority

Judge 1	Judge 2	Judge 3	Judge 4	Judge 5	Judge 6	Judge 7	Referee

Name _____

Signature _____

Lion Cup 2024 Luxembourg

297 Rue de Reckenthal L-2410 Strassen, LUXEMBOURG

Court Nr.	1	Pool	1	Date	2024-06-08	Field Position	59
RED				BLUE			
NOC	SOLIARYK PLATON (SUI)			NOC	PERSAUD MAXIM (NED)		
Category	Kumite Male U16 -57kg						
3 Points	2 Points	1 Point	Score	1 Point	2 Points	3 Points	
			0 : 2				
Penatlity				Penatlity			
C1: C1, C2:				0:2	C1: C1, C2:		
				Total	WINNER		

Decision of Superiority

Judge 1	Judge 2	Judge 3	Judge 4	Judge 5	Judge 6	Judge 7	Referee

Name _____

Signature _____

Lion Cup 2024 Luxembourg

297 Rue de Reckenthal L-2410 Strassen, LUXEMBOURG

Court Nr.	1	Pool	1	Date	2024-06-08	Field Position	61
RED				BLUE			
NOC	LEPEZ DEVON (NED)			NOC	HANSEN MARTIN WALSTAD (NOR)		
Category	Kumite Male U16 -57kg						
3 Points	2 Points	1 Point	Score	1 Point	2 Points	3 Points	
			3 : 4				
Penatlity				Penatlity			
C1: C1, C2:			3:4	C1: HC, C2:			
			Total	WINNER			

Decision of Superiority

Judge 1	Judge 2	Judge 3	Judge 4	Judge 5	Judge 6	Judge 7	Referee

Name _____

Signature _____

Lion Cup 2024 Luxembourg

297 Rue de Reckenthal L-2410 Strassen, LUXEMBOURG

Court Nr.	1	Pool	1	Date	2024-06-08	Field Position	62
RED				BLUE			
NOC	PERSAUD MAXIM (NED)			NOC	SAEIJS BENJAMIN (NED)		
Category	Kumite Male U16 -57kg						
3 Points	2 Points	1 Point	Score	1 Point	2 Points	3 Points	
			3 : 2				
Penatlity					Penatlity		
C1: C1, C2:				3:2	C1: C1, C2:		
WINNER				Total			

Decision of Superiority

Judge 1	Judge 2	Judge 3	Judge 4	Judge 5	Judge 6	Judge 7	Referee

Name _____

Signature _____

Lion Cup 2024 Luxembourg

297 Rue de Reckenthal L-2410 Strassen, LUXEMBOURG

Court Nr.	1	Pool	1	Date	2024-06-08	Field Position	63
RED				BLUE			
NOC	HANSEN MARTIN WALSTAD (NOR)			NOC	PERSAUD MAXIM (NED)		
Category	Kumite Male U16 -57kg						
3 Points	2 Points	1 Point	Score	1 Point	2 Points	3 Points	
			1 : 2				
Penatlity					Penatlity		
C1: C1, C2:				1:2	C1: C3, C2:		
				Total	WINNER		

Decision of Superiority

Judge 1	Judge 2	Judge 3	Judge 4	Judge 5	Judge 6	Judge 7	Referee

Name _____

Signature _____

Lion Cup 2024 Luxembourg

297 Rue de Reckenthal L-2410 Strassen, LUXEMBOURG

Court Nr.	1	Pool	1	Date	2024-06-08	Field Position	0
RED				BLUE			
NOC	QUARANTA CALOGERO (BEL)			NOC	LEPEZ DEVON (NED)		
Category	Kumite Male U16 -57kg						
3 Points	2 Points	1 Point	Score	1 Point	2 Points	3 Points	
			1 : 4				
Penatlity				Penatlity			
C1: C1, C2:				1:4	C1: , C2:		
				Total	WINNER		

Decision of Superiority

Judge 1	Judge 2	Judge 3	Judge 4	Judge 5	Judge 6	Judge 7	Referee

Name _____

Signature _____

Lion Cup 2024 Luxembourg

297 Rue de Reckenthal L-2410 Strassen, LUXEMBOURG

Court Nr.	1	Pool	1	Date	2024-06-08	Field Position	2
RED				BLUE			
NOC	AGOSTINO ENZO (LUX)			NOC	QUARANTA CALOGERO (BEL)		
Category	Kumite Male U16 -57kg						
3 Points	2 Points	1 Point	Score	1 Point	2 Points	3 Points	
			:				
Penatlity				Penatlity			
			Total				

Decision of Superiority

Judge 1	Judge 2	Judge 3	Judge 4	Judge 5	Judge 6	Judge 7	Referee

Name _____

Signature _____

Lion Cup 2024 Luxembourg

297 Rue de Reckenthal L-2410 Strassen, LUXEMBOURG

Court Nr.	2	Pool	2	Date	2024-06-08	Field Position	0
RED				BLUE			
NOC	SOLIARYK PLATON (SUI)			NOC	SAEIJS BENJAMIN (NED)		
Category	Kumite Male U16 -57kg						
3 Points	2 Points	1 Point	Score	1 Point	2 Points	3 Points	
			0 : 1				
Penatlity				Penatlity			
C1: , C2:				0:1	C1: , C2:		
				Total	WINNER		

Decision of Superiority

Judge 1	Judge 2	Judge 3	Judge 4	Judge 5	Judge 6	Judge 7	Referee

Name _____

Signature _____

Lion Cup 2024 Luxembourg - 2024-06-07

Official Results

Kumite Male U16 -57kg			
1	PERSAUD MAXIM		NED - NETHERLANDS
2	HANSEN MARTIN WALSTAD		NOR - NORWAY
3	SAEIJIS BENJAMIN		NED - NETHERLANDS
3	LEPEZ DEVON		NED - NETHERLANDS
5	SOLIARYK PLATON		SUI - SWITZERLAND
5	QUARANTA CALOGERO		BEL - BELGIUM
7	AGOSTINO ENZO		LUX - LUXEMBOURG

KUMITE MALE U16 -63KG

Lion Cup 2024 Luxembourg

ENTRIES BY WEIGHT CATEGORY
Kumite Male U16 -63kg

As of 8 JUN 2024

NOC Code	Gender	Name	Seeding
AUT	M	CHEBAN Oleksandr	
BEL	M	Dendas rigo	
BEL	M	Mrhani Mehdi	
BEL	M	ZOUEINI Rayan	
FRA	M	PAULET Lucas	
LUX	M	Fecchi Matteo	
LUX	M	TIZOURINE Massi	
LUX	M	Todorovic Filip	
NED	M	Bezemer Bradley	
NED	M	Kashash Thaer	
NOR	M	Fagerli Demian	
SUI	M	Poncet Arthur	
SUI	M	Roncagalli Elia	
SUI	M	Sieber Elija	

Kumite Male U16 -63kg

Lion Cup 2024 Luxembourg, 297 Rue de Reckenthal L-2410 Strassen, LUX

2024-06-08

Tatami
1 15:50

Pool
1 / 1

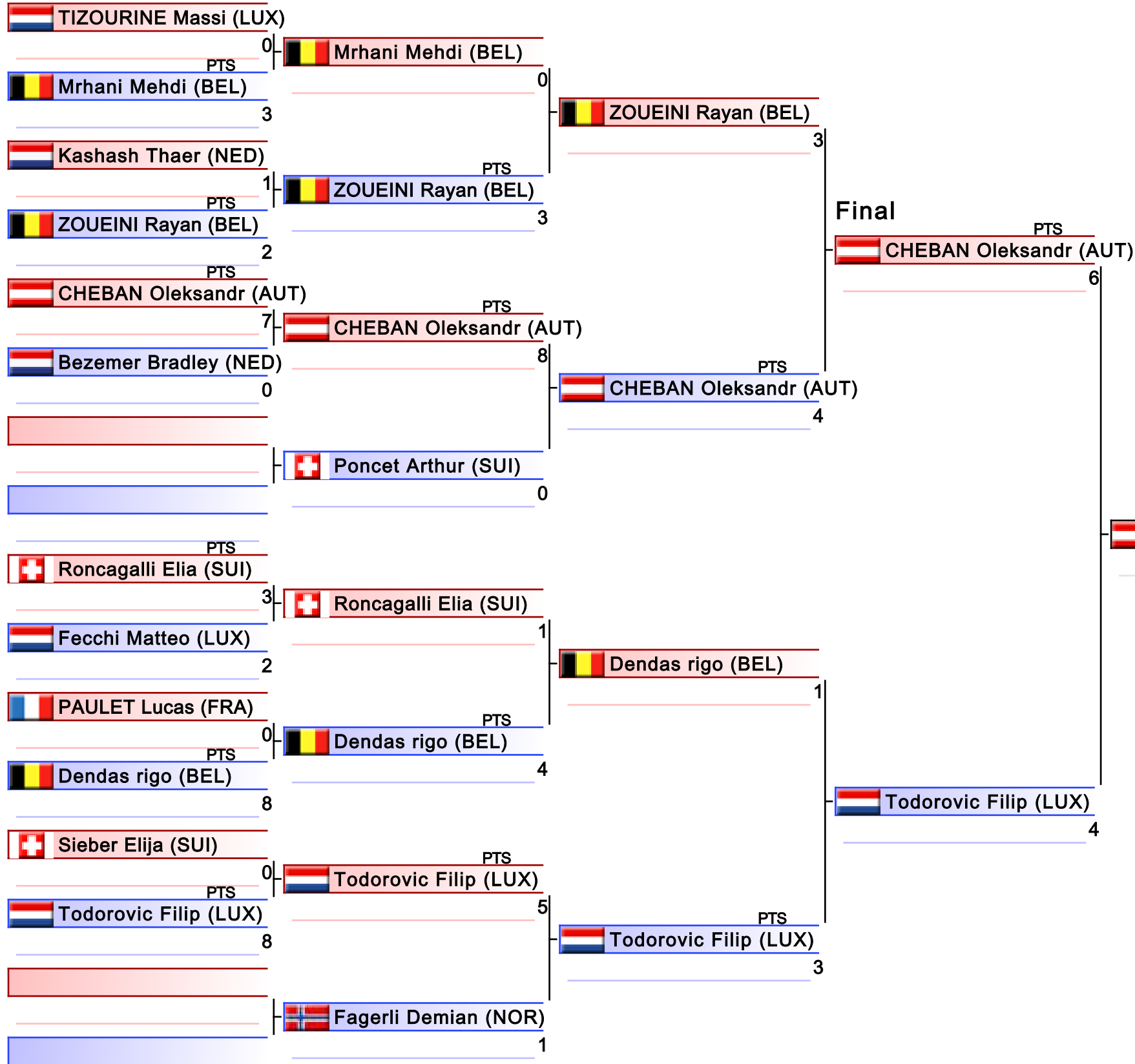

1. CHEBAN OLEKSANDR (AUT)
2. TODOROVIC FILIP (LUX)
3. ZOUEINI RAYAN (BEL)
3. SIEBER ELIJA (SUI)
5. PONCET ARTHUR (SUI)
5. DENDAS RIGO (BEL)
7. BEZEMER BRADLEY (NED)
7. FAGERLI DEMIAN (NOR)

Kumite Male U16 -63kg

Lion Cup 2024 Luxembourg

2024-06-08

Tatami
1 16:40

Pool
1

(c)sportdata GmbH & Co KG 2000-2024 (2024-06-08 18:41) v 10.1.0 build 1 (2024-01-24 23:23 CET) License: Online_Event_ID-7672_LionCup2024Luxembourg (expire 2024-06-21)

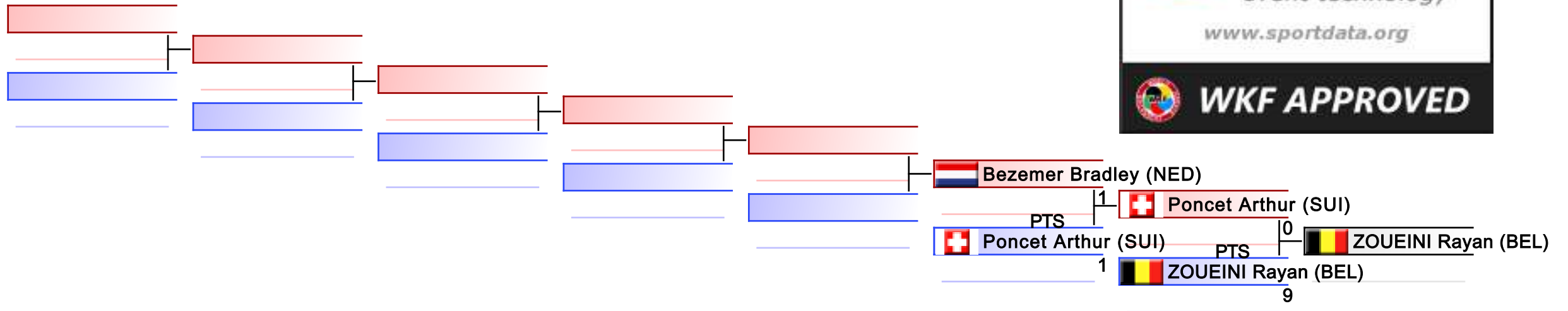

REPECHAGE: (1)

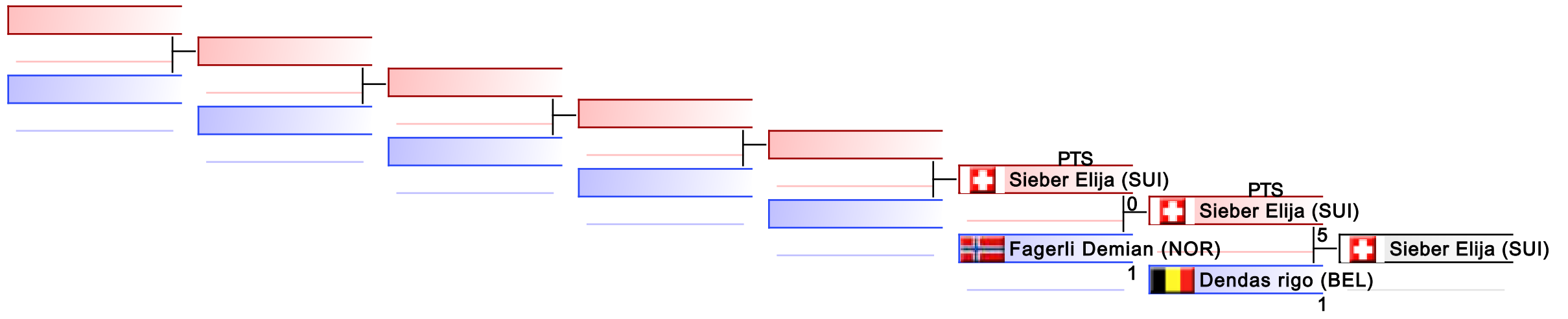

Lion Cup 2024 Luxembourg

297 Rue de Reckenthal L-2410 Strassen, LUXEMBOURG

Court Nr.	1	Pool	1	Date	2024-06-08	Field Position	49	
RED				BLUE				
NOC	TIZOURINE MASSI (LUX)			NOC	MRHANI MEHDI (BEL)			
Category	Kumite Male U16 -63kg							
3 Points	2 Points	1 Point	Score	1 Point	2 Points	3 Points		
			0 : 3					
Penatlity				Penatlity				
C1: C1, C2:				0:3	C1: HC, C2:			
				Total	WINNER			

PTS

Decision of Superiority

Judge 1	Judge 2	Judge 3	Judge 4	Judge 5	Judge 6	Judge 7	Referee

Name _____

Signature _____

Lion Cup 2024 Luxembourg

297 Rue de Reckenthal L-2410 Strassen, LUXEMBOURG

Court Nr.	1	Pool	1	Date	2024-06-08	Field Position	50
RED				BLUE			
NOC	KASHASH THAER (NED)			NOC	ZOUENI RAYAN (BEL)		
Category	Kumite Male U16 -63kg						
3 Points	2 Points	1 Point	Score	1 Point	2 Points	3 Points	
			1 : 2				
Penatlity				Penatlity			
C1: C2, C2:				1:2	C1: C1, C2:		
				Total	WINNER		

PTS

Decision of Superiority

Judge 1	Judge 2	Judge 3	Judge 4	Judge 5	Judge 6	Judge 7	Referee

Name _____

Signature _____

Lion Cup 2024 Luxembourg

297 Rue de Reckenthal L-2410 Strassen, LUXEMBOURG

Court Nr.	1	Pool	1	Date	2024-06-08	Field Position	51	
RED				BLUE				
NOC	CHEBAN OLEKSANDR (AUT)			NOC	BEZEMER BRADLEY (NED)			
Category	Kumite Male U16 -63kg							
3 Points	2 Points	1 Point	Score	1 Point	2 Points	3 Points		
			7 : 0					
Penatlity				Penatlity				
C1: , C2:				7:0	C1: C2, C2:			
WINNER				Total				

PTS

Decision of Superiority

Judge 1	Judge 2	Judge 3	Judge 4	Judge 5	Judge 6	Judge 7	Referee

Name _____

Signature _____

Lion Cup 2024 Luxembourg

297 Rue de Reckenthal L-2410 Strassen, LUXEMBOURG

Court Nr.	1	Pool	1	Date	2024-06-08	Field Position	53
RED				BLUE			
NOC	RONCAGALLI ELIA (SUI)			NOC	FECCHI MATTEO (LUX)		
Category	Kumite Male U16 -63kg						
3 Points	2 Points	1 Point	Score	1 Point	2 Points	3 Points	
			3 : 2				
Penatlity				Penatlity			
C1: , C2:				3:2	C1: , C2:		
WINNER				Total			

PTS

Decision of Superiority

Judge 1	Judge 2	Judge 3	Judge 4	Judge 5	Judge 6	Judge 7	Referee

Name _____

Signature _____

Lion Cup 2024 Luxembourg

297 Rue de Reckenthal L-2410 Strassen, LUXEMBOURG

Court Nr.	1	Pool	1	Date	2024-06-08	Field Position	54
RED				BLUE			
NOC	PAULET LUCAS (FRA)			NOC	DENDAS RIGO (BEL)		
Category	Kumite Male U16 -63kg						
3 Points	2 Points	1 Point	Score	1 Point	2 Points	3 Points	
			0 : 8				
Penatlity				Penatlity			
C1: C1, C2:			0:8	C1: C2, C2:			
			Total	WINNER			

PTS

Decision of Superiority

Judge 1	Judge 2	Judge 3	Judge 4	Judge 5	Judge 6	Judge 7	Referee

Name _____

Signature _____

Lion Cup 2024 Luxembourg

297 Rue de Reckenthal L-2410 Strassen, LUXEMBOURG

Court Nr.	1	Pool	1	Date	2024-06-08	Field Position	55	
RED				BLUE				
NOC	SIEBER ELIJA (SUI)			NOC	TODOROVIC FILIP (LUX)			
Category	Kumite Male U16 -63kg							
3 Points	2 Points	1 Point	Score	1 Point	2 Points	3 Points		
			0 : 8					
Penatlity				Penatlity				
C1: C1, C2:				0:8	C1: C1, C2:			
				Total	WINNER			

PTS

Decision of Superiority

Judge 1	Judge 2	Judge 3	Judge 4	Judge 5	Judge 6	Judge 7	Referee

Name _____

Signature _____

Lion Cup 2024 Luxembourg

297 Rue de Reckenthal L-2410 Strassen, LUXEMBOURG

Court Nr.	1	Pool	1	Date	2024-06-08	Field Position	57	
RED				BLUE				
NOC	MRHANI MEHDI (BEL)			NOC	ZOUENI RAYAN (BEL)			
Category	Kumite Male U16 -63kg							
3 Points	2 Points	1 Point	Score	1 Point	2 Points	3 Points		
			0 : 3					
Penatlity				Penatlity				
C1: C2, C2:				0:3	C1: C1, C2:			
				Total	WINNER			

PTS

Decision of Superiority

Judge 1	Judge 2	Judge 3	Judge 4	Judge 5	Judge 6	Judge 7	Referee

Name _____

Signature _____

Lion Cup 2024 Luxembourg

297 Rue de Reckenthal L-2410 Strassen, LUXEMBOURG

Court Nr.	1	Pool	1	Date	2024-06-08	Field Position	58	
RED				BLUE				
NOC	CHEBAN OLEKSANDR (AUT)			NOC	PONCET ARTHUR (SUI)			
Category	Kumite Male U16 -63kg							
3 Points	2 Points	1 Point	Score	1 Point	2 Points	3 Points		
			8 : 0					
Penatlity				Penatlity				
C1: , C2:				8:0	C1: , C2:			
WINNER				Total				

PTS

Decision of Superiority

Judge 1	Judge 2	Judge 3	Judge 4	Judge 5	Judge 6	Judge 7	Referee

Name _____

Signature _____

Lion Cup 2024 Luxembourg

297 Rue de Reckenthal L-2410 Strassen, LUXEMBOURG

Court Nr.	1	Pool	1	Date	2024-06-08	Field Position	59	
RED				BLUE				
NOC	RONCAGALLI ELIA (SUI)			NOC	DENDAS RIGO (BEL)			
Category	Kumite Male U16 -63kg							
3 Points	2 Points	1 Point	Score	1 Point	2 Points	3 Points		
			1 : 4					
Penatlity				Penatlity				
C1: C2, C2:				1:4	C1: HC, C2:			
				Total	WINNER			

PTS

Decision of Superiority

Judge 1	Judge 2	Judge 3	Judge 4	Judge 5	Judge 6	Judge 7	Referee

Name _____

Signature _____

Lion Cup 2024 Luxembourg

297 Rue de Reckenthal L-2410 Strassen, LUXEMBOURG

Court Nr.	1	Pool	1	Date	2024-06-08	Field Position	60
RED				BLUE			
NOC	TODOROVIC FILIP (LUX)			NOC	FAGERLI DEMIAN (NOR)		
Category	Kumite Male U16 -63kg						
3 Points	2 Points	1 Point	Score	1 Point	2 Points	3 Points	
			5 : 1				
Penatlity					Penatlity		
C1: C1, C2:				5:1	C1: , C2:		
WINNER				Total			

PTS

Decision of Superiority

Judge 1	Judge 2	Judge 3	Judge 4	Judge 5	Judge 6	Judge 7	Referee

Name _____

Signature _____

Lion Cup 2024 Luxembourg

297 Rue de Reckenthal L-2410 Strassen, LUXEMBOURG

Court Nr.	1	Pool	1	Date	2024-06-08	Field Position	61
RED				BLUE			
NOC	ZOUENI RAYAN (BEL)			NOC	CHEBAN OLEKSANDR (AUT)		
Category	Kumite Male U16 -63kg						
3 Points	2 Points	1 Point	Score	1 Point	2 Points	3 Points	
			3 : 4				
Penatlity				Penatlity			
C1: , C2:				3:4	C1: HC, C2:		
				Total	WINNER		

PTS

Decision of Superiority

Judge 1	Judge 2	Judge 3	Judge 4	Judge 5	Judge 6	Judge 7	Referee

Name _____

Signature _____

Lion Cup 2024 Luxembourg

297 Rue de Reckenthal L-2410 Strassen, LUXEMBOURG

Court Nr.	1	Pool	1	Date	2024-06-08	Field Position	62	
RED				BLUE				
NOC	DENDAS RIGO (BEL)			NOC	TODOROVIC FILIP (LUX)			
Category	Kumite Male U16 -63kg							
3 Points	2 Points	1 Point	Score	1 Point	2 Points	3 Points		
			1 : 3					
Penatlity				Penatlity				
C1: C2, C2:				1:3	C1: C2, C2:			
				Total	WINNER			

PTS

Decision of Superiority

Judge 1	Judge 2	Judge 3	Judge 4	Judge 5	Judge 6	Judge 7	Referee

Name _____

Signature _____

Lion Cup 2024 Luxembourg

297 Rue de Reckenthal L-2410 Strassen, LUXEMBOURG

Court Nr.	1	Pool	1	Date	2024-06-08	Field Position	63	
RED				BLUE				
NOC	CHEBAN OLEKSANDR (AUT)			NOC	TODOROVIC FILIP (LUX)			
Category	Kumite Male U16 -63kg							
3 Points	2 Points	1 Point	Score	1 Point	2 Points	3 Points		
			6 : 4					
Penatlity				Penatlity				
C1: HC, C2:				6:4	C1: C1, C2:			
WINNER				Total				

PTS

Decision of Superiority

Judge 1	Judge 2	Judge 3	Judge 4	Judge 5	Judge 6	Judge 7	Referee

Name _____

Signature _____

Lion Cup 2024 Luxembourg

297 Rue de Reckenthal L-2410 Strassen, LUXEMBOURG

Court Nr.	1	Pool	1	Date	2024-06-08	Field Position	0
RED				BLUE			
NOC	PONCET ARTHUR (SUI)			NOC	ZOUENI RAYAN (BEL)		
Category	Kumite Male U16 -63kg						
3 Points	2 Points	1 Point	Score	1 Point	2 Points	3 Points	
			0 : 9				
Penatlity				Penatlity			
C1: , C2:				0:9	C1: C2, C2:		
				Total	WINNER		

PTS

Decision of Superiority

Judge 1	Judge 2	Judge 3	Judge 4	Judge 5	Judge 6	Judge 7	Referee

Name _____

Signature _____

Lion Cup 2024 Luxembourg

297 Rue de Reckenthal L-2410 Strassen, LUXEMBOURG

Court Nr.	1	Pool	1	Date	2024-06-08	Field Position	2
RED				BLUE			
NOC	BEZEMER BRADLEY (NED)			NOC	PONCET ARTHUR (SUI)		
Category	Kumite Male U16 -63kg						
3 Points	2 Points	1 Point	Score	1 Point	2 Points	3 Points	
			:				
Penatlity				Penatlity			
			Total				

Decision of Superiority

Judge 1	Judge 2	Judge 3	Judge 4	Judge 5	Judge 6	Judge 7	Referee

Name _____

Signature _____

Lion Cup 2024 Luxembourg

297 Rue de Reckenthal L-2410 Strassen, LUXEMBOURG

Court Nr.	2	Pool	2	Date	2024-06-08	Field Position	0
RED				BLUE			
NOC	SIEBER ELIJA (SUI)			NOC	DENDAS RIGO (BEL)		
Category	Kumite Male U16 -63kg						
3 Points	2 Points	1 Point	Score	1 Point	2 Points	3 Points	
			5 : 1				
Penatlity				Penatlity			
C1: HC, C2:			5:1	C1: HC, C2:			
WINNER			Total				

PTS

Decision of Superiority

Judge 1	Judge 2	Judge 3	Judge 4	Judge 5	Judge 6	Judge 7	Referee

Name _____

Signature _____

Lion Cup 2024 Luxembourg

297 Rue de Reckenthal L-2410 Strassen, LUXEMBOURG

Court Nr.	2	Pool	2	Date	2024-06-08	Field Position	2	
RED				BLUE				
NOC	SIEBER ELIJA (SUI)			NOC	FAGERLI DEMIAN (NOR)			
Category	Kumite Male U16 -63kg							
3 Points	2 Points	1 Point	Score	1 Point	2 Points	3 Points		
			0 : 1					
Penatlity				Penatlity				
C1: C1, C2:				0:1	C1: H, C2:			
WINNER				Total				

PTS

Decision of Superiority

Judge 1	Judge 2	Judge 3	Judge 4	Judge 5	Judge 6	Judge 7	Referee

Name _____

Signature _____

Official Results

Kumite Male U16 -63kg			
1	CHEBAN OLEKSANDR		AUT - AUSTRIA
2	TODOROVIC FILIP		LUX - LUXEMBOURG
3	ZOUEINI RAYAN		BEL - BELGIUM
3	SIEBER ELIJA		SUI - SWITZERLAND
5	PONCET ARTHUR		SUI - SWITZERLAND
5	DENDAS RIGO		BEL - BELGIUM
7	BEZEMER BRADLEY		NED - NETHERLANDS
7	FAGERLI DEMIAN		NOR - NORWAY

KUMITE MALE U16 -70KG

Lion Cup 2024 Luxembourg

ENTRIES BY WEIGHT CATEGORY
Kumite Male U16 -70kg

As of 8 JUN 2024

NOC Code	Gender	Name	Seeding
BEL	M	Bauweraerts Luca	
BEL	M	Cucciniello Enzo	
BEL	M	De Wilde Senne	
BEL	M	El-Aidi Yahya	
BEL	M	Sautelet Arthur	
IRL	M	Heneghan Alex	
LUX	M	Nedioglo Dimitrii	
LUX	M	Pierantoni Matteo	
NED	M	Blumink Levy	
NED	M	van Kruining Flynn	
SUI	M	Dos Santos Samuel	

Kumite Male U16 -70kg

Lion Cup 2024 Luxembourg, 297 Rue de Reckenthal L-2410 Strassen, LUX

2024-06-08

Tatami
4 15:45

Pool
1 / 1

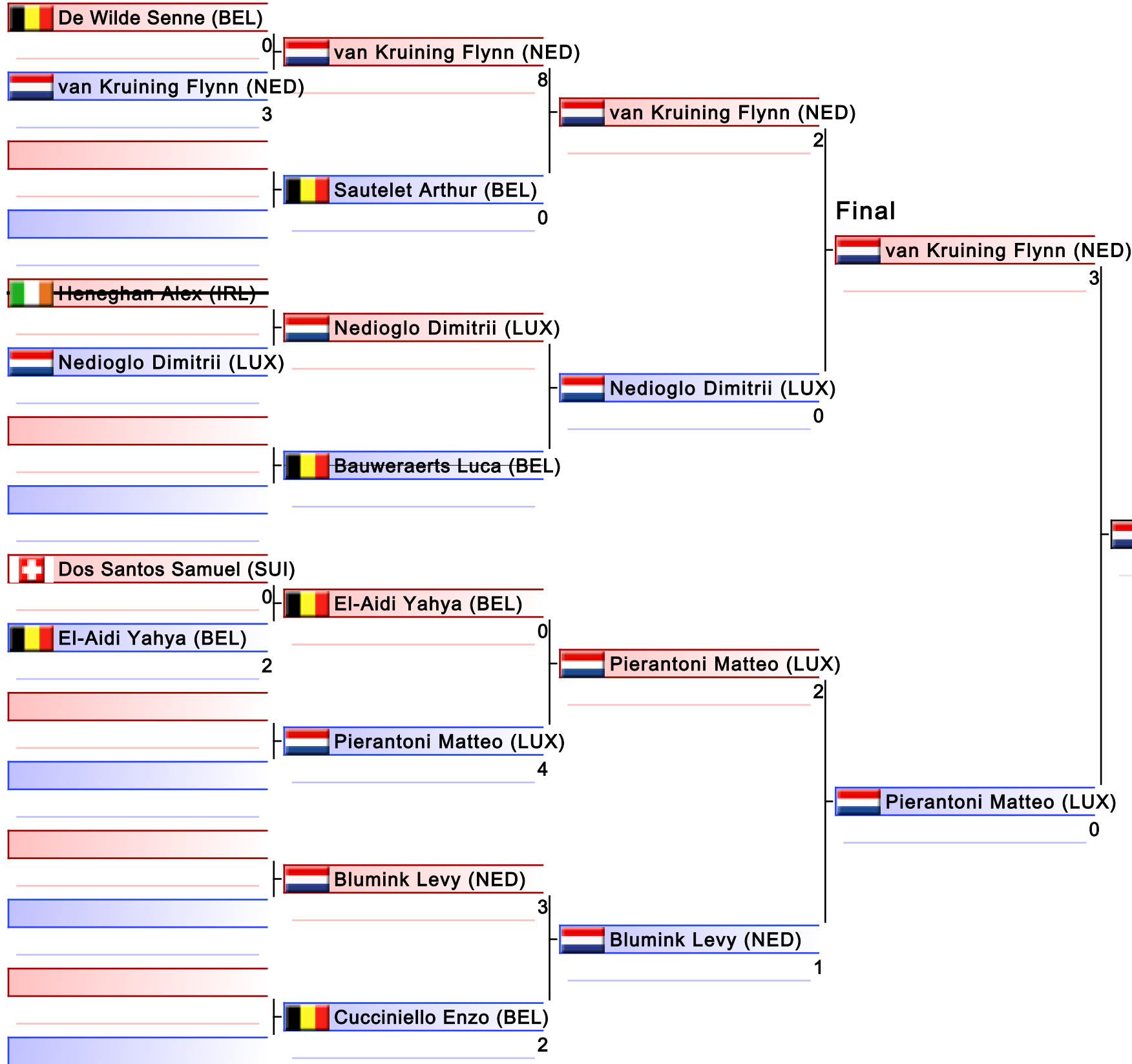

1. VAN KRUINING FLYNN (NED)
2. PIERANTONI MATTEO (LUX)
3. NEDIOGLO DIMITRII (LUX)
3. BLUMINK LEVY (NED)
5. SAUTELET ARTHUR (BEL)
5. EL-AIDI YAHYA (BEL)
7. DE WILDE SENNE (BEL)

Kumite Male U16 -70kg

Lion Cup 2024 Luxembourg

2024-06-08

Tatami 4 16:20

Pool 1

(c)sportdata GmbH & Co KG 2000-2024 (2024-06-08 18:41) v 10.1.0 build 1 (2024-01-24 23:23 CET) License: Online_Event_ID-7672_LionCup2024Luxembourg (expire 2024-06-21)

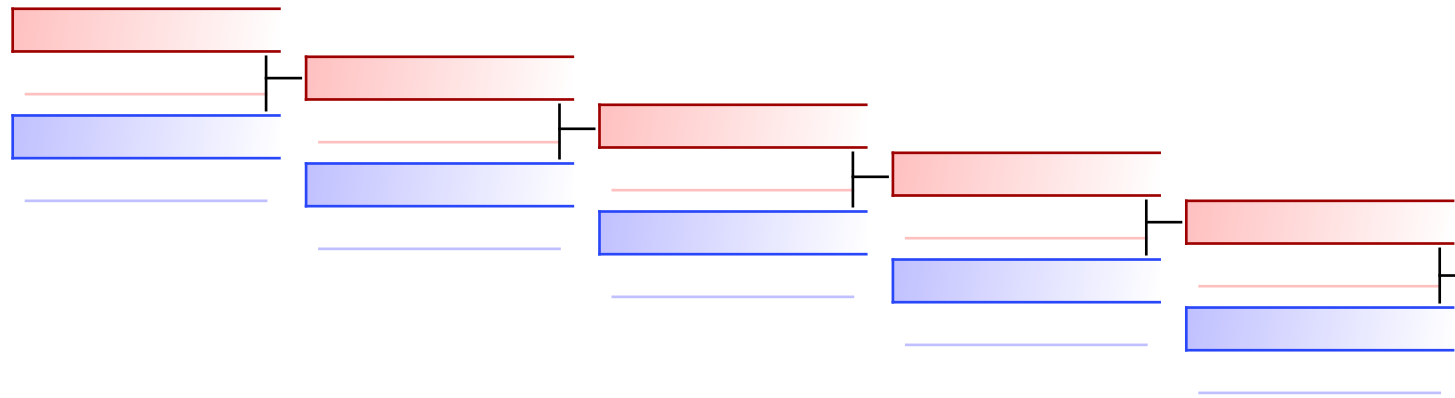

De Wilde Senne (BEL)	0	Sautelet Arthur (BEL)	2
Sautelet Arthur (BEL)	0	Nedioglo Dimitrii (LUX)	6

REPECHAGE: (1)

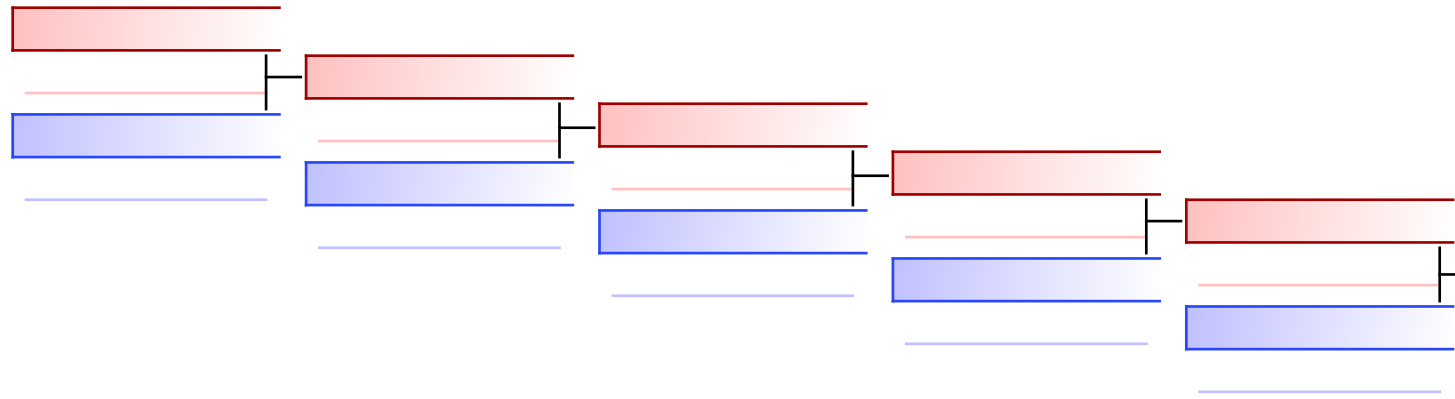

El-Aidi Yahya (BEL)	2	Blumink Levy (NED)	4
Blumink Levy (NED)	4		

Lion Cup 2024 Luxembourg

297 Rue de Reckenthal L-2410 Strassen, LUXEMBOURG

Court Nr.	1	Pool	1	Date	2024-06-08	Field Position	49
RED				BLUE			
NOC	DE WILDE SENNE (BEL)			NOC	VAN KRUIING FLYNN (NED)		
Category	Kumite Male U16 -70kg						
3 Points	2 Points	1 Point	Score	1 Point	2 Points	3 Points	
			0 : 3				
Penatlity				Penatlity			
C1: , C2:				0:3	C1: C3, C2:		
				Total	WINNER		

Decision of Superiority

Judge 1	Judge 2	Judge 3	Judge 4	Judge 5	Judge 6	Judge 7	Referee

Name _____

Signature _____

Lion Cup 2024 Luxembourg

297 Rue de Reckenthal L-2410 Strassen, LUXEMBOURG

Court Nr.	1	Pool	1	Date	2024-06-08	Field Position	53
RED				BLUE			
NOC	DOS SANTOS SAMUEL (SUI)			NOC	EL-AIDI YAHYA (BEL)		
Category	Kumite Male U16 -70kg						
3 Points	2 Points	1 Point	Score	1 Point	2 Points	3 Points	
			0 : 2				
Penatlity				Penatlity			
C1: , C2:			0:2	C1: C1, C2:			
			Total	WINNER			

Decision of Superiority

Judge 1	Judge 2	Judge 3	Judge 4	Judge 5	Judge 6	Judge 7	Referee

Name _____

Signature _____

Lion Cup 2024 Luxembourg

297 Rue de Reckenthal L-2410 Strassen, LUXEMBOURG

Court Nr.	1	Pool	1	Date	2024-06-08	Field Position	57
RED				BLUE			
NOC	VAN KRUINING FLYNN (NED)			NOC	SAUTELET ARTHUR (BEL)		
Category	Kumite Male U16 -70kg						
3 Points	2 Points	1 Point	Score	1 Point	2 Points	3 Points	
			8 : 0				
Penatlity				Penatlity			
C1: HC, C2:			8:0	C1: C1, C2:			
WINNER			Total				

Decision of Superiority

Judge 1	Judge 2	Judge 3	Judge 4	Judge 5	Judge 6	Judge 7	Referee

Name _____

Signature _____

Lion Cup 2024 Luxembourg

297 Rue de Reckenthal L-2410 Strassen, LUXEMBOURG

Court Nr.	1	Pool	1	Date	2024-06-08	Field Position	59
RED				BLUE			
NOC	EL-AIDI YAHYA (BEL)			NOC	PIERANTONI MATTEO (LUX)		
Category	Kumite Male U16 -70kg						
3 Points	2 Points	1 Point	Score	1 Point	2 Points	3 Points	
			0 : 4				
Penatlity				Penatlity			
C1: C2, C2:			0:4	C1: HC, C2:			
			Total	WINNER			

Decision of Superiority

Judge 1	Judge 2	Judge 3	Judge 4	Judge 5	Judge 6	Judge 7	Referee

Name _____

Signature _____

Lion Cup 2024 Luxembourg

297 Rue de Reckenthal L-2410 Strassen, LUXEMBOURG

Court Nr.	1	Pool	1	Date	2024-06-08	Field Position	60
RED				BLUE			
NOC	BLUMINK LEVY (NED)			NOC	CUCCINIELLO ENZO (BEL)		
Category	Kumite Male U16 -70kg						
3 Points	2 Points	1 Point	Score	1 Point	2 Points	3 Points	
			3 : 2				
Penatlity				Penatlity			
C1: C3, C2:			3:2	C1: C3, C2:			
WINNER			Total				

Decision of Superiority

Judge 1	Judge 2	Judge 3	Judge 4	Judge 5	Judge 6	Judge 7	Referee

Name _____

Signature _____

Lion Cup 2024 Luxembourg

297 Rue de Reckenthal L-2410 Strassen, LUXEMBOURG

Court Nr.	1	Pool	1	Date	2024-06-08	Field Position	61
RED				BLUE			
NOC	VAN KRUINING FLYNN (NED)			NOC	NEDIOGLO DIMITRII (LUX)		
Category	Kumite Male U16 -70kg						
3 Points	2 Points	1 Point	Score	1 Point	2 Points	3 Points	
			2 : 0				
Penatlity				Penatlity			
C1: C1, C2:				2:0	C1: C2, C2:		
WINNER				Total			

Decision of Superiority

Judge 1	Judge 2	Judge 3	Judge 4	Judge 5	Judge 6	Judge 7	Referee

Name _____

Signature _____

Lion Cup 2024 Luxembourg

297 Rue de Reckenthal L-2410 Strassen, LUXEMBOURG

Court Nr.	1	Pool	1	Date	2024-06-08	Field Position	62	
RED				BLUE				
NOC	PIERANTONI MATTEO (LUX)			NOC	BLUMINK LEVY (NED)			
Category	Kumite Male U16 -70kg							
3 Points	2 Points	1 Point	Score	1 Point	2 Points	3 Points		
			2 : 1					
Penatlity				Penatlity				
C1: HC, C2:				2:1	C1: C2, C2:			
WINNER				Total				

Decision of Superiority

Judge 1	Judge 2	Judge 3	Judge 4	Judge 5	Judge 6	Judge 7	Referee

Name _____

Signature _____

Lion Cup 2024 Luxembourg

297 Rue de Reckenthal L-2410 Strassen, LUXEMBOURG

Court Nr.	1	Pool	1	Date	2024-06-08	Field Position	63
RED				BLUE			
NOC	VAN KRUINING FLYNN (NED)			NOC	PIERANTONI MATTEO (LUX)		
Category	Kumite Male U16 -70kg						
3 Points	2 Points	1 Point	Score	1 Point	2 Points	3 Points	
			3 : 0				
Penatlity				Penatlity			
C1: HC, C2:				3:0	C1: C2, C2:		
WINNER				Total			

Decision of Superiority

Judge 1	Judge 2	Judge 3	Judge 4	Judge 5	Judge 6	Judge 7	Referee

Name _____

Signature _____

Lion Cup 2024 Luxembourg

297 Rue de Reckenthal L-2410 Strassen, LUXEMBOURG

Court Nr.	1	Pool	1	Date	2024-06-08	Field Position	0	
RED				BLUE				
NOC	SAUTELET ARTHUR (BEL)			NOC	NEDIOGLO DIMITRII (LUX)			
Category	Kumite Male U16 -70kg							
3 Points	2 Points	1 Point	Score	1 Point	2 Points	3 Points		
			2 : 6					
Penatlity				Penatlity				
C1: C1, C2:				2:6	C1: C2, C2:			
				Total	WINNER			

Decision of Superiority

Judge 1	Judge 2	Judge 3	Judge 4	Judge 5	Judge 6	Judge 7	Referee

Name _____

Signature _____

Lion Cup 2024 Luxembourg

297 Rue de Reckenthal L-2410 Strassen, LUXEMBOURG

Court Nr.	1	Pool	1	Date	2024-06-08	Field Position	2
RED				BLUE			
NOC	DE WILDE SENNE (BEL)			NOC	SAUTELET ARTHUR (BEL)		
Category	Kumite Male U16 -70kg						
3 Points	2 Points	1 Point	Score	1 Point	2 Points	3 Points	
			:				
Penatlity				Penatlity			
			Total				

Decision of Superiority

Judge 1	Judge 2	Judge 3	Judge 4	Judge 5	Judge 6	Judge 7	Referee

Name _____

Signature _____

Lion Cup 2024 Luxembourg

297 Rue de Reckenthal L-2410 Strassen, LUXEMBOURG

Court Nr.	2	Pool	2	Date	2024-06-08	Field Position	0	
RED				BLUE				
NOC	EL-AIDI YAHYA (BEL)			NOC	BLUMINK LEVY (NED)			
Category	Kumite Male U16 -70kg							
3 Points	2 Points	1 Point	Score	1 Point	2 Points	3 Points		
			2 : 4					
Penatlity				Penatlity				
C1: HC, C2:				2:4	C1: H, C2:			
				Total	WINNER			

Decision of Superiority

Judge 1	Judge 2	Judge 3	Judge 4	Judge 5	Judge 6	Judge 7	Referee

Name _____

Signature _____

Official Results

Kumite Male U16 -70kg			
1	VAN KRUINING FLYNN		NED - NETHERLANDS
2	PIERANTONI MATTEO		LUX - LUXEMBOURG
3	NEDIOGLO DIMITRII		LUX - LUXEMBOURG
3	BLUMINK LEVY		NED - NETHERLANDS
5	SAUTELET ARTHUR		BEL - BELGIUM
5	EL-AIDI YAHYA		BEL - BELGIUM
7	DE WILDE SENNE		BEL - BELGIUM

KUMITE MALE U18 +76KG

Lion Cup 2024 Luxembourg

ENTRIES BY WEIGHT CATEGORY
Kumite Male U18 +76kg

As of 8 JUN 2024

NOC Code	Gender	Name	Seeding
AUT	M	Mayr Werner	
BEL	M	Anisimov vladislav	
LUX	M	Davies Alexander	
NED	M	Kamel Basem	
NED	M	van der Vliet Merijn	
NED	M	van Woudenberg Mika	
SUI	M	Bandelier Mathis	

Kumite Male U18 +76kg

Lion Cup 2024 Luxembourg, 297 Rue de Reckenthal L-2410 Strassen, LUX

2024-06-08

Tatami
2 11:10

Pool
1 / 1

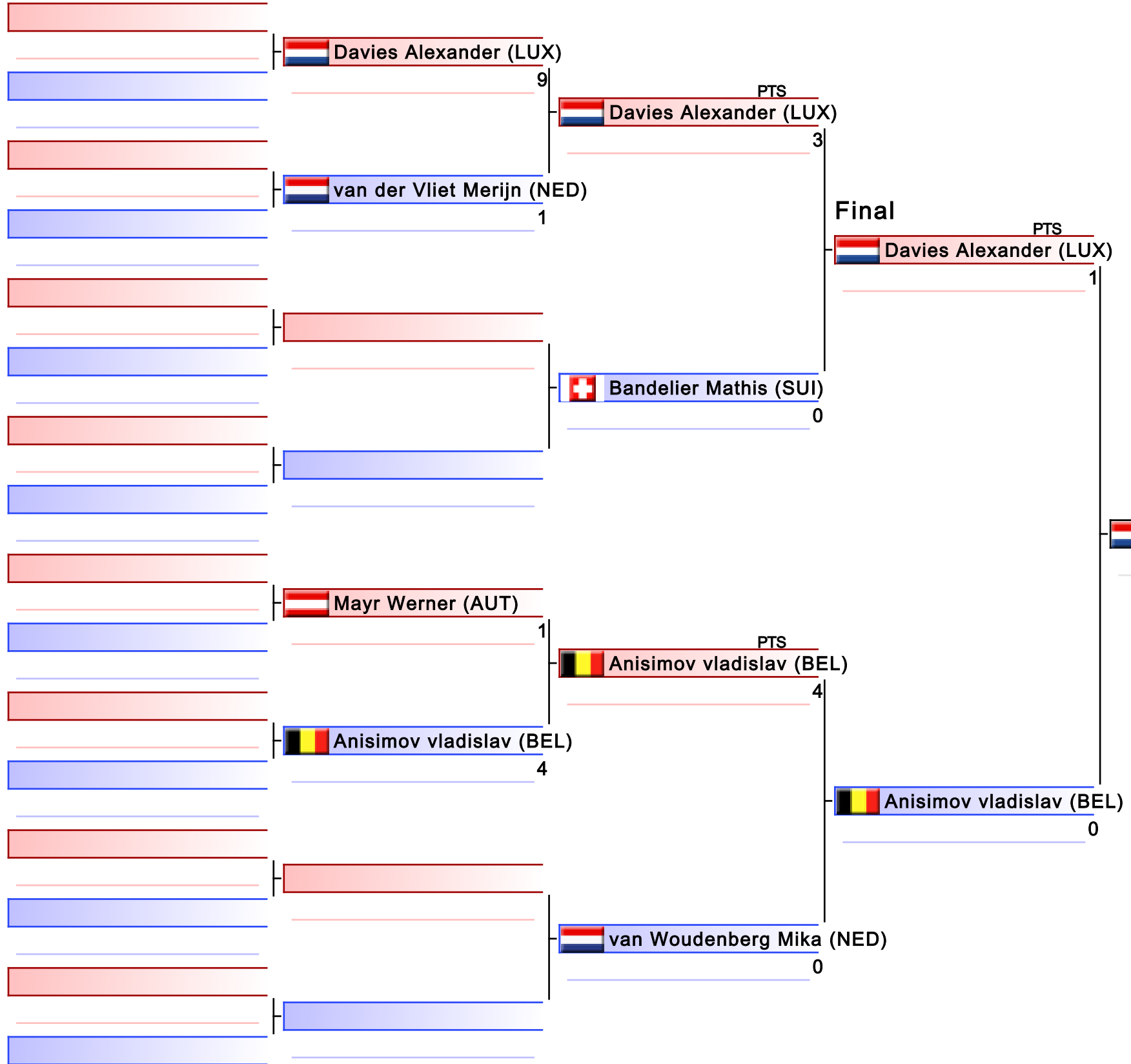

1. DAVIES ALEXANDER (LUX)
2. ANISIMOV VLADISLAV (BEL)
3. VAN DER VLIET MERIJN (NED)
3. VAN WOUDENBERG MIKA (NED)
5. BANDELIER MATHIS (SUI)
5. MAYR WERNER (AUT)

Kumite Male U18 +76kg

Lion Cup 2024 Luxembourg

2024-06-08

Tatami
2 11:25

Pool
1

(c)sportdata GmbH & Co KG 2000-2024 (2024-06-08 18:41) v 10.1.0 build 1 (2024-01-24 23:23 CET) License: Online_Event_ID-7672_LionCup2024Luxembourg (expire 2024-06-21)

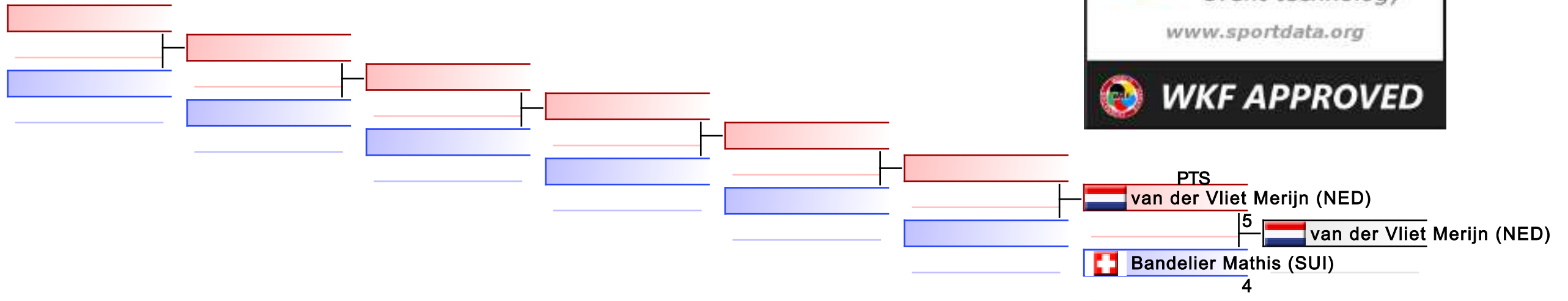

REPECHAGE: (1)

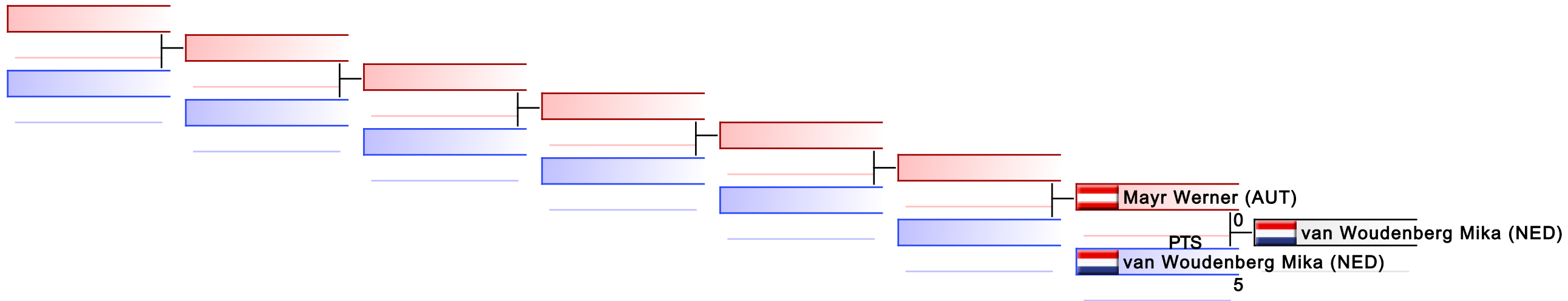

Lion Cup 2024 Luxembourg

297 Rue de Reckenthal L-2410 Strassen, LUXEMBOURG

Court Nr.	1	Pool	1	Date	2024-06-08	Field Position	57
RED				BLUE			
NOC	DAVIES ALEXANDER (LUX)			NOC	VAN DER VLIET MERIJN (NED)		
Category	Kumite Male U18 +76kg						
3 Points	2 Points	1 Point	Score	1 Point	2 Points	3 Points	
			9 : 1				
Penatlity				Penatlity			
C1: C1, C2:				9:1	C1: , C2:		
WINNER				Total			

Decision of Superiority

Judge 1	Judge 2	Judge 3	Judge 4	Judge 5	Judge 6	Judge 7	Referee

Name _____

Signature _____

Lion Cup 2024 Luxembourg

297 Rue de Reckenthal L-2410 Strassen, LUXEMBOURG

Court Nr.	1	Pool	1	Date	2024-06-08	Field Position	59	
RED				BLUE				
NOC	MAYR WERNER (AUT)			NOC	ANISIMOV VLADISLAV (BEL)			
Category	Kumite Male U18 +76kg							
3 Points	2 Points	1 Point	Score	1 Point	2 Points	3 Points		
			1 : 4					
Penatlity				Penatlity				
C1: C1, C2:				1:4	C1: C1, C2:			
				Total	WINNER			

Decision of Superiority

Judge 1	Judge 2	Judge 3	Judge 4	Judge 5	Judge 6	Judge 7	Referee

Name _____

Signature _____

Lion Cup 2024 Luxembourg

297 Rue de Reckenthal L-2410 Strassen, LUXEMBOURG

Court Nr.	1	Pool	1	Date	2024-06-08	Field Position	61
RED				BLUE			
NOC	DAVIES ALEXANDER (LUX)			NOC	BANDELIER MATHIS (SUI)		
Category	Kumite Male U18 +76kg						
3 Points	2 Points	1 Point	Score	1 Point	2 Points	3 Points	
			3 : 0				
Penatlity				Penatlity			
C1: , C2:			3:0	C1: C2, C2:			
WINNER			Total				

PTS

Decision of Superiority

Judge 1	Judge 2	Judge 3	Judge 4	Judge 5	Judge 6	Judge 7	Referee

Name _____

Signature _____

Lion Cup 2024 Luxembourg

297 Rue de Reckenthal L-2410 Strassen, LUXEMBOURG

Court Nr.	1	Pool	1	Date	2024-06-08	Field Position	62
RED				BLUE			
NOC	ANISIMOV VLADISLAV (BEL)			NOC	VAN WOUDENBERG MIKA (NED)		
Category	Kumite Male U18 +76kg						
3 Points	2 Points	1 Point	Score	1 Point	2 Points	3 Points	
			4 : 0				
Penatlity				Penatlity			
C1: C2, C2:				4:0	C1: C1, C2:		
WINNER				Total			

PTS

Decision of Superiority

Judge 1	Judge 2	Judge 3	Judge 4	Judge 5	Judge 6	Judge 7	Referee

Name _____

Signature _____

Lion Cup 2024 Luxembourg

297 Rue de Reckenthal L-2410 Strassen, LUXEMBOURG

Court Nr.	1	Pool	1	Date	2024-06-08	Field Position	63	
RED				BLUE				
NOC	DAVIES ALEXANDER (LUX)			NOC	ANISIMOV VLADISLAV (BEL)			
Category	Kumite Male U18 +76kg							
3 Points	2 Points	1 Point	Score	1 Point	2 Points	3 Points		
			1 : 0					
Penatlity				Penatlity				
C1: C1, C2:				1:0	C1: C1, C2:			
WINNER				Total				

PTS

Decision of Superiority

Judge 1	Judge 2	Judge 3	Judge 4	Judge 5	Judge 6	Judge 7	Referee

Name _____

Signature _____

Lion Cup 2024 Luxembourg

297 Rue de Reckenthal L-2410 Strassen, LUXEMBOURG

Court Nr.	1	Pool	1	Date	2024-06-08	Field Position	0
RED				BLUE			
NOC	VAN DER VLIET MERIJN (NED)			NOC	BANDELIER MATHIS (SUI)		
Category	Kumite Male U18 +76kg						
3 Points	2 Points	1 Point	Score	1 Point	2 Points	3 Points	
			:				
Penatlity				Penatlity			
			Total				

Decision of Superiority

Judge 1	Judge 2	Judge 3	Judge 4	Judge 5	Judge 6	Judge 7	Referee

Name _____

Signature _____

Lion Cup 2024 Luxembourg

297 Rue de Reckenthal L-2410 Strassen, LUXEMBOURG

Court Nr.	2	Pool	2	Date	2024-06-08	Field Position	0
RED				BLUE			
NOC	MAYR WERNER (AUT)			NOC	VAN WOUDENBERG MIKA (NED)		
Category	Kumite Male U18 +76kg						
3 Points	2 Points	1 Point	Score	1 Point	2 Points	3 Points	
			0 : 5				
Penatlity				Penatlity			
C1: , C2:				0:5	C1: C3, C2:		
				Total	WINNER		

PTS

Decision of Superiority

Judge 1	Judge 2	Judge 3	Judge 4	Judge 5	Judge 6	Judge 7	Referee

Name _____

Signature _____

Official Results

Kumite Male U18 +76kg			
1	DAVIES ALEXANDER		LUX - LUXEMBOURG
2	ANISIMOV VLADISLAV		BEL - BELGIUM
3	VAN DER VLIET MERIJN		NED - NETHERLANDS
3	VAN WOUDEBERG MIKA		NED - NETHERLANDS
5	BANDELIER MATHIS		SUI - SWITZERLAND
5	MAYR WERNER		AUT - AUSTRIA

KUMITE MALE U18 -55KG

Lion Cup 2024 Luxembourg

ENTRIES BY WEIGHT CATEGORY
Kumite Male U18 -55kg

As of 8 JUN 2024

NOC Code	Gender	Name	Seeding
ALG	M	TOUIDJINE ABDELILLAH	
ENG	M	Black Joseph	
IRL	M	Kelly Tomas	
LUX	M	Coimbra Pol	
LUX	M	Parasiliti Rantone Mattia	
NED	M	To Nicolas	
SUI	M	Bosch David	
SUI	M	Büttiker Antoine	
SUI	M	Cosse Etienne	

Kumite Male U18 -55kg

Lion Cup 2024 Luxembourg, 297 Rue de Reckenthal L-2410 Strassen, LUX

2024-06-08

Tatami
1 11:05

Pool
1 / 1

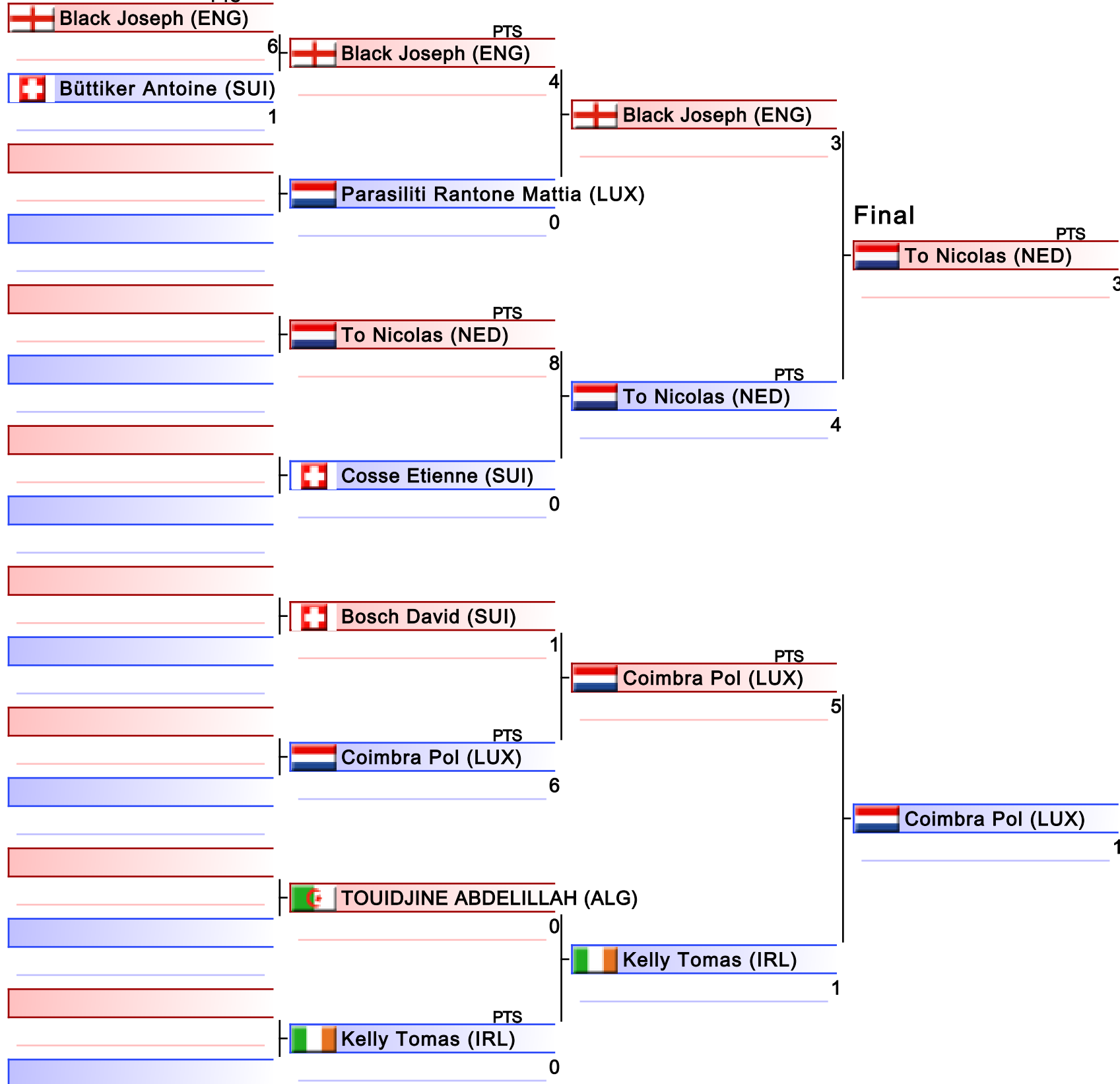

1. TO NICOLAS (NED)
2. COIMBRA POL (LUX)
3. BLACK JOSEPH (ENG)
3. KELLY TOMAS (IRL)
5. COSSE ETIENNE (SUI)
5. BOSCH DAVID (SUI)

Kumite Male U18 -55kg

Lion Cup 2024 Luxembourg

2024-06-08

Tatami
1 11:35

Pool
1

(c)sportdata GmbH & Co KG 2000-2024 (2024-06-08 18:41) v 10.1.0 build 1 (2024-01-24 23:23 CET) License: Online_Event_ID-7672_LionCup2024Luxembourg (expire 2024-06-21)

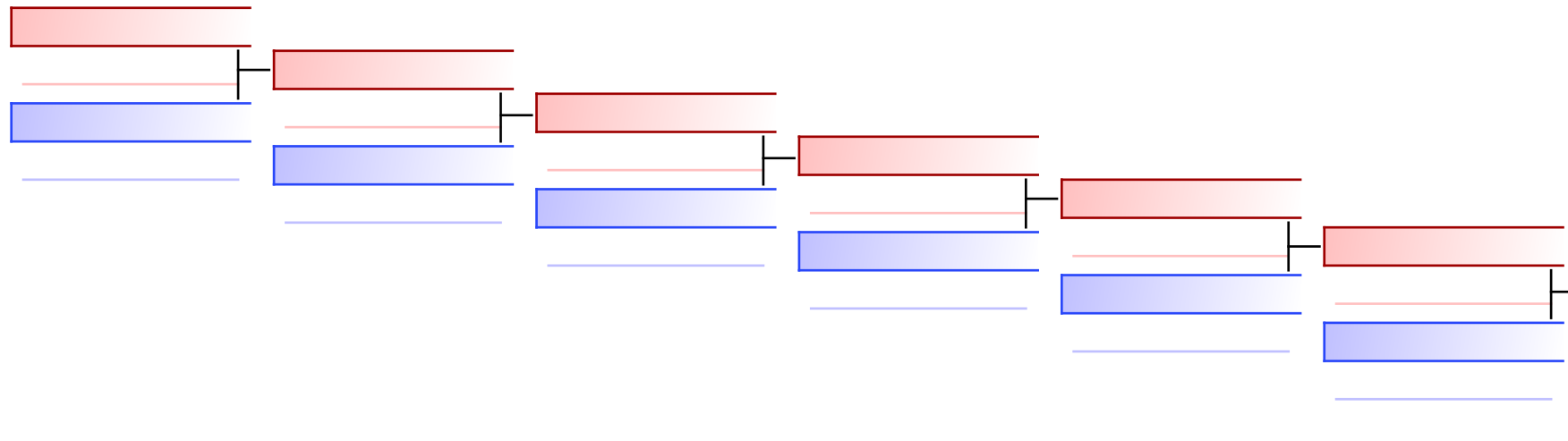

Cosse Etienne (SUI)	0
PTS	
Black Joseph (ENG)	8

REPECHAGE: (1)

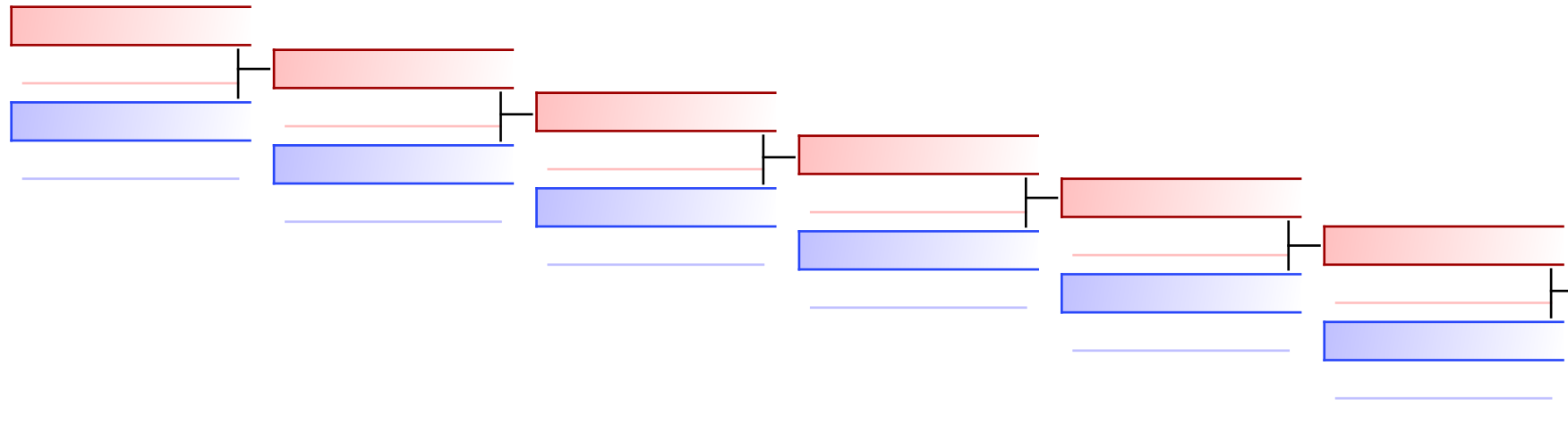

Bosch David (SUI)	0
PTS	
Kelly Tomas (IRL)	1

Lion Cup 2024 Luxembourg

297 Rue de Reckenthal L-2410 Strassen, LUXEMBOURG

Court Nr.	1	Pool	1	Date	2024-06-08	Field Position	49	
RED				BLUE				
NOC	BLACK JOSEPH (ENG)			NOC	BTTIKER ANTOINE (SUI)			
Category	Kumite Male U18 -55kg							
3 Points	2 Points	1 Point	Score	1 Point	2 Points	3 Points		
			6 : 1					
Penatlity				Penatlity				
C1: , C2:				6:1	C1: HC, C2:			
WINNER				Total				

PTS

Decision of Superiority

Judge 1	Judge 2	Judge 3	Judge 4	Judge 5	Judge 6	Judge 7	Referee

Name _____

Signature _____

Lion Cup 2024 Luxembourg

297 Rue de Reckenthal L-2410 Strassen, LUXEMBOURG

Court Nr.	1	Pool	1	Date	2024-06-08	Field Position	57
RED				BLUE			
NOC	BLACK JOSEPH (ENG)			NOC	PARASILITI RANTONE MATTIA (LUX)		
Category	Kumite Male U18 -55kg						
3 Points	2 Points	1 Point	Score	1 Point	2 Points	3 Points	
			4 : 0				
Penatlity				Penatlity			
C1: , C2:				4:0	C1: , C2:		
WINNER				Total			

PTS

Decision of Superiority

Judge 1	Judge 2	Judge 3	Judge 4	Judge 5	Judge 6	Judge 7	Referee

Name _____

Signature _____

Lion Cup 2024 Luxembourg

297 Rue de Reckenthal L-2410 Strassen, LUXEMBOURG

Court Nr.	1	Pool	1	Date	2024-06-08	Field Position	58	
RED				BLUE				
NOC	TO NICOLAS (NED)			NOC	COSSE ETIENNE (SUI)			
Category	Kumite Male U18 -55kg							
3 Points	2 Points	1 Point	Score	1 Point	2 Points	3 Points		
			8 : 0					
Penatlity				Penatlity				
C1: , C2:				8:0	C1: , C2:			
WINNER				Total				

PTS

Decision of Superiority

Judge 1	Judge 2	Judge 3	Judge 4	Judge 5	Judge 6	Judge 7	Referee

Name _____

Signature _____

Lion Cup 2024 Luxembourg

297 Rue de Reckenthal L-2410 Strassen, LUXEMBOURG

Court Nr.	1	Pool	1	Date	2024-06-08	Field Position	59
RED				BLUE			
NOC	BOSCH DAVID (SUI)			NOC	COIMBRA POL (LUX)		
Category	Kumite Male U18 -55kg						
3 Points	2 Points	1 Point	Score	1 Point	2 Points	3 Points	
			1 : 6				
Penatlity				Penatlity			
C1: , C2:				1:6	C1: , C2:		
				Total	WINNER		

PTS

Decision of Superiority

Judge 1	Judge 2	Judge 3	Judge 4	Judge 5	Judge 6	Judge 7	Referee

Name _____

Signature _____

Lion Cup 2024 Luxembourg

297 Rue de Reckenthal L-2410 Strassen, LUXEMBOURG

Court Nr.	1	Pool	1	Date	2024-06-08	Field Position	60
RED				BLUE			
NOC	TOUIDJINE ABDELILLAH (ALG)			NOC	KELLY TOMAS (IRL)		
Category	Kumite Male U18 -55kg						
3 Points	2 Points	1 Point	Score	1 Point	2 Points	3 Points	
			0 : 0				
Penatlity				Penatlity			
C1: , C2:				0:0	C1: , C2:		
				Total	WINNER		

PTS

Decision of Superiority

Judge 1	Judge 2	Judge 3	Judge 4	Judge 5	Judge 6	Judge 7	Referee

Name _____

Signature _____

Lion Cup 2024 Luxembourg

297 Rue de Reckenthal L-2410 Strassen, LUXEMBOURG

Court Nr.	1	Pool	1	Date	2024-06-08	Field Position	61
RED				BLUE			
NOC	BLACK JOSEPH (ENG)			NOC	TO NICOLAS (NED)		
Category	Kumite Male U18 -55kg						
3 Points	2 Points	1 Point	Score	1 Point	2 Points	3 Points	
			3 : 4				
Penatlity				Penatlity			
C1: , C2:			3:4	C1: C1, C2:			
			Total	WINNER			

PTS

Decision of Superiority

Judge 1	Judge 2	Judge 3	Judge 4	Judge 5	Judge 6	Judge 7	Referee

Name _____

Signature _____

Lion Cup 2024 Luxembourg

297 Rue de Reckenthal L-2410 Strassen, LUXEMBOURG

Court Nr.	1	Pool	1	Date	2024-06-08	Field Position	62
RED				BLUE			
NOC	COIMBRA POL (LUX)			NOC	KELLY TOMAS (IRL)		
Category	Kumite Male U18 -55kg						
3 Points	2 Points	1 Point	Score	1 Point	2 Points	3 Points	
			5 : 1				
Penatlity				Penatlity			
C1: , C2:				5:1	C1: , C2:		
WINNER				Total			

PTS

Decision of Superiority

Judge 1	Judge 2	Judge 3	Judge 4	Judge 5	Judge 6	Judge 7	Referee

Name _____

Signature _____

Lion Cup 2024 Luxembourg

297 Rue de Reckenthal L-2410 Strassen, LUXEMBOURG

Court Nr.	1	Pool	1	Date	2024-06-08	Field Position	63	
RED				BLUE				
NOC	TO NICOLAS (NED)			NOC	COIMBRA POL (LUX)			
Category	Kumite Male U18 -55kg							
3 Points	2 Points	1 Point	Score	1 Point	2 Points	3 Points		
			3 : 1					
Penatlity				Penatlity				
C1: C1, C2:				3:1	C1: C1, C2:			
WINNER				Total				

PTS

Decision of Superiority

Judge 1	Judge 2	Judge 3	Judge 4	Judge 5	Judge 6	Judge 7	Referee

Name _____

Signature _____

Lion Cup 2024 Luxembourg

297 Rue de Reckenthal L-2410 Strassen, LUXEMBOURG

Court Nr.	1	Pool	1	Date	2024-06-08	Field Position	0
RED				BLUE			
NOC	COSSE ETIENNE (SUI)			NOC	BLACK JOSEPH (ENG)		
Category	Kumite Male U18 -55kg						
3 Points	2 Points	1 Point	Score	1 Point	2 Points	3 Points	
			:				
Penatlity				Penatlity			
			Total				

Decision of Superiority

Judge 1	Judge 2	Judge 3	Judge 4	Judge 5	Judge 6	Judge 7	Referee

Name _____

Signature _____

Lion Cup 2024 Luxembourg

297 Rue de Reckenthal L-2410 Strassen, LUXEMBOURG

Court Nr.	2	Pool	2	Date	2024-06-08	Field Position	0	
RED				BLUE				
NOC	BOSCH DAVID (SUI)			NOC	KELLY TOMAS (IRL)			
Category	Kumite Male U18 -55kg							
3 Points	2 Points	1 Point	Score	1 Point	2 Points	3 Points		
			0 : 1					
Penatlity				Penatlity				
C1: , C2:				0:1	C1: HC, C2:			
				Total	WINNER			

PTS

Decision of Superiority

Judge 1	Judge 2	Judge 3	Judge 4	Judge 5	Judge 6	Judge 7	Referee

Name _____

Signature _____

Lion Cup 2024 Luxembourg - 2024-06-07

Official Results

Kumite Male U18 -55kg			
1	TO NICOLAS		NED - NETHERLANDS
2	COIMBRA POL		LUX - LUXEMBOURG
3	BLACK JOSEPH		ENG - ENGLAND
3	KELLY TOMAS		IRL - IRELAND
5	COSSE ETIENNE		SUI - SWITZERLAND
5	BOSCH DAVID		SUI - SWITZERLAND

KUMITE MALE U18 -61KG

Lion Cup 2024 Luxembourg

ENTRIES BY WEIGHT CATEGORY
Kumite Male U18 -61kg

As of 8 JUN 2024

NOC Code	Gender	Name	Seeding
AUT	M	WINTERSPERGER Lorenz	
BEL	M	DE BRUYNE STAN	
BEL	M	Kavak Tufan	
BEL	M	ROMBEAUX MATT	
BEL	M	Verhuyght Kenny	
IRL	M	Kelly Cathal	
LUX	M	Lambot Gaspard	
NED	M	Achghouyab Samy	
NED	M	Persaud Matthew	
NED	M	Sardjoe Missier Rohit	
SUI	M	Debost Gaspard	
SUI	M	Kabashi Elson Jason	
SUI	M	Wenger Levin	
SWE	M	Bechtioui Taha	

Kumite Male U18 -61kg

Lion Cup 2024 Luxembourg, 297 Rue de Reckenthal L-2410 Strassen, LUX

2024-06-08

Tatami

5 11:30

Pool

1/1

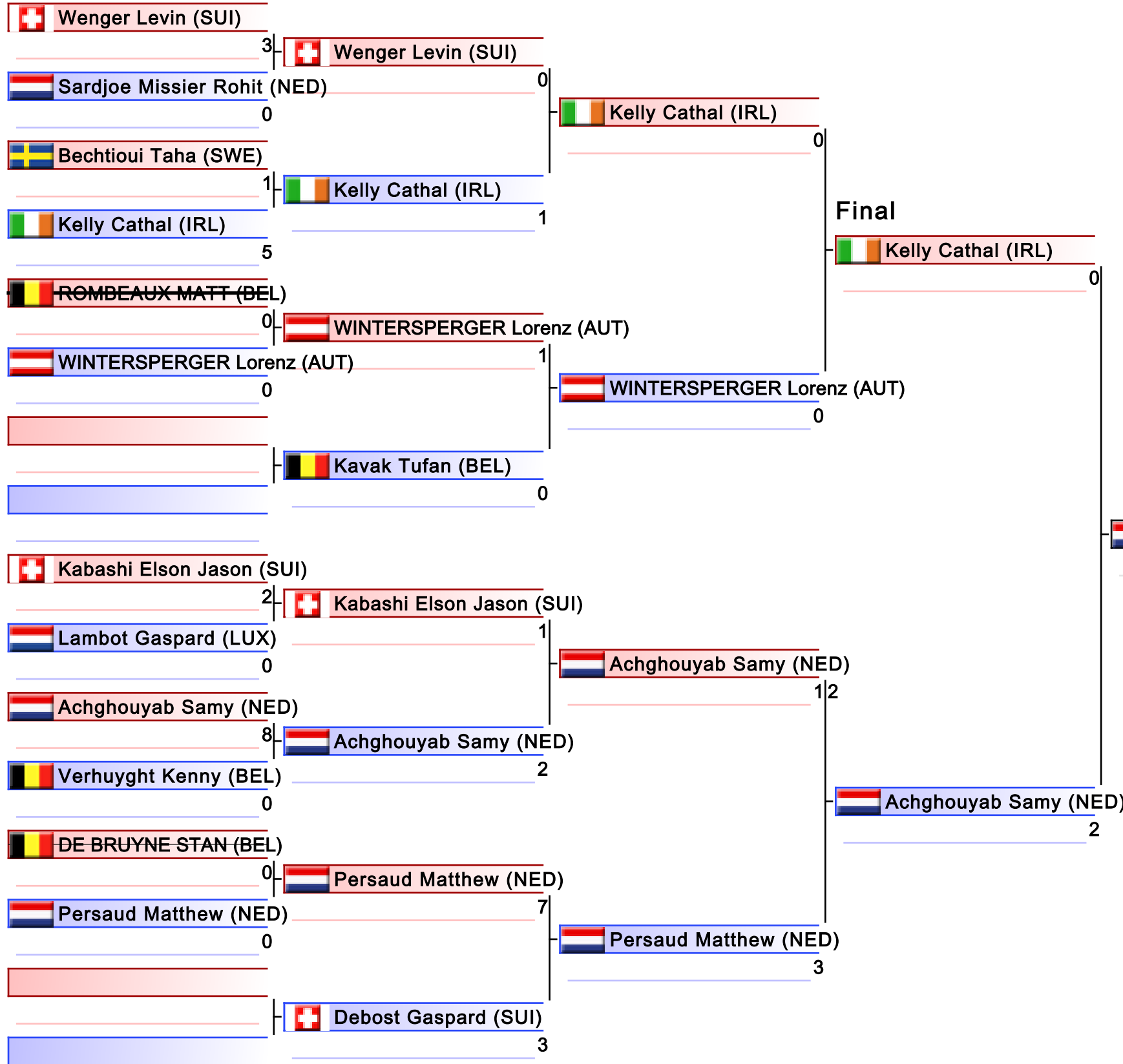

1. ACHGHOUYAB SAMY (NED)
2. KELLY CATHAL (IRL)
3. BECHTIOUI TAHA (SWE)
3. PERSAUD MATTHEW (NED)
5. WINTERSPERGER LORENZ (AUT)
5. KABASHI ELSON JASON (SUI)
7. WENGER LEVIN (SUI)
7. VERHUYGHT KENNY (BEL)

Kumite Male U18 -61kg

Lion Cup 2024 Luxembourg

2024-06-08

Tatami
5 12:20

Pool
1

(c)sportdata GmbH & Co KG 2000-2024 (2024-06-08 18:41) v 10.1.0 build 1 (2024-01-24 23:23 CET) License: Online_Event_ID-7672_LionCup2024Luxembourg (expire 2024-06-21)

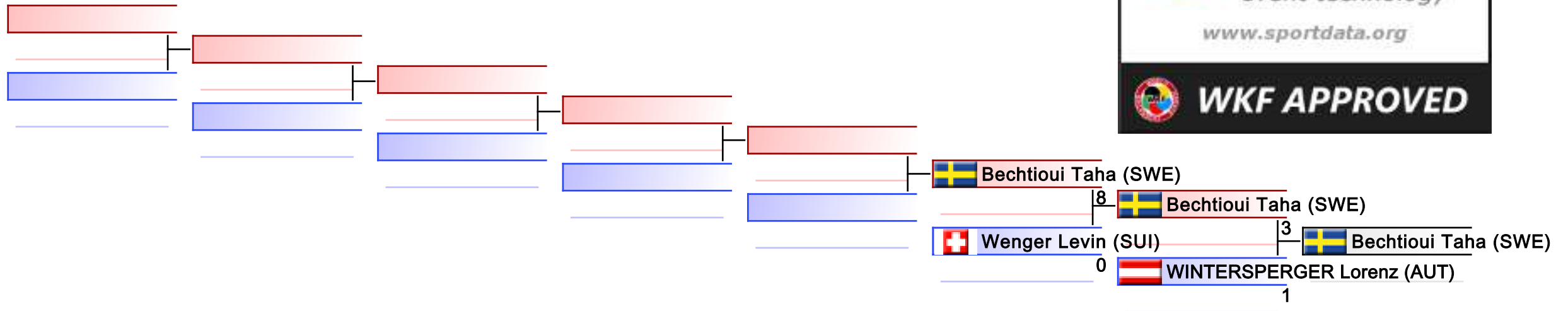

REPECHAGE: (1)

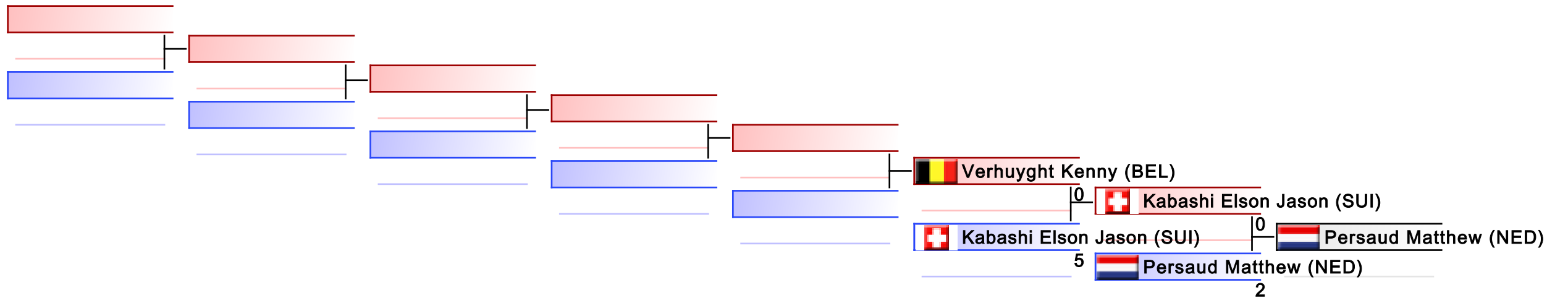

Lion Cup 2024 Luxembourg

297 Rue de Reckenthal L-2410 Strassen, LUXEMBOURG

Court Nr.	1	Pool	1	Date	2024-06-08	Field Position	49
RED				BLUE			
NOC	WENGER LEVIN (SUI)			NOC	SARDJOE MISSIER ROHIT (NED)		
Category	Kumite Male U18 -61kg						
3 Points	2 Points	1 Point	Score	1 Point	2 Points	3 Points	
			3 : 0				
Penatlity					Penatlity		
C1: C1, C2:				3:0	C1: C1, C2:		
WINNER				Total			

Decision of Superiority

Judge 1	Judge 2	Judge 3	Judge 4	Judge 5	Judge 6	Judge 7	Referee

Name _____

Signature _____

Lion Cup 2024 Luxembourg

297 Rue de Reckenthal L-2410 Strassen, LUXEMBOURG

Court Nr.	1	Pool	1	Date	2024-06-08	Field Position	50
RED				BLUE			
NOC	BECHTIOUI TAHA (SWE)			NOC	KELLY CATHAL (IRL)		
Category	Kumite Male U18 -61kg						
3 Points	2 Points	1 Point	Score	1 Point	2 Points	3 Points	
			1 : 5				
Penatlity				Penatlity			
C1: , C2:				1:5	C1: , C2:		
				Total	WINNER		

Decision of Superiority

Judge 1	Judge 2	Judge 3	Judge 4	Judge 5	Judge 6	Judge 7	Referee

Name _____

Signature _____

Lion Cup 2024 Luxembourg

297 Rue de Reckenthal L-2410 Strassen, LUXEMBOURG

Court Nr.	1	Pool	1	Date	2024-06-08	Field Position	53
RED				BLUE			
NOC	KABASHI ELSON JASON (SUI)			NOC	LAMBOT GASPARD (LUX)		
Category	Kumite Male U18 -61kg						
3 Points	2 Points	1 Point	Score	1 Point	2 Points	3 Points	
			2 : 0				
Penatlity					Penatlity		
C1: C1, C2:				2:0	C1: C2, C2:		
WINNER				Total			

Decision of Superiority

Judge 1	Judge 2	Judge 3	Judge 4	Judge 5	Judge 6	Judge 7	Referee

Name _____

Signature _____

Lion Cup 2024 Luxembourg

297 Rue de Reckenthal L-2410 Strassen, LUXEMBOURG

Court Nr.	1	Pool	1	Date	2024-06-08	Field Position	54
RED				BLUE			
NOC	ACHGHOUYAB SAMY (NED)			NOC	VERHUYGHT KENNY (BEL)		
Category	Kumite Male U18 -61kg						
3 Points	2 Points	1 Point	Score	1 Point	2 Points	3 Points	
			8 : 0				
Penatlity				Penatlity			
C1: C2, C2:				8:0	C1: , C2:		
WINNER				Total			

Decision of Superiority

Judge 1	Judge 2	Judge 3	Judge 4	Judge 5	Judge 6	Judge 7	Referee

Name _____

Signature _____

Lion Cup 2024 Luxembourg

297 Rue de Reckenthal L-2410 Strassen, LUXEMBOURG

Court Nr.	1	Pool	1	Date	2024-06-08	Field Position	57
RED				BLUE			
NOC	WENGER LEVIN (SUI)			NOC	KELLY CATHAL (IRL)		
Category	Kumite Male U18 -61kg						
3 Points	2 Points	1 Point	Score	1 Point	2 Points	3 Points	
			0 : 1				
Penatlity					Penatlity		
C1: C1, C2:				0:1	C1: C1, C2:		
				Total	WINNER		

Decision of Superiority

Judge 1	Judge 2	Judge 3	Judge 4	Judge 5	Judge 6	Judge 7	Referee

Name _____

Signature _____

Lion Cup 2024 Luxembourg

297 Rue de Reckenthal L-2410 Strassen, LUXEMBOURG

Court Nr.	1	Pool	1	Date	2024-06-08	Field Position	58
RED				BLUE			
NOC	WINTERSPERGER LORENZ (AUT)			NOC	KAVAK TUFAN (BEL)		
Category	Kumite Male U18 -61kg						
3 Points	2 Points	1 Point	Score	1 Point	2 Points	3 Points	
			1 : 0				
Penatlity				Penatlity			
C1: HC, C2:				1:0	C1: , C2:		
WINNER				Total			

Decision of Superiority

Judge 1	Judge 2	Judge 3	Judge 4	Judge 5	Judge 6	Judge 7	Referee

Name _____

Signature _____

Lion Cup 2024 Luxembourg

297 Rue de Reckenthal L-2410 Strassen, LUXEMBOURG

Court Nr.	1	Pool	1	Date	2024-06-08	Field Position	59	
RED				BLUE				
NOC	KABASHI ELSON JASON (SUI)			NOC	ACHGHOUYAB SAMY (NED)			
Category	Kumite Male U18 -61kg							
3 Points	2 Points	1 Point	Score	1 Point	2 Points	3 Points		
			1 : 2					
Penatlity				Penatlity				
C1: C1, C2:				1:2	C1: HC, C2:			
				Total	WINNER			

Decision of Superiority

Judge 1	Judge 2	Judge 3	Judge 4	Judge 5	Judge 6	Judge 7	Referee

Name _____

Signature _____

Lion Cup 2024 Luxembourg

297 Rue de Reckenthal L-2410 Strassen, LUXEMBOURG

Court Nr.	1	Pool	1	Date	2024-06-08	Field Position	60	
RED				BLUE				
NOC	PERSAUD MATTHEW (NED)			NOC	DEBOST GASPARD (SUI)			
Category	Kumite Male U18 -61kg							
3 Points	2 Points	1 Point	Score	1 Point	2 Points	3 Points		
			7 : 3					
Penatlity				Penatlity				
C1: , C2:				7:3	C1: C1, C2:			
WINNER				Total				

Decision of Superiority

Judge 1	Judge 2	Judge 3	Judge 4	Judge 5	Judge 6	Judge 7	Referee

Name _____

Signature _____

Lion Cup 2024 Luxembourg

297 Rue de Reckenthal L-2410 Strassen, LUXEMBOURG

Court Nr.	1	Pool	1	Date	2024-06-08	Field Position	61
RED				BLUE			
NOC	KELLY CATHAL (IRL)			NOC	WINTERSPERGER LORENZ (AUT)		
Category	Kumite Male U18 -61kg						
3 Points	2 Points	1 Point	Score	1 Point	2 Points	3 Points	
			0 : 0				
Penatlity				Penatlity			
C1: , C2:				0:0	C1: , C2:		
WINNER				Total			

Decision of Superiority

Judge 1	Judge 2	Judge 3	Judge 4	Judge 5	Judge 6	Judge 7	Referee

Name _____

Signature _____

Lion Cup 2024 Luxembourg

297 Rue de Reckenthal L-2410 Strassen, LUXEMBOURG

Court Nr.	1	Pool	1	Date	2024-06-08	Field Position	62	
RED				BLUE				
NOC	ACHGHOUYAB SAMY (NED)			NOC	PERSAUD MATTHEW (NED)			
Category	Kumite Male U18 -61kg							
3 Points	2 Points	1 Point	Score	1 Point	2 Points	3 Points		
			12 : 3					
Penatlity				Penatlity				
			C1: , C2:	12:3				C1: , C2:
			WINNER	Total				

Decision of Superiority

Judge 1	Judge 2	Judge 3	Judge 4	Judge 5	Judge 6	Judge 7	Referee

Name _____

Signature _____

Lion Cup 2024 Luxembourg

297 Rue de Reckenthal L-2410 Strassen, LUXEMBOURG

Court Nr.	1	Pool	1	Date	2024-06-08	Field Position	63
RED				BLUE			
NOC	KELLY CATHAL (IRL)			NOC	ACHGHOUYAB SAMY (NED)		
Category	Kumite Male U18 -61kg						
3 Points	2 Points	1 Point	Score	1 Point	2 Points	3 Points	
			0 : 2				
Penatlity				Penatlity			
C1: C1, C2:			0:2	C1: HC, C2:			
			Total	WINNER			

Decision of Superiority

Judge 1	Judge 2	Judge 3	Judge 4	Judge 5	Judge 6	Judge 7	Referee

Name _____

Signature _____

Lion Cup 2024 Luxembourg

297 Rue de Reckenthal L-2410 Strassen, LUXEMBOURG

Court Nr.	1	Pool	1	Date	2024-06-08	Field Position	0	
RED				BLUE				
NOC	BECHTIOUI TAHA (SWE)			NOC	WINTERSPERGER LORENZ (AUT)			
Category	Kumite Male U18 -61kg							
3 Points	2 Points	1 Point	Score	1 Point	2 Points	3 Points		
			3 : 1					
Penatlity				Penatlity				
C1: C3, C2:				3:1	C1: HC, C2:			
WINNER				Total				

Decision of Superiority

Judge 1	Judge 2	Judge 3	Judge 4	Judge 5	Judge 6	Judge 7	Referee

Name _____

Signature _____

Lion Cup 2024 Luxembourg

297 Rue de Reckenthal L-2410 Strassen, LUXEMBOURG

Court Nr.	1	Pool	1	Date	2024-06-08	Field Position	2
RED				BLUE			
NOC	BECHTIOUI TAHA (SWE)			NOC	WENGER LEVIN (SUI)		
Category	Kumite Male U18 -61kg						
3 Points	2 Points	1 Point	Score	1 Point	2 Points	3 Points	
			:				
Penatlity				Penatlity			
			Total				

Decision of Superiority

Judge 1	Judge 2	Judge 3	Judge 4	Judge 5	Judge 6	Judge 7	Referee

Name _____

Signature _____

Lion Cup 2024 Luxembourg

297 Rue de Reckenthal L-2410 Strassen, LUXEMBOURG

Court Nr.	2	Pool	2	Date	2024-06-08	Field Position	0	
RED				BLUE				
NOC	KABASHI ELSON JASON (SUI)			NOC	PERSAUD MATTHEW (NED)			
Category	Kumite Male U18 -61kg							
3 Points	2 Points	1 Point	Score	1 Point	2 Points	3 Points		
			0 : 2					
Penatlity				Penatlity				
C1: C3, C2:				0:2	C1: , C2:			
				Total	WINNER			

Decision of Superiority

Judge 1	Judge 2	Judge 3	Judge 4	Judge 5	Judge 6	Judge 7	Referee

Name _____

Signature _____

Lion Cup 2024 Luxembourg

297 Rue de Reckenthal L-2410 Strassen, LUXEMBOURG

Court Nr.	2	Pool	2	Date	2024-06-08	Field Position	2	
RED				BLUE				
NOC	VERHUYGHT KENNY (BEL)			NOC	KABASHI ELSON JASON (SUI)			
Category	Kumite Male U18 -61kg							
3 Points	2 Points	1 Point	Score	1 Point	2 Points	3 Points		
			0 : 5					
Penatlity				Penatlity				
C1: C1, C2:				0:5	C1: HC, C2:			
				Total	WINNER			

Decision of Superiority

Judge 1	Judge 2	Judge 3	Judge 4	Judge 5	Judge 6	Judge 7	Referee

Name _____

Signature _____

Lion Cup 2024 Luxembourg - 2024-06-07

Official Results

Kumite Male U18 -61kg			
1	ACHGHOUYAB SAMY		NED - NETHERLANDS
2	KELLY CATHAL		IRL - IRELAND
3	BECHTIOUI TAHA		SWE - SWEDEN
3	PERSAUD MATTHEW		NED - NETHERLANDS
5	WINTERSPERGER LORENZ		AUT - AUSTRIA
5	KABASHI ELSON JASON		SUI - SWITZERLAND
7	WENGER LEVIN		SUI - SWITZERLAND
7	VERHUYGHT KENNY		BEL - BELGIUM

KUMITE MALE U18 -68KG

Lion Cup 2024 Luxembourg

ENTRIES BY WEIGHT CATEGORY
Kumite Male U18 -68kg

As of 8 JUN 2024

NOC Code	Gender	Name	Seeding
ALG	M	SAHRAOUI MOHAMMED AMINE	
AUT	M	Fortner Niklas	
BEL	M	Tamburrini Dorian	
FRA	M	stagni reia	
LUX	M	Knarov Maxence	
NED	M	Buduri Alban	
NED	M	Kouwenhoven Daan	
NED	M	Krijnen Thomas	
NED	M	Werff Kai	
POR	M	Alves Lucas	
POR	M	Ribeiro Diogo	
SUI	M	Daboubi Yassine	
SUI	M	KARLEN Théo	
SUI	M	Leuenberger Maximilian	
SUI	M	Lorenz Swan	
SUI	M	Ott Simon	
SUI	M	Oymak Yusuf	
SUI	M	Torres Steven	
SUI	M	Tscharner Loan	

Kumite Male U18 -68kg

Lion Cup 2024 Luxembourg, 297 Rue de Reckenthal L-2410 Strassen, LUX

2024-06-08

Tatami
6 11:30

Pool
1 / 1

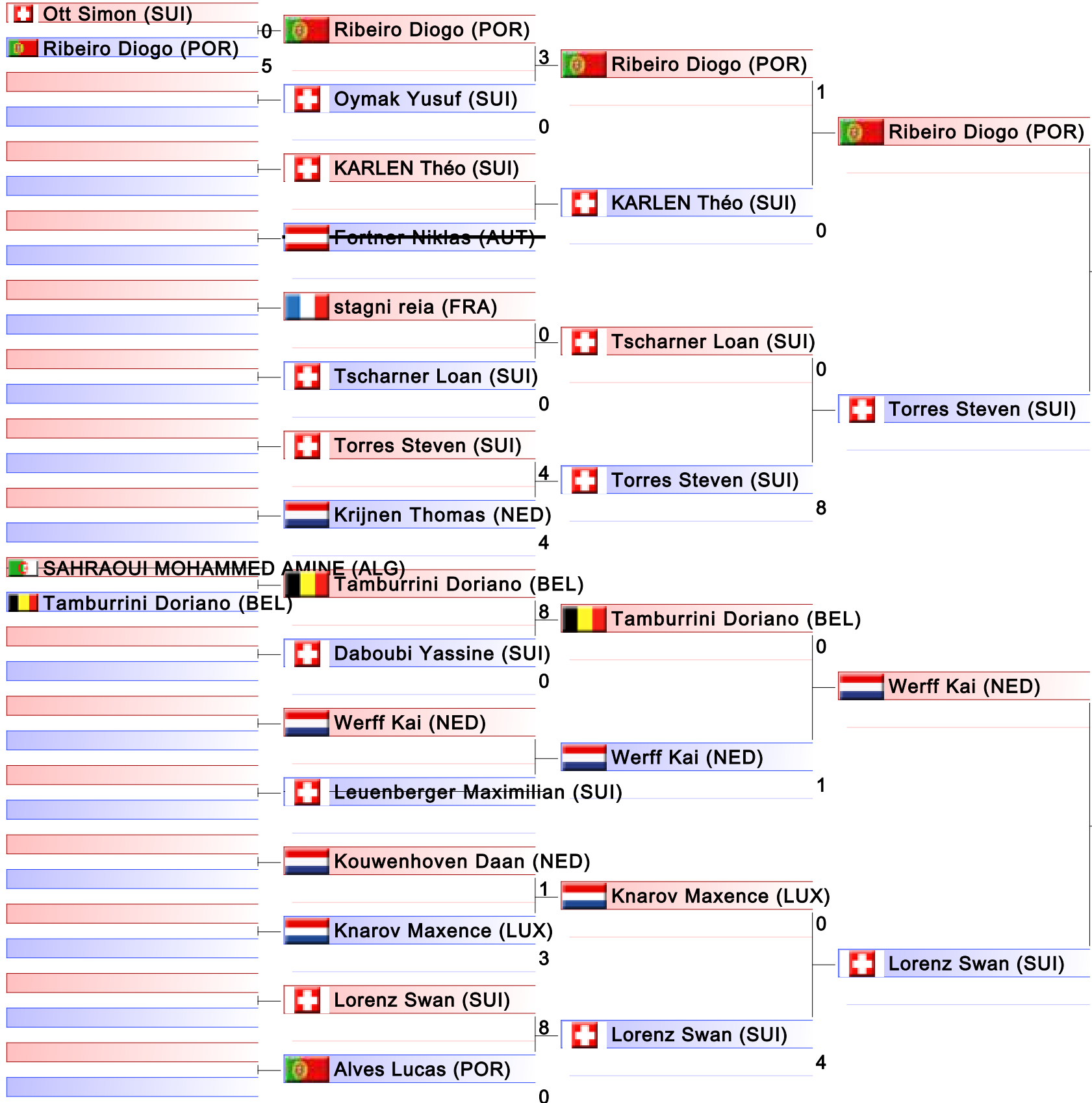

Final

1. TORRES STEVEN (SUI)
2. LORENZ SWAN (SUI)
3. KRIJNEN THOMAS (NED)
3. WERFF KAI (NED)
5. RIBEIRO DIOGO (POR)
5. ALVES LUCAS (POR)
7. TSCHARNER LOAN (SUI)
7. KNAROV MAXENCE (LUX)

Kumite Male U18 -68kg

Lion Cup 2024 Luxembourg

2024-06-08 6 12:35
Tatami 1
Pool 1

(c)sportdata GmbH & Co KG 2000-2024 (2024-06-08 18:41) v 10.1.0 build 1 (2024-01-24 23:23 CET) License: Online_Event_ID-7672_LionCup2024Luxembourg (expire 2024-06-21)

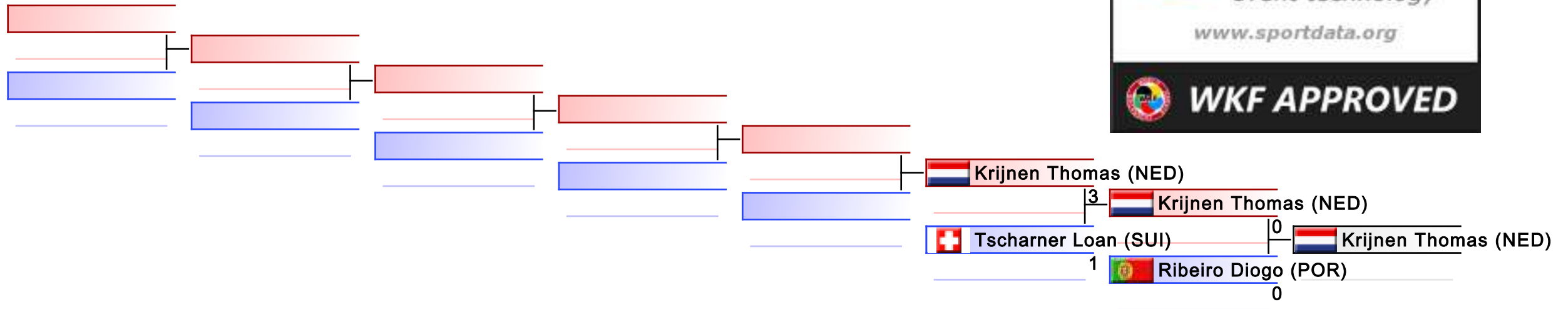

REPECHAGE: (1)

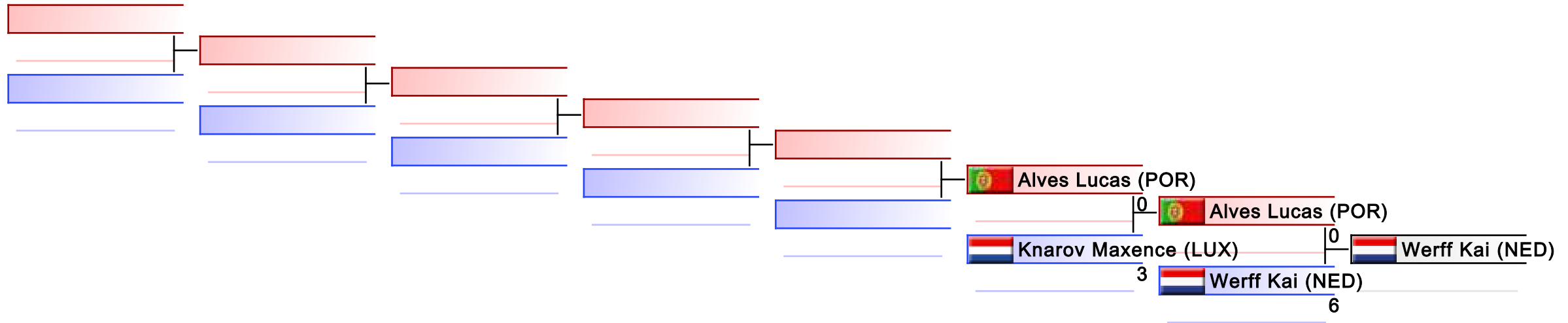

Lion Cup 2024 Luxembourg

297 Rue de Reckenthal L-2410 Strassen, LUXEMBOURG

Court Nr.	1	Pool	1	Date	2024-06-08	Field Position	33
RED				BLUE			
NOC	OTT SIMON (SUI)			NOC	RIBEIRO DIOGO (POR)		
Category	Kumite Male U18 -68kg						
3 Points	2 Points	1 Point	Score	1 Point	2 Points	3 Points	
			0 : 5				
Penatlity				Penatlity			
C1: , C2:			0:5	C1: , C2:			
			Total	WINNER			

Decision of Superiority

Judge 1	Judge 2	Judge 3	Judge 4	Judge 5	Judge 6	Judge 7	Referee

Name _____

Signature _____

Lion Cup 2024 Luxembourg

297 Rue de Reckenthal L-2410 Strassen, LUXEMBOURG

Court Nr.	1	Pool	1	Date	2024-06-08	Field Position	49
RED				BLUE			
NOC	RIBEIRO DIOGO (POR)			NOC	OYMAK YUSUF (SUI)		
Category	Kumite Male U18 -68kg						
3 Points	2 Points	1 Point	Score	1 Point	2 Points	3 Points	
			3 : 0				
Penatlity				Penatlity			
C1: , C2:				3:0	C1: , C2:		
WINNER				Total			

Decision of Superiority

Judge 1	Judge 2	Judge 3	Judge 4	Judge 5	Judge 6	Judge 7	Referee

Name _____

Signature _____

Lion Cup 2024 Luxembourg

297 Rue de Reckenthal L-2410 Strassen, LUXEMBOURG

Court Nr.	1	Pool	1	Date	2024-06-08	Field Position	51
RED				BLUE			
NOC	STAGNI REIA (FRA)			NOC	TSCHARNER LOAN (SUI)		
Category	Kumite Male U18 -68kg						
3 Points	2 Points	1 Point	Score	1 Point	2 Points	3 Points	
			0 : 0				
Penatlity				Penatlity			
C1: , C2:				0:0	C1: , C2:		
				Total	WINNER		

Decision of Superiority

Judge 1	Judge 2	Judge 3	Judge 4	Judge 5	Judge 6	Judge 7	Referee

Name _____

Signature _____

Lion Cup 2024 Luxembourg

297 Rue de Reckenthal L-2410 Strassen, LUXEMBOURG

Court Nr.	1	Pool	1	Date	2024-06-08	Field Position	52
RED				BLUE			
NOC	TORRES STEVEN (SUI)			NOC	KRIJNEN THOMAS (NED)		
Category	Kumite Male U18 -68kg						
3 Points	2 Points	1 Point	Score	1 Point	2 Points	3 Points	
			4 : 4				
Penatlity				Penatlity			
C1: C2, C2:				4:4	C1: HC, C2:		
WINNER				Total			

Decision of Superiority

Judge 1	Judge 2	Judge 3	Judge 4	Judge 5	Judge 6	Judge 7	Referee

Name _____

Signature _____

Lion Cup 2024 Luxembourg

297 Rue de Reckenthal L-2410 Strassen, LUXEMBOURG

Court Nr.	1	Pool	1	Date	2024-06-08	Field Position	53	
RED				BLUE				
NOC	TAMBURRINI DORIANO (BEL)			NOC	DABOUBI YASSINE (SUI)			
Category	Kumite Male U18 -68kg							
3 Points	2 Points	1 Point	Score	1 Point	2 Points	3 Points		
			8 : 0					
Penatlity				Penatlity				
C1: C1, C2:				8:0	C1: C1, C2:			
WINNER				Total				

Decision of Superiority

Judge 1	Judge 2	Judge 3	Judge 4	Judge 5	Judge 6	Judge 7	Referee

Name _____

Signature _____

Lion Cup 2024 Luxembourg

297 Rue de Reckenthal L-2410 Strassen, LUXEMBOURG

Court Nr.	1	Pool	1	Date	2024-06-08	Field Position	55	
RED				BLUE				
NOC	KOUWENHOVEN DAAN (NED)			NOC	KNAROV MAXENCE (LUX)			
Category	Kumite Male U18 -68kg							
3 Points	2 Points	1 Point	Score	1 Point	2 Points	3 Points		
			1 : 3					
Penatlity				Penatlity				
C1: C3, C2:				1:3	C1: HC, C2:			
				Total	WINNER			

Decision of Superiority

Judge 1	Judge 2	Judge 3	Judge 4	Judge 5	Judge 6	Judge 7	Referee

Name _____

Signature _____

Lion Cup 2024 Luxembourg

297 Rue de Reckenthal L-2410 Strassen, LUXEMBOURG

Court Nr.	1	Pool	1	Date	2024-06-08	Field Position	56	
RED				BLUE				
NOC	LORENZ SWAN (SUI)			NOC	ALVES LUCAS (POR)			
Category	Kumite Male U18 -68kg							
3 Points	2 Points	1 Point	Score	1 Point	2 Points	3 Points		
			8 : 0					
Penatlity				Penatlity				
C1: C2, C2:				8:0	C1: C1, C2:			
WINNER				Total				

Decision of Superiority

Judge 1	Judge 2	Judge 3	Judge 4	Judge 5	Judge 6	Judge 7	Referee

Name _____

Signature _____

Lion Cup 2024 Luxembourg

297 Rue de Reckenthal L-2410 Strassen, LUXEMBOURG

Court Nr.	1	Pool	1	Date	2024-06-08	Field Position	57
RED				BLUE			
NOC	RIBEIRO DIOGO (POR)			NOC	KARLEN THO (SUI)		
Category	Kumite Male U18 -68kg						
3 Points	2 Points	1 Point	Score	1 Point	2 Points	3 Points	
			1 : 0				
Penatlity				Penatlity			
C1: C3, C2:			1:0	C1: HC, C2:			
WINNER			Total				

Decision of Superiority

Judge 1	Judge 2	Judge 3	Judge 4	Judge 5	Judge 6	Judge 7	Referee

Name _____

Signature _____

Lion Cup 2024 Luxembourg

297 Rue de Reckenthal L-2410 Strassen, LUXEMBOURG

Court Nr.	1	Pool	1	Date	2024-06-08	Field Position	58	
RED				BLUE				
NOC	TSCHARNER LOAN (SUI)			NOC	TORRES STEVEN (SUI)			
Category	Kumite Male U18 -68kg							
3 Points	2 Points	1 Point	Score	1 Point	2 Points	3 Points		
			0 : 8					
Penatlity				Penatlity				
C1: , C2:				0:8	C1: C1, C2:			
				Total	WINNER			

Decision of Superiority

Judge 1	Judge 2	Judge 3	Judge 4	Judge 5	Judge 6	Judge 7	Referee

Name _____

Signature _____

Lion Cup 2024 Luxembourg

297 Rue de Reckenthal L-2410 Strassen, LUXEMBOURG

Court Nr.	1	Pool	1	Date	2024-06-08	Field Position	59
RED				BLUE			
NOC	TAMBURRINI DORIANO (BEL)			NOC	WERFF KAI (NED)		
Category	Kumite Male U18 -68kg						
3 Points	2 Points	1 Point	Score	1 Point	2 Points	3 Points	
			0 : 1				
Penatlity				Penatlity			
C1: C2, C2:				0:1	C1: , C2:		
				Total	WINNER		

Decision of Superiority

Judge 1	Judge 2	Judge 3	Judge 4	Judge 5	Judge 6	Judge 7	Referee

Name _____

Signature _____

Lion Cup 2024 Luxembourg

297 Rue de Reckenthal L-2410 Strassen, LUXEMBOURG

Court Nr.	1	Pool	1	Date	2024-06-08	Field Position	60
RED				BLUE			
NOC	KNAROV MAXENCE (LUX)			NOC	LORENZ SWAN (SUI)		
Category	Kumite Male U18 -68kg						
3 Points	2 Points	1 Point	Score	1 Point	2 Points	3 Points	
			0 : 4				
Penatlity				Penatlity			
C1: , C2:			0:4	C1: , C2:			
			Total	WINNER			

Decision of Superiority

Judge 1	Judge 2	Judge 3	Judge 4	Judge 5	Judge 6	Judge 7	Referee

Name _____

Signature _____

Lion Cup 2024 Luxembourg

297 Rue de Reckenthal L-2410 Strassen, LUXEMBOURG

Court Nr.	1	Pool	1	Date	2024-06-08	Field Position	61
RED				BLUE			
NOC	RIBEIRO DIOGO (POR)			NOC	TORRES STEVEN (SUI)		
Category	Kumite Male U18 -68kg						
3 Points	2 Points	1 Point	Score	1 Point	2 Points	3 Points	
			1 : 2				
Penatlity				Penatlity			
C1: , C2:			1:2	C1: C2, C2:			
			Total	WINNER			

Decision of Superiority

Judge 1	Judge 2	Judge 3	Judge 4	Judge 5	Judge 6	Judge 7	Referee

Name _____

Signature _____

Lion Cup 2024 Luxembourg

297 Rue de Reckenthal L-2410 Strassen, LUXEMBOURG

Court Nr.	1	Pool	1	Date	2024-06-08	Field Position	62	
RED				BLUE				
NOC	WERFF KAI (NED)			NOC	LORENZ SWAN (SUI)			
Category	Kumite Male U18 -68kg							
3 Points	2 Points	1 Point	Score	1 Point	2 Points	3 Points		
			0 : 1					
Penatlity				Penatlity				
C1: C1, C2:				0:1	C1: HC, C2:			
				Total	WINNER			

Decision of Superiority

Judge 1	Judge 2	Judge 3	Judge 4	Judge 5	Judge 6	Judge 7	Referee

Name _____

Signature _____

Lion Cup 2024 Luxembourg

297 Rue de Reckenthal L-2410 Strassen, LUXEMBOURG

Court Nr.	1	Pool	1	Date	2024-06-08	Field Position	63	
RED				BLUE				
NOC	TORRES STEVEN (SUI)			NOC	LORENZ SWAN (SUI)			
Category	Kumite Male U18 -68kg							
3 Points	2 Points	1 Point	Score	1 Point	2 Points	3 Points		
			1 : 0					
Penatlity				Penatlity				
C1: C2, C2:				1:0	C1: HC, C2:			
WINNER				Total				

Decision of Superiority

Judge 1	Judge 2	Judge 3	Judge 4	Judge 5	Judge 6	Judge 7	Referee

Name _____

Signature _____

Lion Cup 2024 Luxembourg

297 Rue de Reckenthal L-2410 Strassen, LUXEMBOURG

Court Nr.	1	Pool	1	Date	2024-06-08	Field Position	0
RED				BLUE			
NOC	KRIJNEN THOMAS (NED)			NOC	RIBEIRO DIOGO (POR)		
Category	Kumite Male U18 -68kg						
3 Points	2 Points	1 Point	Score	1 Point	2 Points	3 Points	
			0 : 0				
Penatlity				Penatlity			
C1: C1, C2:			0:0	C1: C1, C2:			
WINNER			Total				

Decision of Superiority

Judge 1	Judge 2	Judge 3	Judge 4	Judge 5	Judge 6	Judge 7	Referee

Name _____

Signature _____

Lion Cup 2024 Luxembourg

297 Rue de Reckenthal L-2410 Strassen, LUXEMBOURG

Court Nr.	1	Pool	1	Date	2024-06-08	Field Position	2
RED				BLUE			
NOC	KRIJNEN THOMAS (NED)			NOC	TSCHARNER LOAN (SUI)		
Category	Kumite Male U18 -68kg						
3 Points	2 Points	1 Point	Score	1 Point	2 Points	3 Points	
			:				
Penatlity				Penatlity			
			Total				

Decision of Superiority

Judge 1	Judge 2	Judge 3	Judge 4	Judge 5	Judge 6	Judge 7	Referee

Name _____

Signature _____

Lion Cup 2024 Luxembourg

297 Rue de Reckenthal L-2410 Strassen, LUXEMBOURG

Court Nr.	2	Pool	2	Date	2024-06-08	Field Position	0
RED				BLUE			
NOC	ALVES LUCAS (POR)			NOC	WERFF KAI (NED)		
Category	Kumite Male U18 -68kg						
3 Points	2 Points	1 Point	Score	1 Point	2 Points	3 Points	
			0 : 6				
Penatlity				Penatlity			
C1: HC, C2:			0:6	C1: C2, C2:			
			Total	WINNER			

Decision of Superiority

Judge 1	Judge 2	Judge 3	Judge 4	Judge 5	Judge 6	Judge 7	Referee

Name _____

Signature _____

Lion Cup 2024 Luxembourg

297 Rue de Reckenthal L-2410 Strassen, LUXEMBOURG

Court Nr.	2	Pool	2	Date	2024-06-08	Field Position	2
RED				BLUE			
NOC	ALVES LUCAS (POR)			NOC	KNAROV MAXENCE (LUX)		
Category	Kumite Male U18 -68kg						
3 Points	2 Points	1 Point	Score	1 Point	2 Points	3 Points	
			0 : 3				
Penatlity				Penatlity			
C1: , C2:				0:3	C1: , C2:		
WINNER				Total			

Decision of Superiority

Judge 1	Judge 2	Judge 3	Judge 4	Judge 5	Judge 6	Judge 7	Referee

Name _____

Signature _____

Lion Cup 2024 Luxembourg - 2024-06-07

Official Results

Kumite Male U18 -68kg			
1	TORRES STEVEN		SUI - SWITZERLAND
2	LORENZ SWAN		SUI - SWITZERLAND
3	KRIJNEN THOMAS		NED - NETHERLANDS
3	WERFF KAI		NED - NETHERLANDS
5	RIBEIRO DIOGO		POR - PORTUGAL
5	ALVES LUCAS		POR - PORTUGAL
7	TSCHARNER LOAN		SUI - SWITZERLAND
7	KNAROV MAXENCE		LUX - LUXEMBOURG

KUMITE MALE U18 -76KG

Lion Cup 2024 Luxembourg

ENTRIES BY WEIGHT CATEGORY
Kumite Male U18 -76kg

As of 8 JUN 2024

NOC Code	Gender	Name	Seeding
BEL	M	tsetsilas athanasios	
LUX	M	Serra Tiago	
NED	M	Bohoudi Naoufal	
NED	M	Heupink Timo	
NED	M	Mezraui Omar	
POR	M	Ribeiro Francisco	
SUI	M	Buhurcu Jiyan	
SUI	M	Halbich Nicolas	
SUI	M	Pedro Théo	
SUI	M	Sanarica Niccolo	
SUI	M	Vogel Kaspar	
SWE	M	Hallén Mario	

Kumite Male U18 -76kg

Lion Cup 2024 Luxembourg, 297 Rue de Reckenthal L-2410 Strassen, LUX

2024-06-08

Tatami
4 11:30

Pool
1 / 1

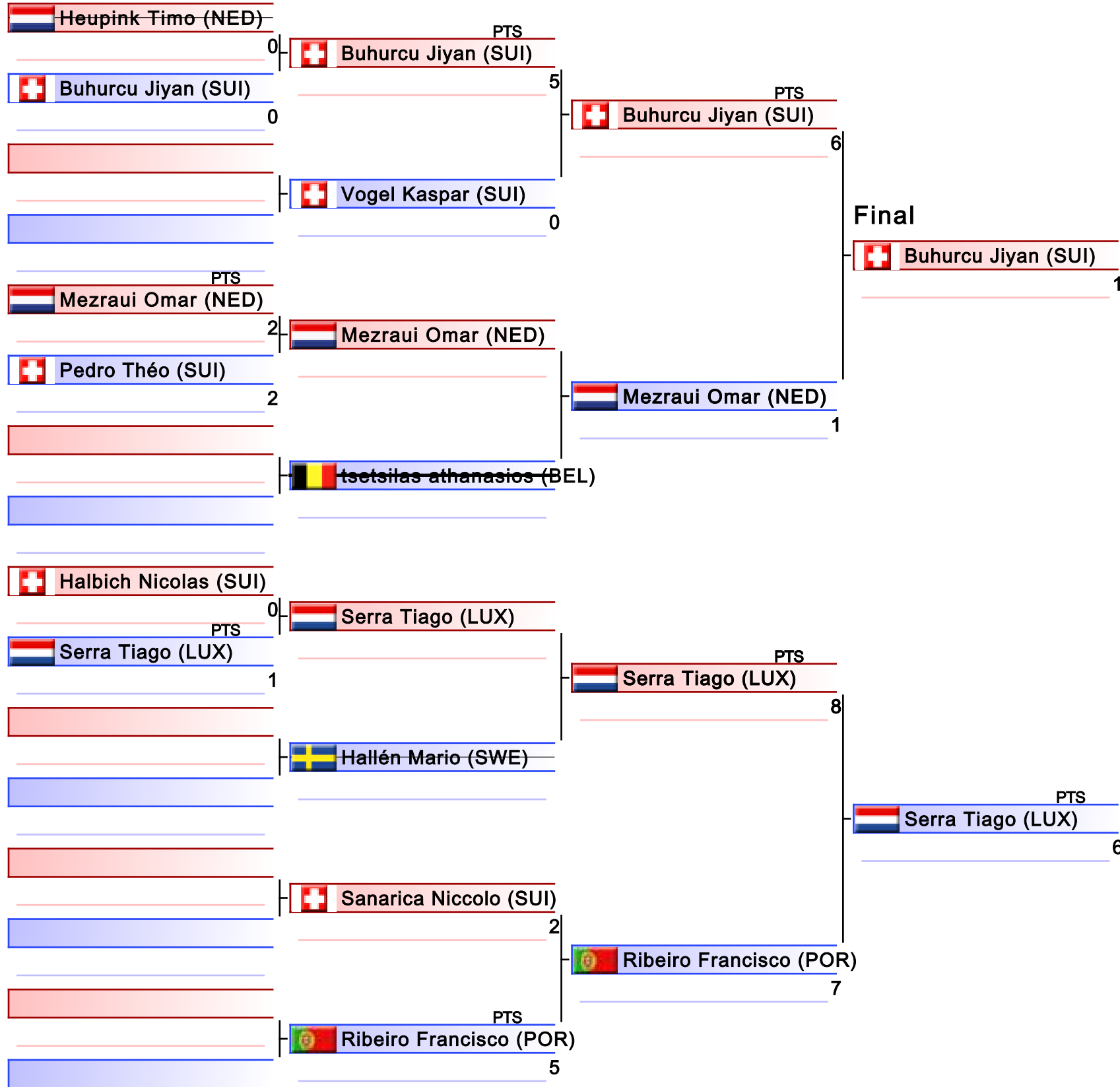

1. SERRA TIAGO (LUX)
2. BUHURCU JIYAN (SUI)
3. MEZRAUI OMAR (NED)
3. RIBEIRO FRANCISCO (POR)
5. VOGEL KASPAR (SUI)
5. HALBICH NICOLAS (SUI)

Kumite Male U18 -76kg

Lion Cup 2024 Luxembourg

2024-06-08

Tatami 4 12:10

Pool 1

(c)sportdata GmbH & Co KG 2000-2024 (2024-06-08 18:41) v 10.1.0 build 1 (2024-01-24 23:23 CET) License: Online_Event_ID-7672_LionCup2024Luxembourg (expire 2024-06-21)

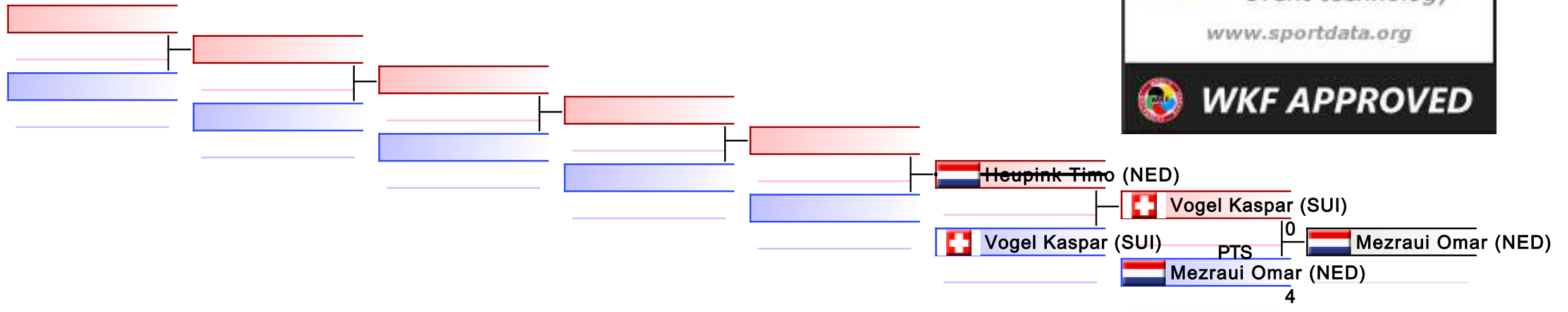

REPECHAGE: (1)

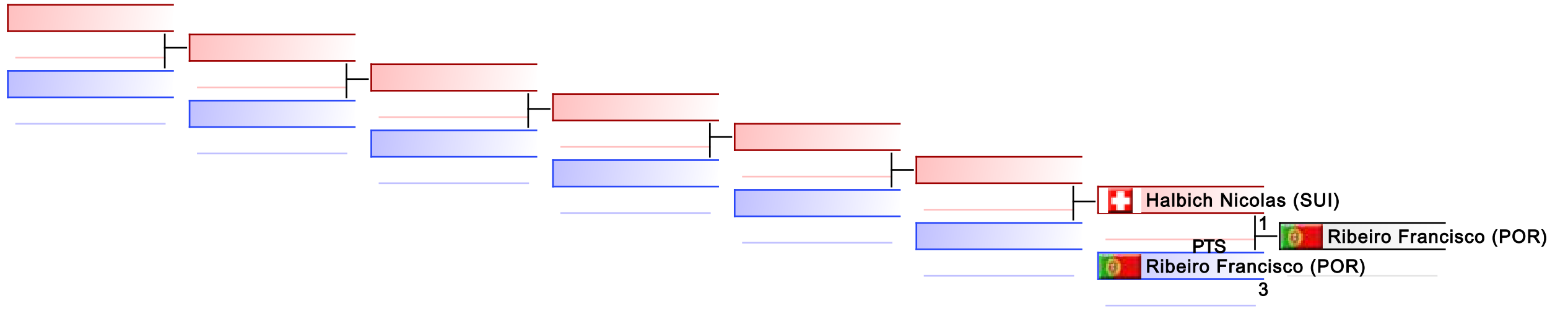

Lion Cup 2024 Luxembourg

297 Rue de Reckenthal L-2410 Strassen, LUXEMBOURG

Court Nr.	1	Pool	1	Date	2024-06-08	Field Position	51
RED				BLUE			
NOC	MEZRAUI OMAR (NED)			NOC	PEDRO THO (SUI)		
Category	Kumite Male U18 -76kg						
3 Points	2 Points	1 Point	Score	1 Point	2 Points	3 Points	
			2 : 2				
Penatlity				Penatlity			
C1: C1, C2:				2:2	C1: C3, C2:		
WINNER				Total			

PTS

Decision of Superiority

Judge 1	Judge 2	Judge 3	Judge 4	Judge 5	Judge 6	Judge 7	Referee

Name _____

Signature _____

Lion Cup 2024 Luxembourg

297 Rue de Reckenthal L-2410 Strassen, LUXEMBOURG

Court Nr.	1	Pool	1	Date	2024-06-08	Field Position	53	
RED				BLUE				
NOC	HALBICH NICOLAS (SUI)			NOC	SERRA TIAGO (LUX)			
Category	Kumite Male U18 -76kg							
3 Points	2 Points	1 Point	Score	1 Point	2 Points	3 Points		
			0 : 1					
Penatlity				Penatlity				
C1: C1, C2:				0:1	C1: C1, C2:			
				Total	WINNER			

PTS

Decision of Superiority

Judge 1	Judge 2	Judge 3	Judge 4	Judge 5	Judge 6	Judge 7	Referee

Name _____

Signature _____

Lion Cup 2024 Luxembourg

297 Rue de Reckenthal L-2410 Strassen, LUXEMBOURG

Court Nr.	1	Pool	1	Date	2024-06-08	Field Position	57	
RED				BLUE				
NOC	BUHURCU JIYAN (SUI)			NOC	VOGEL KASPAR (SUI)			
Category	Kumite Male U18 -76kg							
3 Points	2 Points	1 Point	Score	1 Point	2 Points	3 Points		
			5 : 0					
Penatlity				Penatlity				
C1: C1, C2:				5:0	C1: , C2:			
WINNER				Total				

PTS

Decision of Superiority

Judge 1	Judge 2	Judge 3	Judge 4	Judge 5	Judge 6	Judge 7	Referee

Name _____

Signature _____

Lion Cup 2024 Luxembourg

297 Rue de Reckenthal L-2410 Strassen, LUXEMBOURG

Court Nr.	1	Pool	1	Date	2024-06-08	Field Position	60
RED				BLUE			
NOC	SANARICA NICCOLO (SUI)			NOC	RIBEIRO FRANCISCO (POR)		
Category	Kumite Male U18 -76kg						
3 Points	2 Points	1 Point	Score	1 Point	2 Points	3 Points	
			2 : 5				
Penatlity				Penatlity			
C1: C1, C2:			2:5	C1: HC, C2:			
			Total	WINNER			

PTS

Decision of Superiority

Judge 1	Judge 2	Judge 3	Judge 4	Judge 5	Judge 6	Judge 7	Referee

Name _____

Signature _____

Lion Cup 2024 Luxembourg

297 Rue de Reckenthal L-2410 Strassen, LUXEMBOURG

Court Nr.	1	Pool	1	Date	2024-06-08	Field Position	61
RED				BLUE			
NOC	BUHURCU JIYAN (SUI)			NOC	MEZRAUI OMAR (NED)		
Category	Kumite Male U18 -76kg						
3 Points	2 Points	1 Point	Score	1 Point	2 Points	3 Points	
			6 : 1				
Penatlity					Penatlity		
C1: HC, C2:				6:1	C1: , C2:		
WINNER				Total			

PTS

Decision of Superiority

Judge 1	Judge 2	Judge 3	Judge 4	Judge 5	Judge 6	Judge 7	Referee

Name _____

Signature _____

Lion Cup 2024 Luxembourg

297 Rue de Reckenthal L-2410 Strassen, LUXEMBOURG

Court Nr.	1	Pool	1	Date	2024-06-08	Field Position	62
RED				BLUE			
NOC	SERRA TIAGO (LUX)			NOC	RIBEIRO FRANCISCO (POR)		
Category	Kumite Male U18 -76kg						
3 Points	2 Points	1 Point	Score	1 Point	2 Points	3 Points	
			8 : 7				
Penatlity				Penatlity			
C1: HC, C2:			8:7	C1: C1, C2:			
WINNER			Total				

PTS

Decision of Superiority

Judge 1	Judge 2	Judge 3	Judge 4	Judge 5	Judge 6	Judge 7	Referee

Name _____

Signature _____

Lion Cup 2024 Luxembourg

297 Rue de Reckenthal L-2410 Strassen, LUXEMBOURG

Court Nr.	1	Pool	1	Date	2024-06-08	Field Position	63	
RED				BLUE				
NOC	BUHURCU JIYAN (SUI)			NOC	SERRA TIAGO (LUX)			
Category	Kumite Male U18 -76kg							
3 Points	2 Points	1 Point	Score	1 Point	2 Points	3 Points		
			1 : 6					
Penatlity				Penatlity				
C1: , C2:				1:6	C1: HC, C2:			
				Total	WINNER			

PTS

Decision of Superiority

Judge 1	Judge 2	Judge 3	Judge 4	Judge 5	Judge 6	Judge 7	Referee

Name _____

Signature _____

Lion Cup 2024 Luxembourg

297 Rue de Reckenthal L-2410 Strassen, LUXEMBOURG

Court Nr.	1	Pool	1	Date	2024-06-08	Field Position	0	
RED				BLUE				
NOC	VOGEL KASPAR (SUI)			NOC	MEZRAUI OMAR (NED)			
Category	Kumite Male U18 -76kg							
3 Points	2 Points	1 Point	Score	1 Point	2 Points	3 Points		
			0 : 4					
Penatlity				Penatlity				
C1: C1, C2:				0:4	C1: C3, C2:			
				Total	WINNER			

PTS

Decision of Superiority

Judge 1	Judge 2	Judge 3	Judge 4	Judge 5	Judge 6	Judge 7	Referee

Name _____

Signature _____

Lion Cup 2024 Luxembourg

297 Rue de Reckenthal L-2410 Strassen, LUXEMBOURG

Court Nr.	2	Pool	2	Date	2024-06-08	Field Position	0	
RED				BLUE				
NOC	HALBICH NICOLAS (SUI)			NOC	RIBEIRO FRANCISCO (POR)			
Category	Kumite Male U18 -76kg							
3 Points	2 Points	1 Point	Score	1 Point	2 Points	3 Points		
			1 : 3					
Penatlity				Penatlity				
C1: , C2:				1:3	C1: , C2:			
				Total	WINNER			

PTS

Decision of Superiority



Judge 1	Judge 2	Judge 3	Judge 4	Judge 5	Judge 6	Judge 7	Referee

Name _____

Signature _____

Lion Cup 2024 Luxembourg - 2024-06-07

Official Results

Kumite Male U18 -76kg			
1	SERRA TIAGO		LUX - LUXEMBOURG
2	BUHURCU JIYAN		SUI - SWITZERLAND
3	MEZRAUI OMAR		NED - NETHERLANDS
3	RIBEIRO FRANCISCO		POR - PORTUGAL
5	VOGEL KASPAR		SUI - SWITZERLAND
5	HALBICH NICOLAS		SUI - SWITZERLAND

KUMITE MALE U21 -75KG

Lion Cup 2024 Luxembourg

ENTRIES BY WEIGHT CATEGORY
Kumite Male U21 -75kg

As of 8 JUN 2024

NOC Code	Gender	Name	Seeding
AUT	M	Grigorasenco Nichita	
BEL	M	Panza Ethan	
BEL	M	Roland Tom	
BEL	M	Yuksektepe Hamza	
IRL	M	Kelly Anthony	
LUX	M	Almalh Mahmoud	
LUX	M	Sibille Jordan	
LUX	M	Terlica Gomes Sebastien	
NED	M	Boudewijns Dennis	
NED	M	Teeffelen van Sebastiaan	
NED	M	Wattilete Gerson	
SUI	M	Baranyi Barnabas	
SUI	M	Del Medico Manuel	
SUI	M	OBERSON Antoine	
SUI	M	Sparer Nico	
SUI	M	Vranjes Andrej	

Kumite Male U21 -75kg

Lion Cup 2024 Luxembourg, 297 Rue de Reckenthal L-2410 Strassen, LUX

2024-06-08

Tatami

3 11:50

Pool

1 / 1

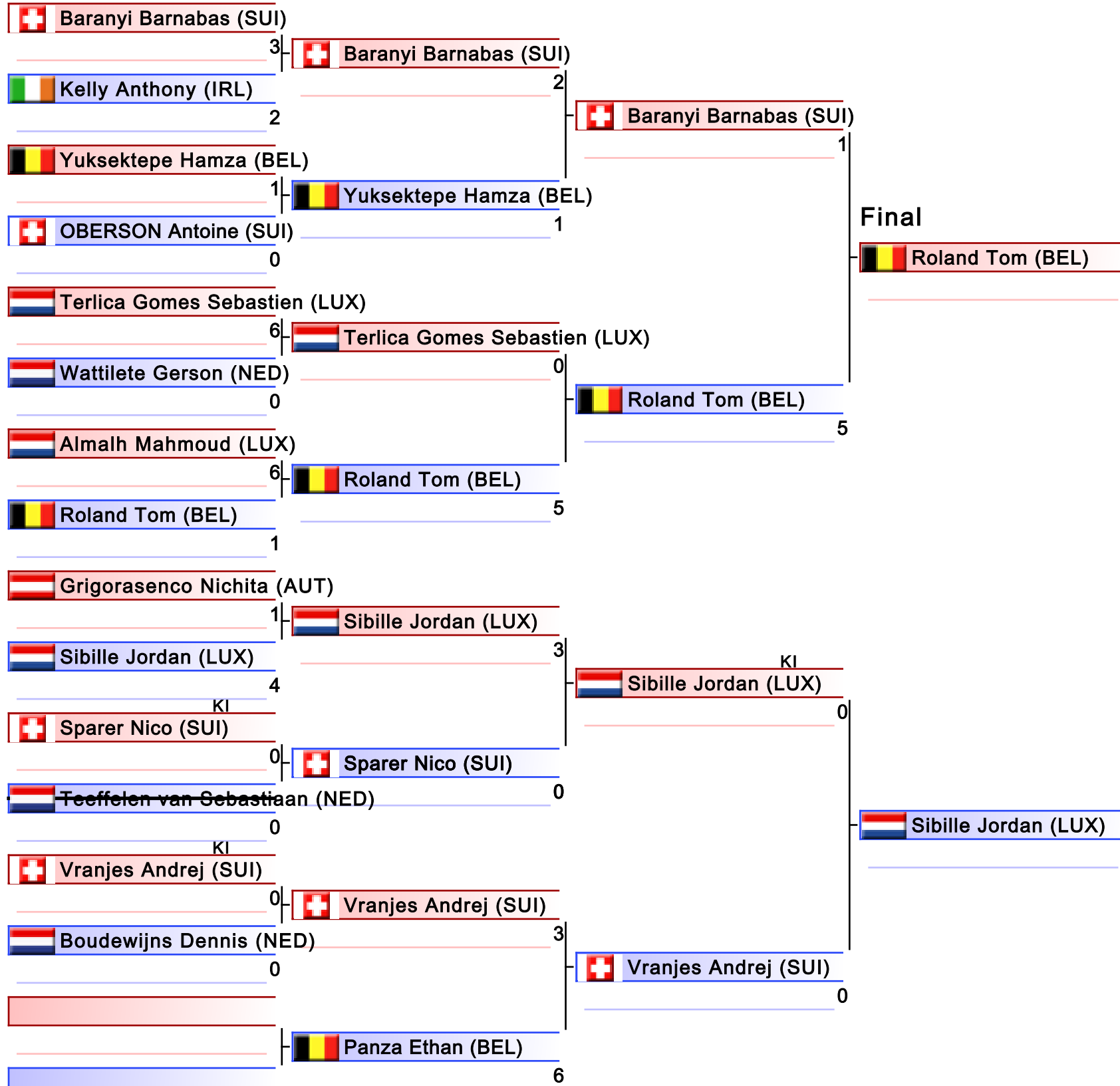

1. SIBILLE JORDAN (LUX)
2. ROLAND TOM (BEL)
3. GRIGORASENCO NICHITA (AUT)
3. ALMALH MAHMOUD (LUX)
5. VRANJES ANDREJ (SUI)
5. BARANYI BARNABAS (SUI)
7. SPARER NICO (SUI)
7. TERLICA GOMES SEBASTIEN (LUX)

Kumite Male U21 -75kg

Lion Cup 2024 Luxembourg

2024-06-08

Tatami 3 12:35

Pool 1

(c)sportdata GmbH & Co KG 2000-2024 (2024-06-08 18:41) v 10.1.0 build 1 (2024-01-24 23:23 CET) License: Online_Event_ID-7672_LionCup2024Luxembourg (expire 2024-06-21)

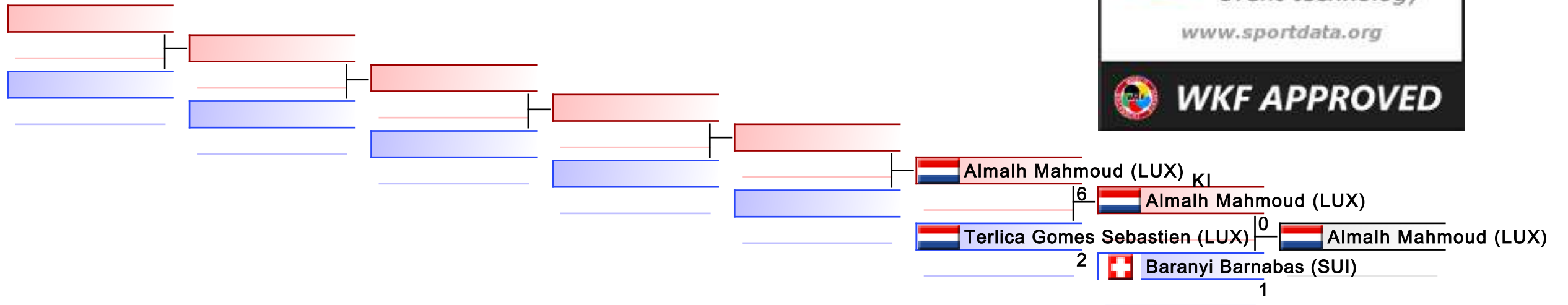

REPECHAGE: (1)

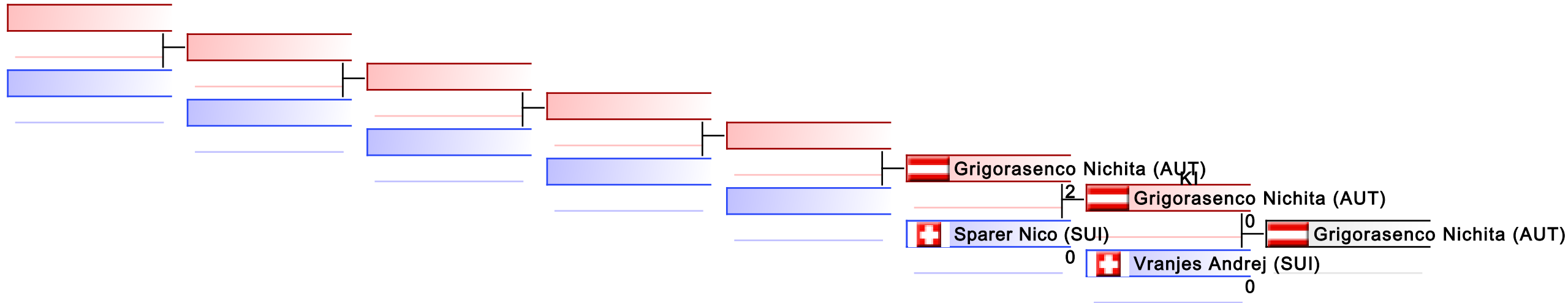

Lion Cup 2024 Luxembourg

297 Rue de Reckenthal L-2410 Strassen, LUXEMBOURG

Court Nr.	1	Pool	1	Date	2024-06-08	Field Position	49
RED				BLUE			
NOC	BARANYI BARNABAS (SUI)			NOC	KELLY ANTHONY (IRL)		
Category	Kumite Male U21 -75kg						
3 Points	2 Points	1 Point	Score	1 Point	2 Points	3 Points	
			3 : 2				
Penatlity				Penatlity			
C1: C1, C2:				3:2	C1: , C2:		
WINNER				Total			

Decision of Superiority

Judge 1	Judge 2	Judge 3	Judge 4	Judge 5	Judge 6	Judge 7	Referee

Name _____

Signature _____

Lion Cup 2024 Luxembourg

297 Rue de Reckenthal L-2410 Strassen, LUXEMBOURG

Court Nr.	1	Pool	1	Date	2024-06-08	Field Position	50
RED				BLUE			
NOC	YUKSEKTEPE HAMZA (BEL)			NOC	OBERSON ANTOINE (SUI)		
Category	Kumite Male U21 -75kg						
3 Points	2 Points	1 Point	Score	1 Point	2 Points	3 Points	
			1 : 0				
Penatlity				Penatlity			
C1: C1, C2:				1:0	C1: , C2:		
WINNER				Total			

Decision of Superiority

Judge 1	Judge 2	Judge 3	Judge 4	Judge 5	Judge 6	Judge 7	Referee

Name _____

Signature _____

Lion Cup 2024 Luxembourg

297 Rue de Reckenthal L-2410 Strassen, LUXEMBOURG

Court Nr.	1	Pool	1	Date	2024-06-08	Field Position	51
RED				BLUE			
NOC	TERLICA GOMES SEBASTIEN (LUX)			NOC	WATTILETE GERSON (NED)		
Category	Kumite Male U21 -75kg						
3 Points	2 Points	1 Point	Score	1 Point	2 Points	3 Points	
			6 : 0				
Penatlity				Penatlity			
C1: HC, C2:				6:0	C1: , C2:		
WINNER				Total			

Decision of Superiority

Judge 1	Judge 2	Judge 3	Judge 4	Judge 5	Judge 6	Judge 7	Referee

Name _____

Signature _____

Lion Cup 2024 Luxembourg

297 Rue de Reckenthal L-2410 Strassen, LUXEMBOURG

Court Nr.	1	Pool	1	Date	2024-06-08	Field Position	52
RED				BLUE			
NOC	ALMALH MAHMOUD (LUX)			NOC	ROLAND TOM (BEL)		
Category	Kumite Male U21 -75kg						
3 Points	2 Points	1 Point	Score	1 Point	2 Points	3 Points	
			6 : 1				
Penatlity				Penatlity			
C1: H, C2:			6:1	C1: , C2:			
			Total	WINNER			

Decision of Superiority

Judge 1	Judge 2	Judge 3	Judge 4	Judge 5	Judge 6	Judge 7	Referee

Name _____

Signature _____

Lion Cup 2024 Luxembourg

297 Rue de Reckenthal L-2410 Strassen, LUXEMBOURG

Court Nr.	1	Pool	1	Date	2024-06-08	Field Position	53
RED				BLUE			
NOC	GRIGORASENCO NICHITA (AUT)			NOC	SIBILLE JORDAN (LUX)		
Category	Kumite Male U21 -75kg						
3 Points	2 Points	1 Point	Score	1 Point	2 Points	3 Points	
			1 : 4				
Penatlity				Penatlity			
C1: , C2:			1:4	C1: HC, C2:			
			Total	WINNER			

Decision of Superiority

Judge 1	Judge 2	Judge 3	Judge 4	Judge 5	Judge 6	Judge 7	Referee

Name _____

Signature _____

Lion Cup 2024 Luxembourg

297 Rue de Reckenthal L-2410 Strassen, LUXEMBOURG

Court Nr.	1	Pool	1	Date	2024-06-08	Field Position	55
RED				BLUE			
NOC	VRANJES ANDREJ (SUI)			NOC	BOUDEWIJNS DENNIS (NED)		
Category	Kumite Male U21 -75kg						
3 Points	2 Points	1 Point	Score	1 Point	2 Points	3 Points	
			0 : 0				
Penatlity				Penatlity			
C1: , C2:				0:0	C1: , C2:		
WINNER				Total			

Decision of Superiority

Judge 1	Judge 2	Judge 3	Judge 4	Judge 5	Judge 6	Judge 7	Referee

Name _____

Signature _____

Lion Cup 2024 Luxembourg

297 Rue de Reckenthal L-2410 Strassen, LUXEMBOURG

Court Nr.	1	Pool	1	Date	2024-06-08	Field Position	57	
RED				BLUE				
NOC	BARANYI BARNABAS (SUI)			NOC	YUKSEKTEPE HAMZA (BEL)			
Category	Kumite Male U21 -75kg							
3 Points	2 Points	1 Point	Score	1 Point	2 Points	3 Points		
			2 : 1					
Penatlity				Penatlity				
C1: HC, C2:				2:1	C1: HC, C2:			
WINNER				Total				

Decision of Superiority

Judge 1	Judge 2	Judge 3	Judge 4	Judge 5	Judge 6	Judge 7	Referee

Name _____

Signature _____

Lion Cup 2024 Luxembourg

297 Rue de Reckenthal L-2410 Strassen, LUXEMBOURG

Court Nr.	1	Pool	1	Date	2024-06-08	Field Position	58	
RED				BLUE				
NOC	TERLICA GOMES SEBASTIEN (LUX)			NOC	ROLAND TOM (BEL)			
Category	Kumite Male U21 -75kg							
3 Points	2 Points	1 Point	Score	1 Point	2 Points	3 Points		
			0 : 5					
Penatlity				Penatlity				
C1: C1, C2:				0:5	C1: , C2:			
				Total	WINNER			

Decision of Superiority

Judge 1	Judge 2	Judge 3	Judge 4	Judge 5	Judge 6	Judge 7	Referee

Name _____

Signature _____

Lion Cup 2024 Luxembourg

297 Rue de Reckenthal L-2410 Strassen, LUXEMBOURG

Court Nr.	1	Pool	1	Date	2024-06-08	Field Position	59
RED				BLUE			
NOC	SIBILLE JORDAN (LUX)			NOC	SPARER NICO (SUI)		
Category	Kumite Male U21 -75kg						
3 Points	2 Points	1 Point	Score	1 Point	2 Points	3 Points	
			3 : 0				
Penatlity				Penatlity			
C1: HC, C2:				3:0	C1: C1, C2:		
WINNER				Total			

Decision of Superiority

Judge 1	Judge 2	Judge 3	Judge 4	Judge 5	Judge 6	Judge 7	Referee

Name _____

Signature _____

Lion Cup 2024 Luxembourg

297 Rue de Reckenthal L-2410 Strassen, LUXEMBOURG

Court Nr.	1	Pool	1	Date	2024-06-08	Field Position	60
RED				BLUE			
NOC	VRANJES ANDREJ (SUI)			NOC	PANZA ETHAN (BEL)		
Category	Kumite Male U21 -75kg						
3 Points	2 Points	1 Point	Score	1 Point	2 Points	3 Points	
			3 : 6				
Penatlity				Penatlity			
C1: C2, C2:				3:6	C1: H, C2:		
WINNER				Total			

Decision of Superiority

Judge 1	Judge 2	Judge 3	Judge 4	Judge 5	Judge 6	Judge 7	Referee

Name _____

Signature _____

Lion Cup 2024 Luxembourg

297 Rue de Reckenthal L-2410 Strassen, LUXEMBOURG

Court Nr.	1	Pool	1	Date	2024-06-08	Field Position	61	
RED				BLUE				
NOC	BARANYI BARNABAS (SUI)			NOC	ROLAND TOM (BEL)			
Category	Kumite Male U21 -75kg							
3 Points	2 Points	1 Point	Score	1 Point	2 Points	3 Points		
			1 : 5					
Penatlity				Penatlity				
C1: C1, C2:				1:5	C1: HC, C2:			
				Total	WINNER			

Decision of Superiority

Judge 1	Judge 2	Judge 3	Judge 4	Judge 5	Judge 6	Judge 7	Referee

Name _____

Signature _____

Lion Cup 2024 Luxembourg

297 Rue de Reckenthal L-2410 Strassen, LUXEMBOURG

Court Nr.	1	Pool	1	Date	2024-06-08	Field Position	62
RED				BLUE			
NOC	SIBILLE JORDAN (LUX)			NOC	VRANJES ANDREJ (SUI)		
Category	Kumite Male U21 -75kg						
3 Points	2 Points	1 Point	Score	1 Point	2 Points	3 Points	
			0 : 0				
Penatlity				Penatlity			
C1: , C2:				0:0	C1: , C2:		
WINNER				Total			

Decision of Superiority

Judge 1	Judge 2	Judge 3	Judge 4	Judge 5	Judge 6	Judge 7	Referee

Name _____

Signature _____

Lion Cup 2024 Luxembourg

297 Rue de Reckenthal L-2410 Strassen, LUXEMBOURG

Court Nr.	1	Pool	1	Date	2024-06-08	Field Position	63	
RED				BLUE				
NOC	ROLAND TOM (BEL)			NOC	SIBILLE JORDAN (LUX)			
Category	Kumite Male U21 -75kg							
3 Points	2 Points	1 Point	Score	1 Point	2 Points	3 Points		
			1 : 9					
Penatlity				Penatlity				
C1: HC, C2:				1:9	C1: C2, C2:			
				Total	WINNER			

Decision of Superiority

Judge 1	Judge 2	Judge 3	Judge 4	Judge 5	Judge 6	Judge 7	Referee

Name _____

Signature _____

Lion Cup 2024 Luxembourg

297 Rue de Reckenthal L-2410 Strassen, LUXEMBOURG

Court Nr.	1	Pool	1	Date	2024-06-08	Field Position	0
RED				BLUE			
NOC	ALMALH MAHMOUD (LUX)			NOC	BARANYI BARNABAS (SUI)		
Category	Kumite Male U21 -75kg						
3 Points	2 Points	1 Point	Score	1 Point	2 Points	3 Points	
			0 : 1				
Penatlity				Penatlity			
C1: C2, C2:				0:1	C1: C3, C2:		
WINNER				Total			

KI

Decision of Superiority

Judge 1	Judge 2	Judge 3	Judge 4	Judge 5	Judge 6	Judge 7	Referee

Name _____

Signature _____

Lion Cup 2024 Luxembourg

297 Rue de Reckenthal L-2410 Strassen, LUXEMBOURG

Court Nr.	1	Pool	1	Date	2024-06-08	Field Position	2	
RED				BLUE				
NOC	ALMALH MAHMOUD (LUX)			NOC	TERLICA GOMES SEBASTIEN (LUX)			
Category	Kumite Male U21 -75kg							
3 Points	2 Points	1 Point	Score	1 Point	2 Points	3 Points		
			6 : 2					
Penatlity				Penatlity				
C1: C3, C2:				6:2	C1: HC, C2:			
WINNER				Total				

Decision of Superiority

Judge 1	Judge 2	Judge 3	Judge 4	Judge 5	Judge 6	Judge 7	Referee

Name _____

Signature _____

Lion Cup 2024 Luxembourg

297 Rue de Reckenthal L-2410 Strassen, LUXEMBOURG

Court Nr.	2	Pool	2	Date	2024-06-08	Field Position	0
RED				BLUE			
NOC	GRIGORASENCO NICHITA (AUT)			NOC	VRANJES ANDREJ (SUI)		
Category	Kumite Male U21 -75kg						
3 Points	2 Points	1 Point	Score	1 Point	2 Points	3 Points	
			0 : 0				
Penatlity					Penatlity		
C1: , C2:				0:0	C1: , C2:		
WINNER				Total			

KI

Decision of Superiority

Judge 1	Judge 2	Judge 3	Judge 4	Judge 5	Judge 6	Judge 7	Referee

Name _____

Signature _____

Lion Cup 2024 Luxembourg

297 Rue de Reckenthal L-2410 Strassen, LUXEMBOURG

Court Nr.	2	Pool	2	Date	2024-06-08	Field Position	2
RED				BLUE			
NOC	GRIGORASENCO NICHITA (AUT)			NOC	SPARER NICO (SUI)		
Category	Kumite Male U21 -75kg						
3 Points	2 Points	1 Point	Score	1 Point	2 Points	3 Points	
			:				
Penatlity				Penatlity			
			Total				

Decision of Superiority

Judge 1	Judge 2	Judge 3	Judge 4	Judge 5	Judge 6	Judge 7	Referee

Name _____

Signature _____

Official Results

Kumite Male U21 -75kg			
1	SIBILLE JORDAN		LUX - LUXEMBOURG
2	ROLAND TOM		BEL - BELGIUM
3	GRIGORASENCO NICHITA		AUT - AUSTRIA
3	ALMALH MAHMOUD		LUX - LUXEMBOURG
5	VRANJES ANDREJ		SUI - SWITZERLAND
5	BARANYI BARNABAS		SUI - SWITZERLAND
7	SPARER NICO		SUI - SWITZERLAND
7	TERLICA GOMES SEBASTIEN		LUX - LUXEMBOURG

KUMITE MALE U21 -84KG/+84KG

Lion Cup 2024 Luxembourg

ENTRIES BY WEIGHT CATEGORY
Kumite Male U21 -84kg/+84kg

As of 8 JUN 2024

NOC Code	Gender	Name	Seeding
BEL	M	Anisimov Danyil	
BEL	M	El mesbahi ali	
POR	M	Fernandes Fábio	
SUI	M	Dobberstein Lennox	
SUI	M	Kabashi John	
SUI	M	Rouèche David	

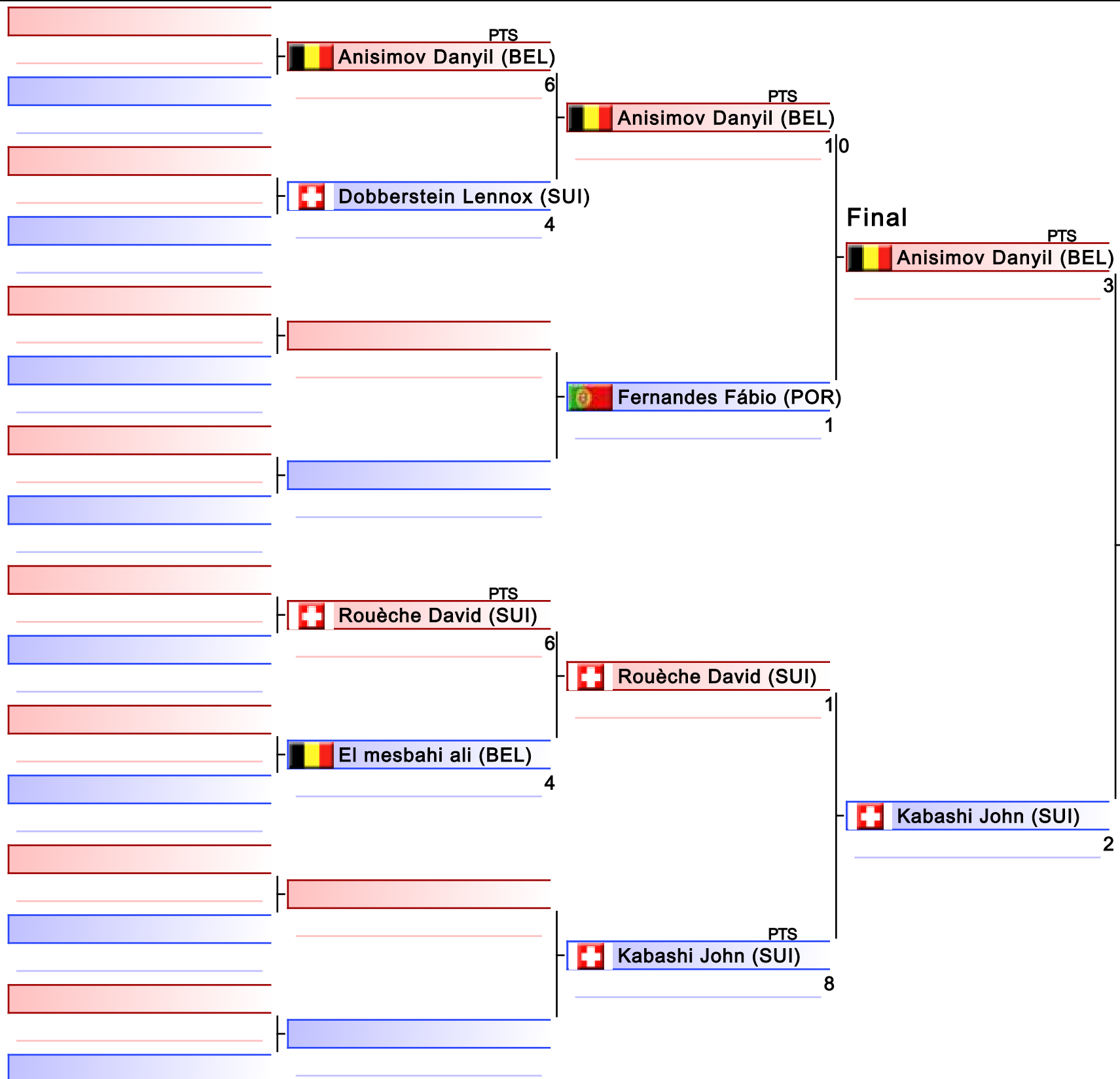

1. ANISIMOV DANYIL (BEL)
2. KABASHI JOHN (SUI)
3. ROUÈCHE DAVID (SUI)
3. DOBBERSTEIN LENNOX (SUI)
5. FERNANDES FÁBIO (POR)

Kumite Male U21 -84kg/+84kg

Lion Cup 2024 Luxembourg

2024-06-08

Tatami 1 12:20

Pool 1

(c)sportdata GmbH & Co KG 2000-2024 (2024-06-08 18:41) v 10.1.0 build 1 (2024-01-24 23:23 CET) License: Online_Event_ID-7672_LionCup2024Luxembourg (expire 2024-06-21)

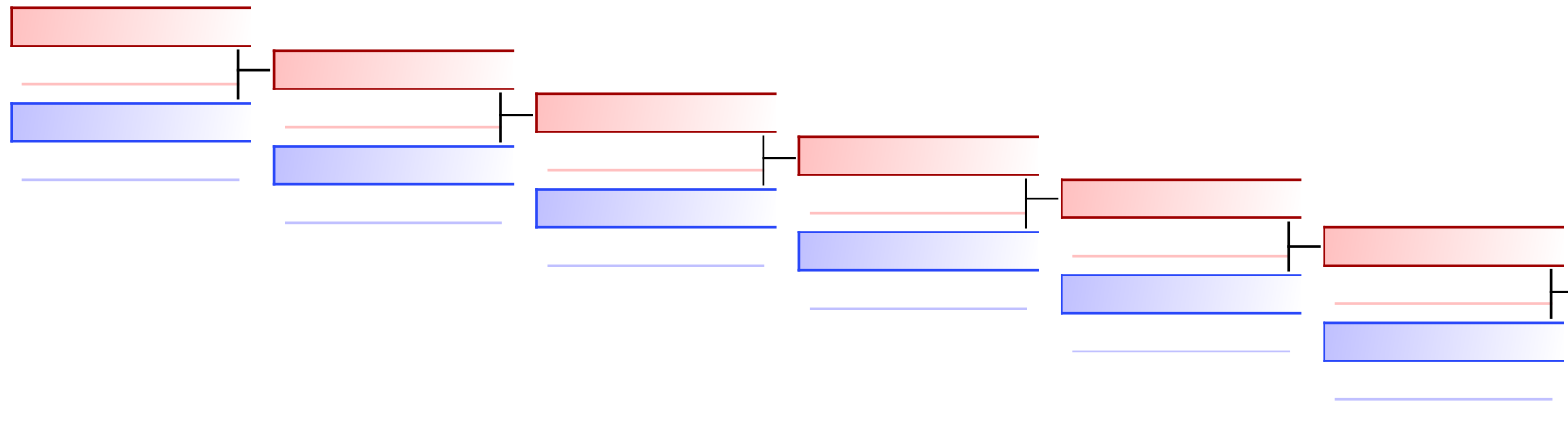

PTS
 Dobberstein Lennox (SUI) 5
 Dobberstein Lennox (SUI)
 Fernandes Fábio (POR) 2

REPECHAGE: (1)

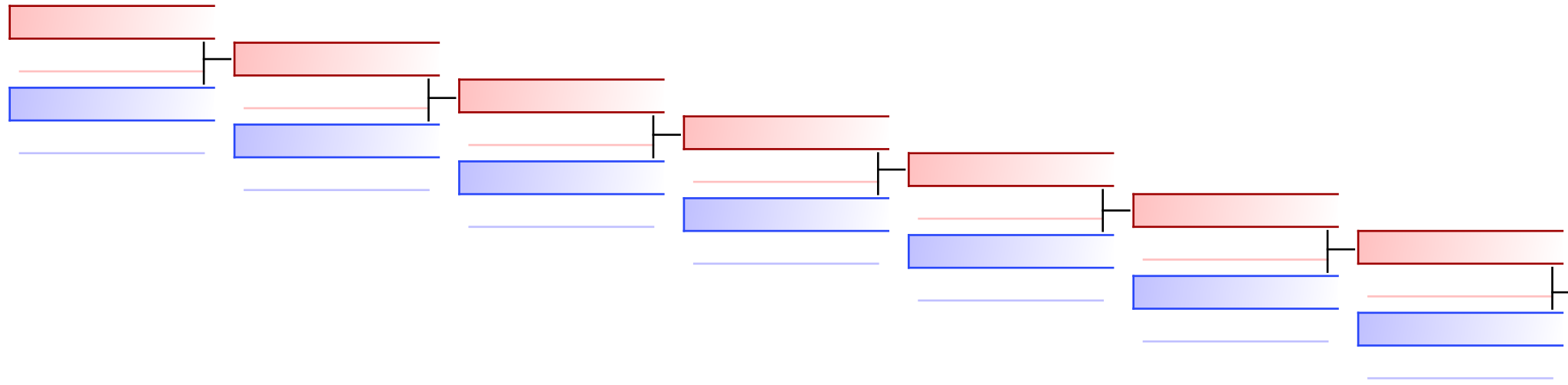

Rouèche David (SUI)

Lion Cup 2024 Luxembourg

297 Rue de Reckenthal L-2410 Strassen, LUXEMBOURG

Court Nr.	1	Pool	1	Date	2024-06-08	Field Position	57	
RED				BLUE				
NOC	ANISIMOV DANYIL (BEL)			NOC	DOBBERSTEIN LENNOX (SUI)			
Category	Kumite Male U21 -84kg/+84kg							
3 Points	2 Points	1 Point	Score	1 Point	2 Points	3 Points		
			6 : 4					
Penatlity				Penatlity				
C1: , C2:				6:4	C1: C3, C2:			
WINNER				Total				

PTS

Decision of Superiority

Judge 1	Judge 2	Judge 3	Judge 4	Judge 5	Judge 6	Judge 7	Referee

Name _____

Signature _____

Lion Cup 2024 Luxembourg

297 Rue de Reckenthal L-2410 Strassen, LUXEMBOURG

Court Nr.	1	Pool	1	Date	2024-06-08	Field Position	59	
RED				BLUE				
NOC	ROUCHE DAVID (SUI)			NOC	EL MESBAHI ALI (BEL)			
Category	Kumite Male U21 -84kg/+84kg							
3 Points	2 Points	1 Point	Score	1 Point	2 Points	3 Points		
			6 : 4					
Penatlity				Penatlity				
C1: , C2:				6:4	C1: C3, C2:			
WINNER				Total				

PTS

Decision of Superiority

Judge 1	Judge 2	Judge 3	Judge 4	Judge 5	Judge 6	Judge 7	Referee

Name _____

Signature _____

Lion Cup 2024 Luxembourg

297 Rue de Reckenthal L-2410 Strassen, LUXEMBOURG

Court Nr.	1	Pool	1	Date	2024-06-08	Field Position	61	
RED				BLUE				
NOC	ANISIMOV DANYIL (BEL)			NOC	FERNANDES FBIO (POR)			
Category	Kumite Male U21 -84kg/+84kg							
3 Points	2 Points	1 Point	Score	1 Point	2 Points	3 Points		
			10 : 1					
Penatlity				Penatlity				
			C1: , C2:	10:1				C1: C1, C2:
			WINNER	Total				

PTS

Decision of Superiority

Judge 1	Judge 2	Judge 3	Judge 4	Judge 5	Judge 6	Judge 7	Referee

Name _____

Signature _____

Lion Cup 2024 Luxembourg

297 Rue de Reckenthal L-2410 Strassen, LUXEMBOURG

Court Nr.	1	Pool	1	Date	2024-06-08	Field Position	62	
RED				BLUE				
NOC	ROUCHE DAVID (SUI)			NOC	KABASHI JOHN (SUI)			
Category	Kumite Male U21 -84kg/+84kg							
3 Points	2 Points	1 Point	Score	1 Point	2 Points	3 Points		
			1 : 8					
Penatlity				Penatlity				
C1: C2, C2:				1:8	C1: C2, C2:			
				Total	WINNER			

PTS

Decision of Superiority

Judge 1	Judge 2	Judge 3	Judge 4	Judge 5	Judge 6	Judge 7	Referee

Name _____

Signature _____

Lion Cup 2024 Luxembourg

297 Rue de Reckenthal L-2410 Strassen, LUXEMBOURG

Court Nr.	1	Pool	1	Date	2024-06-08	Field Position	63
RED				BLUE			
NOC	ANISIMOV DANYIL (BEL)			NOC	KABASHI JOHN (SUI)		
Category	Kumite Male U21 -84kg/+84kg						
3 Points	2 Points	1 Point	Score	1 Point	2 Points	3 Points	
			3 : 2				
Penatlity				Penatlity			
C1: C2, C2:				3:2	C1: C1, C2:		
WINNER				Total			

PTS

Decision of Superiority

Judge 1	Judge 2	Judge 3	Judge 4	Judge 5	Judge 6	Judge 7	Referee

Name _____

Signature _____

Lion Cup 2024 Luxembourg

297 Rue de Reckenthal L-2410 Strassen, LUXEMBOURG

Court Nr.	1	Pool	1	Date	2024-06-08	Field Position	0
RED				BLUE			
NOC	DOBBERSTEIN LENNOX (SUI)			NOC	FERNANDES FBIO (POR)		
Category	Kumite Male U21 -84kg/+84kg						
3 Points	2 Points	1 Point	Score	1 Point	2 Points	3 Points	
			:				
Penatlity				Penatlity			
			Total				

Decision of Superiority

Judge 1	Judge 2	Judge 3	Judge 4	Judge 5	Judge 6	Judge 7	Referee

Name _____

Signature _____

Official Results

Kumite Male U21 -84kg/+84kg			
1	ANISIMOV DANYIL		BEL - BELGIUM
2	KABASHI JOHN		SUI - SWITZERLAND
3	ROUËCHE DAVID		SUI - SWITZERLAND
3	DOBBERSTEIN LENNOX		SUI - SWITZERLAND
5	FERNANDES FÁBIO		POR - PORTUGAL

KUMITE MALE U21 - 60KG

Lion Cup 2024 Luxembourg

ENTRIES BY WEIGHT CATEGORY
Kumite Male U21 - 60kg

As of 8 JUN 2024

NOC Code	Gender	Name	Seeding
AUT	M	Lang Marcus	
FRA	M	PICAZO LUQUE Angel	
LUX	M	Coimbra Pol	
LUX	M	Teixeira Tomas	
NOR	M	Hansen Henrik Walstad	
SUI	M	Schmid Samuel	

Kumite Male U21 - 60kg

Lion Cup 2024 Luxembourg, 297 Rue de Reckenthal L-2410 Strassen, LUX

2024-06-08

Tatami
4 12:30

Pool
1 / 1

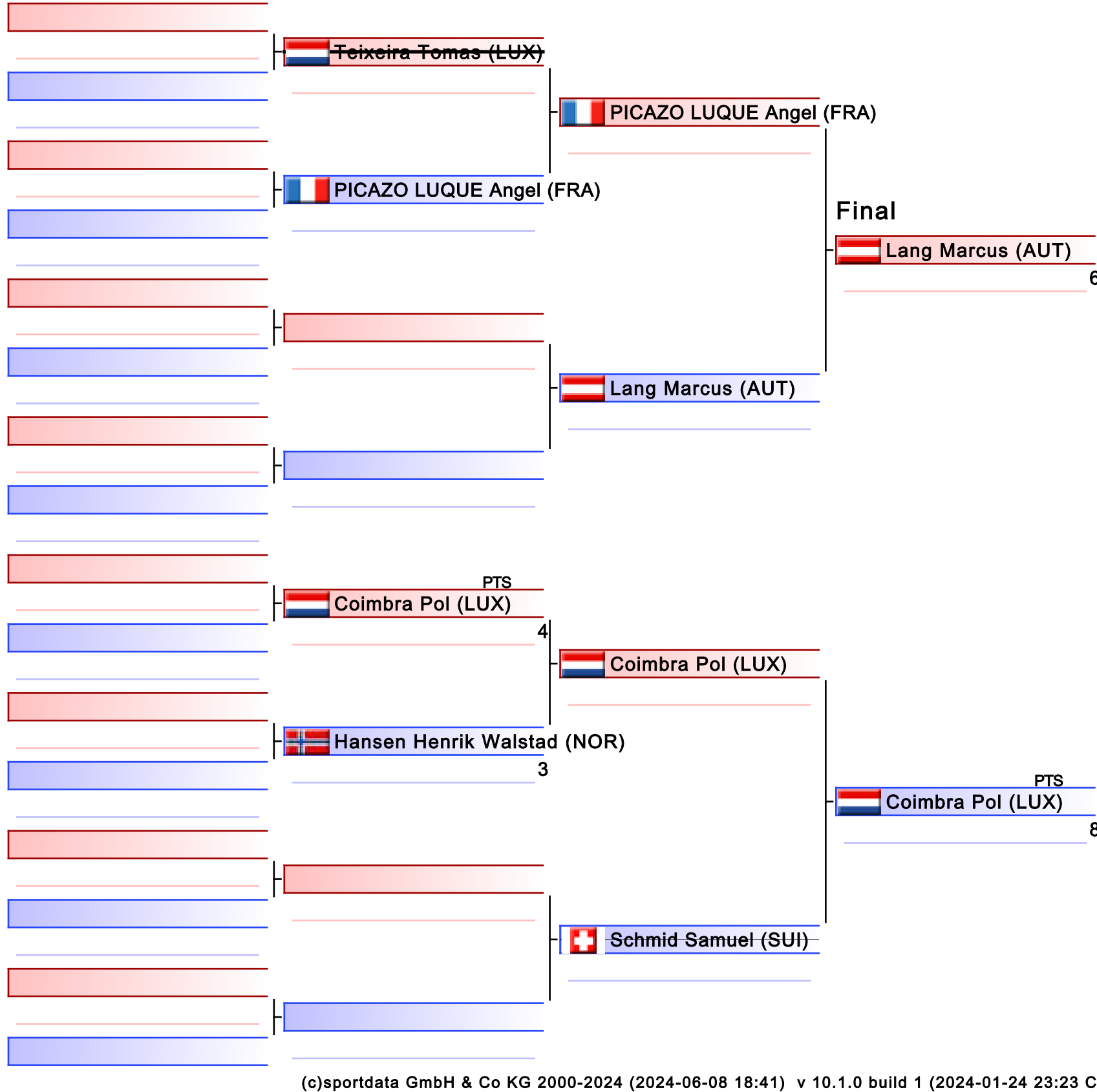

1. COIMBRA POL (LUX)
2. LANG MARCUS (AUT)
3. HANSEN HENRIK WALSTAD (NOR)

Kumite Male U21 - 60kg

Lion Cup 2024 Luxembourg

2024-06-08

Tatami
4 12:45

Pool
1

(c)sportdata GmbH & Co KG 2000-2024 (2024-06-08 18:41) v 10.1.0 build 1 (2024-01-24 23:23 CET) License: Online_Event_ID-7672_LionCup2024Luxembourg (expire 2024-06-21)

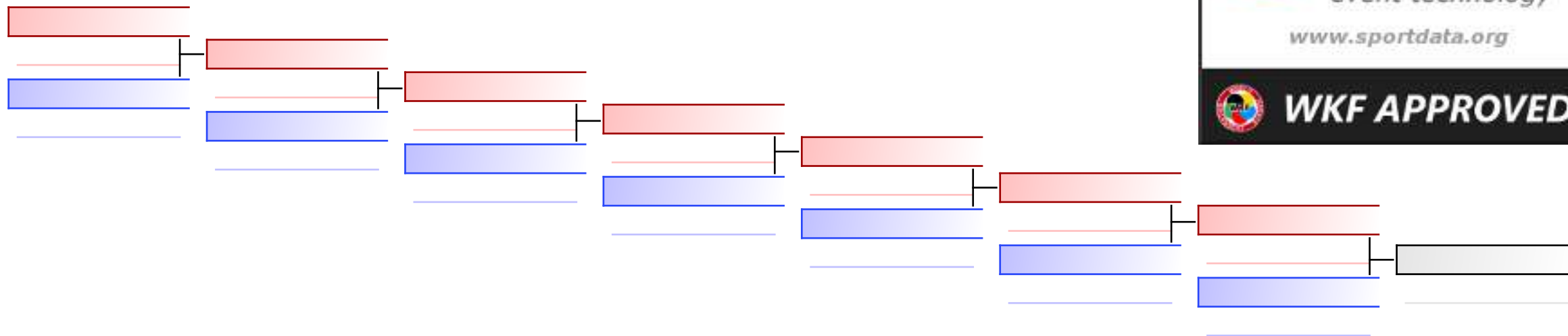

REPECHAGE: (1)

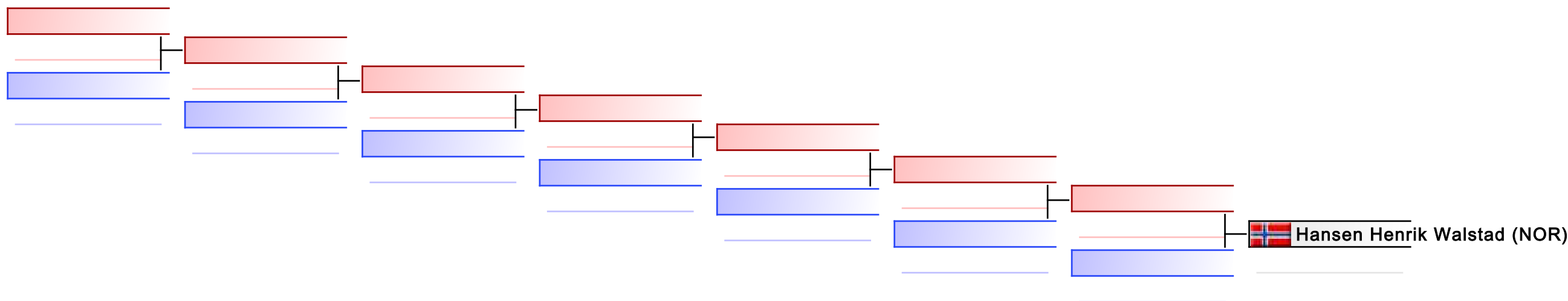

Lion Cup 2024 Luxembourg

297 Rue de Reckenthal L-2410 Strassen, LUXEMBOURG

Court Nr.	1	Pool	1	Date	2024-06-08	Field Position	59
RED				BLUE			
NOC	COIMBRA POL (LUX)			NOC	HANSEN HENRIK WALSTAD (NOR)		
Category	Kumite Male U21 - 60kg						
3 Points	2 Points	1 Point	Score	1 Point	2 Points	3 Points	
			4 : 3				
Penatlity				Penatlity			
C1: HC, C2:				4:3	C1: HC, C2:		
WINNER				Total			

PTS

Decision of Superiority

Judge 1	Judge 2	Judge 3	Judge 4	Judge 5	Judge 6	Judge 7	Referee

Name _____

Signature _____

Lion Cup 2024 Luxembourg

297 Rue de Reckenthal L-2410 Strassen, LUXEMBOURG

Court Nr.	1	Pool	1	Date	2024-06-08	Field Position	61
RED				BLUE			
NOC	PICAZO LUQUE ANGEL (FRA)			NOC	LANG MARCUS (AUT)		
Category	Kumite Male U21 - 60kg						
3 Points	2 Points	1 Point	Score	1 Point	2 Points	3 Points	
			:				
Penatlity				Penatlity			
			Total				

Decision of Superiority

Judge 1	Judge 2	Judge 3	Judge 4	Judge 5	Judge 6	Judge 7	Referee

Name _____

Signature _____

Lion Cup 2024 Luxembourg

297 Rue de Reckenthal L-2410 Strassen, LUXEMBOURG

Court Nr.	1	Pool	1	Date	2024-06-08	Field Position	63
RED				BLUE			
NOC	LANG MARCUS (AUT)			NOC	COIMBRA POL (LUX)		
Category	Kumite Male U21 - 60kg						
3 Points	2 Points	1 Point	Score	1 Point	2 Points	3 Points	
			6 : 8				
Penatlity				Penatlity			
C1: , C2:			6:8	C1: C3, C2:			
			Total	WINNER			

PTS

Decision of Superiority



Judge 1	Judge 2	Judge 3	Judge 4	Judge 5	Judge 6	Judge 7	Referee

Name _____

Signature _____

Lion Cup 2024 Luxembourg - 2024-06-07

Official Results

Kumite Male U21 - 60kg			
1	COIMBRA POL		LUX - LUXEMBOURG
2	LANG MARCUS		AUT - AUSTRIA
3	HANSEN HENRIK WALSTAD		NOR - NORWAY

KUMITE MALE U21 - 67KG

Lion Cup 2024 Luxembourg

ENTRIES BY WEIGHT CATEGORY
Kumite Male U21 - 67kg

As of 8 JUN 2024

NOC Code	Gender	Name	Seeding
BEL	M	Bouzahzah Isshak-Mohamed	
BEL	M	Ejja Amine	
BEL	M	Van Den Nieuwenhuijzen Leroy	
ENG	M	Monk Luke	
FRA	M	CHOUVIN Paul	
LUX	M	Almalh Mahmoud	
LUX	M	Kiesgen Jimmy	
NED	M	El Mourabit Rayan	
NED	M	Roubos Sean	
SUI	M	Jost Ruben	

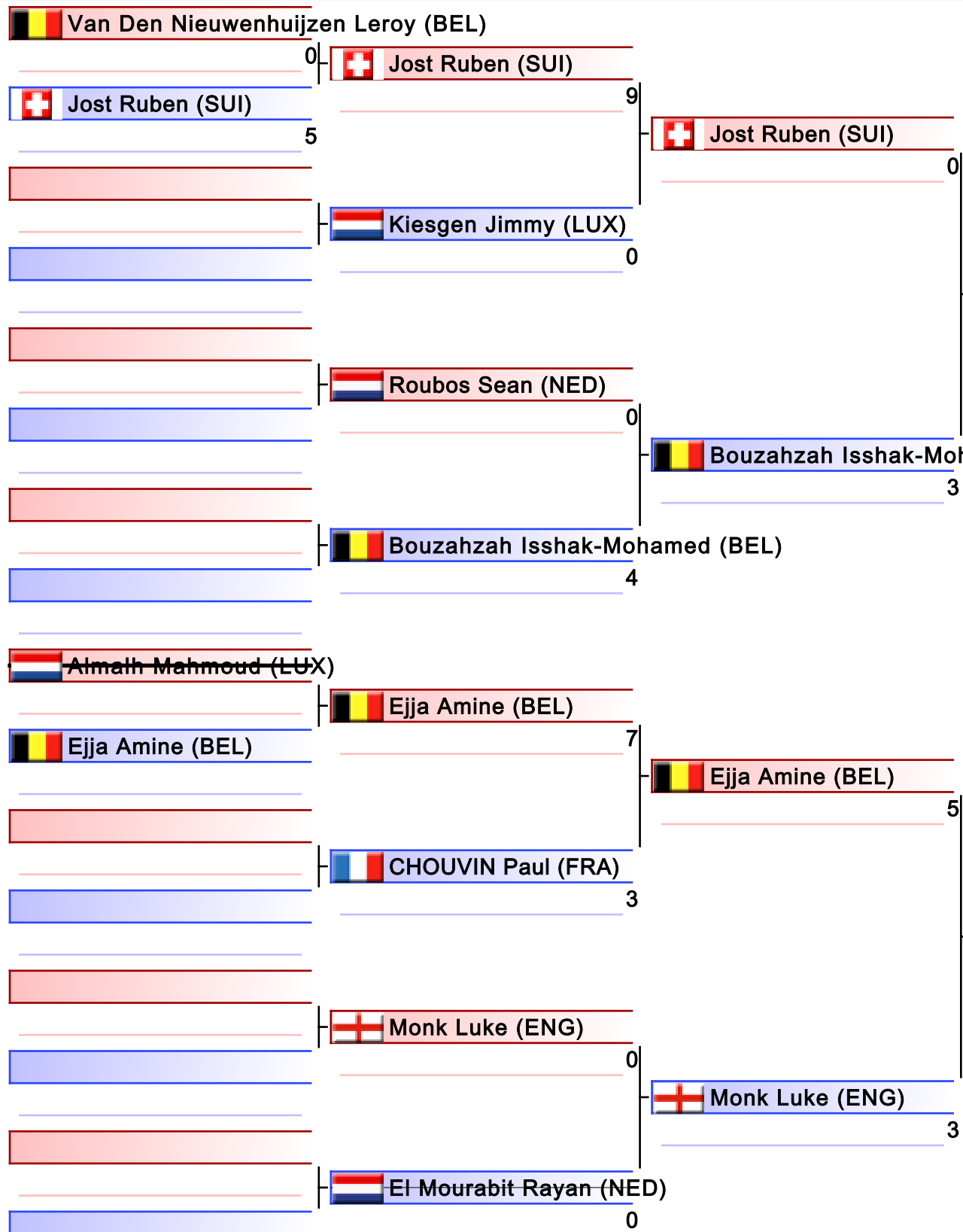

1. EJJA AMINE (BEL)
2. BOUZAHZAH ISSHAK-MOHAMED (BEL)
3. JOST RUBEN (SUI)
3. MONK LUKE (ENG)
5. ROUBOS SEAN (NED)
5. CHOUVIN PAUL (FRA)

Kumite Male U21 - 67kg

Lion Cup 2024 Luxembourg

2024-06-08

Tatami
2 12:20

Pool
1

(c)sportdata GmbH & Co KG 2000-2024 (2024-06-08 18:41) v 10.1.0 build 1 (2024-01-24 23:23 CET) License: Online_Event_ID-7672_LionCup2024Luxembourg (expire 2024-06-21)

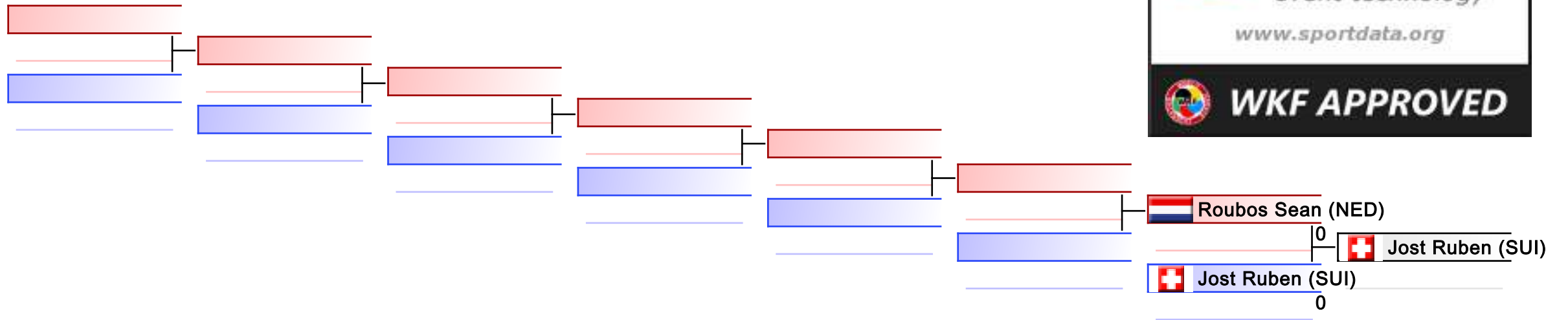

REPECHAGE: (1)

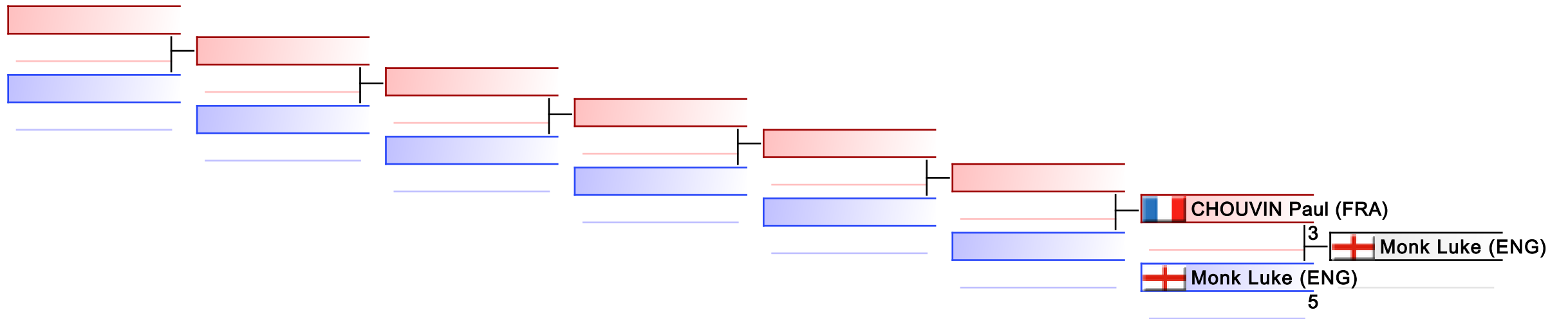

Lion Cup 2024 Luxembourg

297 Rue de Reckenthal L-2410 Strassen, LUXEMBOURG

Court Nr.	1	Pool	1	Date	2024-06-08	Field Position	49	
RED				BLUE				
NOC	VAN DEN NIEUWENHUIJZEN LEROY (BEL)			NOC	JOST RUBEN (SUI)			
Category	Kumite Male U21 - 67kg							
3 Points	2 Points	1 Point	Score	1 Point	2 Points	3 Points		
			0 : 5					
Penatlity				Penatlity				
C1: C3, C2:				0:5	C1: HC, C2:			
				Total	WINNER			

Decision of Superiority

Judge 1	Judge 2	Judge 3	Judge 4	Judge 5	Judge 6	Judge 7	Referee

Name _____

Signature _____

Lion Cup 2024 Luxembourg

297 Rue de Reckenthal L-2410 Strassen, LUXEMBOURG

Court Nr.	1	Pool	1	Date	2024-06-08	Field Position	57
RED				BLUE			
NOC	JOST RUBEN (SUI)			NOC	KIESGEN JIMMY (LUX)		
Category	Kumite Male U21 - 67kg						
3 Points	2 Points	1 Point	Score	1 Point	2 Points	3 Points	
			9 : 0				
Penatlity				Penatlity			
C1: C2, C2:				9:0	C1: , C2:		
WINNER				Total			

Decision of Superiority

Judge 1	Judge 2	Judge 3	Judge 4	Judge 5	Judge 6	Judge 7	Referee

Name _____

Signature _____

Lion Cup 2024 Luxembourg

297 Rue de Reckenthal L-2410 Strassen, LUXEMBOURG

Court Nr.	1	Pool	1	Date	2024-06-08	Field Position	58
RED				BLUE			
NOC	ROUBOS SEAN (NED)			NOC	BOUZHAAH ISSHAK-MOHAMED (BEL)		
Category	Kumite Male U21 - 67kg						
3 Points	2 Points	1 Point	Score	1 Point	2 Points	3 Points	
			0 : 4				
Penatlity				Penatlity			
C1: C1, C2:				0:4	C1: C1, C2:		
				Total	WINNER		

Decision of Superiority

Judge 1	Judge 2	Judge 3	Judge 4	Judge 5	Judge 6	Judge 7	Referee

Name _____

Signature _____

Lion Cup 2024 Luxembourg

297 Rue de Reckenthal L-2410 Strassen, LUXEMBOURG

Court Nr.	1	Pool	1	Date	2024-06-08	Field Position	59	
RED				BLUE				
NOC	EJJA AMINE (BEL)			NOC	CHOUVIN PAUL (FRA)			
Category	Kumite Male U21 - 67kg							
3 Points	2 Points	1 Point	Score	1 Point	2 Points	3 Points		
			7 : 3					
Penatlity				Penatlity				
C1: HC, C2:				7:3	C1: C3, C2:			
WINNER				Total				

Decision of Superiority

Judge 1	Judge 2	Judge 3	Judge 4	Judge 5	Judge 6	Judge 7	Referee

Name _____

Signature _____

Lion Cup 2024 Luxembourg

297 Rue de Reckenthal L-2410 Strassen, LUXEMBOURG

Court Nr.	1	Pool	1	Date	2024-06-08	Field Position	61
RED				BLUE			
NOC	JOST RUBEN (SUI)			NOC	BOUZHAAH ISSHAK-MOHAMED (BEL)		
Category	Kumite Male U21 - 67kg						
3 Points	2 Points	1 Point	Score	1 Point	2 Points	3 Points	
			0 : 3				
Penatlity				Penatlity			
C1: , C2:			0:3	C1: C3, C2:			
			Total	WINNER			

Decision of Superiority

Judge 1	Judge 2	Judge 3	Judge 4	Judge 5	Judge 6	Judge 7	Referee

Name _____

Signature _____

Lion Cup 2024 Luxembourg

297 Rue de Reckenthal L-2410 Strassen, LUXEMBOURG

Court Nr.	1	Pool	1	Date	2024-06-08	Field Position	62	
RED				BLUE				
NOC	EJJA AMINE (BEL)			NOC	MONK LUKE (ENG)			
Category	Kumite Male U21 - 67kg							
3 Points	2 Points	1 Point	Score	1 Point	2 Points	3 Points		
			5 : 3					
Penatlity				Penatlity				
C1: HC, C2:				5:3	C1: C2, C2:			
WINNER				Total				

Decision of Superiority

Judge 1	Judge 2	Judge 3	Judge 4	Judge 5	Judge 6	Judge 7	Referee

Name _____

Signature _____

Lion Cup 2024 Luxembourg

297 Rue de Reckenthal L-2410 Strassen, LUXEMBOURG

Court Nr.	1	Pool	1	Date	2024-06-08	Field Position	63	
RED				BLUE				
NOC	BOUZAHZAH ISSHAK-MOHAMED (BEL)			NOC	EJJA AMINE (BEL)			
Category	Kumite Male U21 - 67kg							
3 Points	2 Points	1 Point	Score	1 Point	2 Points	3 Points		
			2 : 4					
Penatlity				Penatlity				
C1: HC, C2:				2:4	C1: HC, C2:			
				Total	WINNER			

Decision of Superiority

Judge 1	Judge 2	Judge 3	Judge 4	Judge 5	Judge 6	Judge 7	Referee

Name _____

Signature _____

Lion Cup 2024 Luxembourg

297 Rue de Reckenthal L-2410 Strassen, LUXEMBOURG

Court Nr.	1	Pool	1	Date	2024-06-08	Field Position	0
RED				BLUE			
NOC	ROUBOS SEAN (NED)			NOC	JOST RUBEN (SUI)		
Category	Kumite Male U21 - 67kg						
3 Points	2 Points	1 Point	Score	1 Point	2 Points	3 Points	
			:				
Penatlity				Penatlity			
			Total				

Decision of Superiority

Judge 1	Judge 2	Judge 3	Judge 4	Judge 5	Judge 6	Judge 7	Referee

Name _____

Signature _____

Lion Cup 2024 Luxembourg

297 Rue de Reckenthal L-2410 Strassen, LUXEMBOURG

Court Nr.	2	Pool	2	Date	2024-06-08	Field Position	0	
RED				BLUE				
NOC	CHOUVIN PAUL (FRA)			NOC	MONK LUKE (ENG)			
Category	Kumite Male U21 - 67kg							
3 Points	2 Points	1 Point	Score	1 Point	2 Points	3 Points		
			3 : 5					
Penatlity				Penatlity				
C1: HC, C2:				3:5	C1: HC, C2:			
				Total	WINNER			

Decision of Superiority

Judge 1	Judge 2	Judge 3	Judge 4	Judge 5	Judge 6	Judge 7	Referee

Name _____

Signature _____

Official Results

Kumite Male U21 - 67kg			
1	EJJA AMINE		BEL - BELGIUM
2	BOUZAHZAH ISSHAK-MOHAMED		BEL - BELGIUM
3	JOST RUBEN		SUI - SWITZERLAND
3	MONK LUKE		ENG - ENGLAND
5	ROUBOS SEAN		NED - NETHERLANDS
5	CHOUVIN PAUL		FRA - FRANCE

KUMITE FEMALE U14 - 42KG

Lion Cup 2024 Luxembourg

ENTRIES BY WEIGHT CATEGORY
Kumite female U14 - 42kg

As of 8 JUN 2024

NOC Code	Gender	Name	Seeding
ALG	F	MOUGHARI IBTIHAL TAKOUA	
EGY	F	Gaballa Rama	
GER	F	Altenhof Mira	
GER	F	Baumgärtner Lara	
LUX	F	Cornet Maxine	
LUX	F	Kuborn Lily	
LUX	F	Nakano Mathilde	
NED	F	Bohoudi Inssaf	
NED	F	Kong Faith	
NED	F	Lu Jaimi	
NOR	F	Hansen Celine Marie Walstad	
POL	F	Grzakowska Klaudia	
SUI	F	Kanesan Alycia	
SUI	F	Steiner Solène	
SUI	F	VERGA Ludivine	
SUI	F	Widmer Alisha	

Kumite female U14 - 42kg

Lion Cup 2024 Luxembourg

2024-06-08

Tatami
2 15:15

Pool
1

(c)sportdata GmbH & Co KG 2000-2024 (2024-06-08 18:41) v 10.1.0 build 1 (2024-01-24 23:23 CET) License: Online_Event_ID-7672_LionCup2024Luxembourg (expire 2024-06-21)

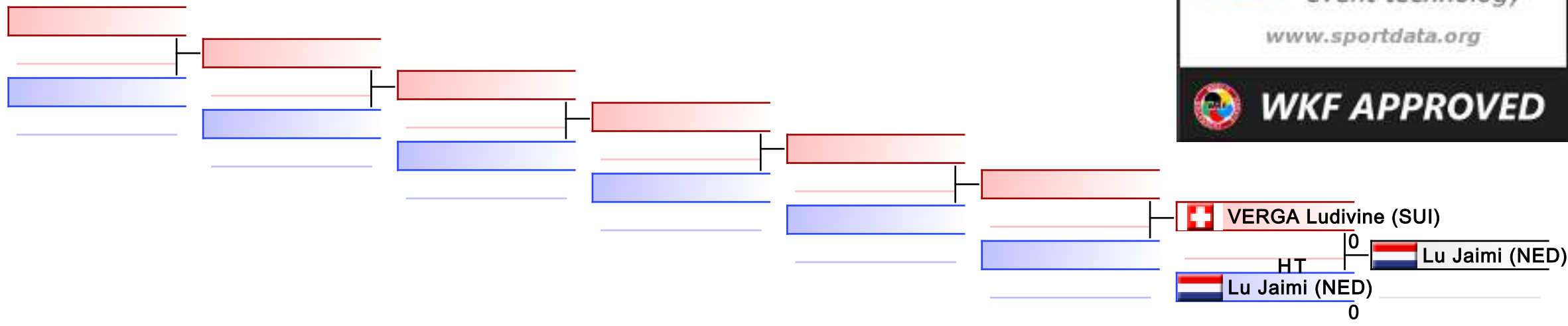

REPECHAGE: (1)

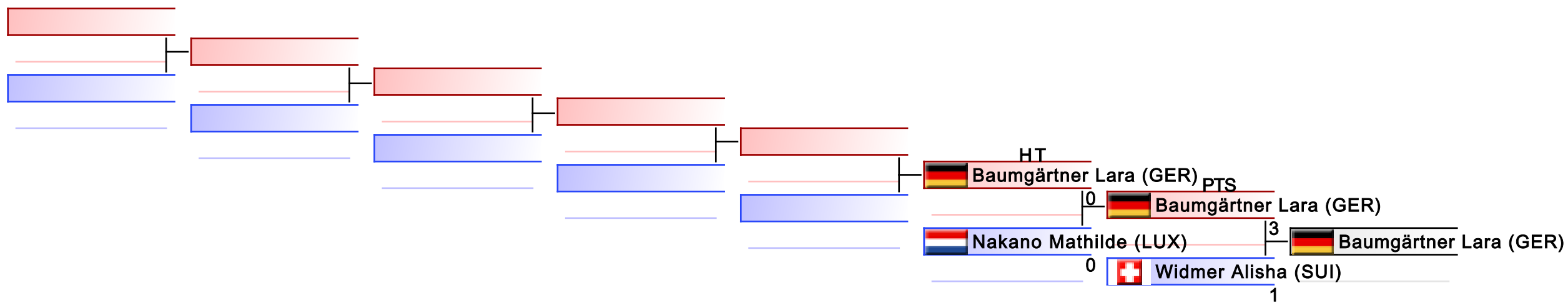

Lion Cup 2024 Luxembourg

297 Rue de Reckenthal L-2410 Strassen, LUXEMBOURG

Court Nr.	1	Pool	1	Date	2024-06-08	Field Position	49	
RED				BLUE				
NOC	LU JAIMI (NED)			NOC	STEINER SOLNE (SUI)			
Category	Kumite female U14 - 42kg							
3 Points	2 Points	1 Point	Score	1 Point	2 Points	3 Points		
			4 : 2					
Penatlity				Penatlity				
C1: HC, C2:				4:2	C1: C1, C2:			
WINNER				Total				

PTS

Decision of Superiority

Judge 1	Judge 2	Judge 3	Judge 4	Judge 5	Judge 6	Judge 7	Referee

Name _____

Signature _____

Lion Cup 2024 Luxembourg

297 Rue de Reckenthal L-2410 Strassen, LUXEMBOURG

Court Nr.	1	Pool	1	Date	2024-06-08	Field Position	50
RED				BLUE			
NOC	HANSEN CELINE MARIE WALSTAD (NOR)			NOC	KUBORN LILY (LUX)		
Category	Kumite female U14 - 42kg						
3 Points	2 Points	1 Point	Score	1 Point	2 Points	3 Points	
			2 : 0				
Penatlity				Penatlity			
C1: , C2:				2:0	C1: , C2:		
WINNER				Total			

PTS

Decision of Superiority

Judge 1	Judge 2	Judge 3	Judge 4	Judge 5	Judge 6	Judge 7	Referee

Name _____

Signature _____

Lion Cup 2024 Luxembourg

297 Rue de Reckenthal L-2410 Strassen, LUXEMBOURG

Court Nr.	1	Pool	1	Date	2024-06-08	Field Position	54
RED				BLUE			
NOC	KANESAN ALYCIA (SUI)			NOC	BAUMGRTNER LARA (GER)		
Category	Kumite female U14 - 42kg						
3 Points	2 Points	1 Point	Score	1 Point	2 Points	3 Points	
			4 : 1				
Penatlity					Penatlity		
C1: C1, C2:				4:1	C1: C1, C2:		
WINNER				Total			

PTS

Decision of Superiority

Judge 1	Judge 2	Judge 3	Judge 4	Judge 5	Judge 6	Judge 7	Referee

Name _____

Signature _____

Lion Cup 2024 Luxembourg

297 Rue de Reckenthal L-2410 Strassen, LUXEMBOURG

Court Nr.	1	Pool	1	Date	2024-06-08	Field Position	55
RED				BLUE			
NOC	BOHOUDI INSSAF (NED)			NOC	CORNET MAXINE (LUX)		
Category	Kumite female U14 - 42kg						
3 Points	2 Points	1 Point	Score	1 Point	2 Points	3 Points	
			0 : 0				
Penatlity				Penatlity			
C1: HC, C2:			0:0	C1: HC, C2:			
WINNER			Total				

HT

Decision of Superiority

Judge 1	Judge 2	Judge 3	Judge 4	Judge 5	Judge 6	Judge 7	Referee

Name _____

Signature _____

Lion Cup 2024 Luxembourg

297 Rue de Reckenthal L-2410 Strassen, LUXEMBOURG

Court Nr.	1	Pool	1	Date	2024-06-08	Field Position	56	
RED				BLUE				
NOC	KONG FAITH (NED)			NOC	WIDMER ALISHA (SUI)			
Category	Kumite female U14 - 42kg							
3 Points	2 Points	1 Point	Score	1 Point	2 Points	3 Points		
			0 : 2					
Penatlity				Penatlity				
C1: , C2:				0:2	C1: HC, C2:			
				Total	WINNER			

PTS

Decision of Superiority

Judge 1	Judge 2	Judge 3	Judge 4	Judge 5	Judge 6	Judge 7	Referee

Name _____

Signature _____

Lion Cup 2024 Luxembourg

297 Rue de Reckenthal L-2410 Strassen, LUXEMBOURG

Court Nr.	1	Pool	1	Date	2024-06-08	Field Position	57
RED				BLUE			
NOC	LU JAIMI (NED)			NOC	HANSEN CELINE MARIE WALSTAD (NOR)		
Category	Kumite female U14 - 42kg						
3 Points	2 Points	1 Point	Score	1 Point	2 Points	3 Points	
			2 : 0				
Penatlity				Penatlity			
C1: , C2:				2:0	C1: , C2:		
WINNER				Total			

PTS

Decision of Superiority

Judge 1	Judge 2	Judge 3	Judge 4	Judge 5	Judge 6	Judge 7	Referee

Name _____

Signature _____

Lion Cup 2024 Luxembourg

297 Rue de Reckenthal L-2410 Strassen, LUXEMBOURG

Court Nr.	1	Pool	1	Date	2024-06-08	Field Position	58
RED				BLUE			
NOC	VERGA LUDIVINE (SUI)			NOC	ALTENHOF MIRA (GER)		
Category	Kumite female U14 - 42kg						
3 Points	2 Points	1 Point	Score	1 Point	2 Points	3 Points	
			0 : 1				
Penatlity					Penatlity		
C1: , C2:				0:1	C1: , C2:		
				Total	WINNER		

PTS

Decision of Superiority

Judge 1	Judge 2	Judge 3	Judge 4	Judge 5	Judge 6	Judge 7	Referee

Name _____

Signature _____

Lion Cup 2024 Luxembourg

297 Rue de Reckenthal L-2410 Strassen, LUXEMBOURG

Court Nr.	1	Pool	1	Date	2024-06-08	Field Position	59
RED				BLUE			
NOC	NAKANO MATHILDE (LUX)			NOC	KANESAN ALYCIA (SUI)		
Category	Kumite female U14 - 42kg						
3 Points	2 Points	1 Point	Score	1 Point	2 Points	3 Points	
			0 : 6				
Penatlity				Penatlity			
C1: , C2:				0:6	C1: , C2:		
				Total	WINNER		

PTS

Decision of Superiority

Judge 1	Judge 2	Judge 3	Judge 4	Judge 5	Judge 6	Judge 7	Referee

Name _____

Signature _____

Lion Cup 2024 Luxembourg

297 Rue de Reckenthal L-2410 Strassen, LUXEMBOURG

Court Nr.	1	Pool	1	Date	2024-06-08	Field Position	60
RED				BLUE			
NOC	BOHOUDI INSSAF (NED)			NOC	WIDMER ALISHA (SUI)		
Category	Kumite female U14 - 42kg						
3 Points	2 Points	1 Point	Score	1 Point	2 Points	3 Points	
			0 : 3				
Penatlity				Penatlity			
C1: C3, C2:				0:3	C1: , C2:		
				Total	WINNER		

PTS

Decision of Superiority

Judge 1	Judge 2	Judge 3	Judge 4	Judge 5	Judge 6	Judge 7	Referee

Name _____

Signature _____

Lion Cup 2024 Luxembourg

297 Rue de Reckenthal L-2410 Strassen, LUXEMBOURG

Court Nr.	1	Pool	1	Date	2024-06-08	Field Position	61	
RED				BLUE				
NOC	LU JAIMI (NED)			NOC	ALTENHOF MIRA (GER)			
Category	Kumite female U14 - 42kg							
3 Points	2 Points	1 Point	Score	1 Point	2 Points	3 Points		
			0 : 7					
Penatlity				Penatlity				
C1: C1, C2:				0:7	C1: C1, C2:			
				Total	WINNER			

PTS

Decision of Superiority

Judge 1	Judge 2	Judge 3	Judge 4	Judge 5	Judge 6	Judge 7	Referee

Name _____

Signature _____

Lion Cup 2024 Luxembourg

297 Rue de Reckenthal L-2410 Strassen, LUXEMBOURG

Court Nr.	1	Pool	1	Date	2024-06-08	Field Position	62
RED				BLUE			
NOC	KANESAN ALYCIA (SUI)			NOC	WIDMER ALISHA (SUI)		
Category	Kumite female U14 - 42kg						
3 Points	2 Points	1 Point	Score	1 Point	2 Points	3 Points	
			4 : 0				
Penatlity				Penatlity			
C1: C1, C2:			4:0	C1: C2, C2:			
WINNER			Total				

PTS

Decision of Superiority

Judge 1	Judge 2	Judge 3	Judge 4	Judge 5	Judge 6	Judge 7	Referee

Name _____

Signature _____

Lion Cup 2024 Luxembourg

297 Rue de Reckenthal L-2410 Strassen, LUXEMBOURG

Court Nr.	1	Pool	1	Date	2024-06-08	Field Position	63
RED				BLUE			
NOC	ALTENHOF MIRA (GER)			NOC	KANESAN ALYCIA (SUI)		
Category	Kumite female U14 - 42kg						
3 Points	2 Points	1 Point	Score	1 Point	2 Points	3 Points	
			10 : 0				
Penatlity				Penatlity			
C1: C1, C2:			10:0	C1: , C2:			
WINNER			Total				

PTS

Decision of Superiority

Judge 1	Judge 2	Judge 3	Judge 4	Judge 5	Judge 6	Judge 7	Referee

Name _____

Signature _____

Lion Cup 2024 Luxembourg

297 Rue de Reckenthal L-2410 Strassen, LUXEMBOURG

Court Nr.	1	Pool	1	Date	2024-06-08	Field Position	0
RED				BLUE			
NOC	VERGA LUDIVINE (SUI)			NOC	LU JAIMI (NED)		
Category	Kumite female U14 - 42kg						
3 Points	2 Points	1 Point	Score	1 Point	2 Points	3 Points	
			:				
Penatlity				Penatlity			
			Total				

Decision of Superiority

Judge 1	Judge 2	Judge 3	Judge 4	Judge 5	Judge 6	Judge 7	Referee

Name _____

Signature _____

Lion Cup 2024 Luxembourg

297 Rue de Reckenthal L-2410 Strassen, LUXEMBOURG

Court Nr.	2	Pool	2	Date	2024-06-08	Field Position	0
RED				BLUE			
NOC	BAUMGRTNER LARA (GER)			NOC	WIDMER ALISHA (SUI)		
Category	Kumite female U14 - 42kg						
3 Points	2 Points	1 Point	Score	1 Point	2 Points	3 Points	
			3 : 1				
Penatlity					Penatlity		
C1: HC, C2:				3:1	C1: , C2:		
WINNER				Total			

PTS

Decision of Superiority

Judge 1	Judge 2	Judge 3	Judge 4	Judge 5	Judge 6	Judge 7	Referee

Name _____

Signature _____

Lion Cup 2024 Luxembourg

297 Rue de Reckenthal L-2410 Strassen, LUXEMBOURG

Court Nr.	2	Pool	2	Date	2024-06-08	Field Position	2
RED				BLUE			
NOC	BAUMGRTNER LARA (GER)			NOC	NAKANO MATHILDE (LUX)		
Category	Kumite female U14 - 42kg						
3 Points	2 Points	1 Point	Score	1 Point	2 Points	3 Points	
			0 : 0				
Penatlity				Penatlity			
C1: , C2:				0:0	C1: , C2:		
WINNER				Total			

HT

Decision of Superiority

Judge 1	Judge 2	Judge 3	Judge 4	Judge 5	Judge 6	Judge 7	Referee

Name _____

Signature _____



Lion Cup 2024 Luxembourg - 2024-06-07

Official Results



Kumite female U14 - 42kg			
1	ALTENHOF MIRA		GER - GERMANY
2	KANESAN ALYCIA		SUI - SWITZERLAND
3	LU JAIMI		NED - NETHERLANDS
3	BAUMGÄRTNER LARA		GER - GERMANY
5	VERGA LUDIVINE		SUI - SWITZERLAND
5	WIDMER ALISHA		SUI - SWITZERLAND
7	NAKANO MATHILDE		LUX - LUXEMBOURG

Official Results

06 - Kata Female U14					
1	SCHEDEL KAENA	EKTS LAUSANNE VUFFLENS		SUI - SWITZERLAND	
2	WEISS TIFFANY	SWISS KARATE UNION		SUI - SWITZERLAND	
3	CEDOLIN CLARA	SPORTING KARATÉ BUDO ELITE		FRA - FRANCE	
3	SIGILLÒ ANASTASIA	SWISS KARATE UNION		SUI - SWITZERLAND	
5	MICHAUD ZOË	SWISS KARATE UNION		SUI - SWITZERLAND	
5	COSTA NURIA	KARATE CLUB LINTGEN		LUX - LUXEMBOURG	
7	ELS NOËMIE	KC WALFER		LUX - LUXEMBOURG	
7	BALDEON AMAZONA	KC WALFER		LUX - LUXEMBOURG	

07 - Kata Female U16					
1	VORATOVIC ILIANA	SPORTING KARATÉ BUDO ELITE		FRA - FRANCE	
2	BREISCH ANNA	KARATE CLUB LINTGEN		LUX - LUXEMBOURG	
3	JOHANNIS CAMILLE	KARATE CLUB LINTGEN		LUX - LUXEMBOURG	
3	SFIHI INÈS	KARATE CLUB DE CHARENTON - SAINT- MAURICE		FRA - FRANCE	
5	COQUILLARD ELISE	KC WALFER		LUX - LUXEMBOURG	
5	CAMPELL LARISSA	SWISS KARATE UNION		SUI - SWITZERLAND	
7	MONNIER CASSANDRA	SWISS KARATE UNION		SUI - SWITZERLAND	
7	NAKANO LEA	KARATE MJC YUTZ		FRA - FRANCE	









08 - Kata Female U18					
1	RITZ LILA	KARATE EMME		SUI - SWITZERLAND	
2	DRUJON MAELLE	SPORTING KARATÉ BUDO ELITE		FRA - FRANCE	
3	MANCA GIULIA	KARATE CLUB 31		BEL - BELGIUM	
3	VORATOVIC ILIANA	SPORTING KARATÉ BUDO ELITE		FRA - FRANCE	
5	RODRIGO SARAH	KARATE CLUB LINTGEN		LUX - LUXEMBOURG	
5	MILER GELSEY	BUSHIDO KARATE TEAM		BEL - BELGIUM	
7	GUILLAUME CASSANDRE	SPORTING KARATÉ BUDO ELITE		FRA - FRANCE	
7	DELAY SARA	SWISS KARATE UNION		SUI - SWITZERLAND	

09 - Kata Female U21					
1	LEITAO ROMANE	SPORTING KARATÉ BUDO ELITE		FRA - FRANCE	
2	WU LISA	KARATE-DO BUITENVELDERT		NED - NETHERLANDS	
3	STEENHUIJSEN EVA	KARATE-DO BUITENVELDERT		NED - NETHERLANDS	

Official Results

3	DRUJON LUCILLE	SPORTING KARATÉ BUDO ELITE		FRA - FRANCE	
5	SCUFLAIRE EMMA	KARATÉ CLUB BAUDOUR ASBL		BEL - BELGIUM	
5	ZAYED FATIMA	SWISS KARATE UNION		SUI - SWITZERLAND	

11 - Kata Female Senior

1	RITZ LILA	KARATE EMME		SUI - SWITZERLAND	
2	LEITAO ROMANE	SPORTING KARATÉ BUDO ELITE		FRA - FRANCE	
3	WU LISA	KARATE-DO BUITENVELDERT		NED - NETHERLANDS	
3	SÖKARE FELICIA	TUREBERGS KARATEKLUBB		SWE - SWEDEN	
5	DRUJON MAELLE	SPORTING KARATÉ BUDO ELITE		FRA - FRANCE	
5	DRUJON LUCILLE	SPORTING KARATÉ BUDO ELITE		FRA - FRANCE	
7	EISELT ZOE	SWISS KARATE UNION		SUI - SWITZERLAND	
7	MILER GELSEY	BUSHIDO KARATE TEAM		BEL - BELGIUM	
9	SCUFLAIRE EMMA	KARATÉ CLUB BAUDOUR ASBL		BEL - BELGIUM	

17 - Kata Male U14

1	NGUYEN ERVIN	KARATE CLUB DE VILLEPINTE ET OMNISPORTS		FRA - FRANCE	
2	DONGHIA ALESSIO	A.A.S.S. KARATE SARCELLES		FRA - FRANCE	
3	DERNONCOURT SOFIANE	ACADÉMIE KARATÉ LEPONCE		BEL - BELGIUM	
3	DEGÉE LOUIS	KARATE CLUB ANDENNE-SEILLES		BEL - BELGIUM	
5	LIMACHER RAMON	SWISS KARATE UNION		SUI - SWITZERLAND	
5	HART ENOHA	CLUB OMNI SPORT DE VILLERS-LÈS- NANCY		FRA - FRANCE	
7	JESUS PEREIRA MATIAS	KARATE CLUB DIFFERDANGE		LUX - LUXEMBOURG	
7	PAN JAXON	KARATE CLUB DIFFERDANGE		LUX - LUXEMBOURG	

18 - Kata Male U16

1	NGUYEN THYLANE	KARATE CLUB DE VILLEPINTE ET OMNISPORTS		FRA - FRANCE	
2	GILLES BOSCHMANS	KARATECLUB KACHI NINOVE		BEL - BELGIUM	
3	FRANCAIS KILLIAN	SHOTOKAN KARATÉ CLUB VERDUN		FRA - FRANCE	
3	LÜTHY CORSIN DION	KARATE DO BRUGG		SUI - SWITZERLAND	
5	MORRISON LOGAN	FJK-SCOTLAND		SCO - SCOTLAND	
5	DOS SANTOS SAMUEL	SWISS KARATE UNION		SUI - SWITZERLAND	

Official Results

7	MARREDA-LE-MAIGNENT SASHA	KARATÉ CLUB BAUDOUR ASBL		BEL - BELGIUM	
7	SOARES GONÇALO	KAMIGAITO WADO RYU KARATE MAMER		LUX - LUXEMBOURG	

19 - Kata Male U18

1	BRUSCELLA SAMUELE	KAMIGAITO WADO RYU KARATE MAMER		LUX - LUXEMBOURG	
2	D ONGHIA ENZO	A.A.S.S. KARATE SARCELLES		FRA - FRANCE	
3	VAN DER HEIJDEN LUCA	KARATESCHOOL BU SHIN KAN		NED - NETHERLANDS	
3	BAGDJA BENAYA	KARATE TEAM SONNEMA		NED - NETHERLANDS	
5	OTT SIMON	KENSEIKAN KARATE- DO THUN		SUI - SWITZERLAND	
5	CAJÖRI MILO	SWISS KARATE UNION		SUI - SWITZERLAND	
7	AFONSO MARQUES LEANDRO	KARATE CLUB SUESSEM		LUX - LUXEMBOURG	
7	LOUIS ANTONIN	KARATE CLUB DE CHARENTON - SAINT- MAURICE		FRA - FRANCE	

20 - Kata Male U21

1	CHAFFORT LUCAS	KARATE CLUB STRASSEN		LUX - LUXEMBOURG	
2	GREGOIRE LIAM	SPORTING KARATÉ BUDO ELITE		FRA - FRANCE	
3	SCHEDER KENI	EKTS LAUSANNE VUFFLENS		SUI - SWITZERLAND	
3	SCHERTENLEIB LARS	GOJU KAN BERN		SUI - SWITZERLAND	

22 - Kata Male Senior

1	STASSIAUX MAHEL	A.A.S.S. KARATE SARCELLES		FRA - FRANCE	
2	DUCHAIINE GREGOIRE	A.A.S.S. KARATE SARCELLES		FRA - FRANCE	
3	GREGOIRE LIAM	SPORTING KARATÉ BUDO ELITE		FRA - FRANCE	
3	CHAFFORT LUCAS	KARATE CLUB STRASSEN		LUX - LUXEMBOURG	
5	BRUSCELLA SAMUELE	KAMIGAITO WADO RYU KARATE MAMER		LUX - LUXEMBOURG	
5	D ONGHIA ENZO	A.A.S.S. KARATE SARCELLES		FRA - FRANCE	
7	PETRY KEVIN	KARATE CLUB LINTGEN		LUX - LUXEMBOURG	
7	AFONSO MARQUES LEANDRO	KARATE CLUB SUESSEM		LUX - LUXEMBOURG	

KUMITE FEMALE U12 -30KG

1	SATTER SARA	KV NORDHORN		GER - GERMANY	
2	SATTER ANNA	KV NORDHORN		GER - GERMANY	
3	MOENS ADELE	KARATE CLUB STRASSEN		LUX - LUXEMBOURG	
3	DE WILDE NOA	VORIS KARATE SCHOTEN		BEL - BELGIUM	

Lion Cup 2024 Luxembourg - 2024-06-07

Official Results

5	SCHWERZMANN MONA	SHINSEI KAN LENZBURG		SUI - SWITZERLAND	
5	PAROIS ALLEGRA	KC WALFER		LUX - LUXEMBOURG	
7	VANAUDENHOVE VICTORIA	KC WALFER		LUX - LUXEMBOURG	
7	COMPAGNON SALSABILE	CHARDON		BEL - BELGIUM	

KUMITE FEMALE U14 +52KG

1	PIERANTONI NORA	KARATÉ CLUB NIEDERANVEN		LUX - LUXEMBOURG	
2	PAULUS CHAYENNE	SHOTOKAN - KARATE SAARWELLINGEN E.V.		GER - GERMANY	
3	GEYIKPINAR MELISSA	KARATE-DO LONGWY		FRA - FRANCE	
3	LEURS LILY	KARATEKENAMJU HAARLEM		NED - NETHERLANDS	
5	TIEFENAUER LENA	SSKF KARATE TEAM		SUI - SWITZERLAND	
5	BOUHNA ASSIYA	CHARDON		BEL - BELGIUM	

KUMITE FEMALE U14 -47KG

1	VLIELAND KAYLEIGH	UNITY99		NED - NETHERLANDS	
2	BELABASS ZINEB	KARATE CLUB STRASSEN		LUX - LUXEMBOURG	
3	NAF SYLVIE	KARATECENTER RETO KERN KREUZLINGEN		SUI - SWITZERLAND	
3	GUETARI YAKIN	SHINOBI KARATÉ CLUB		BEL - BELGIUM	
5	KESSEL ALEXIA	KARATE CLUB DIFFERDANGE		LUX - LUXEMBOURG	
5	INTINI RAFFAELLI LARA	KC WALFER		LUX - LUXEMBOURG	
7	KURTALIC SHERAZAD	KARATE CLUB BOSNA LIÈGE		BEL - BELGIUM	
7	GNĀGI NAYA	KARATEDO LYSS- AARBERG		SUI - SWITZERLAND	







KUMITE FEMALE U14 -52KG

1	POSKIN EMILIE	KARATE CLUB ANDENNE-SEILLES		BEL - BELGIUM	
2	VAN BOMMEL ISE	BVL FIGHTING		NED - NETHERLANDS	
3	BECKER CELINE	SHOTOKAN - KARATE SAARWELLINGEN E.V.		GER - GERMANY	
3	ROSA MAELYS	KARATE CLUB STRASSEN		LUX - LUXEMBOURG	
5	DURRER NAHIMA	KC WALFER		LUX - LUXEMBOURG	
5	KEULEN VAN NORAH	KARATEKENAMJU HAARLEM		NED - NETHERLANDS	
7	MOHAMMAD ROUHAIV	KV NORDHORN		GER - GERMANY	







KUMITE FEMALE U18 +66kg





1	ZWANENBURG ROBIN	UNITY99		NED - NETHERLANDS	
2	HOUT VAN LIZ	KARATEKENAMJU HAARLEM		NED - NETHERLANDS	

Official Results

KUMITE FEMALE U18 -66KG				
1	VALK IMANE	KARATESCHOOL FIGHTIN NABIL		NED - NETHERLANDS
2	KIROV VANESSA	SPORTSKARATE.FI		FIN - FINLAND
3	THEISEN MONIQUE	KARATE CLUB STRASSEN		LUX - LUXEMBOURG
3	JAKESEVIC IVANA	GYMNASTIK OCH ATLETKLUBBEN ENIGHET		SWE - SWEDEN
5	CALUORI SVENJA	KARATE DO BRUGG		SUI - SWITZERLAND
5	STAUB NIA	KARATESCHULE SURSEE		SUI - SWITZERLAND

KUMITE MALE U14 -45kg_				
1	PESCHIER KYANU	BUDOSCHOOL KAI SEI		NED - NETHERLANDS
2	YILDIRM ALI	KARATE CLUB STRASSEN		LUX - LUXEMBOURG
3	ENTHOVEN SCOTT	KARATEKENAMJU HAARLEM		NED - NETHERLANDS
3	ESSERS REINIER	KARATESCHOOL ALKEN		NED - NETHERLANDS
5	WERNER RUBEN	BUDOSCHOOL KAI SEI		NED - NETHERLANDS
5	ES-SALEHY ISMAIL	KARATE CLUB WINNERS		BEL - BELGIUM
7	STIRBU DAVID	YAMATSUKI-KARATÉ BRUXELLES		BEL - BELGIUM
7	BATTISTEL FLORIN	KARATEDO LYSS-AARBERG		SUI - SWITZERLAND

Kumite Female Senior +68kg				
1	ROSE NOLET LILY	QUIRICI2020		SUI - SWITZERLAND
2	TELLES JENNA	CHOKU-ZAANDAM		NED - NETHERLANDS
3	VAN WEZEL ROBIN	KARATESCHOOL FIGHTIN NABIL		NED - NETHERLANDS
3	KAUFMANN FABIENNE	KARATESCHULE SURSEE		SUI - SWITZERLAND
5	VOUTILAINEN SONJA	SPORTSKARATE.FI		FIN - FINLAND
5	BONNY SHANIA	SWISS KARATE UNION		SUI - SWITZERLAND

Kumite Female Senior -50kg				
1	HUBER LEA	KARATECENTER RETO KERN KREUZLINGEN		SUI - SWITZERLAND
2	BOUTRACIT AÏCHA	QUIRICI2020		SUI - SWITZERLAND
3	YALÇIN SAMINA	KARATESCHOOL FIGHTIN NABIL		NED - NETHERLANDS
3	BAS LOUSSINE	KARATE CLUB DE CHARENTON - SAINT-MAURICE		FRA - FRANCE

Kumite Female Senior -55 kg				
1	EJJA IMANE	CHAMPIONS CLUB		BEL - BELGIUM
2	VAN DEN BRAND JULIE	KARATE MOERDIJK		NED - NETHERLANDS

Official Results

3	RASMUSSEN MAJA KNØVL	SPORTSKARATE DRAMMEN		NOR - NORWAY	
3	GÖKTEKIN SIMLA	CHOKU-ZAANDAM		NED - NETHERLANDS	
5	NOBRE AMEIXA CYNTHIA	KARATE CLUB LINTGEN		LUX - LUXEMBOURG	
5	MONK ROSIE	EMPRISE ACADEMY		ENG - ENGLAND	

Kumite Female Senior -61kg

1	BOUGRINE AMEL	USLM KARATÉ MONT-SAINT-MARTIN		FRA - FRANCE	
2	QUIRICI MELIKA	QUIRICI2020		SUI - SWITZERLAND	
3	BOSSHARD LEA MARIE	KARATEDO LYSS- AARBERG		SUI - SWITZERLAND	
3	RADJENOVIC NINA	KARATEDO LYSS- AARBERG		SUI - SWITZERLAND	
5	HORSMANS JOANNA	CHOKU-ZAANDAM		NED - NETHERLANDS	
5	BURRI LILIANE	KARATEDO LYSS- AARBERG		SUI - SWITZERLAND	
7	LANDMAN MEREL	KARATE MOSSEL- BOOT		NED - NETHERLANDS	
7	LE MESTRE LARA	CHARDON		BEL - BELGIUM	

Kumite Female Senior -68kg

1	MAMADEUS SENNAH	KARATESCHOOL FIGHTIN NABIL		NED - NETHERLANDS	
2	BOUGRINE AMINA	USLM KARATÉ MONT-SAINT-MARTIN		FRA - FRANCE	
3	VERVOORT TESS	VORIS KARATE SCHOTEN		BEL - BELGIUM	
3	BOUGRINE NESRINE	USLM KARATÉ MONT-SAINT-MARTIN		FRA - FRANCE	
5	MIELKE NELE	KARATE DOJO DIETZENBACH		GER - GERMANY	

Kumite Female U12 +40kg

1	VAN DE VELDE ELHYA	CHAMPIONS CLUB		BEL - BELGIUM	
2	BOHOUDI AMANI	KARATESCHOOL FIGHTIN NABIL		NED - NETHERLANDS	
3	AREGGER LEILA	KARATESCHULE SURSEE		SUI - SWITZERLAND	
3	VEKEMANS LUANA	VORIS KARATE SCHOTEN		BEL - BELGIUM	
5	MANSOUR SONIA	YAMATSUKI-KARATÉ BRUXELLES		BEL - BELGIUM	
5	MAZZOLENI NAELYS	KARATE-DO LONGWY		FRA - FRANCE	







Kumite Female U12 -35kg

1	MAATOUG MERYAME	CHARDON		BEL - BELGIUM	
2	SERRA RODRIGUES INES	KARATÉ CLUB NIEDERANVEN		LUX - LUXEMBOURG	
3	MOENS ADELE	KARATE CLUB STRASSEN		LUX - LUXEMBOURG	
3	BOUTRACIT MARWA	QUIRICI2020		SUI - SWITZERLAND	
5	FONSECA LARA	CHINTO KAYL		LUX - LUXEMBOURG	

Official Results

Kumite Female U12 -40kg				
1	BAUMGÄRTNER LENA	TEAM FIGHTCLUB WESTERWALD		GER - GERMANY
2	RUSOVICI CATALINA	KARATE CLUB STRASSEN		LUX - LUXEMBOURG
3	PAYZINER ASYA	SSKF KARATE TEAM		SUI - SWITZERLAND
3	EL HOUDIFI ESMA	WAKAI TEAM		BEL - BELGIUM
5	KASHASH SHAM	KARATESCHOOL FIGHTIN NABIL		NED - NETHERLANDS
5	ZANOUN KEYLA	KARATE-DO LONGWY		FRA - FRANCE
7	CUSTODERO SARA	KARATE CLUB STRASSEN		LUX - LUXEMBOURG

Kumite Female U16 +61KG				
1	SRIDI MAISSA	ACADÉMIE KARATÉ LEPONCE		BEL - BELGIUM
2	VANROOY CHIARA	KC SAMOERAI LEUVEN		BEL - BELGIUM
3	REDZIC ESMA	SWISS KARATE UNION		SUI - SWITZERLAND
3	HOMRI TESNIME	KARATE CLUB DE CHARENTON - SAINT-MAURICE		FRA - FRANCE
5	BOHOUDI NADA	KARATESCHOOL FIGHTIN NABIL		NED - NETHERLANDS
5	OLAFSSON ELENA	KC WALFER		LUX - LUXEMBOURG









Kumite Female U16 - 61KG				
1	DE RUBEIS GIULIA	CHINTO KAYL		LUX - LUXEMBOURG
2	TAMBURRINI TITIA	ECOLE MARTIAL FIGHT PRO		BEL - BELGIUM
3	YORO EDEN	SPORTING KARATÉ BUDO ELITE		FRA - FRANCE
3	JONG DE ANNIEK	KARATEKENAMJU HAARLEM		NED - NETHERLANDS
5	GRES SARA	SHINSEI KAN LENZBURG		SUI - SWITZERLAND
5	GIBRIL HIBA	SSKF KARATE TEAM		SUI - SWITZERLAND
7	BOHOUDI MAYSSAN	KARATESCHOOL FIGHTIN NABIL		NED - NETHERLANDS
7	SEKETELI ELOISE	SPORTING KARATÉ BUDO ELITE		FRA - FRANCE

Kumite Female U16 -47kg				
1	MEZRAUI DOUNIA SOFIA	KARATE TEAM UTRECHT		NED - NETHERLANDS
2	ACHGHOUYAB LYNA	KARATESCHOOL FIGHTIN NABIL		NED - NETHERLANDS
3	LEPEZ DARLA	GEOFFREY BERENS KARATE ACADEMY		NED - NETHERLANDS
3	COQUILLARD ELISE	KC WALFER		LUX - LUXEMBOURG
5	GERBER YARA	KARATESCHULE SURSEE		SUI - SWITZERLAND
5	STREIT MILA CHIARA	KARATEDO LYSS-AARBERG		SUI - SWITZERLAND

Official Results

7	SELLAMI INSHIRAH	KARATESCHULE SURSEE		SUI - SWITZERLAND	
7	KIEFFER LYNN	CHINTO KAYL		LUX - LUXEMBOURG	

Kumite Female U16 -54kg

1	DUMITRAS PIA	SSKF KARATE TEAM		SUI - SWITZERLAND	
2	MULLER EVA	KARATE CLUB STRASSEN		LUX - LUXEMBOURG	
3	SANNEH FATUMATA	SSKF KARATE TEAM		SUI - SWITZERLAND	
3	TSCHARNER ANAIS	KARATEDO LYSS-AARBERG		SUI - SWITZERLAND	
5	GAUS ANJA	KARATEDO LYSS-AARBERG		SUI - SWITZERLAND	
5	PULVER MELINA	KARATEDO LYSS-AARBERG		SUI - SWITZERLAND	
7	TARCHI SABRINA	WAKAI TEAM		BEL - BELGIUM	
7	KOOP QUINTY	CHOKU-ZAANDAM		NED - NETHERLANDS	
9	THEISEN MARGOT	KARATE CLUB STRASSEN		LUX - LUXEMBOURG	

Kumite Female U18 -48kg

1	WYSSBROD SELIN	SWISS KARATE UNION		SUI - SWITZERLAND	
2	MOENS ALIX	KARATE CLUB STRASSEN		LUX - LUXEMBOURG	
3	SZABO MALNA	KC WALFER		LUX - LUXEMBOURG	

Kumite Female U18 -53kg

1	VOORDUIN ALYSSIA	UNITY99		NED - NETHERLANDS	
2	MARTINS DIAS GABRIELA	KARATE CLUB STRASSEN		LUX - LUXEMBOURG	
3	YUKSEKTEPE ASYA	CHAMPIONS CLUB		BEL - BELGIUM	
3	EL HOUDIFI ANISSA	WAKAI TEAM		BEL - BELGIUM	
5	PAUL-JACQUES JULINE	SWISS KARATE UNION		SUI - SWITZERLAND	





Kumite Female U18 -59kg

1	PICAZO LUQUE ELEONORE	A.A.S.S. KARATE SARCELLES		FRA - FRANCE	
2	AURÉLIE ANTOINE	CHARDON		BEL - BELGIUM	
3	MANSOUR DOUNYA	YAMATSUKI-KARATÉ BRUXELLES		BEL - BELGIUM	
3	MAATOUG NARGESSE	CHARDON		BEL - BELGIUM	
5	LEHNER LEONIE	LEISTUNGSZENTRUM WIEN		AUT - AUSTRIA	
5	KASHASH NOUR	KARATESCHOOL FIGHTIN NABIL		NED - NETHERLANDS	
7	STREIT KIM LARA	KARATEDO LYSS-AARBERG		SUI - SWITZERLAND	

Kumite Female U21 + 68kg

1	ROSE NOLET LILY	QUIRICI2020		SUI - SWITZERLAND	
2	TELLES JENNA	CHOKU-ZAANDAM		NED - NETHERLANDS	
3	BONNY SHANÍA	SWISS KARATE UNION		SUI - SWITZERLAND	

Official Results

Kumite Female U21 - 50kg				
1	BOUTRACIT AÏCHA	QUIRICI2020		SUI - SWITZERLAND
2	HUBER LEA	KARATECENTER RETO KERN KREUZLINGEN		SUI - SWITZERLAND
3	BEZRUK OLHA	KARATE CLUB DIFFERDANGE		LUX - LUXEMBOURG
3	MOENS ALIX	KARATE CLUB STRASSEN		LUX - LUXEMBOURG
5	BAS LOUSSINE	KARATE CLUB DE CHARENTON - SAINT- MAURICE		FRA - FRANCE

Kumite Female U21 - 55kg				
1	EJJA IMANE	CHAMPIONS CLUB		BEL - BELGIUM
2	GÖKTEKIN SIMLA	CHOKU-ZAANDAM		NED - NETHERLANDS
3	RASMUSSEN MAJA KNØVL	SPORTSKARATE DRAMMEN		NOR - NORWAY
3	VAN DEN BRAND JULIE	KARATE MOERDIJK		NED - NETHERLANDS

Kumite Female U21 - 61kg				
1	BOUGRINE AMEL	KARATE VLAANDEREN		BEL - BELGIUM
2	KAEBORISUT LYANA	UNITY99		NED - NETHERLANDS
3	BURRI LILIANE	KARATEDO LYSS- AARBERG		SUI - SWITZERLAND
3	BOSSHARD LEA MARIE	KARATEDO LYSS- AARBERG		SUI - SWITZERLAND
5	CARVALHO LARA	CKMAIA		POR - PORTUGAL

Kumite Female U21 - 68kg				
1	VERVOORT TESS	VORIS KARATE SCHOTEN		BEL - BELGIUM
2	MAMADEUS SENNAH	KARATESCHOOL FIGHTIN NABIL		NED - NETHERLANDS
3	BOUGRINE AMINA	KARATE VLAANDEREN		BEL - BELGIUM
3	SUURMOND ZOË	KARATE TEAM UTRECHT		NED - NETHERLANDS

Kumite Male Senior +84kg				
1	KABASHI JOHN	ELSON SPORT & KARATE		SUI - SWITZERLAND
2	MOERKERK VAN JOEL	KARATE MOSSEL- BOOT		NED - NETHERLANDS
3	PINTO BRUNO	CKMAIA		POR - PORTUGAL
3	PEREIRA LEONARDO	CENTRO BUDO DE FAFE		POR - PORTUGAL
5	ROUËCHE DAVID	SWISS KARATE UNION		SUI - SWITZERLAND
5	ZECCA DONATO	SWISS KARATE UNION		SUI - SWITZERLAND

Official Results

Kumite Male Senior -60kg				
1	DASOUL MICHAEL	KARATE VLAANDEREN		BEL - BELGIUM
2	TEIXEIRA TOMAS	KARATE CLUB STRASSEN		LUX - LUXEMBOURG
3	HANSEN HENRIK WALSTAD	SPORTSKARATE DRAMMEN		NOR - NORWAY
3	LANG MARCUS	LEISTUNGSZENTRUM WIEN		AUT - AUSTRIA
5	SERHANI ISLEM	SAMOURAI BETHIOUA		ALG - ALGERIA
5	LOPES IVAN	KARATE CLUB FUNAKOSHI		ESP - SPAIN

Kumite Male Senior -67kg				
1	MORINA FLORENT	KARATE- SPORT-CENTER FREUDENSTADT		GER - GERMANY
2	O'SULLIVAN CONOR	WSKF SENSHI		IRL - IRELAND
3	TAMIM YANIS	KARATE CLUB DIFFERDANGE		LUX - LUXEMBOURG
3	WALRABENSTEIN SEBASTIAN	SPORTSCHOOL VAN DEN NIEUWENDIJK		NED - NETHERLANDS
5	ACHARD BAPTISTE	USJC KARATE		FRA - FRANCE
5	JOST RUBEN	KARATEDO LYSS- AARBERG		SUI - SWITZERLAND
7	EL MOURABIT RAYAN	KARATESCHOOL FIGHTIN NABIL		NED - NETHERLANDS

Kumite Male Senior -75kg				
1	MOERKERK VAN DYLAN	KARATE MOSSEL- BOOT		NED - NETHERLANDS
2	VRANJES ANDREJ	KARATE DO BRUGG		SUI - SWITZERLAND
3	YUKSEKTEPE HAMZA	CHAMPIONS CLUB		BEL - BELGIUM
3	ROLAND TOM	KARATE CLUB 31		BEL - BELGIUM
5	GRIGORASENCO NICHITA	LZ OBERÖSTERREICH		AUT - AUSTRIA
5	PAUWELS LIEVEN	KARATE VLAANDEREN		BEL - BELGIUM
7	KELLY ANTHONY	I.K.K.U.		IRL - IRELAND
7	TERLICA GOMES SEBASTIEN	CHINTO KAYL		LUX - LUXEMBOURG
9	MASTARI SOUHAIL	KARATESCHOOL FIGHTIN NABIL		NED - NETHERLANDS

Kumite Male Senior -84kg				
1	OVERMAN JEAN-CLAUDE	UNITY99		NED - NETHERLANDS
2	DOBBERSTEIN LENNOX	KARATE DO BRUGG		SUI - SWITZERLAND
3	ABU KHALIL MOHAMMAD	KARATE VLAANDEREN		BEL - BELGIUM

Kumite Male U12 +45kg				
1	TASHCHUK OLEH	KC WALFER		LUX - LUXEMBOURG
2	PUPKUS LUKAS	KARATE CLUB STRASSEN		LUX - LUXEMBOURG
3	FERREIRA PERDIGAO RODRIGO	KARATE CLUB DIFFERDANGE		LUX - LUXEMBOURG

Lion Cup 2024 Luxembourg - 2024-06-07

Official Results

3	ZENDELI MERITON	SSKF KARATE TEAM		SUI - SWITZERLAND	
5	KAYA FATIH	CHOKU-ZAANDAM		NED - NETHERLANDS	

Kumite Male U12 -35kg

1	PALM LUCAS	ACADÉMIE KARATE NEUPRÉ		BEL - BELGIUM	
2	GEORGES JIM	KARATE CLUB STRASSEN		LUX - LUXEMBOURG	
3	SALMI ADAM YOUVA	USI KARATE		FRA - FRANCE	
3	BRUGNONI SACHA	KARATE CLUB STRASSEN		LUX - LUXEMBOURG	
5	QUARANTA SAVERIO	KARATÉ CLUB WALLONIE		BEL - BELGIUM	
5	HOWARD LONDON-JAMES	KHALSA KARATE ASSOCIATION		ENG - ENGLAND	
7	BACHIRI MEHDI	WAKAI TEAM		BEL - BELGIUM	
7	WERNER STIJN	BUDOSCHOOL KAI SEI		NED - NETHERLANDS	
9	VATAMANIUK ARTEM	KC WALFER		LUX - LUXEMBOURG	

Kumite Male U12 -45kg

1	GOTWALT JESAJA	KARATESCHOOL ALKEN		NED - NETHERLANDS	
2	BECKER TOM	SHOTOKAN - KARATE SAARWELLINGEN E.V.		GER - GERMANY	
3	TCHALDAEV ABDOUL	KARATE-DO LONGWY		FRA - FRANCE	
3	ANDERL LIONEL	LEISTUNGSZENTRUM WIEN		AUT - AUSTRIA	
5	NARCICEGI TAN	CHOKU-ZAANDAM		NED - NETHERLANDS	
5	DELIANIDIS IOANNIS	KARATESCHULE SURSEE		SUI - SWITZERLAND	
7	VOLDERS JOSHUA	KARATE MOERDIJK		NED - NETHERLANDS	
7	HACHEM ELIE	KARATÉ CLUB JAGUAR VALLORBE		SUI - SWITZERLAND	

Kumite Male U14 +50kg

1	BOHOUDI ILYAS	KARATESCHOOL FIGHTIN NABIL		NED - NETHERLANDS	
2	VAN DE NES DINAND	KARATESCHOOL FIGHTIN NABIL		NED - NETHERLANDS	
3	KNAROV AMBROISE	KARATE CLUB STRASSEN		LUX - LUXEMBOURG	
3	MEHADHEBI AMIR	YAMATSUKI-KARATÉ BRUXELLES		BEL - BELGIUM	
5	BERISHA DREN	SSKF KARATE TEAM		SUI - SWITZERLAND	
5	LEISTEDT OLIVER	KARATÉ CLUB BAUDOUR ASBL		BEL - BELGIUM	
7	GIESS THIERRY	SSKF KARATE TEAM		SUI - SWITZERLAND	





Kumite Male U14 -40kg

1	DERNONCOURT SOFIANE	ACADÉMIE KARATÉ LEPONCE		BEL - BELGIUM	
2	VUONG LEVIN	KARATEDO LYSS-AARBERG		SUI - SWITZERLAND	

Official Results

3	AZIBOUS YANIS	CHAMPIONS CLUB		BEL - BELGIUM	
3	BOSCOLO NATHAN	KARATÉ CLUB WALLONIE		BEL - BELGIUM	
5	GUETARI OUSSAMA	SHINOBI KARATÉ CLUB		BEL - BELGIUM	
5	ZAKHNINI IMRANE	ACADÉMIE KARATE BRUXELLES		BEL - BELGIUM	
7	RONDHUIS DEX	RENE SMAAL KARATE		NED - NETHERLANDS	
7	TARCHI SEDKI	WAKAI TEAM		BEL - BELGIUM	

Kumite Male U14 -50kg

1	MUSA LORIAN	KARATE CLUB VALAIS		SUI - SWITZERLAND	
2	STOUTJESDIJK AARON	UNITY99		NED - NETHERLANDS	
3	KAEWBORISUT AARON	UNITY99		NED - NETHERLANDS	
3	EL-AIDI OMAR	SHINOBI KARATÉ CLUB		BEL - BELGIUM	
5	MORINA ARTION	KARATE-SPORT-CENTER FREUDENSTADT		GER - GERMANY	
7	TIEFENAUER JONATHAN	SSKF KARATE TEAM		SUI - SWITZERLAND	
9	ALBU DAVID	KARATECLUB GOJU GEEL		BEL - BELGIUM	

Kumite Male U16 +70kg

1	EL JATTARI MOHAMMED AMINE	KARATESCHOOL FIGHTIN NABIL		NED - NETHERLANDS	
2	TWISK PATRICK	KARATEKENAMJU HAARLEM		NED - NETHERLANDS	
3	DE ROVER LUKE	SPORTSCHOOL MUILWIJK		NED - NETHERLANDS	
3	ZARCHID MONCEF	KARATESCHOOL FIGHTIN NABIL		NED - NETHERLANDS	
5	AMINE AZAHAF MOHAMED	KARATE CLUB WINNERS		BEL - BELGIUM	
5	LAZARIDIS PANAGIOTIS	KARATE CLUB WINNERS		BEL - BELGIUM	

Kumite Male U16 -52kg

1	ZECCA LUCAS	SWISS KARATE UNION		SUI - SWITZERLAND	
2	ABDELMAKI YOUSSEF	CHAMPIONS CLUB		BEL - BELGIUM	
3	ROLAND NATHAN	KARATÉ CLUB 31		BEL - BELGIUM	
3	SZEKERES MAXIM	KARATE CLUB STRASSEN		LUX - LUXEMBOURG	
5	LE MOIGNE YVAN	KC WALFER		LUX - LUXEMBOURG	
5	MATEUS GOMES CRISTIANO	KARATE DO BRUGG		SUI - SWITZERLAND	
7	ACKERBAUER SEBASTIAN ANDREAS	LZ OBERÖSTERREICH		AUT - AUSTRIA	
7	LU DARRICK	RENE SMAAL KARATE		NED - NETHERLANDS	
9	LÜTHY CORSIN DION	KARATE DO BRUGG		SUI - SWITZERLAND	
9	MESSAHEL WAEL ABDELKADER	ASSOCIATION SPORTIVE AMATEUR		ALG - ALGERIA	

Official Results

	AIN OUSSERA ALGÉRIE			
--	------------------------	--	--	--

Kumite Male U16 -57kg				
1	PERSAUD MAXIM	KARATEKENAMJU HAARLEM		NED - NETHERLANDS
2	HANSEN MARTIN WALSTAD	SPORTSKARATE DRAMMEN		NOR - NORWAY
3	SAEIJIS BENJAMIN	GEOFFREY BERENS KARATE ACADEMY		NED - NETHERLANDS
3	LEPEZ DEVON	GEOFFREY BERENS KARATE ACADEMY		NED - NETHERLANDS
5	SOLIARYK PLATON	SWISS KARATE UNION		SUI - SWITZERLAND
5	QUARANTA CALOGERO	KARATÉ CLUB WALLONIE		BEL - BELGIUM
7	AGOSTINO ENZO	KARATE CLUB DIFFERDANGE		LUX - LUXEMBOURG

Kumite Male U16 -63kg				
1	CHEBAN OLEKSANDR	LZ OBERÖSTERREICH		AUT - AUSTRIA
2	TODOROVIC FILIP	KARATÉ CLUB STRASSEN		LUX - LUXEMBOURG
3	ZOUEINI RAYAN	CHARDON		BEL - BELGIUM
3	SIEBER ELIJA	KARATECENTER RETO KERN KREUZLINGEN		SUI - SWITZERLAND
5	PONCET ARTHUR	KARATÉ CLUB JAGUAR VALLORBE		SUI - SWITZERLAND
5	DENDAS RIGO	KARATE VLAANDEREN		BEL - BELGIUM
7	BEZEMER BRADLEY	SPORTSCHOOL MUILWIJK		NED - NETHERLANDS
7	FAGERLI DEMIAN	SPORTSKARATE DRAMMEN		NOR - NORWAY

Kumite Male U16 -70kg				
1	VAN KRUIJNING FLYNN	UNITY99		NED - NETHERLANDS
2	PIERANTONI MATTEO	KARATÉ CLUB NIEDERANVEN		LUX - LUXEMBOURG
3	NEDIOGLO DIMITRII	KARATE CLUB STRASSEN		LUX - LUXEMBOURG
3	BLUMINK LEVY	KARATESCHOOL FIGHTIN NABIL		NED - NETHERLANDS
5	SAUTELET ARTHUR	KARATÉ CLUB BAUDOUR ASBL		BEL - BELGIUM
5	EL-AIDI YAHYA	SHINOBI KARATÉ CLUB		BEL - BELGIUM
7	DE WILDE SENNE	VORIS KARATE SCHOTEN		BEL - BELGIUM

Kumite Male U18 +76kg				
1	DAVIES ALEXANDER	KARATÉ CLUB NIEDERANVEN		LUX - LUXEMBOURG
2	ANISIMOV VLADISLAV	ACADÉMIE KARATÉ LEPONCE		BEL - BELGIUM
3	VAN DER VLIET MERIJN	UNITY99		NED - NETHERLANDS

Official Results

3	VAN WOUDEBERG MIKA	KARATE TEAM UTRECHT		NED - NETHERLANDS	
5	BANDELIER MATHIS	SWISS KARATE UNION		SUI - SWITZERLAND	
5	MAYR WERNER	LZ OBERÖSTERREICH		AUT - AUSTRIA	

Kumite Male U18 -55kg

1	TO NICOLAS	UNITY99		NED - NETHERLANDS	
2	COIMBRA POL	KARATE CLUB STRASSEN		LUX - LUXEMBOURG	
3	BLACK JOSEPH	KAISHO KARATE		ENG - ENGLAND	
3	KELLY TOMAS	I.K.K.U.		IRL - IRELAND	
5	COSSE ETIENNE	SSKF KARATE TEAM		SUI - SWITZERLAND	
5	BOSCH DAVID	KARATESCHULE SURSEE		SUI - SWITZERLAND	

Kumite Male U18 -61kg

1	ACHGHOUYAB SAMY	KARATESCHOOL FIGHTIN NABIL		NED - NETHERLANDS	
2	KELLY CATHAL	I.K.K.U.		IRL - IRELAND	
3	BECHTIOUI TAHA	UNITED SPORTCENTER		SWE - SWEDEN	
3	PERSAUD MATTHEW	KARATEKENAMJU HAARLEM		NED - NETHERLANDS	
5	WINTERSPERGER LORENZ	LZ OBERÖSTERREICH		AUT - AUSTRIA	
5	KABASHI ELSON JASON	ELSON SPORT & KARATE		SUI - SWITZERLAND	
7	WENGER LEVIN	SWISS KARATE UNION		SUI - SWITZERLAND	
7	VERHUYGHT KENNY	KARATE VLAANDEREN		BEL - BELGIUM	

Kumite Male U18 -68kg

1	TORRES STEVEN	SSKF KARATE TEAM		SUI - SWITZERLAND	
2	LORENZ SWAN	KARATE CLUB VALAIS		SUI - SWITZERLAND	
3	KRIJNEN THOMAS	UNITY99		NED - NETHERLANDS	
3	WERFF KAI	UNITY99		NED - NETHERLANDS	
5	RIBEIRO DIOGO	KSVA - PORTUGAL		POR - PORTUGAL	
5	ALVES LUCAS	CENTRO BUDO DE FAFE		POR - PORTUGAL	
7	TSCHARNER LOAN	KARATEDO LYSS- AARBERG		SUI - SWITZERLAND	
7	KNAROV MAXENCE	KARATE CLUB STRASSEN		LUX - LUXEMBOURG	



Kumite Male U18 -76kg

1	SERRA TIAGO	KARATÉ CLUB NIEDERANVEN		LUX - LUXEMBOURG	
2	BUHURCU JIYAN	KARATE DO BRUGG		SUI - SWITZERLAND	
3	MEZRAUI OMAR	KARATE TEAM UTRECHT		NED - NETHERLANDS	
3	RIBEIRO FRANCISCO	KSVA - PORTUGAL		POR - PORTUGAL	

Official Results

5	VOGEL KASPAR	SWISS KARATE UNION		SUI - SWITZERLAND	
5	HALBICH NICOLAS	SWISS KARATE UNION		SUI - SWITZERLAND	

Kumite Male U21 - 60kg

1	COIMBRA POL	KARATE CLUB STRASSEN		LUX - LUXEMBOURG	
2	LANG MARCUS	LEISTUNGSZENTRUM WIEN		AUT - AUSTRIA	
3	HANSEN HENRIK WALSTAD	SPORTSKARATE DRAMMEN		NOR - NORWAY	

Kumite Male U21 - 67kg

1	EJJA AMINE	CHAMPIONS CLUB		BEL - BELGIUM	
2	BOUZHACHAH ISSHAK-MOHAMED	ACADÉMIE KARATE NEUPRÉ		BEL - BELGIUM	
3	JOST RUBEN	KARATEDO LYSS-AARBERG		SUI - SWITZERLAND	
3	MONK LUKE	EMPRISE ACADEMY		ENG - ENGLAND	
5	ROUBOS SEAN	SPORTSCHOOL MUILWIJK		NED - NETHERLANDS	
5	CHOUVIN PAUL	SPORTING KARATÉ BUDO ELITE		FRA - FRANCE	

Kumite Male U21 - 75kg

1	SIBILLE JORDAN	KARATE CLUB DIFFERDANGE		LUX - LUXEMBOURG	
2	ROLAND TOM	KARATE CLUB 31		BEL - BELGIUM	
3	GRIGORASENCO NICHITA	LZ OBERÖSTERREICH		AUT - AUSTRIA	
3	ALMALH MAHMOUD	KARATE CLUB DIFFERDANGE		LUX - LUXEMBOURG	
5	VRANJES ANDREJ	KARATE DO BRUGG		SUI - SWITZERLAND	
5	BARANYI BARNABAS	KARATE DO BRUGG		SUI - SWITZERLAND	
7	SPARER NICO	SSKF KARATE TEAM		SUI - SWITZERLAND	
7	TERLICA GOMES SEBASTIEN	CHINTO KAYL		LUX - LUXEMBOURG	

Kumite Male U21 -84kg/+84kg

1	ANISIMOV DANYIL	ACADÉMIE KARATÉ LEPONCE		BEL - BELGIUM	
2	KABASHI JOHN	ELSON SPORT & KARATE		SUI - SWITZERLAND	
3	ROUËCHE DAVID	SWISS KARATE UNION		SUI - SWITZERLAND	
3	DOBBERSTEIN LENNOX	KARATE DO BRUGG		SUI - SWITZERLAND	
5	FERNANDES FÁBIO	CENTRO BUDO DE FAFE		POR - PORTUGAL	

Kumite female U14 - 42kg

1	ALTENHOF MIRA	KV NORDHORN		GER - GERMANY	
2	KANESAN ALYCIA	KARATEDO LYSS-AARBERG		SUI - SWITZERLAND	
3	LU JAIMI	RENE SMAAL KARATE		NED - NETHERLANDS	

Official Results

3	BAUMGÄRTNER LARA	TEAM FIGHTCLUB WESTERWALD		GER - GERMANY	
5	VERGA LUDIVINE	KARATE CLUB FRIBOURG		SUI - SWITZERLAND	
5	WIDMER ALISHA	KARATECENTER RETO KERN KREUZLINGEN		SUI - SWITZERLAND	
7	NAKANO MATHILDE	KARATE CLUB STRASSEN		LUX - LUXEMBOURG	

















Lion Cup 2024 Luxembourg - 2024-06-07

Medals - Club

Rank	Club	1. Place	2. Place	3. Place
1	 UNITY99, NED	6	2	4
2	 KARATESCHOOL FIGHTIN NABIL, NED	5	4	4
3	 CHAMPIONS CLUB, BEL	4	1	3
4	 QUIRICI2020, SUI	3	2	1
5	 KARATÉ CLUB NIEDERANVEN, LUX	3	2	0
6	 ACADÉMIE KARATÉ LEPONCE, BEL	3	1	1
7	 KARATE CLUB STRASSEN, LUX	2	11	10
8	 SPORTING KARATÉ BUDO ELITE, FRA	2	3	5
9	 A.A.S.S. KARATE SARCELLES, FRA	2	3	0
10	 SWISS KARATE UNION, SUI	2	1	4
11	 KV NORDHORN, GER	2	1	0
12	 SSKF KARATE TEAM, SUI	2	0	3
13	 KARATE VLAANDEREN, BEL	2	0	2
14	 KARATE CLUB DE VILLEPINTE ET OMNISPORTS, FRA	2	0	0
	 KARATE EMME, SUI	2	0	0
16	 KARATEKENAMJU HAARLEM, NED	1	2	4
17	 KARATECENTER RETO KERN KREUZLINGEN, SUI	1	1	2
	 CHARDON, BEL	1	1	2
19	 USLM KARATÉ MONT-SAINT-MARTIN, FRA	1	1	1
20	 ELSON SPORT & KARATE, SUI	1	1	0
	 KARATE MOSSEL-BOOT, NED	1	1	0
	 ACADÉMIE KARATE NEUPRÉ, BEL	1	1	0
	 KARATE CLUB VALAIS, SUI	1	1	0
24	 KARATE CLUB DIFFERDANGE, LUX	1	0	4
25	 VORIS KARATE SCHOTEN, BEL	1	0	3
	 KARATE TEAM UTRECHT, NED	1	0	3
27	 KC WALFER, LUX	1	0	2
28	 KARATESCHOOL ALKEN, NED	1	0	1
	 EKTS LAUSANNE VUFFLENS, SUI	1	0	1
	 TEAM FIGHTCLUB WESTERWALD, GER	1	0	1
	 KARATE CLUB ANDENNE-SEILLES, BEL	1	0	1
	 LZ OBERÖSTERREICH, AUT	1	0	1
33	 KARATE-SPORT-CENTER FREUDENSTADT, GER	1	0	0
	 BUDOSCHOOL KAI SEI, NED	1	0	0
	 KAMIGAITO WADO RYU KARATE MAMER, LUX	1	0	0
	 CHINTO KAYL, LUX	1	0	0
37	 KARATE DO BRUGG, SUI	0	3	2
38	 CHOKU-ZAANDAM, NED	0	3	1
39	 KARATEDO LYSS-AARBERG, SUI	0	2	6
40	 SHOTOKAN - KARATE SAARWELLINGEN E.V., GER	0	2	1
41	 SPORTSKARATE DRAMMEN, NOR	0	1	4
42	 KARATE CLUB 31, BEL	0	1	3
43	 KARATE-DO BUITENVELDERT, NED	0	1	2
	 LEISTUNGSZENTRUM WIEN, AUT	0	1	2
45	 KARATE CLUB LINTGEN, LUX	0	1	1
	 KARATE MOERDIJK, NED	0	1	1
	 I.K.K.U., IRL	0	1	1

Lion Cup 2024 Luxembourg - 2024-06-07

Medals - Club

48	 KC SAMOERAI LEUVEN, BEL	0	1	0
	 WSKF SENSHI, IRL	0	1	0
	 BVL FIGHTING, NED	0	1	0
	 ECOLE MARTIAL FIGHT PRO, BEL	0	1	0
	 KARATECLUB KACHI NINOVE, BEL	0	1	0
	 SPORTSKARATE.FI, FIN	0	1	0
54	 KARATE CLUB DE CHARENTON - SAINT-MAURICE, FRA	0	0	3
	 GEOFFREY BERENS KARATE ACADEMY, NED	0	0	3
56	 WAKAI TEAM, BEL	0	0	2
	 KARATESCHULE SURSEE, SUI	0	0	2
	 SHINOBI KARATÉ CLUB, BEL	0	0	2
	 YAMATSUKI-KARATÉ BRUXELLES, BEL	0	0	2
	 KARATE-DO LONGWY, FRA	0	0	2
61	 CENTRO BUDO DE FAFE, POR	0	0	1
	 TUREBERGS KARATEKLUBB, SWE	0	0	1
	 GOJU KAN BERN, SUI	0	0	1
	 SHOTOKAN KARATÉ CLUB VERDUN, FRA	0	0	1
	 SPORTSCHOOL VAN DEN NIEUWENDIJK, NED	0	0	1
	 KARATESCHOOL BU SHIN KAN, NED	0	0	1
	 USI KARATE, FRA	0	0	1
	 KARATÉ CLUB WALLONIE, BEL	0	0	1
	 GYMNASSTIK OCH ATLETKLUBBEN ENIGHET, SWE	0	0	1
	 SPORTSCHOOL MUILWIJK, NED	0	0	1
	 KARATE TEAM SONNEMA, NED	0	0	1
	 KAISHO KARATE, ENG	0	0	1
	 CKMAIA, POR	0	0	1
	 UNITED SPORTCENTER, SWE	0	0	1
	 KSPA - PORTUGAL, POR	0	0	1
	 EMPRISE ACADEMY, ENG	0	0	1
	 RENE SMAAL KARATE, NED	0	0	1